



Product information



Technical documents
Download from PRO CLUB

Panasonic®

Building Passion, Building Solutions. Panasonic Air Conditioning Systems

We face a time in which "quality air" differentiates business. It's a time for Panasonic to fully display its strengths. Our ability to assemble and build superior systems isn't just due to the rich resources we have as a comprehensive electronics manufacturer, but also to Panasonic's 100 years of tradition, where each person thinks and acts on their own initiative while working in a team to reach further heights. We do not compromise. Each of our independent selves is a one stop solution. We face our customers' challenges together with our customers and do all that we can to build effective systems. As a true partner for our customers, we strive to always be at the forefront of business.

- Please read the Installation Instructions carefully before installing the unit, and the Operating Instructions before using it.
- Specifications are subject to change without prior notice.
- The contents of this catalogue are accurate as of July 2023.
- Due to printing considerations, actual colours may vary slightly from those shown.
- All graphics are provided solely for the purpose of illustrating a point.



Do not add or replace refrigerant other than the specified type. Manufacturer is not responsible for damage or deterioration in safety due to usage of other refrigerant.

Authorised Dealer

VRF AU_ JULY 2023

Panasonic Australia Pty. Limited.

Address: 1 Innovation Road, Macquarie Park, NSW 2113
ACN 001 592 187 ABN 83 001 592 187
aircon.panasonic.com.au

VRF SYSTEMS



Residential &
Light Commercial Use

R32



FSV

Residential &
Light Commercial Use

R410A



FSV EX

Commercial Use

R410A



QUALITY AIR FOR LIFE

THE GAME CHANGER



ALL INVERTER

FSV-EX with Extraordinary Energy-Saving Performance and Powerful Operation

EER 4.87*

*IN THE CASE OF U-8MF3R7

A game-changing FSV-EX system delivering energy-saving performance, powerful operation, reliability and comfort surpassing anything previously possible.

It represents a true paradigm shift in air conditioning solutions.

Taking quality to the extreme — that's the Panasonic challenge.

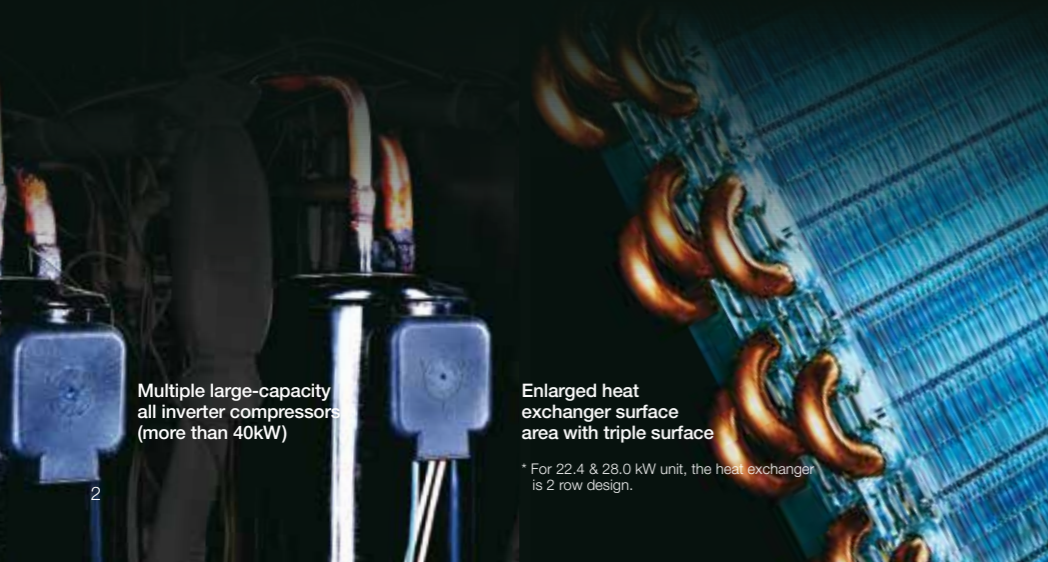

Multiple large-capacity all inverter compressors (more than 40kW)



Enlarged heat exchanger surface area with triple surface

* For 22.4 & 28.0 kW unit, the heat exchanger is 2 row design.



Newly designed curved air discharge bell mouth for better aerodynamics

Panasonic
FSV-EX
GAMMA

Extraordinary

4.87 **EER**

IN THE CASE OF U-8MF3R7

CONTENTS

02 FSV-EX Introduction	70 Indoor Units	110 Smart Connectivity and Control Solutions
04 Mini-VRF LE/LZ Introduction	72 Indoor Units Range	114 Panasonic Comfort Cloud
06 FSV-EX Advantages	74 F3 Type / Mid Static Adaptive Ducted	116 VRF Smart Connectivity+
08 FSV-EX Series / Exclusive Feature 1 Extended Operation Range	78 M1 Type / Slim Low Static Ducted	118 Panasonic AC Smart Cloud
10 FSV-EX Series / Exclusive Feature 2 Energy-Saving Performance	80 Z1 Type / Slim & Narrow Ducted	120 Controllers
12 FSV-EX Series / Exclusive Feature 3 Oil Management System	82 E2 Type / High Static Ducted	123 Individual Control Systems
14 Exclusive Feature / Panasonic VRF: Top In Comfort	84 E2 Type / Energy Saving High Fresh Air Ducted	126 Centralised Control Systems
16 Exclusive Feature / CAC Design Support Software	86 E1 Type / High Static Ducted	130 T10 Terminal for External Control
18 VRF Systems	88 K2 Type / Wall Mounted	131 Interfaces for External Control
20 2-PIPE FSV-EX ME2 Series	92 U2 Type / 4-Way Cassette	132 Serial Interface for 3rd Party External Controller
38 3-PIPE FSV-EX MF3 Series	96 Y3 Type / 4-Way Mini Cassette	133 Serial Interface for LonWorks Network
54 2-PIPE Mini-VRF LE/LZ Series	98 L1 Type / 2-Way Cassette	134 FSV Controller External Dimensions
66 nanoe™ X Air Purification	100 D1 Type / 1-Way Cassette	136 VRF R22 Renewal
68 Smart Comfort with CONEX	102 T2 Type / Under Ceiling	140 A Globally Trusted Air Conditioning Brand
	104 G1 Type / Floor Console	142 Reliability and Durability
	106 P1 Type / Floor Standing	144 Global Networking of Air Conditioning Solutions
	108 R1 Type / Concealed Floor Standing	146 Panasonic VRF Global Project References

MINI GAME CHANGER

INVERTER

Mini-VRF LE/LZ Series Cooling & Heating Type

Mini-VRF with Extraordinary Energy-Saving Performance
and High External Static Pressure(35Pa)

High External Static
Pressure 35Pa

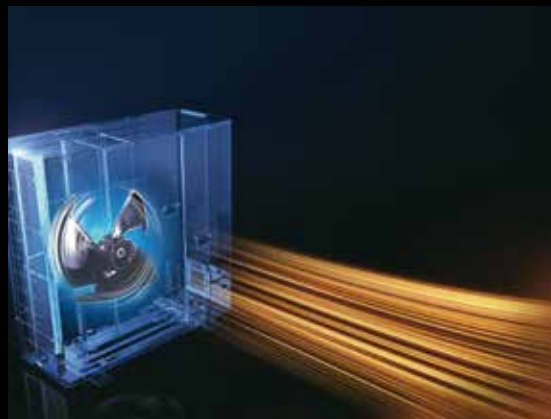

Compact Design



LE1 Series
22.4/25.0 kW

3.80^{*}
EER

* In the case of 22.4 kW

R410A

LE2 Series
12.1/14.0/15.5 kW

4.50^{*}
EER

* In the case of 12.1 kW

LZ2 Series
22.4/28.0 kW

3.84^{*}
EER

* In the case of 22.4 kW

R32
REFRIGERANT

LZ2 Series
12.1/14.0/15.5 kW

4.53^{*}
EER

* In the case of 12.1 kW

FSV-EX Advantages



Most efficient, powerful and quiet system in Panasonic's history.

Extraordinary Energy-Saving Performance

The FSV-EX marks a revolutionary step forward in VRF efficiency. A look at the incredible EER value clearly indicates that. What's more, this high EER value is achieved even during part load operation. This shows the extraordinary energy-saving performance the FSV-EX is capable of providing.

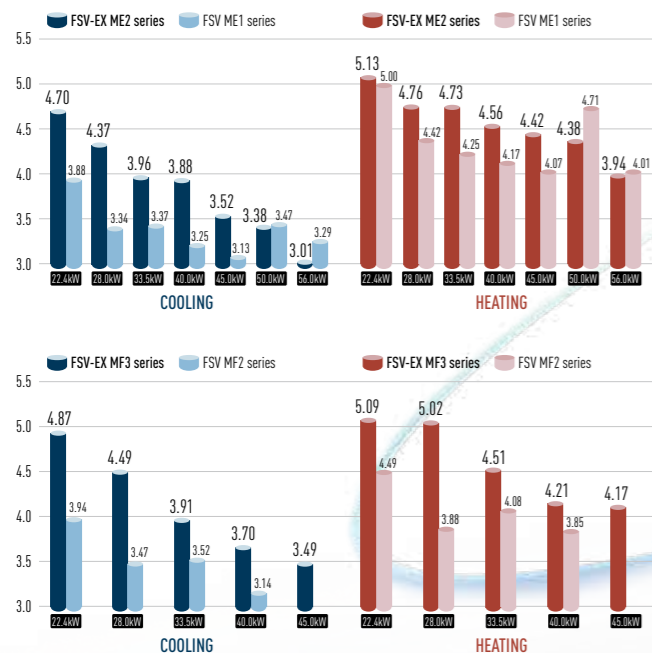

Extended Operation Range Up to 52°C

The FSV-EX can provide cooling even when the outside temperatures up to 52°C. And amazingly, it can still operate at 100% capacity when the outside temperature is as high as 43°C. This high power capability enables reliable operation even under extremely high temperature conditions.

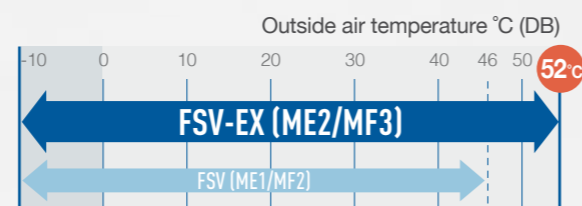

Low-Noise Operation

Numerous technological innovations, including an improved compressor and a newly designed bell mouth and larger fan, have dramatically reduced the outdoor noise level. The result is an even more comfortable building environment.

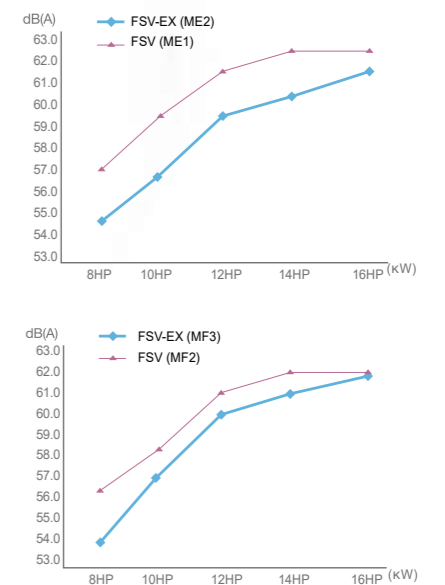

Multiple large-capacity all inverter compressors

(more than 40kW)

Two independently controlled inverter compressors achieve high efficiency. Redesigned components in the body provide performance improvement especially in the rated cooling condition and EER performance.



Enlarged heat exchanger surface area with triple surface*

The new heat exchanger features a triple-surface construction. Compared to the divided dual-surface construction in current models, there is no division of space and the area for heat exchange is larger. Also, highly efficient piping pattern increases heat exchange performance by 5%.^{*1}



* For 22.4 & 28.0kW unit, the heat exchanger is 2 row design.
*1 Based on Panasonic in-house report

Extended Operation Range -25°C* to 52°C



High reliability even under high temperature conditions

Designed to be durable enough to withstand extreme heat, FSV EX ensures reliable cooling operation over an extended operation range up to 52°C.

OPERATING RANGE

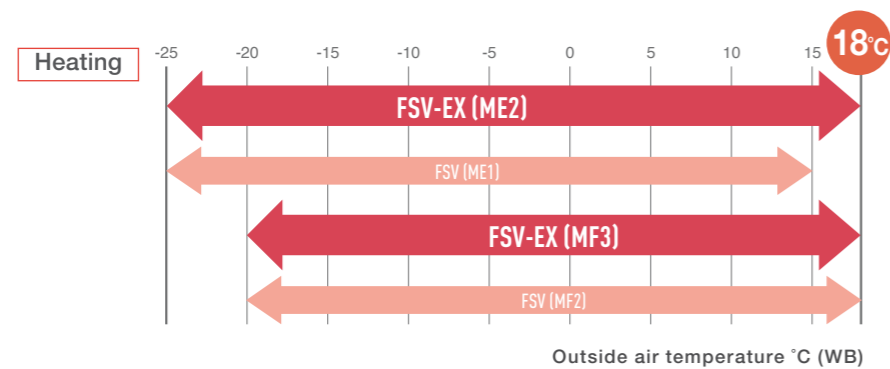
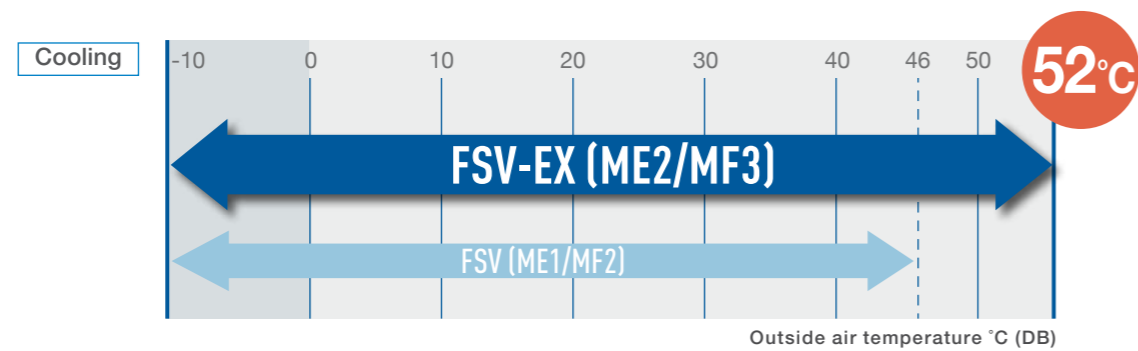

Full-capacity Operation up to 43°C

The FSV-EX can provide cooling even when the outside temperatures up to 52°C.

And amazingly, it can still operate at 100% capacity when the outside temperature is as high as 43°C.

This high power capability enables reliable operation even under extremely high temperature conditions.

CAPACITY RATIO (COOLING)

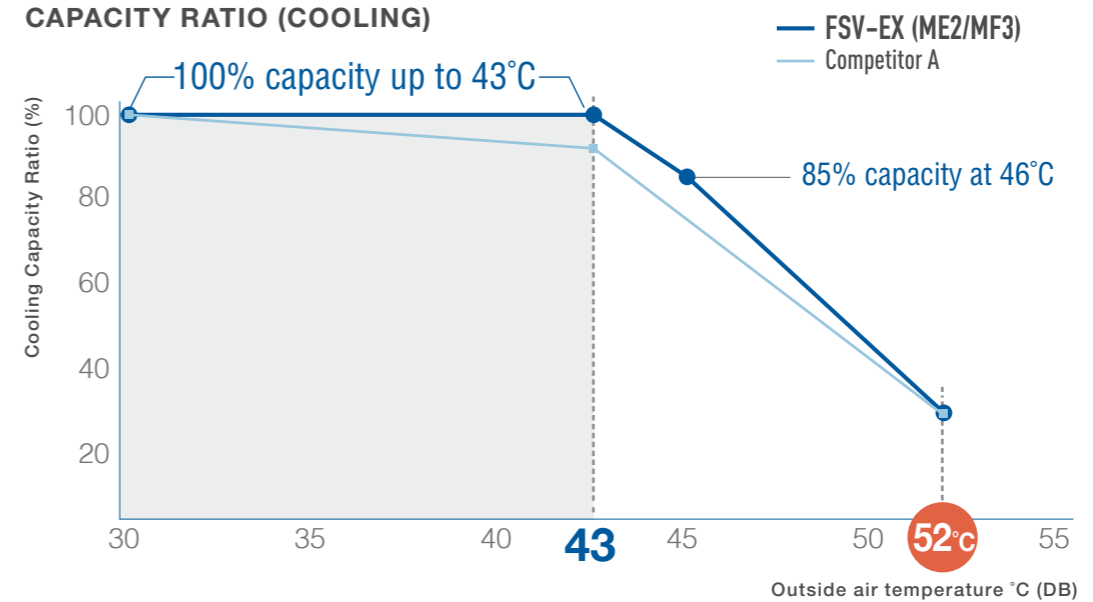

<Test Condition> 33.5kW model, IU/OU capacity ratio:100%, Indoor Condition:27°C[DB]/19°C[WB]
Competitor A spec is from technical data book.



Extraordinary Energy-Saving Performance



Designed for Actual Operation Performance

Panasonic builds air conditioning systems not only with a high EER for rated operation, but also with Seasonal-EER appropriate to the customer's actual environment of use. For instance, with rated operation, outdoor temperature is constant at 35°C, but in reality the outdoor temperature is continuously changing. Consequently, required air conditioning performance also changes. That's why Panasonic implements the following kind of proprietary control.

1. Set temperature is rapidly attained; full-load operating time is kept to a minimum.
2. The frequency of forced oil recovery is minimised. The volume of oil within the compressors is monitored precisely by sensors, so forced oil recovery under full-load operation is conducted only when necessary. Since this suppresses noise due to oil recovery, comfort is maintained.
3. Panasonic pursues a high EER, of course, as well as high EER in part load, for energy saving performance under a broad range of loads.

Panasonic's design concept contributes to substantial energy cost reductions.

Rapidly reaches set temperature
→ full-load operation duration minimised

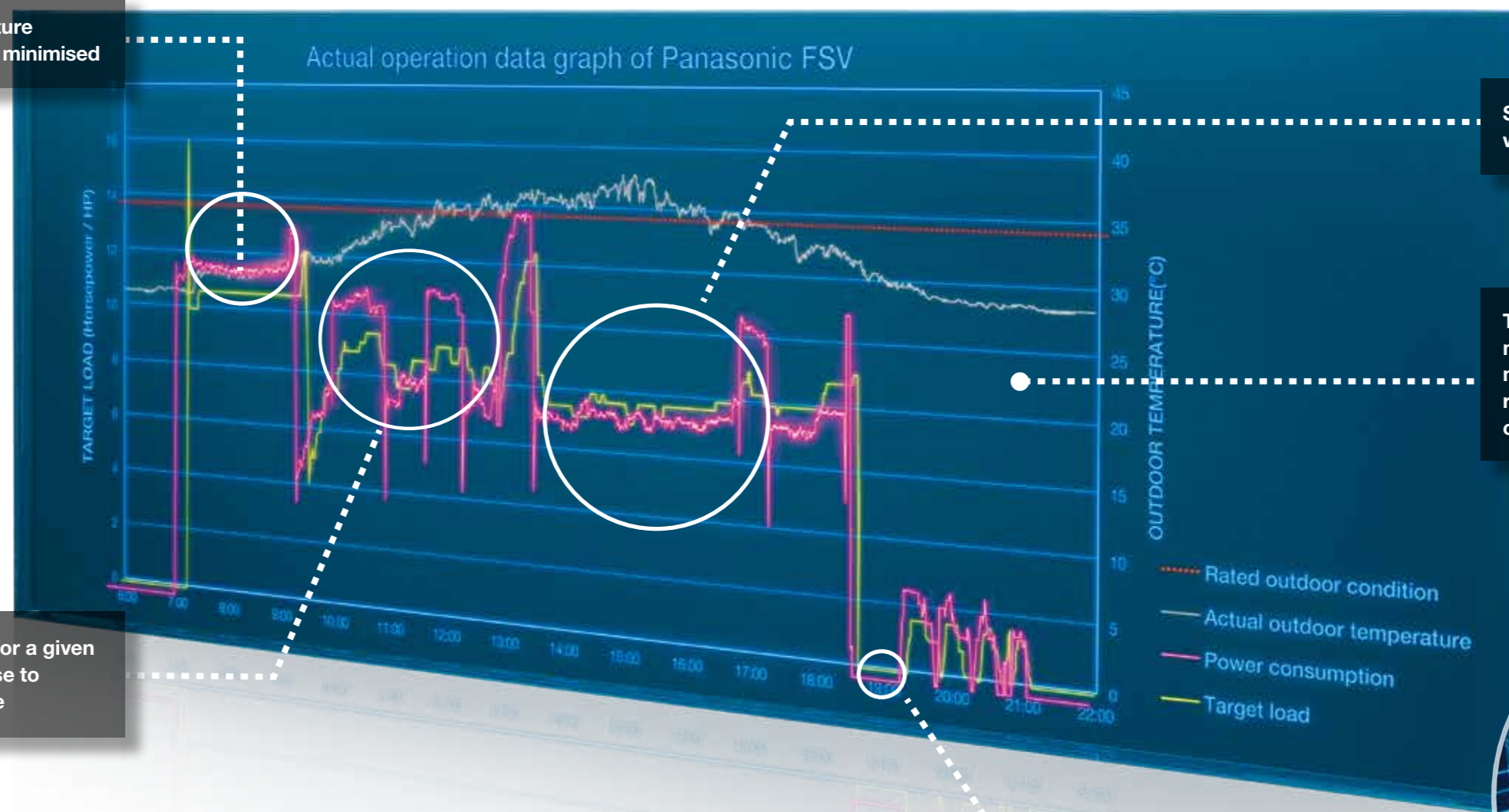

Set temperature maintained with minimum load operation

Thanks to superior oil management, oil recovery is minimised, contributing to reduced energy use and costs

Load increased as required for a given outdoor temperature increase to maintain the set temperature

When outdoor temperature drops, operation is immediately stopped

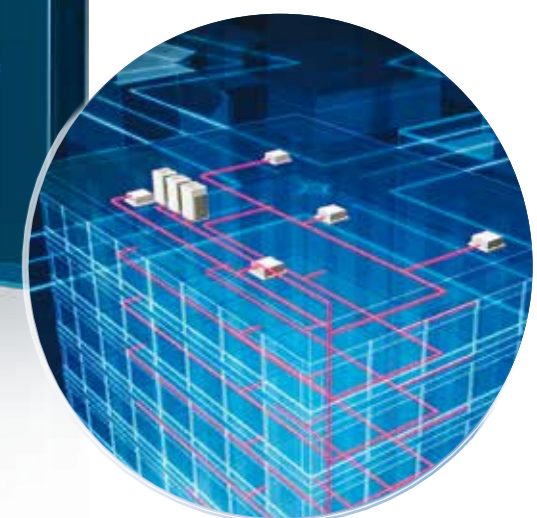

Actual performance data of Panasonic FSV-EX installed in Asia

Simulated conditions
Location: Panasonic building in Malaysia System: One 45.0kW outdoor unit, 4 cassette-type indoor units

Intelligent 3-stage Oil Management System



In a VRF system, where lengthy piping and a large number of indoor units need to be controlled collectively, the key to maintaining the system's reliability is to ensure an appropriate amount of oil is secured in the compressors. In order to avoid oil shortage in the compressor, maximum operation is normally forcibly conducted at regular intervals to recover oil from indoor units. This method, typically employed in a standard VRF, causes the system to overheat or overcool and thus waste energy.

In Panasonic FSV-EX systems, temperature sensors detect oil level in each compressor.

In installations with multiple outdoor units, a shortage of oil in one compressor can be compensated for by recovering oil either from another compressor in the same unit, from a compressor in an adjacent outdoor unit, or from a connected indoor unit. Panasonic VRF systems provide users with a comfortable environment whilst saving energy.

The Panasonic system efficiently manages oil recovery in three stages; minimising the frequency of forced oil recovery while reducing energy cost and maintaining comfort.

STAGE-1

Temperature sensor monitor oil levels in each compressor precisely all the time. If oil levels fall, oil can be transferred from other compressors within the same outdoor unit.



STAGE-2

If oil levels in all compressors within the outdoor unit fall, oil can be replenished from adjacent outdoor units.

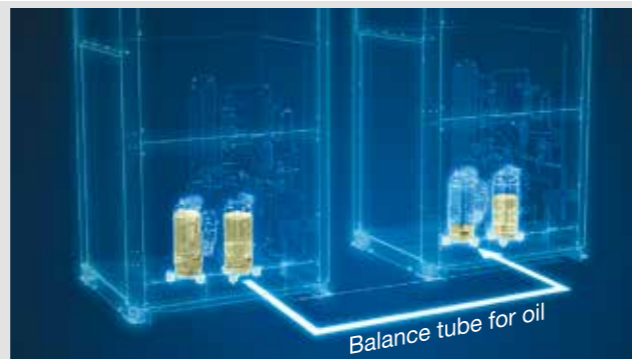

STAGE-3

Forced oil recovery is implemented only if oil levels become insufficient in spite of above measures. The Panasonic system's design concept is radically different from conventional oil systems.

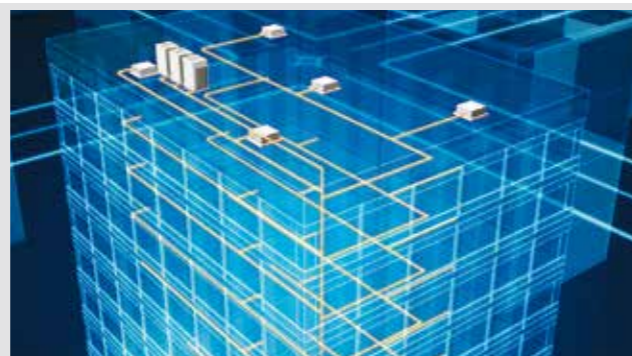

Features of 3-stage oil recovery design

1 Temperature sensor to monitor each compressor

Temperature sensor monitor oil levels in each compressor precisely, eliminating unnecessary oil recovery.



2 Highly functional oil separator

Thanks to extended separate piping, oil recovery efficiency reaches 90%, minimising the oil to be discharged from the compressor.

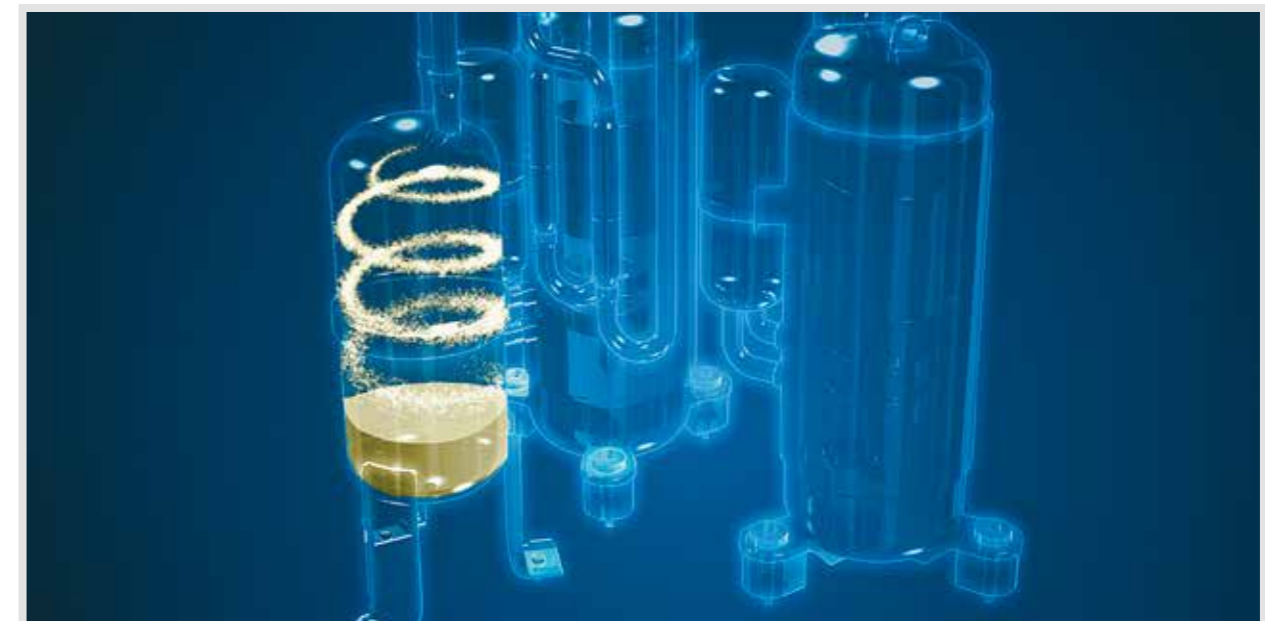

Panasonic VRF: Top In Comfort

Energy savings × Comfortable air conditioning ~Variable Evaporation Temperature (VET)~

Since 2006, all Panasonic VRF systems have included special VET technology, with variable refrigerant temperature, as standard. Our 'smart logic' system checks the temperature every 30 seconds, automatically adjusting the refrigerant temperature according to actual demand and outdoor conditions.

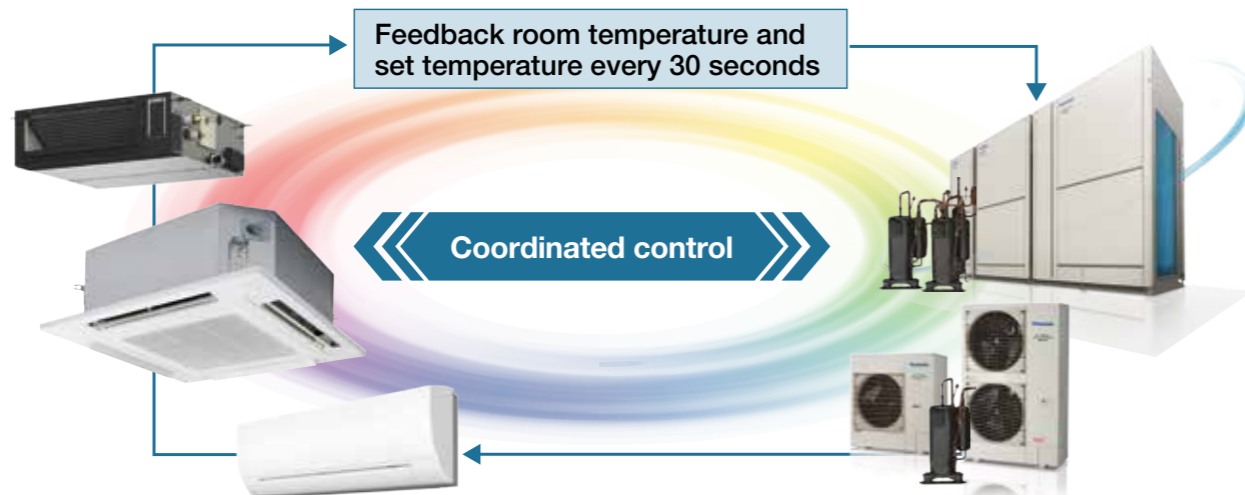

Calculate indoor refrigerant temperature and control the airflow automatically based on the difference between the setting temperature and actual indoor temperature.

Determine system refrigerant temperature and control compressor speed.

* When fan speed is Auto.

Achieves room-by-room comfort and overall system energy savings by controlling optimal refrigerant temperature and circulation volume based on all information of the entire system.

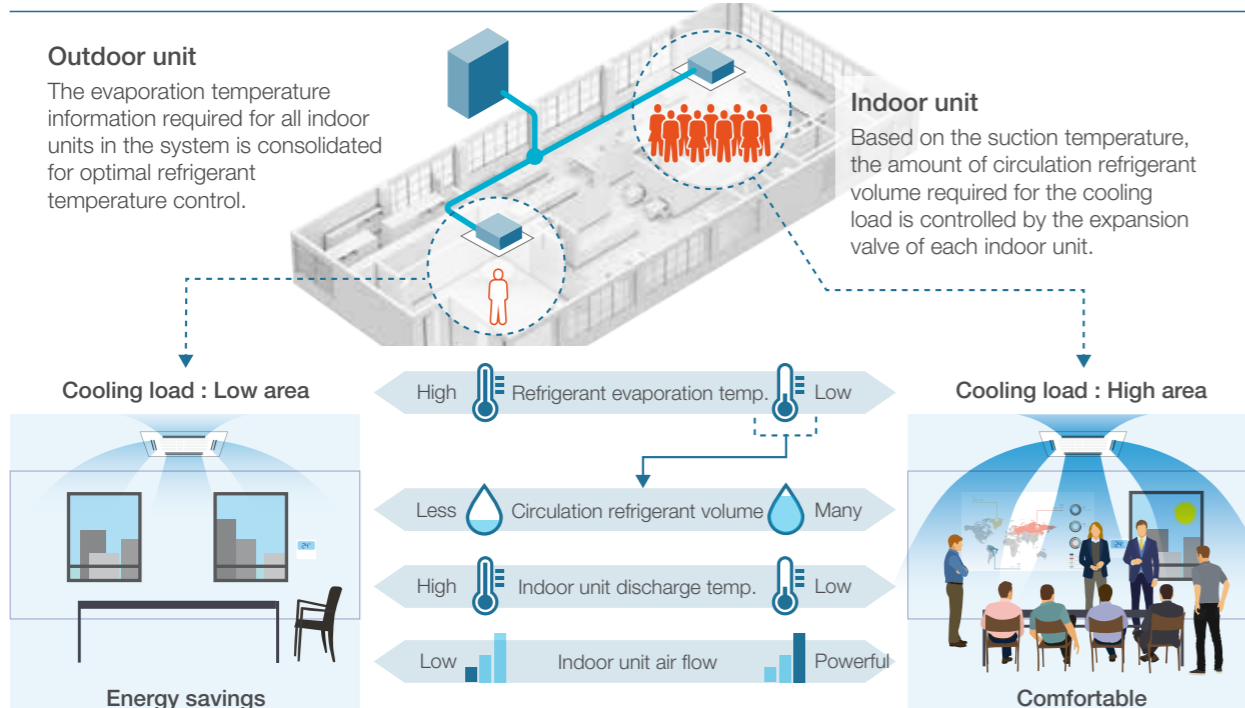

Combination of VET technology and inverter compressor achieves both energy savings and comfort by smoothly controlling the compressor to match the air conditioning load without stopping the compressor for optimum performance.

Image of room temperature change during cooling operation by scene.

1) Normal environment

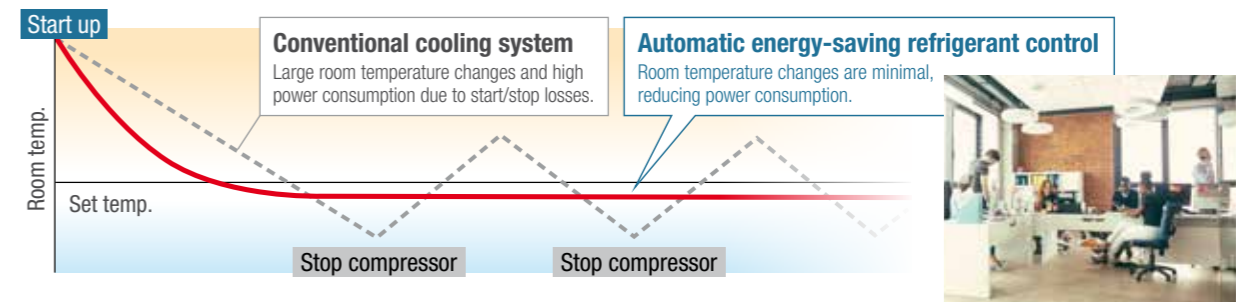

2) Environment with severe cooling load

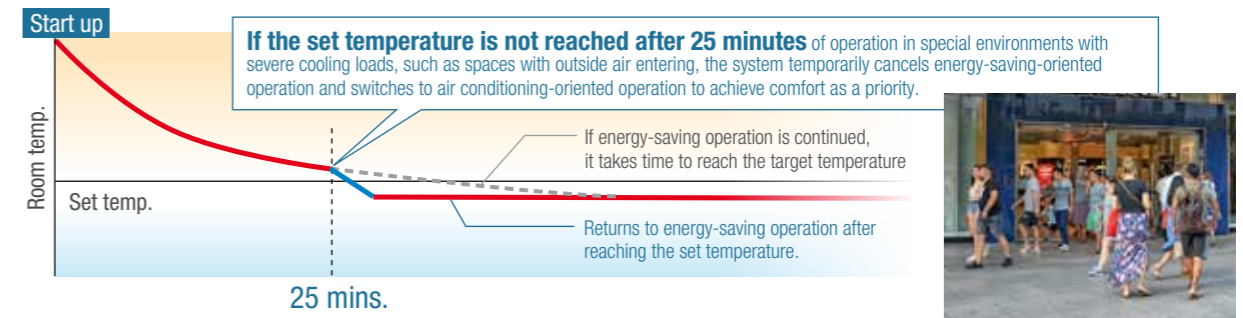

Commercial Air Conditioner Design Support Software



Download from PRO CLUB



Features the unique Drawing Capture Mode function providing More thorough spec-in and tender quotation support for easier, Faster completion of work.

Drawing Capture Mode Diagram

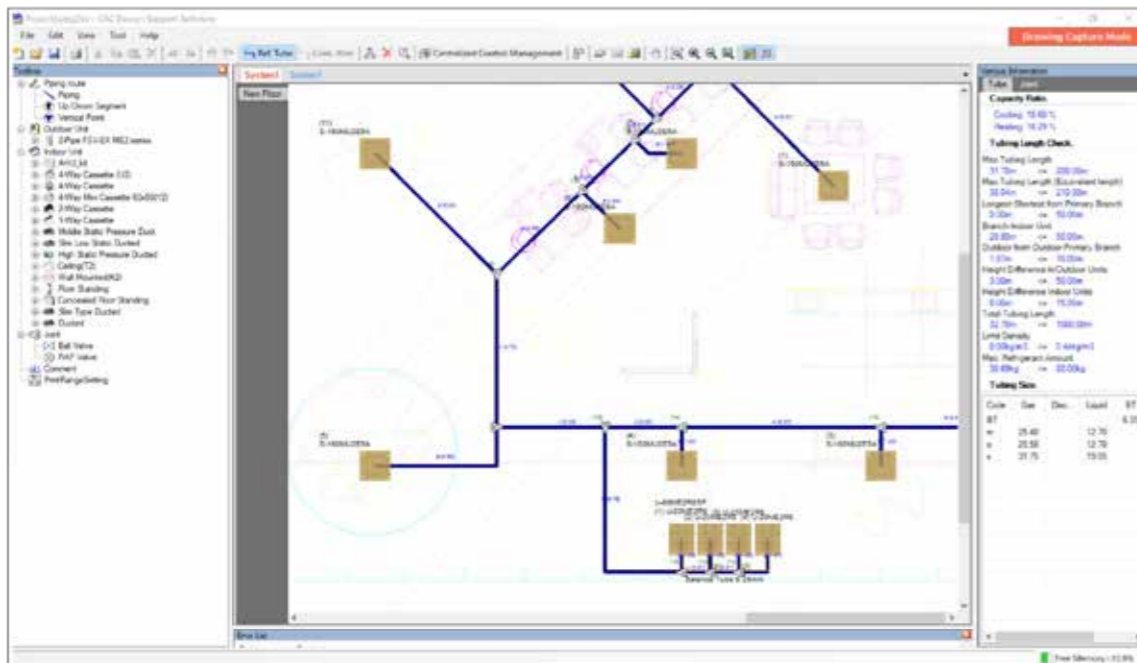

Schematic Mode Diagram

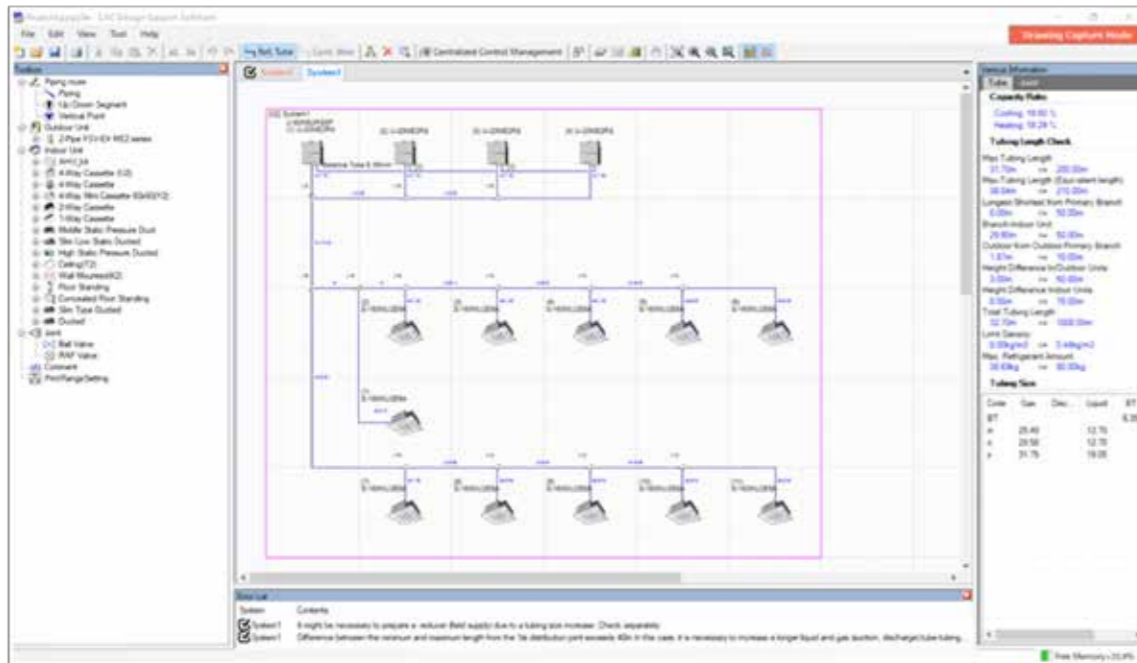

The Panasonic Commercial Air Conditioner Design Support software can be used for all Panasonic FSV

Panasonic has identified the importance of ever-increasing demands for fast and accurate responses to customer requests in our industry. More and more emphasis is being placed upon energy-efficiency in our marketplace. The ability to calculate cooling/heating loads and produce information of actual design conditions is a major advantage to any architect, consultant, contractor or end user. Panasonic understands the time-poor and demanding industry we are in and we are pleased to announce the launch of the next generation of our system design software program. The Panasonic CAC Design Support Software has been customized to make the selection and design process as quick and easy as possible. The design package utilizes system wizards and import tools to enable both simple and complex systems to be created. In addition, the system will allow outdoor and indoor units to be dragged on an interactive desktop. This allows users to create everything from realistic floor plans with detailed piping and wiring schematics to send out with quotations, through to installation guidance drawings.

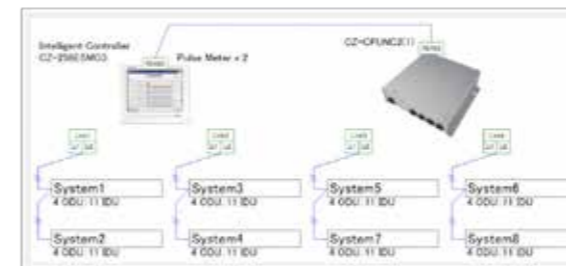
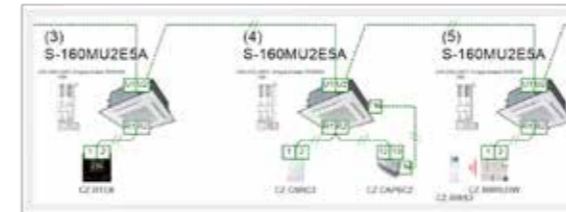

No.	Room No.	Room Name	Area (m ²)	Room Volume (m ³)	Room Height (m)	Room Temp. (°C)	Room Humidity (%)	Room Orientation	Room Usage	Room Occupancy	Room Equipment	Room Cooling Load (kW)	Room Heating Load (kW)	Room Total Load (kW)
1	101	Office	10.0	30.0	3.0	25.0	50.0	South	Office	10	1000	10.0	0.0	10.0
2	102	Office	10.0	30.0	3.0	25.0	50.0	North	Office	10	1000	0.0	10.0	10.0
3	103	Office	10.0	30.0	3.0	25.0	50.0	East	Office	10	1000	10.0	0.0	10.0
4	104	Office	10.0	30.0	3.0	25.0	50.0	West	Office	10	1000	0.0	10.0	10.0
5	105	Office	10.0	30.0	3.0	25.0	50.0	South	Office	10	1000	10.0	0.0	10.0
6	106	Office	10.0	30.0	3.0	25.0	50.0	North	Office	10	1000	0.0	10.0	10.0
7	107	Office	10.0	30.0	3.0	25.0	50.0	East	Office	10	1000	10.0	0.0	10.0
8	108	Office	10.0	30.0	3.0	25.0	50.0	West	Office	10	1000	0.0	10.0	10.0
9	109	Office	10.0	30.0	3.0	25.0	50.0	South	Office	10	1000	10.0	0.0	10.0
10	110	Office	10.0	30.0	3.0	25.0	50.0	North	Office	10	1000	0.0	10.0	10.0
11	111	Office	10.0	30.0	3.0	25.0	50.0	East	Office	10	1000	10.0	0.0	10.0
12	112	Office	10.0	30.0	3.0	25.0	50.0	West	Office	10	1000	0.0	10.0	10.0

Features

- Drawing Capture mode
Design selection from building floor drawing.
- Any kind of drawing format. (.pdf, .dxf, .dwg, etc.)
- Conventional Schematic diagram.
- Easy to use system wizards.
- Converted duties for conditions and pipework.
- Auto(CAD) [.dxf/.dwg], Excel and PDF export.
- Detailed wiring and pipework diagrams with advising terminal number.

VRF Systems

VRF systems are designed for energy savings, high efficiency, and high durability with strong cooling power even operating at high ambient temperature. Panasonic continuously apply advanced technologies to meet the requirements of diverse situations and contribute to the creation of comfortable living spaces.

FSV EX ALL INVERTER

2-PIPE FSV-EX ME2 Series

Extraordinary energy-saving performance and powerful operation

Space-saving Combination Model

Cooling or Heating Type

Anti-Corrosion Model

- Wide range of systems from 22.4 kW to 224.0 kW
- Class-leading EER of 4.7 (22.4 kW model)
- Industry-leading low noise of 54dB (22.4 kW model)
- Cooling operation possible with outdoor temperature as high as 52 °C (DB)
- Long pipe length (up to 1,000 m)
- Up to 64 indoor units connectable
- External static pressure up to 80 Pa
- Extended operating range allows heating with outdoor as low as -25 °C (WB)
- Suitable for R22 renewal projects*

*(Please refer to technical document for further details)



R410A



High Efficiency Combination Model

Cooling or Heating Type

Anti-Corrosion Model

- Wide range of systems from 22.4 kW to 180.0 kW
 - Higher EER than the Space-saving Combination Model
- (Please refer to page 30 and 31 for details)



R410A



FSV EX ALL INVERTER

3-PIPE FSV-EX Series

For simultaneous heating and cooling operation

Cooling and Heating Simultaneous Type

- Wide range of systems from 22.4 kW to 135 kW
- Top class EER : 4.87 / COP : 5.09 (22.4 kW model)
- Longer piping length (up to 500 m)
- Increased max number of connectable indoor units (up to 52)
- External static pressure up to 80Pa
- Cooling operation is possible when outdoor temperature as high as 52 °C DB
- Operating range to provide heating at outdoor temperature as low as -20 °C WB
- Suitable for R22 renewal projects

*(Please refer to technical document for further details)



R410A

Heat Recovery Type



FSV INVERTER

2-PIPE Mini-FSV LE Series

For small-scale commercial and residential use

Cooling or Heating Type 1-phase
Cooling or Heating Type 3-phase

12.1/14.0/15.5 kW

22.4/25.0 kW

- High external static pressure 35Pa
- Top-class EER: 4.50 (12.1 kW model) / 3.80 (22.4 kW model)
- Wide operation range: Cooling: -10 °C to 46 °C DB, Heating at: -20 °C to 18 °C DB
- Maximum number of connectable indoor units : 13 (22.4/25.0 kW model)
- Actual piping length : 150m
Max. piping length : 150m (12.1/14.0/15.5 kW) / 300m (22.4/25.0 kW)
- Suitable for R22 renewal projects

(Please refer to technical document for further details)



LE2

LE1

R410A

INVERTER

2-PIPE Mini-VRF LZ Series

For small-scale commercial and residential use

Cooling or Heating Type 1-phase
Cooling or Heating Type 3-phase

12.1/14.0/15.5 kW

22.4/28.0 kW

- High external static pressure 35Pa
- Top-class EER: 4.53 (12.1 kW model) / 3.84 (22.4 kW model)
- Wide operation range: Cooling: -10 °C to 52 °C DB, Heating at: -20 °C to 18 °C DB
- Maximum number of connectable indoor units : 16 (22.4/28.0 kW model)
- Maximum allowable indoor/outdoor capacity ratio 150%
- Actual piping length : 90m (12.1/14.0/15.5 kW) / 100m (22.4/28.0 kW)
Max. piping length : 180m (12.1/14.0/15.5 kW) / 300m (22.4/28.0 kW)
- Suitable for R22 renewal projects

(Please refer to technical document for further details)



NEW

R32 REFRIGERANT

* In South Australia, demand response capability will be legally required from April 2023.

2-PIPE FSV-EX ME2

Remarkable improvement on key components



4 Flat fan guard

3 New curved bell mouth

2 Combined triple-surface heat exchanger

1 Multiple large-capacity inverter compressor (More than 40.0kW)

Extraordinary energy-saving performance

- 1 Multiple large-capacity all inverter twin rotary compressors (multiple compressors for more than 14HP)

Two independently controlled inverter compressors achieve high efficiency. Redesigned components in the body provide performance improvement especially in the rated cooling condition and EER performance.



- 2 Enlarged heat exchanger surface area with triple surface*

The new heat exchanger features a triple-surface construction. Compared to the divided dual-surface construction in current models, there is no division of space and the area for heat exchange is larger. Also, highly efficient piping pattern increases heat exchange performance by 5%.

* For 22.4 & 28.0 kW unit, the heat exchanger is 2 row design.

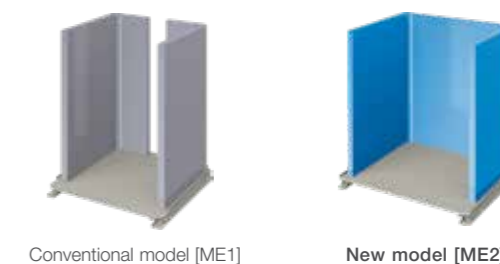

Conventional model [ME1]

New model [ME2]

Redesigned for smooth and better air discharge

- 3 Newly designed curved air discharge bell mouth for better aerodynamics

The new curved shape with integrated top and bottom assure smooth exhaust flow. This gives more air-volume with same sound level, less power input at same air-volume.

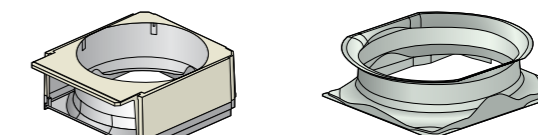

Conventional model [ME1]

New model [ME2]

- 4 Large air discharge area with new flush surface top panel

To reduce air resistance, instead of a tubular fan design, a new large flat fan guard design, flush with the top panel, is employed. This design lead to the improvements in air resistance, but also contributed to better appearance designing.



Conventional model [ME1]

New model [ME2]

High-efficiency & Space-saving VRF system

2-PIPE FSV-EX ME2

A large number of indoor units can be connected

Up to 64 indoor units can be connected in a single system for ultimate design flexibility.

*Maximum number of indoor units depends on outdoor unit capacity.

Up to 64 Indoor Units Connectable!



Increased piping length for greater design flexibility

Adaptable to various building types and sizes

Actual piping length : **200m**

(equivalent piping length : 210m)

*Elevation difference of Max. 90m in case of ODU is higher than IDU may be allowed following certain conditions. Please consult with Panasonic sales engineers in case of piping elevation of over 50m is required.

*1: 40 m if the outdoor unit is below the indoor unit.

Max. total piping length:1,000m

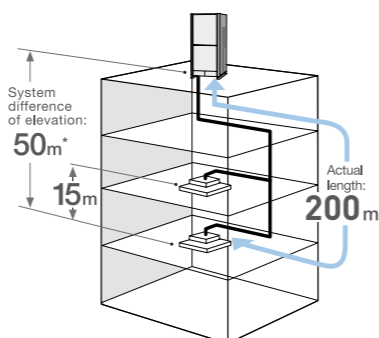

Connectable indoor/outdoor unit capacity ratio up to 130% *

FSV systems attain maximum indoor unit connection capacity of up to 130 %* of the unit's connection range, depending on the outdoor and indoor models selected. So for a reasonable investment, FSV systems provide an ideal air conditioning solution for locations where full cooling/heating are not always required.

SYSTEM / kW	22.4	28.0	33.5	40.0	45.0	50.0	56.0	61.5	68.0	73.0	78.5	85.0	90.0	96.0	101.0	107.0	113.0	118.0	124.0	
MNcIU : 130%	13	16	19	23	26	29	33	36	40	43	46	50	53	56	59	63	64	64	64	64

SYSTEM / kW	130.0	135.0	140.0	145.0	151.0	156.0	162.0	168.0	174.0	180.0	185.0	190.0	196.0	202.0	208.0	213.0	219.0	224.0
MNcIU : 130%	64	64	64	64	64	64	64	64	64	64	64	64	64	64	64	64	64	64

MNcIU : Maximum Number of Connectable Indoor Unit

Note: If more than 100% indoor units are operated with a high load, the units may not perform at the rated capacity. For the details, please consult with an authorised Panasonic dealer

* If the following conditions are satisfied, the effective range is above 130 % up to 200 %.
 i) Obey the limited number of connectable indoor units.
 ii) The lower limit of operating range for heating outdoor temperature is limited to -10°CWB (standard -25°CWB).
 iii) Simultaneous operation is limited to less than 130 % of connectable indoor units.

Excellent energy savings

The operation efficiency has been improved using highly efficient R410A refrigerant, new DC inverter compressor, and new heat exchanger design.

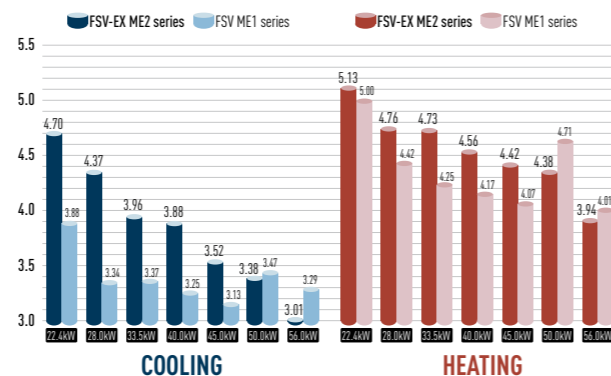

Up to 50m length difference between the longest and the shortest piping from the first branch

Flexible piping layout makes it easier to design systems for locations such as train stations, airports, schools and hospitals.

- Up to 64 units can be connected to one system.
- Difference between maximum and minimum pipe runs after first branch can be a maximum of 50m.
- Larger pipe runs can be up to 200m.

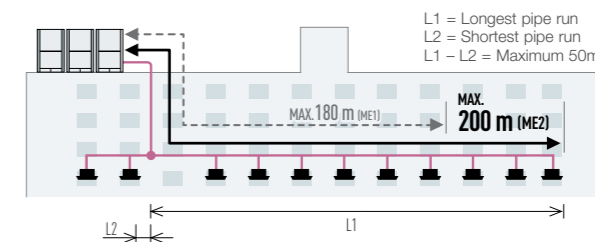

Extended operating range

Cooling operation range:

-10°C DB to +52°C DB

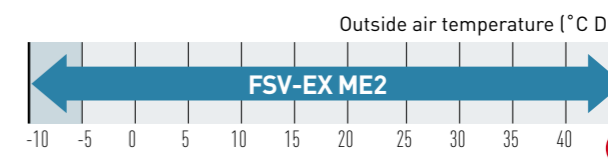

Heating operation range:

Extended heating operation range enables heating even when the outdoor temperature is as low as -25°C. Using a wired remote control, indoor heating temperature range can be set from 16°C to 30°C*.

* Depending on the type of remote controller.

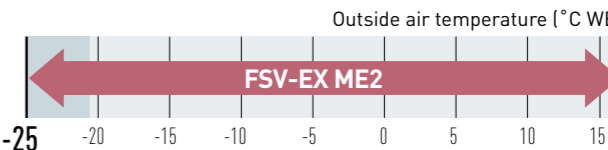

Compact design

The new ME2 series has reduced the installation space required with up to 56.0kW available in a single chassis. 22.4 - 28.0kW are able to fit inside a lift for easy handling on site.

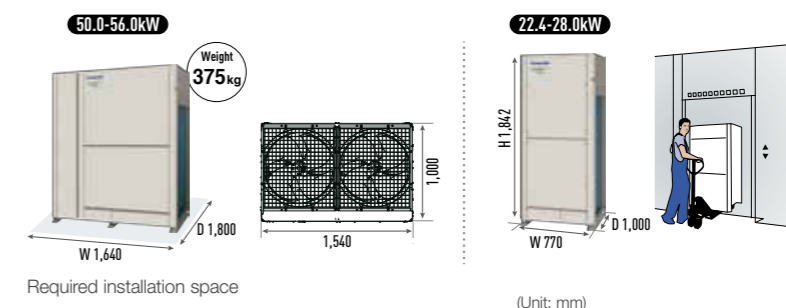

Newly designed fan

Optimised air flow

Newly designed fan and bell-mouth reduces stress on the fan by dispersing air quickly. Thus, lower air resistance results in lower energy consumption.

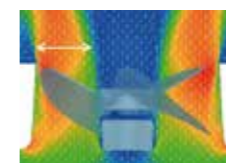

Noise reduction

Turbulence (blue) can be suppressed and the unwanted noise can be reduced. Even though a high speed fan is utilised, the noise level is still very low.



High-efficiency & Space-saving VRF system

2-PIPE FSV-EX ME2

High external static pressure on condensers

With a newly designed fan, fan guard, motor, and casing, new models can be custom-installed on-site to provide up to 80 Pa of external static pressure. An air discharge duct prevents shortages of air circulation, allowing outdoor units to be installed on every floor of a building.



Fan

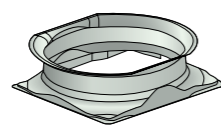

Fan Motor and Casing

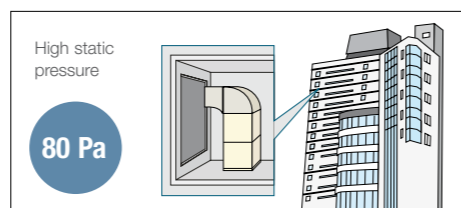

Extended compressor life by uniform compressor operation time

The total run-time of compressors are monitored by a built-in microcomputer, which ensures that operation times of all compressors within the same refrigerant circuit are balanced.

Compressors with histories showing shorter run times are selected first, ensuring equal wear and tear across all units and extended the working life of the system.

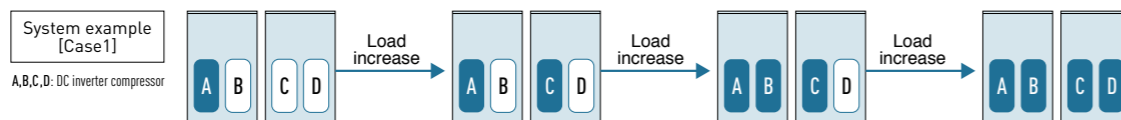

* Depend on accumulated operation time of each compressors.
 * Compressor priority has possibility to be changed.
 (e.g) Case1: A→C→B→D, Case2: C→A→D→B, Case3: A→C→D→B, Case4: C→A→B→D

Automatic backup operation in the case of compressor failure or outdoor unit malfunction

Except for 22.4, 28.0 & 33.5kW single unit installation

*Backup operation allows uninterrupted cooling or heating to continue whilst waiting for service.
 Users should contact their authorised service centre as soon as fault occurs.



Automatic backup operation.

Flexible demand response

Demand response

Featuring inverter control technology, ME2 series systems are Demand Response Management (DRM) ready. With this control, power consumption at times of peak load can be set in three steps to deliver optimum performance. This helps to correspond with the local power management for reducing peak power consumption, and to reduce annual power consumption with minimal loss in comfort.

Demand control setting level and unit behavior image

It is possible to limit the operating current of ME2 series system to 3 stages (75%/50%/0%) according to the demand control signal sent from the building.

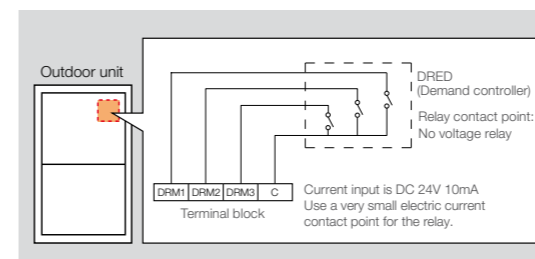
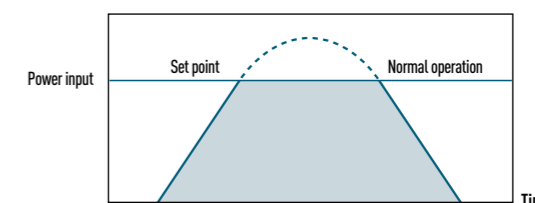

Terminal no. for demand section	Description
DRM3	Approx. 75% of rated current
DRM2	Approx. 50% of rated current
DRM1	Compressor off

High-durability outdoor unit

Corrosion-resistance treated for high resistance to rust and salty air to assure long-lasting performance.

Note: Selecting this unit does not completely eliminate the possibility of rust developing. For details concerning unit installation and maintenance, please consult an authorised dealer.

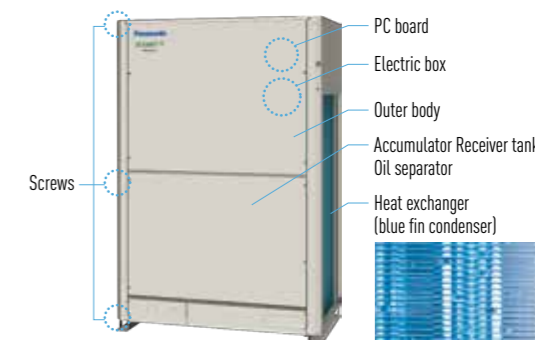

2-PIPE FSV-EX ME2 Series **SPACE SAVING COMBINATION MODEL**

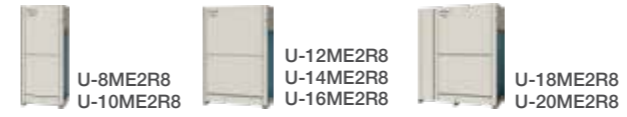

22.4 / 28.0kW

According to the installation site, you may choose the setting position in the depth direction of the anchor bolt from A, B or C.

- A: (Installation hole pitch) For removing pipe forward
- B: (Installation hole pitch) For removing the pipe downward
- C: (Installation hole pitch)

Top view

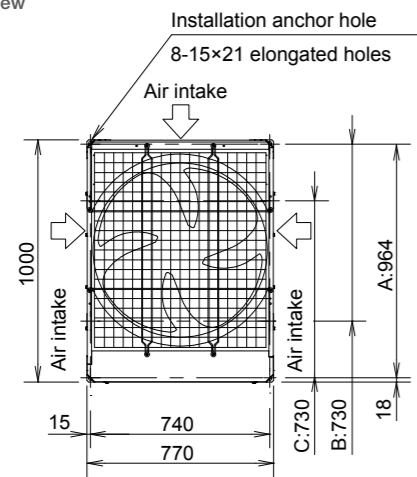

Front view

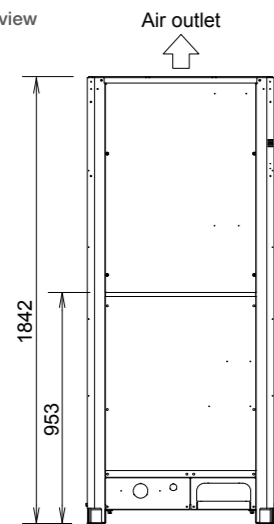

unit: mm

22.4 / 28.0 / 33.5 / 40.0 / 45.0kW

According to the installation site, you may choose the setting position in the depth direction of the anchor bolt from A, B or C.

- A: (Installation hole pitch) For removing pipe forward
- B: (Installation hole pitch) For removing the pipe downward
- C: (Installation hole pitch)

Top view

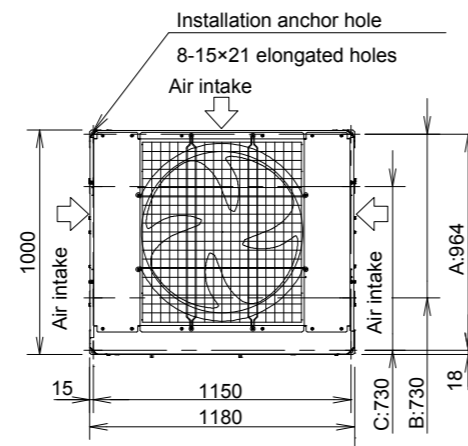

Front view

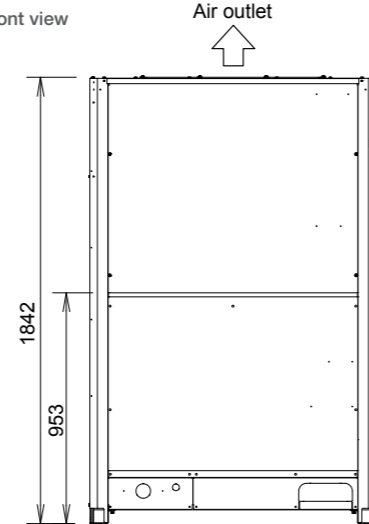

unit: mm

50.0 / 56.0kW

According to the installation site, you may choose the setting position in the depth direction of the anchor bolt from A, B or C.

- A: (Installation hole pitch) For removing pipe forward
- B: (Installation hole pitch) For removing the pipe downward
- C: (Installation hole pitch)

Top view

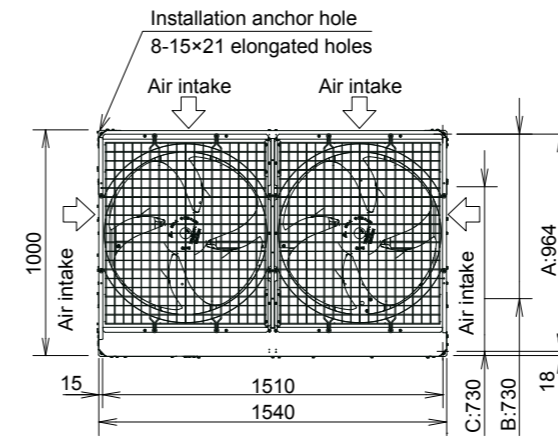

Front view

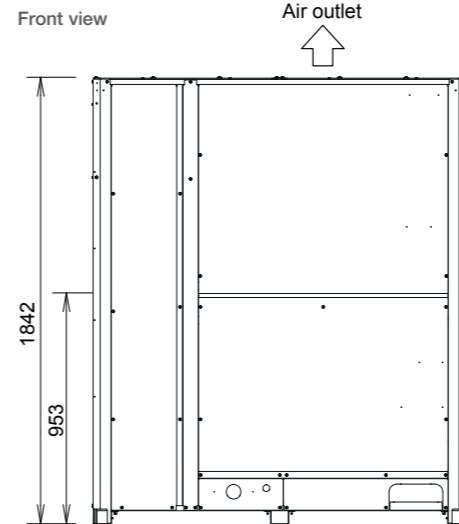

unit: mm

Piping Design

Select installation locations so that the lengths and sizes of refrigerant piping are within the allowable ranges shown in the figure below.

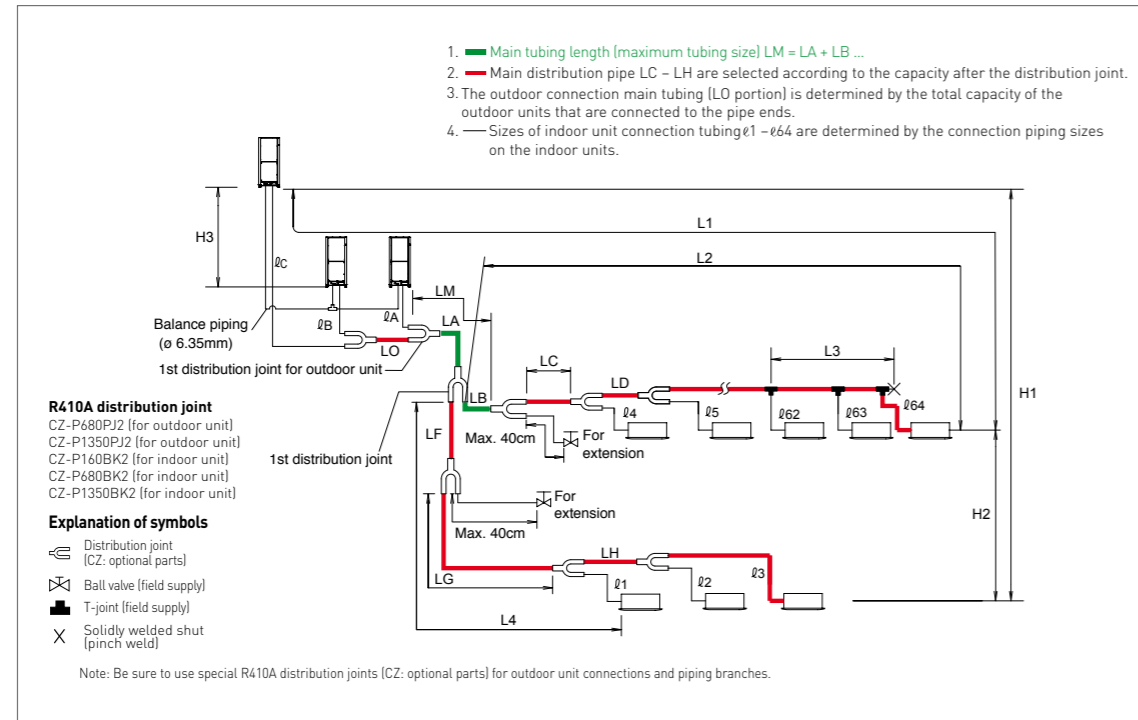

Ranges that apply to refrigerant piping lengths and to differences in installation heights

Items	Mark	Contents	Length (m)
Allowable piping length	L1	Max. piping length	Actual length $\leq 200^{*2}$ Equivalent length $\leq 210^{*2}$
	ΔL (L2-L4)	Difference between max. length and min. length from the 1st distribution joint	$\leq 50^{*5}$
	LM	Max. length of main piping (at maximum size) * Even after 1st distribution joint, LM is allowed if at maximum piping length.	— ^{*3}
	$\phi 1, \phi 2 - \phi 64$	Max. length of each distribution pipe	$\leq 30^{*7}$
	$L1 + \phi 1 + \phi 2 - \phi 63 + \phi A + \phi B + LF + LG + LH$	Total max. piping length including length of each distribution pipe (only liquid piping)	≤ 1000
Allowable elevation difference	$\phi A, \phi B + LO, \phi C + LO$	Maximum piping length from outdoor's 1st distribution joint to each outdoor unit	≤ 10
	H1	When outdoor unit is installed higher than indoor unit	≤ 50
	H2	When outdoor unit is installed lower than indoor unit	≤ 40
Allowable length of joint piping	H3	Max. difference between indoor units	$\leq 15^{*6}$
	L3	T-joint piping (field-supply); Max. piping length between the first T-joint and solidly welded-shut end point	≤ 2

L = Length, H = Height

NOTE

- The outdoor connection main piping (LO portion) is determined by the total capacity of the outdoor units that are connected to the pipe ends.
- If the longest piping length (L1) exceeds 90 m (equivalent length), increase the sizes of the main pipe (LM) by 1 rank for gas pipe and liquid pipe. Use a field supply reducer. Select the pipe size from the table of main piping sizes (Table 3) and from the table of refrigerant piping sizes (Table 8) on the second following page.
- If the longest main piping length (LM) exceeds 50 m, increase the main piping size at the portion before 50 m by 1 rank for the gas pipe. Use a field supply reducer. Determine the length less than the limitation of allowable maximum piping length. For the portion that exceeds 50 m, set based on the main piping size (LA) listed in Table 3.
- If the size of the existing piping is already larger than the standard piping size, it is not necessary to further increase the size.
* If the existing piping is used, and the amount of on-site refrigerant charge exceeds the value listed below, then change the size of the piping to reduce the amount of refrigerant.
Total amount of refrigerant for the system with 1 outdoor unit: 50 kg
Total amount of refrigerant for the system with 2 outdoor units: 80 kg
Total amount of refrigerant for the system with 3 outdoor units or 4 outdoor units: 105 kg
- When the piping length exceeds 40 m, increase a longer liquid or gas piping by 1 rank. Refer to the Technical Data for the details.
- If the total distribution piping length exceeds 500m, maximum allowable elevation difference (H2) between the indoor units is calculated by the following formula. Make sure the indoor unit's actual elevation difference should fall within the figure calculated as follows.
Unit of account (meter): $15 \times (2 - \text{total piping length(m)} \div 500)$
- If any of the piping length exceeds 30m, increase the size of the liquid and gas pipe by 1 rank.

Necessary amount of additional refrigerant charge per outdoor unit

U-8ME2R8	U-10ME2R8	U-12ME2R8	U-14ME2R8	U-16ME2R8	U-18ME2R8	U-20ME2R8
0 kg	0 kg	4.0 kg	4.0 kg	4.0 kg	5.5 kg	5.5 kg

System limitations

Max. No. allowable connected outdoor units	4 ^{*2}
Max. capacity allowable connected outdoor units	224kW (80HP)
Max. connectable indoor units	64 ^{*1}
Max. allowable indoor/outdoor capacity ratio	50-130 % ^{*3}

- *1: In the case of 107.0kW or smaller units, the number is limited by the total capacity of the connected indoor units.
 *2: Up to 4 units can be connected if the system has been extended.
 *3: If the following conditions are satisfied, the effective range is above 130 % and below 200 %.
 i) Obey the limited number of connectable indoor units.
 ii) The lower limit of operating range for heating outdoor temperature is limited to -10°CWB (standard -25°CWB).
 iii) Simultaneous operation is limited to less than 130 % of connectable indoor units.

Additional refrigerant charge

Liquid piping size mm (inches)	Amount of refrigerant charge/m (g/m)
$\phi 6.35$ ($\phi 1/4$)	26
$\phi 9.52$ ($\phi 3/8$)	56
$\phi 12.7$ ($\phi 1/2$)	128
$\phi 15.88$ ($\phi 5/8$)	185
$\phi 19.05$ ($\phi 3/4$)	259
$\phi 22.22$ ($\phi 7/8$)	366
$\phi 25.4$ ($\phi 1$)	490

Refrigerant piping (Existing piping can be used.)

High Efficiency Combination Model

Piping size (mm)			
Material Temper - O		Material Temper - 1/2 H, H	
$\phi 6.35$	t 0.8	$\phi 22.22$	t 1.0
$\phi 9.52$	t 0.8	$\phi 25.4$	t 1.0
$\phi 12.7$	t 0.8	$\phi 28.58$	t 1.0
$\phi 15.88$	t 1.0	$\phi 31.75$	t 1.1
$\phi 19.05$	t 1.2	$\phi 38.1$	over t 1.35
		$\phi 41.28$	over t 1.45
		$\phi 44.45$	over t1.55

Space Saving Combination Model

Piping size (mm)			
Material Temper - O		Material Temper - 1/2 H, H	
$\phi 6.35$	t 0.8	$\phi 22.22$	t 1.0
$\phi 9.52$	t 0.8	$\phi 25.4$	t 1.0
$\phi 12.7$	t 0.8	$\phi 28.58$	t 1.0
$\phi 15.88$	t 1.0	$\phi 31.75$	t 1.1
$\phi 19.05$	t 1.2	$\phi 38.1$	over t 1.35
		$\phi 41.28$	over t 1.45
		$\phi 44.45$	over t1.55
		$\phi 50.8$	over t1.8

* When bending the pipes, use a bending radius that is at least 4 times the outer diameter of the pipes. In addition, take sufficient care to avoid crushing or damaging the pipes when bending them.



Refrigerant Branch Pipes (optional accessories) for 2-PIPE ME2 Series

Optional Distribution Joint Kits

See the installation instructions packaged with the distribution joint kit for the installation procedure.

Model name	Cooling capacity after distribution	Remarks
1. CZ-P680PJ2	68.0 kW or less	For outdoor unit
2. CZ-P1350PJ2	168.0kW or less	For outdoor unit
3. CZ-P160BK2	22.4 kW or less	For indoor unit
4. CZ-P680BK2	68.0 kW or less	For indoor unit
5. CZ-P1350BK2	1680.0kW or less	For indoor unit

Piping size (with thermal insulation)

1. CZ-P680PJ2

Use: For outdoor unit
(Capacity after distribution joint is 68.0kW or less.)

GAS PIPING

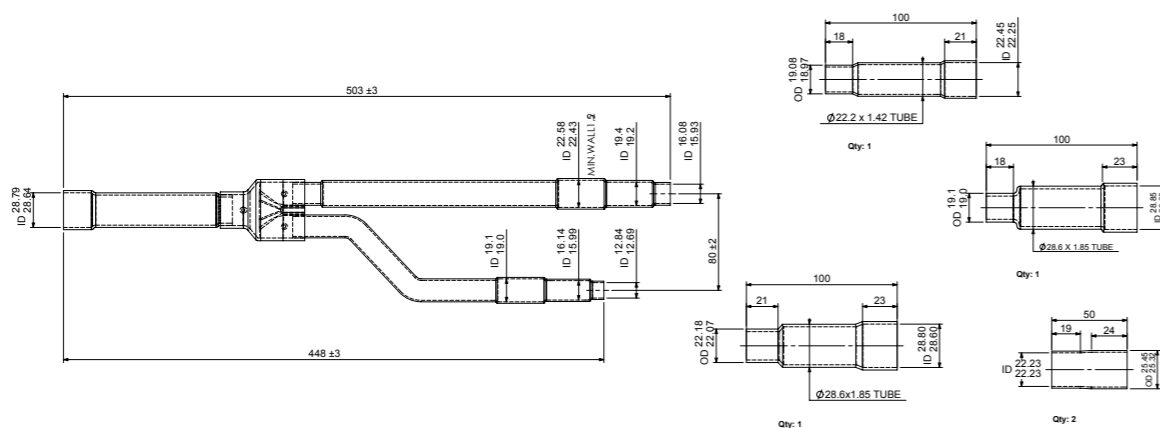

LIQUID PIPING

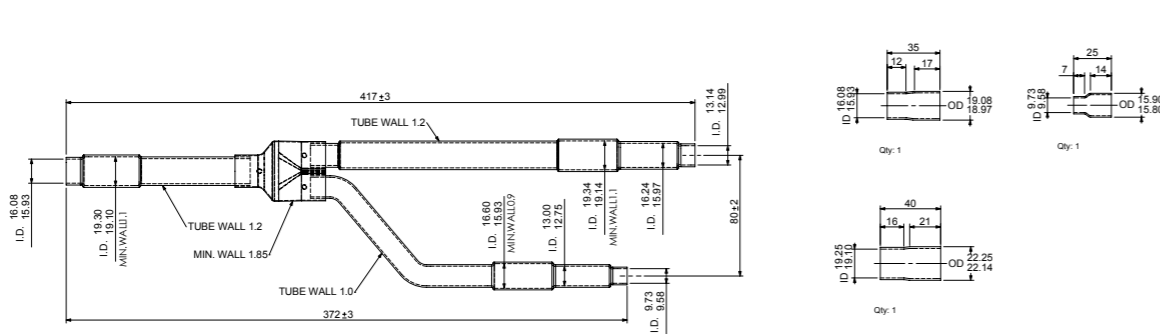

All measurements are in mm. Size of connection points on each part shown are inside diameters of piping.

2. CZ-P1350PJ2

Use: For outdoor unit (Capacity after distribution joint is greater than 68.0kW and no more than 168.0kW.)

GAS PIPING

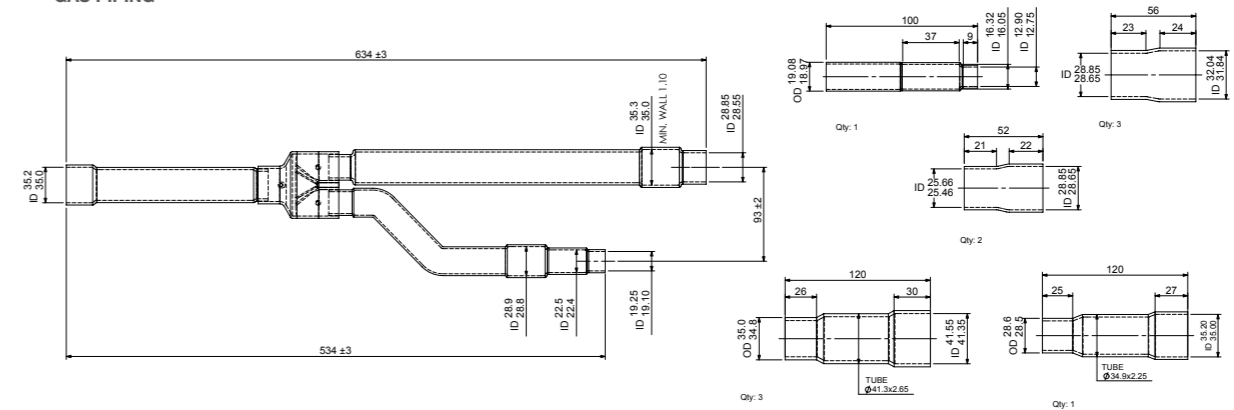

LIQUID PIPING

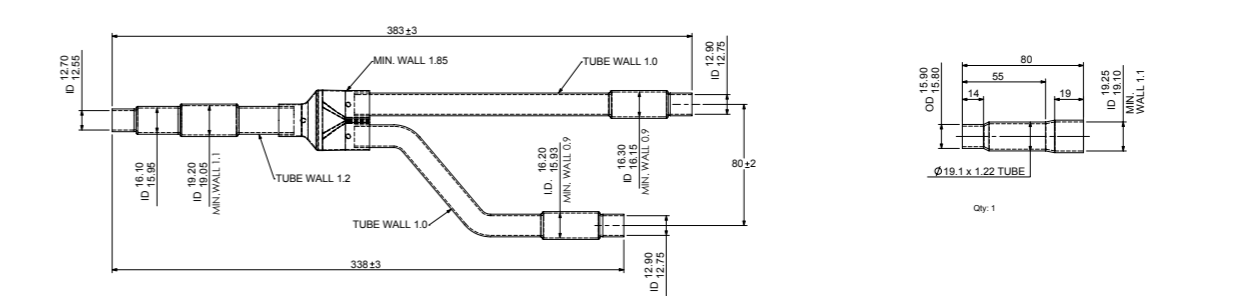

All measurements are in mm. Size of connection points on each part shown are inside diameters of piping.

3. CZ-P160BK2

Use: For indoor unit (Capacity after distribution joint is 22.4 kW or less.)

GAS PIPING

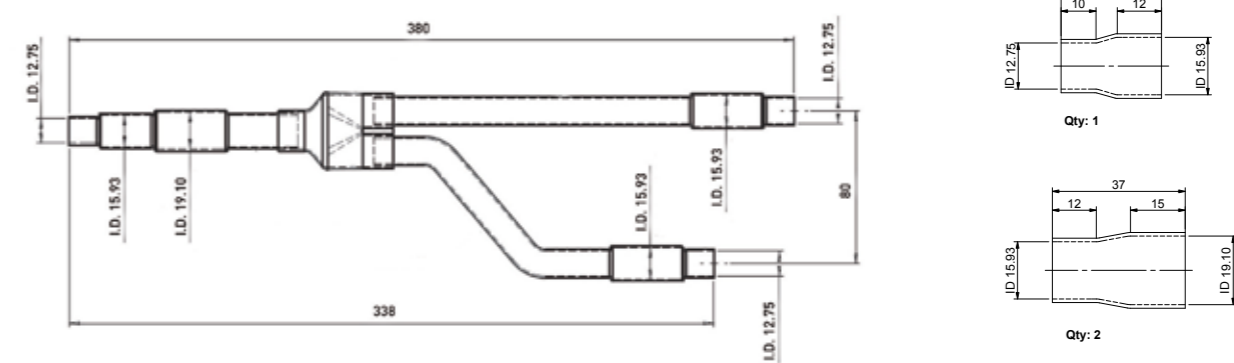

LIQUID PIPING

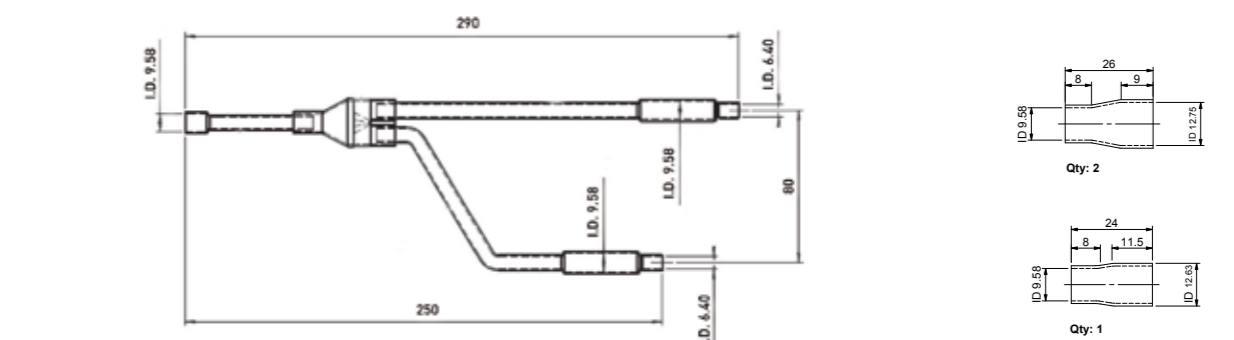

All measurements are in mm. Size of connection points on each part shown are inside diameters of piping.

Refrigerant Branch Pipes (optional accessories) for 2-PIPE ME2 Series

Piping size (with thermal insulation)

4. CZ-P680BK2

Use: For indoor unit (Capacity after distribution joint is more than 22.4 kW and no more than 68.0 kW).

GAS PIPING

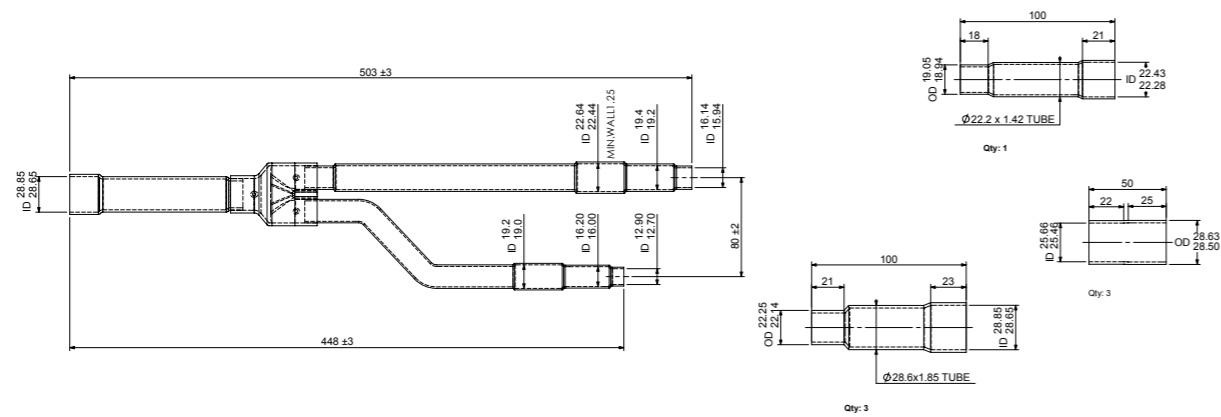

LIQUID PIPING

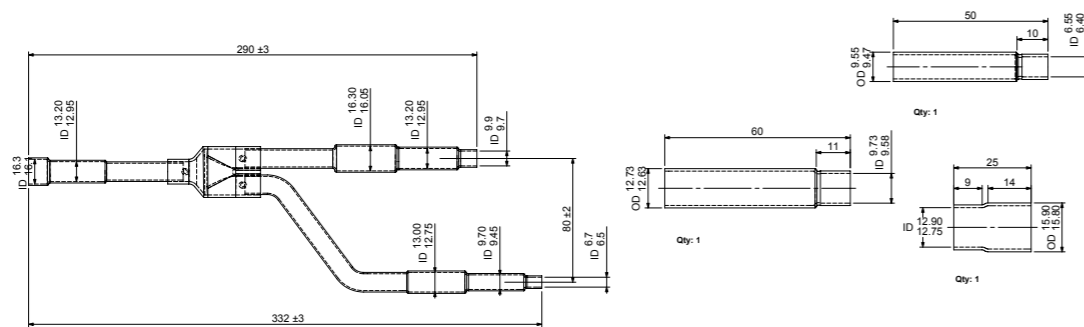

All measurements are in mm. Size of connection points on each part shown are inside diameters of piping.

5. CZ-P1350BK2

Use: For indoor unit (Capacity after distribution joint is greater than 68.0kW and no more than 168.0kW).

GAS PIPING

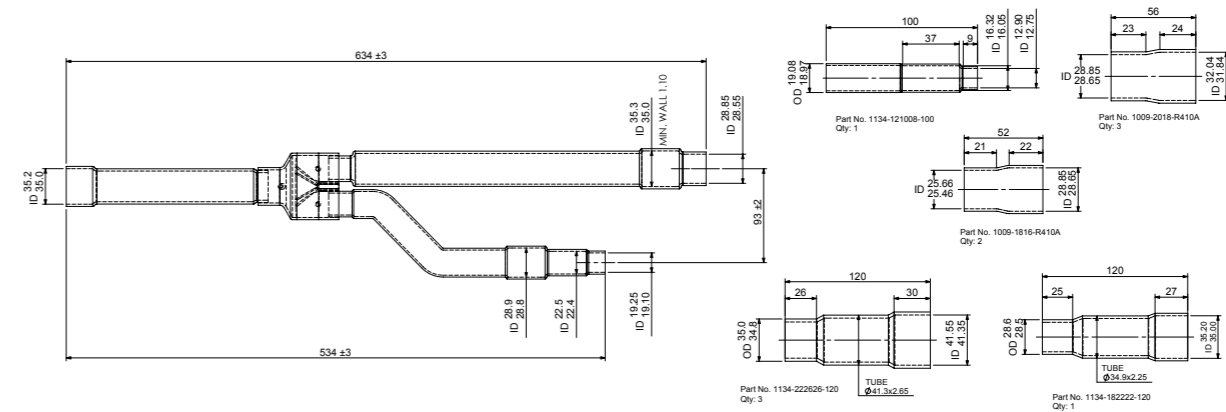

LIQUID PIPING

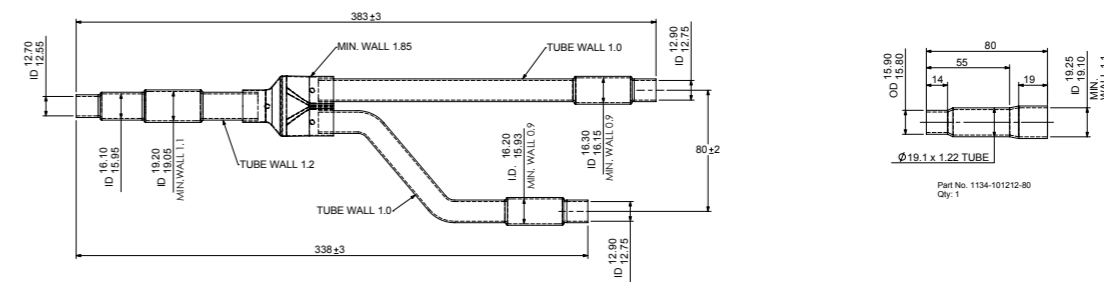

All measurements are in mm. Size of connection points on each part shown are inside diameters of piping.





Simultaneous heating and cooling VRF system

3-PIPE FSV-EX MF3 Series

Heat Recovery Type



New 3-PIPE FSV-EX MF3 series enables simultaneous heating and cooling operation

- Suitable for R22 renewal projects (Refer to Page 138)
- Demand response ready (Peak cut)



* Office building with diverse room temperatures due to the different amount of sunshine received.
 * The building with computer/business equipment rooms requiring year-round cooling.

Fully-automatic simultaneous cooling/heating operation and heat recovery

3-PIPE MF3 series enables simultaneous heating and cooling operation by each solenoid valve kit. New design to decrease chattering noise at low capacity load.

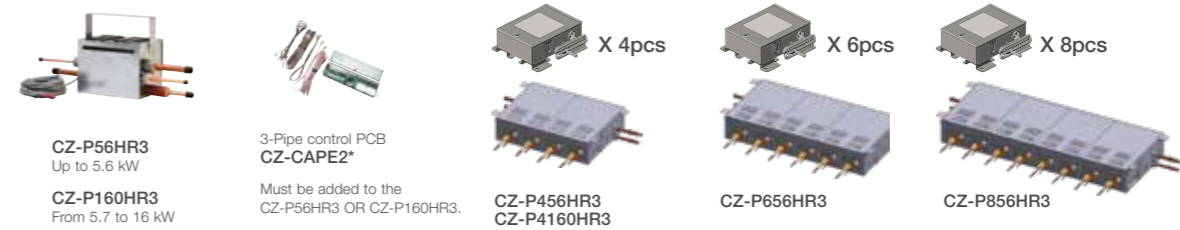

Individual control of multiple indoor units with solenoid valve kits

- Any design and layout can be used in a single system.
- Cooling operation is possible up to an outdoor temperature of -10°C DB.

System Structure

- Low temperature, Low pressure Gas
- Medium temperature, Medium pressure Liquid
- High temperature, High pressure Gas

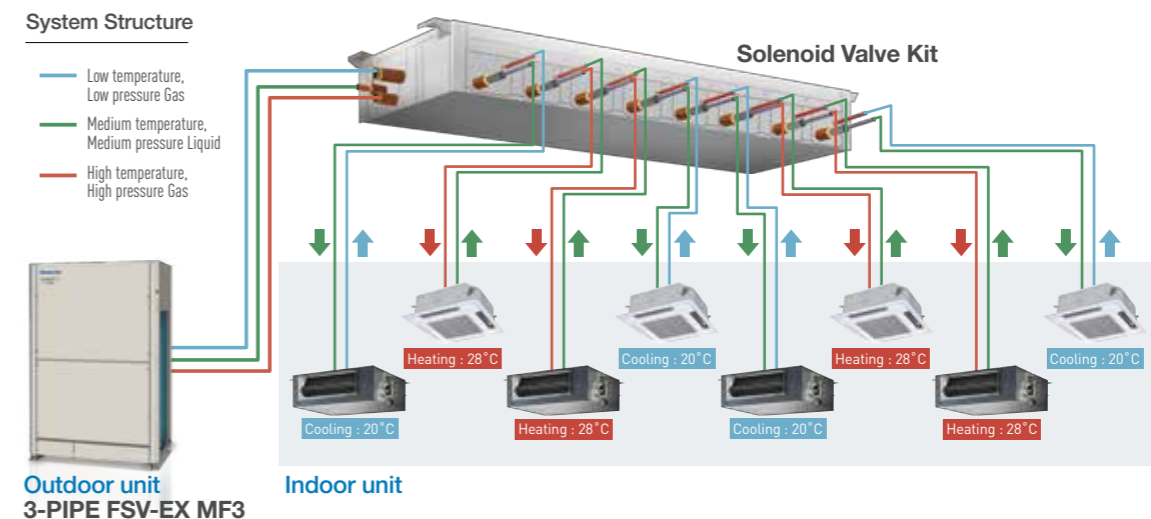

Simultaneous heating and cooling VRF system 3-PIPE FSV-EX MF3 Series

New Solenoid Valve Kit Multiple Connection Port Type

The new Panasonic Solenoid Valve Kit field installation work becomes more easy. In fact, our latest technology is designed new packages body without additional branch-kits and 3-PIPE control PCB. Connection pipe for main refrigerant circuit line comes on both side of the unit. It helps the system design and piping layout for more flexible.

System Structure

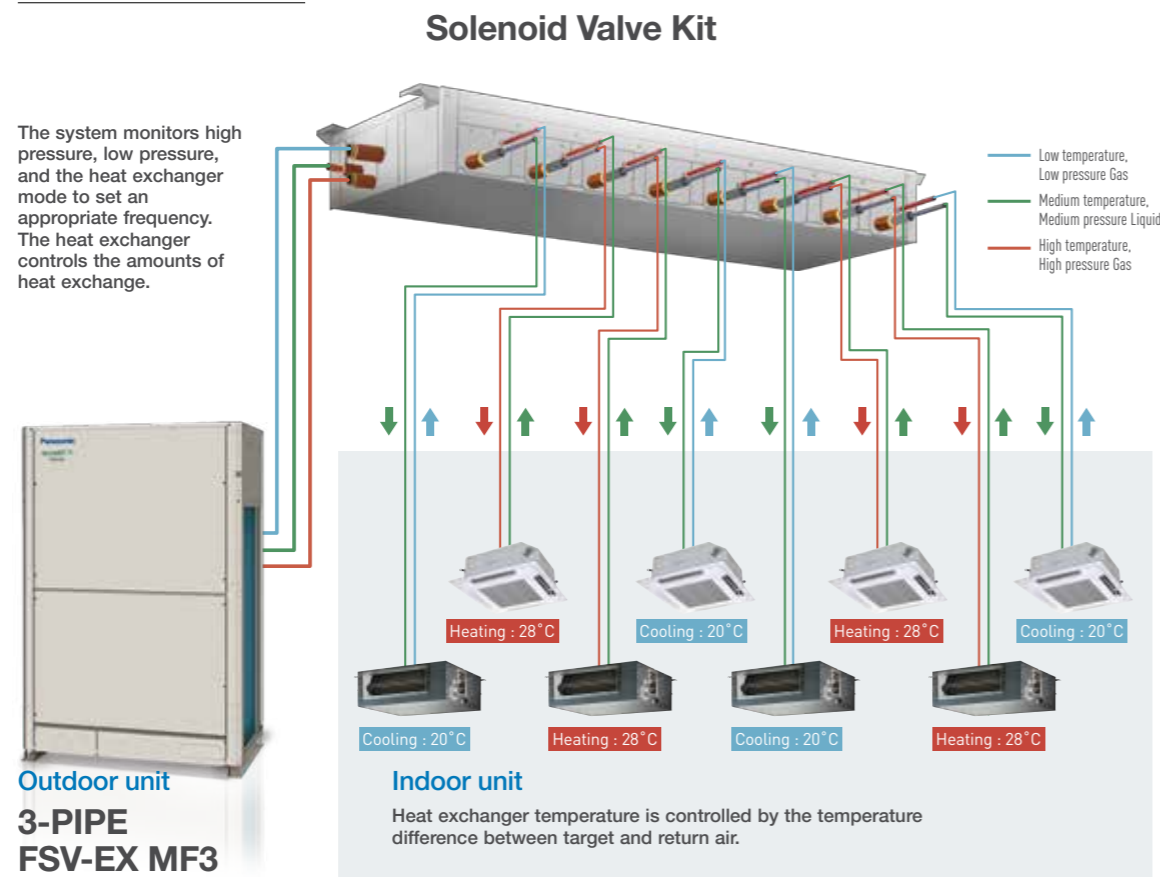

CZ-P456HR3
CZ-P4160HR3

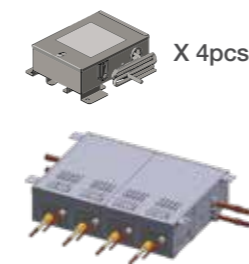

CZ-P656HR3

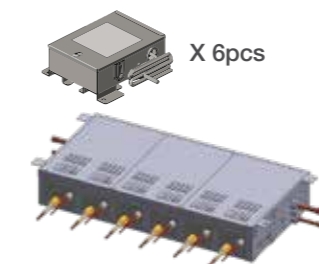

CZ-P856HR3

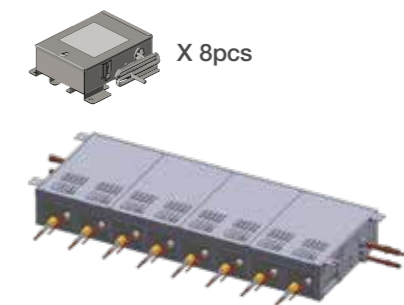

	1 port	4 port	6 port	8 port
56 type	CZ-P56HR3	CZ-P456HR3	CZ-P656HR3	CZ-P856HR3
160 type	CZ-P160HR3	CZ-P4160HR3	--	--

Solenoid Valve Kit / Wiring Work

Current Model / Single Connection Type

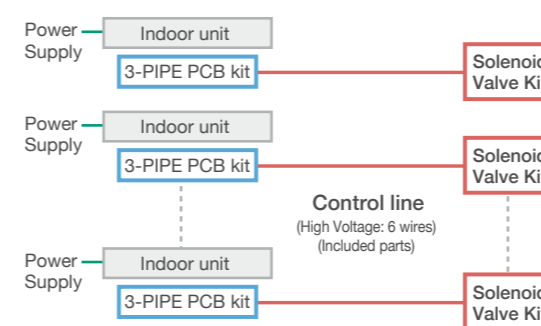

New Model / Multiple Connection Type

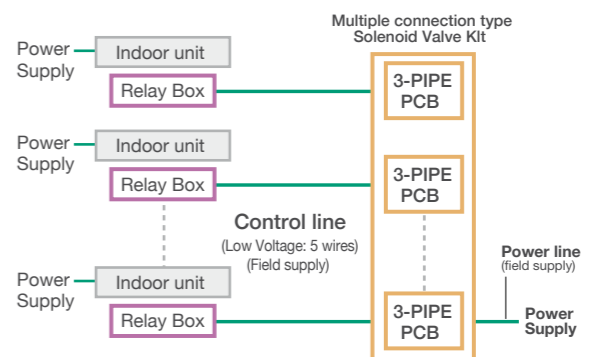

Simultaneous heating and cooling VRF system 3-PIPE FSV-EX MF3 Series

Increased max. number of connectable indoor units

The 3-PIPE MF3 series has four DC inverter outdoor units from 22.4kW to 45.0kW as the basic models, and by combination of up to three units, an air-conditioning capacity of 22.4kW to 135.0kW can be set according to the user needs.

System (kW)	22.4	28.0	33.5	40.0	45.0	50.0	56.0	61.5	68.0	73.0	78.5	85.0	90.0	96.0	101.0	107.0	113.0	118.0	124.0	130.0	135.0
Outdoor units	22.4	28.0	33.5	40.0	45.0	22.4	22.4	28.0	33.5	28.0	33.5	40.0	45.0	28.0	33.5	33.5	45.0	45.0	45.0	45.0	45.0
Connectable indoor units	15	19	22	27	30	34	38	41	46	49	52	52	52	52	52	52	52	52	52	52	52

Connectable indoor/outdoor unit capacity ratio up to 150%

Long piping design

Adaptable to various building types and sizes
Actual piping length : 200m
Max piping length : 500m

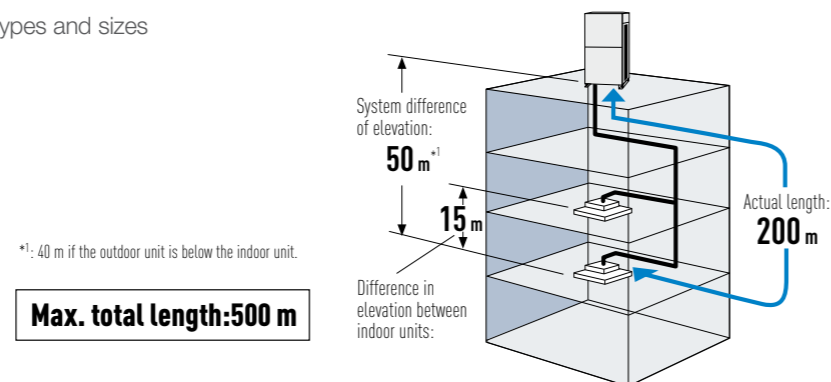

Up to 40m piping after first branch

Up to 52 units can be connected to one system. Flexible piping layout makes it easier to design systems for locations such as train stations, airports, schools and hospitals.

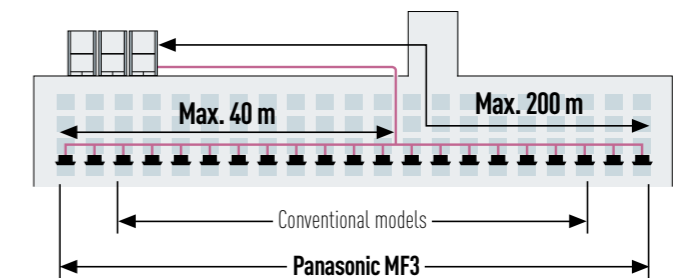

Extended operating range

Cooling operation range:

The cooling operation range has been extended to -10°C DB to +52°C DB by changing the outdoor fan to an inverter type.

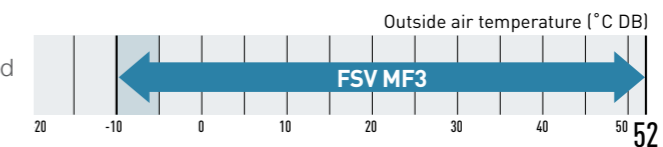

Heating operation range:

Stable heating operation even with an outside air temperature of -20°C WB

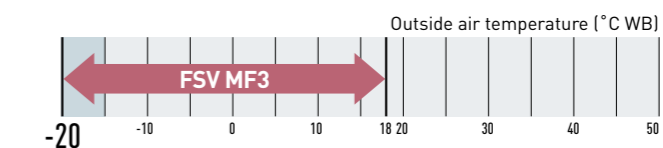

Wide temperature setting range

Wired remote control heating temperature setting range is 16 to 30°C

Remark: Cooling/heating capacity depend on indoor/outdoor temperature. Please refer technical databook.

Excellent energy saving

The operation efficiency has been improved using highly efficient R410A refrigerant, new DC inverter compressor, and new heat exchanger design.

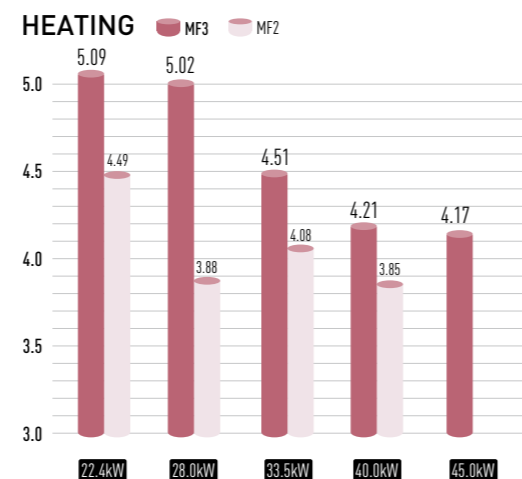
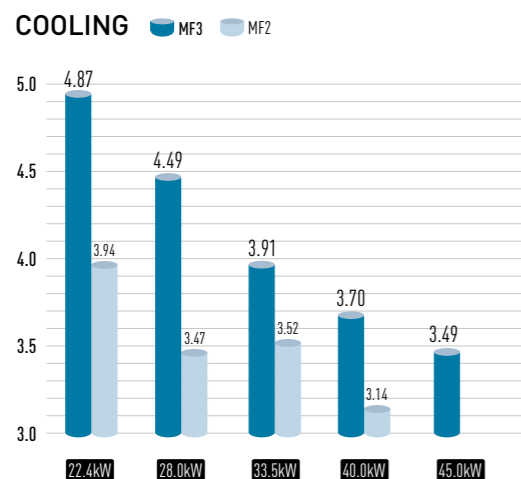

Newly designed fan

Optimised air flow

Newly designed fan and bell-mouth reduces stress on the fan by dispersing air quickly. Thus, lower air resistance results in lower energy consumption.

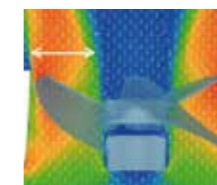

Noise reduction

Turbulence (blue) can be suppressed and the unwanted noise can be reduced. Even though a high speed fan is utilised, the noise level is still very low.

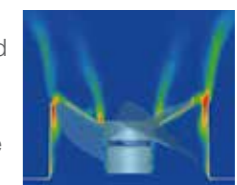

Simultaneous heating and cooling VRF system 3-PIPE FSV-EX MF3 Series

High external static pressure on condensers

With a newly designed fan, fan guard, motor, and casing, new models can be custom-installed on-site to provide up to 80 Pa of external static pressure. An air discharge duct prevents shortages of air circulation, allowing outdoor units to be installed on every floor of a building.



Fan

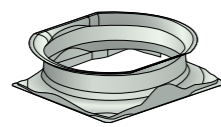

Fan Motor and Casing

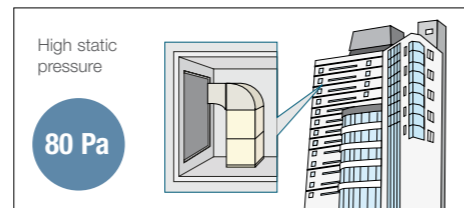

Extended compressor life by uniform compressor operation time

The total run-time of compressors are monitored by a built-in microcomputer, which ensures that operation times of all compressors within the same refrigerant circuit are balanced.

Compressors with histories showing shorter run times are selected first, ensuring equal wear and tear across all units and extended the working life of the system.

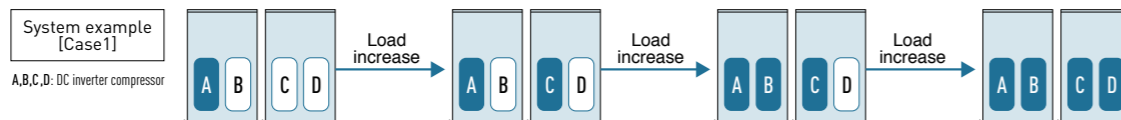

* Depend on accumulated operation time of each compressors.
* Compressor priority has possibility to be changed.
(e.g) Case1: A→C→B→D, Case2: C→A→D→B, Case3: A→C→D→B, Case4: C→A→B→D

Automatic backup operation in the case of compressor failure or outdoor unit malfunction

Except for 22.4, 28.0 & 33.5kW single unit installation

*Backup operation allows uninterrupted cooling or heating to continue whilst waiting for service. Users should contact their authorised service centre as soon as fault occurs.

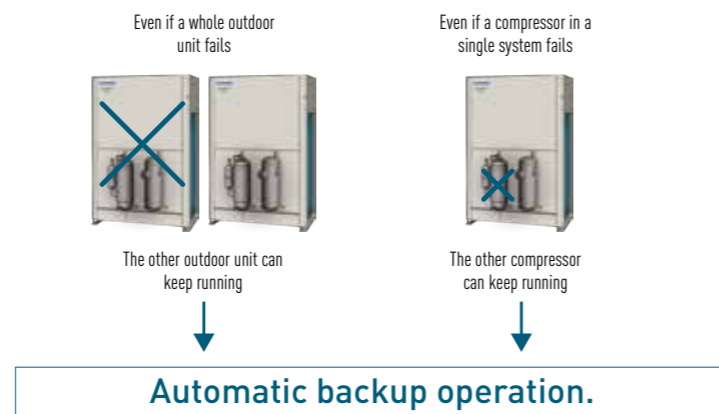

Flexible demand response

Demand response

Featuring inverter control technology, MF3 series systems are Demand Response Management (DRM) ready. With this control, power consumption at times of peak load can be set in three steps to deliver optimum performance. This helps to correspond with the local power management for reducing peak power consumption, and to reduce annual power consumption with minimal loss in comfort.

Demand control setting level and unit behavior image

It is possible to limit the operating current of MF3 series system to 3 stages (75%/50%/0%) according to the demand control signal sent from the building.

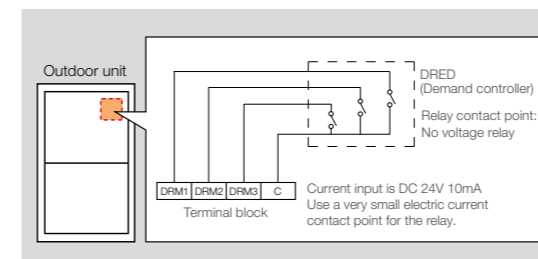
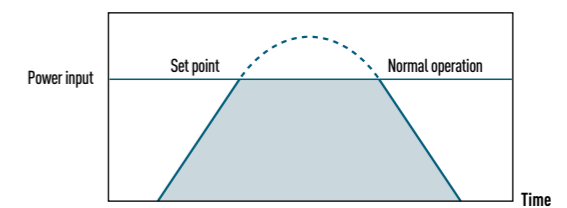

Terminal no. for demand section	Description
DRM3	Approx. 75% of rated current
DRM2	Approx. 50% of rated current
DRM1	Compressor off

Blue fin condenser outdoor unit

The anti-corrosion Blue Fin treatment of the heat exchanger provides greater resistance against corrosion. All models are equipped with Blue Fin condenser.

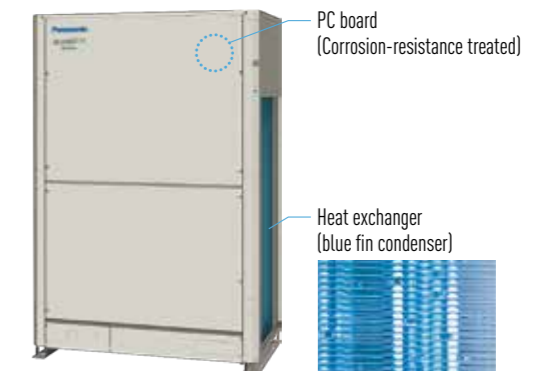

3-PIPE FSV-EX MF3 Series

Appearance													
kW	22.4	28.0	33.5	40.0	45.0	50.0	56.0	61.5	68.0	73.0			
Model name	U-8MF3R7	U-10MF3R7	U-12MF3R7	U-14MF3R7	U-16MF3R7	U-8MF3R7 U-10MF3R7	U-8MF3R7 U-12MF3R7	U-10MF3R7 U-12MF3R7	U-12MF3R7 U-12MF3R7	U-10MF3R7 U-16MF3R7	U-10MF3R7 U-16MF3R7		
Power supply	380/400/415V, 3 phase - 50Hz 380/400V, 3 phase - 60Hz												
Capacity	Cooling	kW	22.4	28.0	33.5	40.0	45.0	50.0	56.0	61.5	68.0	73.0	
		BTU/h	76,500	95,600	114,300	136,500	153,600	170,600	191,100	209,900	232,100	249,100	
EER / COP	Cooling	W/W	4.87	4.49	3.91	3.70	3.49	4.67	4.24	4.16	3.89	3.82	
	Heating	W/W	5.09	5.02	4.51	4.21	4.17	5.09	4.70	4.73	4.47	4.45	
Dimensions	H x W x D	mm	1,842x1,180 x1,000	1,842x1,180 x1,000	1,842x1,180 x1,000	1,842x1,180 x1,000	1,842x1,180 x1,000	1,842x2,420 x1,000	1,842x2,420 x1,000	1,842x2,420 x1,000	1,842x2,420 x1,000		
Net weight		kg	264	265	289	337	337	529	553	554	578	602	
Electrical ratings	Cooling	Running current	A	7.52	10.4	13.9	18.2	21.3	17.7	21.3	24.2	28.3	31.5
		Power input	kW	4.60	6.23	8.57	10.8	12.9	10.7	13.2	14.8	17.5	19.1
	Heating	Running current	A	8.02	10.5	13.4	18.1	20.0	18.2	21.7	23.9	27.6	30.6
		Power input	kW	4.91	6.27	8.32	10.7	12.0	11.0	13.4	14.6	17.1	18.3
Air flow rate		m³/h	12,600	13,200	13,920	13,920	13,920	25,800	26,520	27,120	27,840	27,120	
		L/s	3,500	3,667	3,867	3,867	3,867	7,166	7,366	7,533	7,733	7,533	
Refrigerant amount at shipment		kg	9.8	9.8	11.8	11.8	11.8	19.6	21.6	21.6	23.6	21.6	
Piping connections	Suction pipe	mm (inches)	Ø19.05 (Ø3/4)	Ø22.22 (Ø7/8)	Ø25.40 (Ø1)	Ø25.40 (Ø1)	Ø28.58 (Ø1-1/8)	Ø28.58 (Ø1-1/8)	Ø28.58 (Ø1-1/8)	Ø28.58 (Ø1-1/8)	Ø28.58 (Ø1-1/8)	Ø31.75 (Ø1-1/4)	
	Discharge pipe	mm (inches)	Ø15.88 (Ø5/8)	Ø19.05 (Ø3/4)	Ø19.05 (Ø3/4)	Ø22.22 (Ø7/8)	Ø22.22 (Ø7/8)	Ø22.22 (Ø7/8)	Ø22.22 (Ø7/8)	Ø25.40 (Ø1)	Ø25.40 (Ø1)	Ø25.40 (Ø1)	
	Liquid pipe	mm (inches)	Ø9.52 (Ø3/8)	Ø9.52 (Ø3/8)	Ø12.70 (Ø1/2)	Ø12.70 (Ø1/2)	Ø12.70 (Ø1/2)	Ø15.88 (Ø5/8)	Ø15.88 (Ø5/8)	Ø15.88 (Ø5/8)	Ø15.88 (Ø5/8)	Ø19.05 (Ø3/4)	
	Balance pipe	mm (inches)	Ø6.35 (Ø1/4)	Ø6.35 (Ø1/4)	Ø6.35 (Ø1/4)	Ø6.35 (Ø1/4)	Ø6.35 (Ø1/4)	Ø6.35 (Ø1/4)	Ø6.35 (Ø1/4)	Ø6.35 (Ø1/4)	Ø6.35 (Ø1/4)	Ø6.35 (Ø1/4)	
Ambient temperature operating range			Cooling/Dry: -10°C~+52°C (DB). Heating: -20°C~+18°C (WB) Simultaneous operation: -10°C~+24°C (DB)										
Sound pressure level	Normal mode	dB (A)	54.0	57.0	60.0	61.0	62.0	59.0	61.0	62.0	63.0	63.5	
	Silent mode	dB (A)	49.0	52.0	55.0	56.0	57.0	54.0	56.0	57.0	58.0	58.5	

Appearance														
kW	78.5	85.0	90.0	96.0	101.0	107.0	113.0	118.0	124.0	130.0	135.0			
Model name	U-12MF3R8 U-16MF3R8	U-14MF3R7 U-16MF3R7	U-16MF3R7 U-16MF3R7	U-8MF3R7 U-10MF2R7 U-16MF3R7	U-8MF3R7 U-12MF3R7 U-16MF3R7	U-10MF3R7 U-12MF3R7 U-16MF3R7	U-8MF3R7 U-16MF3R7 U-16MF3R7	U-10MF3R7 U-16MF3R7 U-16MF3R7	U-12MF3R7 U-16MF3R7 U-16MF3R7	U-14MF3R7 U-16MF3R7 U-16MF3R7	U-16MF3R7 U-16MF3R7 U-16MF3R7			
Power supply	380/400/415V, 3 phase - 50Hz 380/400V, 3 phase - 60Hz													
Capacity	Cooling	kW	78.5	85.0	90.0	96.0	101.0	107.0	113.0	118.0	124.0	130.0	135.0	
		BTU/h	267,900	290,100	307,200	327,600	344,700	365,200	385,700	402,700	423,200	443,700	460,800	
EER / COP	Cooling	W/W	87.5	95.0	100.0	108.0	113.0	119.0	127.0	132.0	138.0	145.0	150.0	
	Heating	W/W	3.65	3.59	3.49	4.00	3.87	3.84	3.69	3.69	3.58	3.55	3.49	
Dimensions	H x W x D	mm	1,842x2,420 x1,000	1,842x2,420 x1,000	1,842x2,420 x1,000	1,842x3,660 x1,000	1,842x3,660 x1,000	1,842x3,660 x1,000	1,842x3,660 x1,000	1,842x3,660 x1,000	1,842x3,660 x1,000	1,842x3,660 x1,000	1,842x3,660 x1,000	
	Net weight		kg	626	674	674	866	890	891	938	939	963	1,011	1,011
Electrical ratings	Cooling	Running current	A	35.1	39.6	42.6	39.6	42.6	46.1	50.5	52.8	56.5	61.1	63.9
		Power input	kW	21.5	23.7	25.8	24.0	26.1	27.9	30.6	32.0	34.6	36.6	38.7
	Heating	Running current	A	33.5	37.9	40.1	39.6	41.9	43.9	49.4	50.8	53.7	57.9	60.1
		Power input	kW	20.3	22.7	24.0	23.7	25.4	26.6	29.6	30.4	32.5	34.7	36.0
Air flow rate		m³/h	27,840	27,840	27,840	39,720	40,440	41,040	40,440	41,040	41,760	41,760	41,760	
		L/s	7,733	7,733	7,733	11,033	11,233	11,400	11,233	11,400	11,600	11,600	11,600	
Refrigerant amount at shipment		kg	23.6	23.6	23.6	31.4	33.4	33.4	33.4	33.4	35.4	35.4	35.4	
Piping connections	Suction pipe	mm (inches)	Ø31.75 (Ø1-1/4)	Ø31.75 (Ø1-1/4)	Ø31.75 (Ø1-1/4)	Ø31.75 (Ø1-1/4)	Ø38.1 (Ø1-1/2)	Ø38.1 (Ø1-1/2)	Ø38.1 (Ø1-1/2)	Ø38.1 (Ø1-1/2)	Ø38.1 (Ø1-1/2)	Ø38.1 (Ø1-1/2)	Ø38.1 (Ø1-1/2)	
	Discharge pipe	mm (inches)	Ø28.58 (Ø1-1/8)	Ø28.58 (Ø1-1/8)	Ø28.58 (Ø1-1/8)	Ø28.58 (Ø1-1/8)	Ø28.58 (Ø1-1/8)	Ø28.58 (Ø1-1/8)	Ø31.75 (Ø1-1/4)	Ø31.75 (Ø1-1/4)	Ø31.75 (Ø1-1/4)	Ø31.75 (Ø1-1/4)	Ø31.75 (Ø1-1/4)	
	Liquid pipe	mm (inches)	Ø19.05 (Ø3/4)	Ø19.05 (Ø3/4)	Ø19.05 (Ø3/4)	Ø19.05 (Ø3/4)	Ø19.05 (Ø3/4)	Ø19.05 (Ø3/4)	Ø19.05 (Ø3/4)	Ø19.05 (Ø3/4)	Ø19.05 (Ø3/4)	Ø19.05 (Ø3/4)	Ø19.05 (Ø3/4)	
	Balance pipe	mm (inches)	Ø6.35 (Ø1/4)	Ø6.35 (Ø1/4)	Ø6.35 (Ø1/4)	Ø6.35 (Ø1/4)	Ø6.35 (Ø1/4)	Ø6.35 (Ø1/4)	Ø6.35 (Ø1/4)	Ø6.35 (Ø1/4)	Ø6.35 (Ø1/4)	Ø6.35 (Ø1/4)	Ø6.35 (Ø1/4)	
Ambient temperature operating range			Cooling/Dry: -10°C~+52°C (DB). Heating: -20°C~+18°C (WB) Simultaneous operation: -10°C~+24°C (DB)											
Sound pressure level	Normal mode	dB (A)	64.5	64.5	65.0	64.0	64.5	65.0	65.5	66.0	66.5	66.5	67.0	
	Silent mode	dB (A)	59.5	59.5	60.0	59.0	59.5	60.0	60.5	61.0	61.5	61.5	62.0	

These specifications are subject to change without notice.
 * For mixed heating and cooling operation with an outdoor temperature in excess of 24°C DB, please use 50% or more of the horsepower of the outdoor unit for cooling operation.

System example

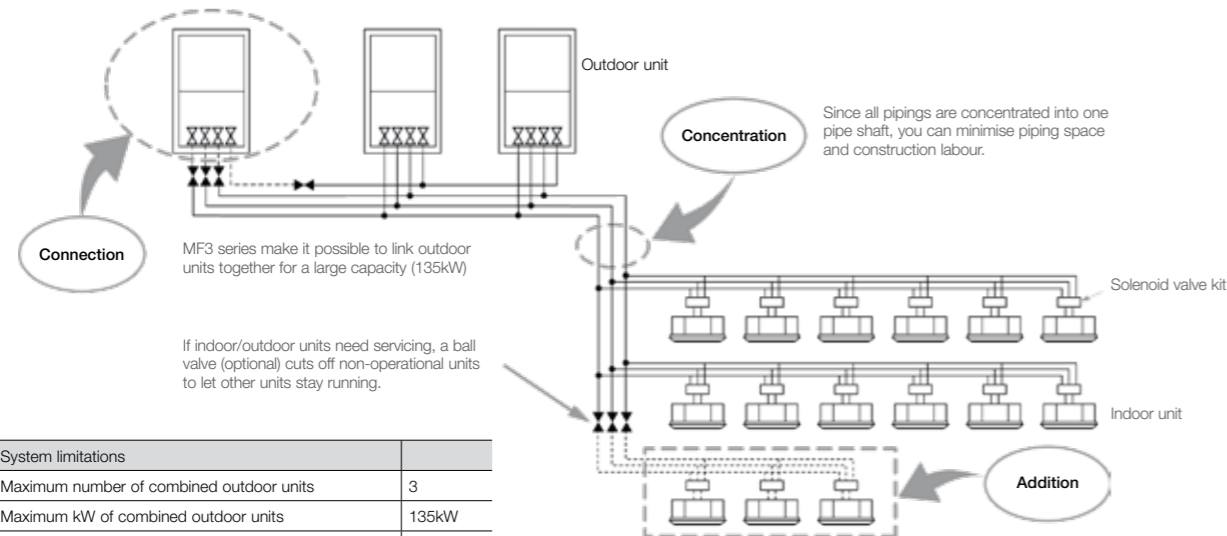

System limitations	
Maximum number of combined outdoor units	3
Maximum kW of combined outdoor units	135kW
Maximum number of connectable indoor units	52
Indoor/outdoor unit capacity ratio	50-150%
Maximum actual piping length	200 m
Maximum level difference (when outdoor unit is lower)	50 (40) m
Maximum total piping length in one direction	500 m

If your indoor capacity load changes in the future, it's easy to add on both indoor and outdoor units using the same pipings.

If the additional installment of outdoor and indoor units is expected, the size of refrigerant piping should be decided according to the total capacity after the addition.

Dimensions

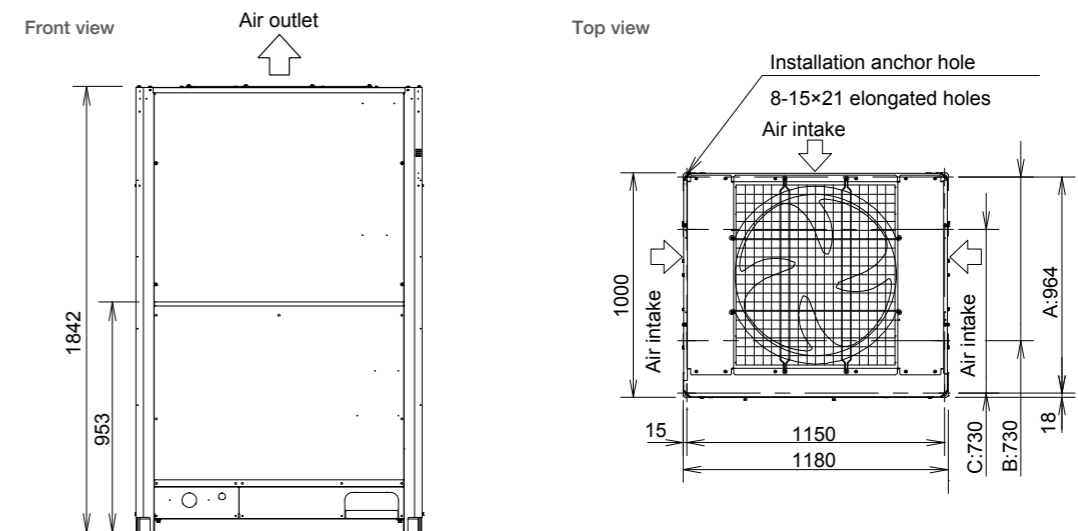

unit: mm

Piping design

Select the installation location so that the length and size of refrigerant piping are within the allowable range shown in the figure below.

- Main piping length (maximum tubing size) LM = LA + LB ...
- Main distribution tubes LC - LH are selected according to the capacity after the distribution joint.
- The outdoor connection main piping (LO portion) is determined by the total capacity of the outdoor units that are connected to the pipe ends.
- Sizes of indoor unit connection piping ℓ1 - ℓ52 are determined by the connection piping sizes on the indoor units.

R410A optional distribution joint
 CZ-P680PH2 (for outdoor unit)
 CZ-P1350PH2 (for outdoor unit)
 CZ-P224BH2 (for indoor unit)
 CZ-P680BH2 (for indoor unit)
 CZ-P1350BH2 (for indoor unit)

Explanation of symbols

- Distribution joint (CZ: optional parts)
- Ball valve (field supply)
- T-joint (field supply)
- Solidly welded shut (pinch weld)

* Be sure to use special R410A distribution joints (CZ: optional parts) for outdoor unit connections and piping branches.

Table 2 Ranges that Apply to Refrigerant piping Lengths and to Differences in Installation Heights

Ranges that apply to refrigerant piping lengths and to differences in installation heights

Item	Mark	Contents	Length (m)
Allowable piping length	L1	Max. piping length	Actual length $\leq 200^{*2}$ Equivalent length $\leq 210^{*2}$
	$\Delta L (L2 - L4)$	Difference between max. length and min. length from the 1st distribution joint	$\leq 50^{*4}$
	LM	Max. length of main piping (at maximum size) *Even after 1st distribution joint, LM is allowed if at maximum piping length.	— ^{*3}
	ℓ1, ℓ2 - ℓ52	Max. length of each distribution pipe	$\leq 50^{*5}$
	$L1 + \ell1 + \ell2 - \ell51 + \ell A + \ell B + \ell F + \ell G + \ell H$	Total max. piping length including length of each distribution pipe (only liquid pipe)	≤ 500
	$\ell A, \ell B + \ell O, \ell C + \ell O$	Maximum piping length from outdoor's 1st distribution joint to each outdoor unit	≤ 10
	$\ell1 - 2, \ell2 - 2 - \ell52 - 2$	Max. length between solenoid valve kit and indoor unit	≤ 30
Allowable elevation difference	H1	When outdoor unit is installed higher than indoor unit	≤ 50
	H2	When outdoor unit is installed lower than indoor unit	≤ 40
	H3	Max. difference between indoor units	≤ 15
Allowable length of joint piping	L3	T-joint piping (field-supply); Max. piping length between the first T-joint and solidly welded-shut end point	≤ 2

- L = Length, H = Height
- The outdoor connection main piping (LO portion) is determined by the total capacity of the outdoor units that are connected to the pipe ends.
 - If the longest piping length (L1) exceeds 90 m (equivalent length), increase the sizes of the main pipe (LM) by 1 rank for the suction pipe, discharge pipe and liquid pipe. Use a field supply reducer. Select the pipe size from the table of main piping sizes (Table 3) and from the table of refrigerant piping sizes (Table 8).
 - If the longest main piping length (LM) exceeds 50 m, increase the main piping size at the portion before 50 m by 1 rank for the suction pipe and discharge pipe. Use a field supply reducer. Determine the length less than the limitation of allowable maximum piping length. For the portion that exceeds 50 m, set based on the main piping size (LA) listed in Table 3.
 - If the piping length marked "L" (L2-L4) exceeds 40 m, increase the piping size at the portion after the 1st distribution joint by 1 rank for the liquid pipe, suction pipe and discharge pipe. Refer to the Technical Data for the details.
 - If any of the piping length exceeds 30m, increase the size of the suction pipe, discharge pipe and liquid pipe by 1rank.

System limitations

Max. number of combined outdoor units	3
Max. HP of combined outdoor units	135kW(48HP)
Max. number of connectable indoor units	52
Indoor/outdoor unit capacity ratio	50-150%

*1: In the case of 24 HP (type 68.0 kW) or smaller units, the number is limited by the total capacity of the connected indoor units.
 *2: Up to 3 units can be connected if the system has been extended.
 *3: It is strongly recommended that you choose the unit so the load can become between 50 and 130 %.

Additional refrigerant charge

Liquid piping size mm (inches)	Amount of refrigerant charge/m (g/m)
ø6.35 (ø1/4)	26
ø9.52 (ø3/8)	56
ø12.7 (ø1/2)	128
ø15.88 (ø5/8)	185
ø19.05 (ø3/4)	259
ø22.22 (ø7/8)	366

Necessary Amount of Additional Refrigerant Charge per meter, According to Discharge Piping Size

Discharge piping size	mm	ø12.7	ø15.88	ø19.05	ø22.22	ø25.4	ø28.58	ø31.75	ø38.1
Additional amount	g/m	12	21	31	41	55	71	89	126

*Additional refrigerant charge amount of discharge piping should be less than 9,000g.

Distribution joint kits

Remarks	Model name	Cooling capacity after distribution
For outdoor unit	1. CZ-P680PH2	68.0 kW or less
	2. CZ-P1350PH2	118.0 kW or less
For indoor unit	3. CZ-P224BH2	22.4 kW or less
	4. CZ-P680BH2	68.0 kW or less
	5. CZ-P1350BH2	118.0 kW or less

Refrigerant piping

Piping size mm (inches)			
Material O		1/2 H, H material	
Outer diameter	Wall thickness	Outer diameter	Wall thickness
ø6.35 (ø1/4)	t 0.8 mm	ø22.22 (ø7/8)	t 1.0 mm
ø9.52 (ø3/8)	t 0.8 mm	ø 25.4 (ø1)	t 1.0 mm
ø12.7 (ø1/2)	t 0.8 mm	ø 28.58 (ø1-1/8)	t 1.0 mm
ø15.88 (ø5/8)	t 1.0 mm	ø 31.75 (ø1-1/4)	t 1.1 mm
ø19.05 (ø3/4)	t 1.0 mm	ø 38.1 (ø1-1/2)	t 1.15 mm
		ø 41.28 (ø1-5/8)	t 1.20 mm

Note: When pipe bending is to be performed, the bending radius shall be at least 4 times the outer diameter. Also, take sufficient care to prevent pipe collapse and damage at the time of bending.

Refrigerant Branch Pipes (optional accessories) for 3-PIPE MF3 Series

Optional Distribution Joint Kits

See the installation instructions packaged with the distribution joint kit for the installation procedure.

Model name	capacity after distribution JOINT	Remarks
1. CZ-P680PH2	68.0 kW or less	For outdoor unit
2. CZ-P1350PH2	greater than 68.0 kW and no more than 135.0 kW	For outdoor unit
3. CZ-P224BH2	22.4 kW or less	For indoor unit
4. CZ-P680BH2	greater than 22.4 kW and no more than 68.0 kW	For indoor unit
5. CZ-P1350BH2	greater than 68.0 kW and no more than 135.0 kW	For indoor unit

1. CZ-P680PH2

Use: For outdoor unit (Capacity after distribution joint is 68.0 kW or less.)

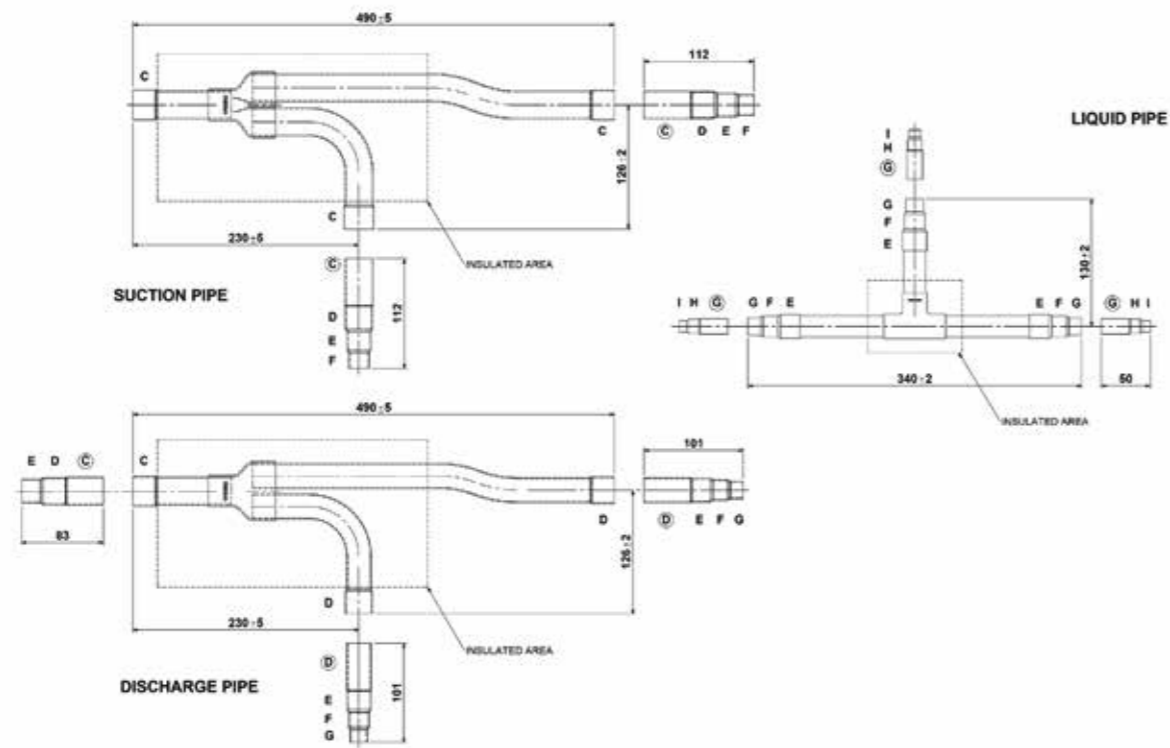

All measurements are in mm. Size of connection points on each part shown are inside diameters of piping.

2. CZ-P1350PH2

Use: For outdoor unit (Capacity after distribution joint is greater than 68.0 kW and no more than 135.0 kW.)

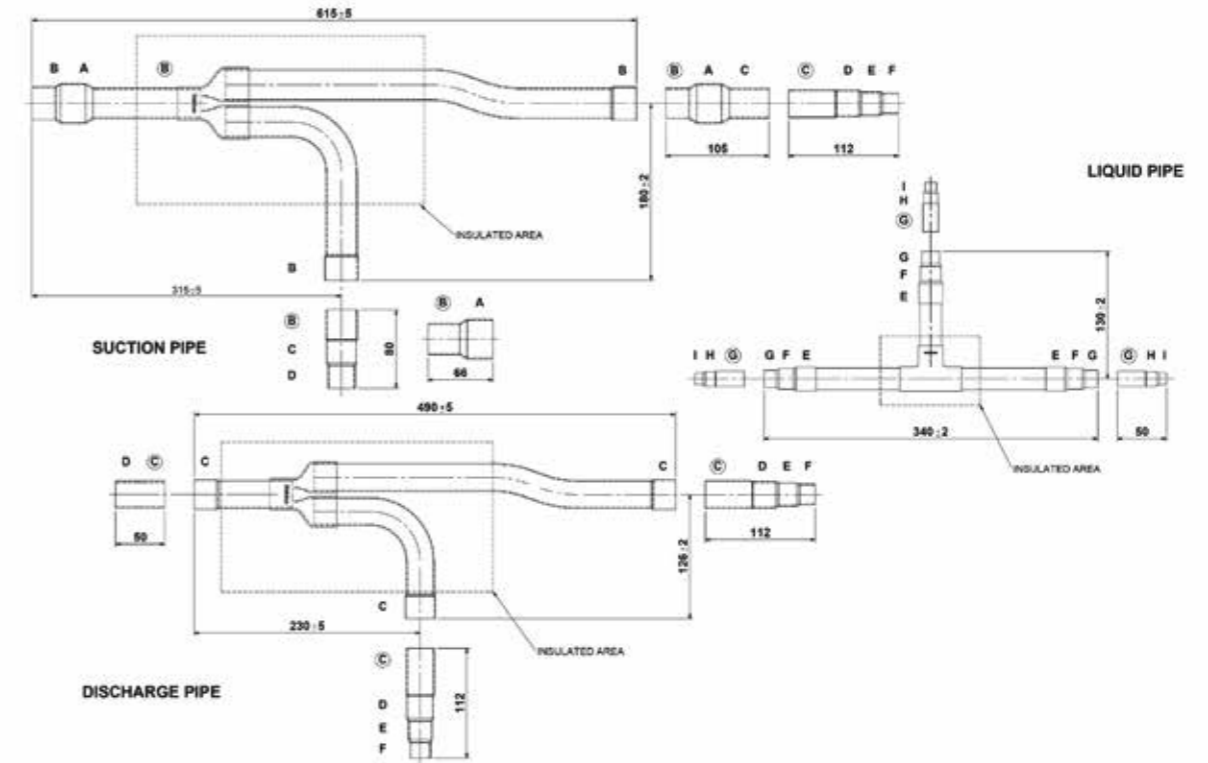

All measurements are in mm. Size of connection points on each part shown are inside diameters of piping.

3. CZ-P224BH2

Use: For indoor unit (Capacity after distribution joint is 22.4 kW or less.)

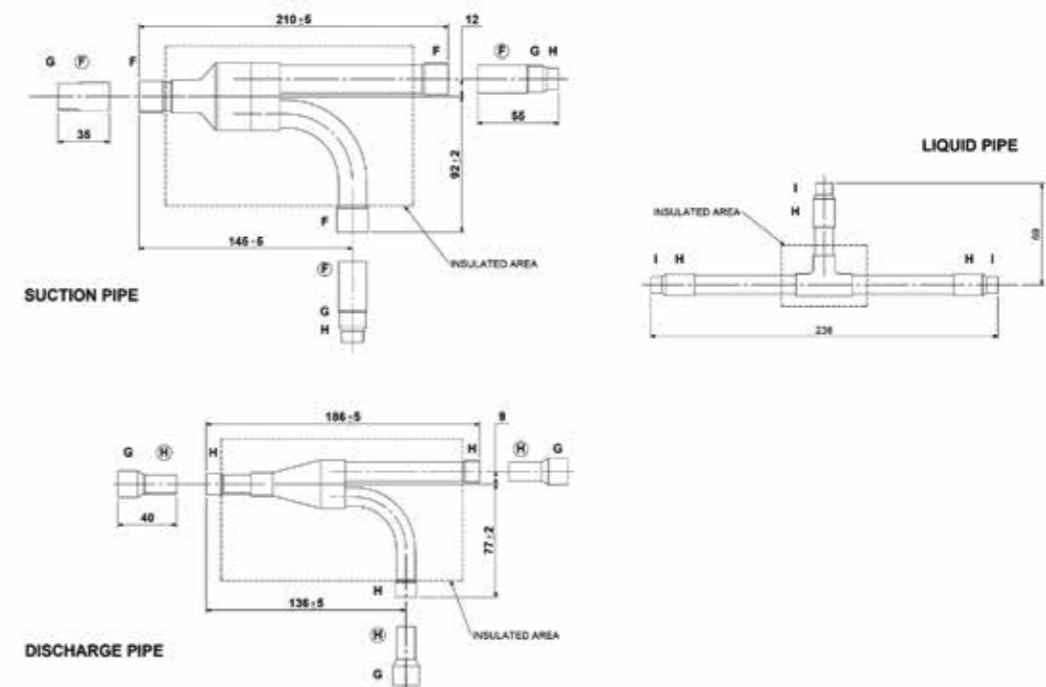

All measurements are in mm. Size of connection points on each part shown are inside diameters of piping.

Refrigerant Branch Pipes (optional accessories) for 3-PIPE MF3 Series

4. CZ-P680BH2

Use: For indoor unit (Capacity after distribution joint is greater than 22.4 kW and no more than 68.0 kW.)

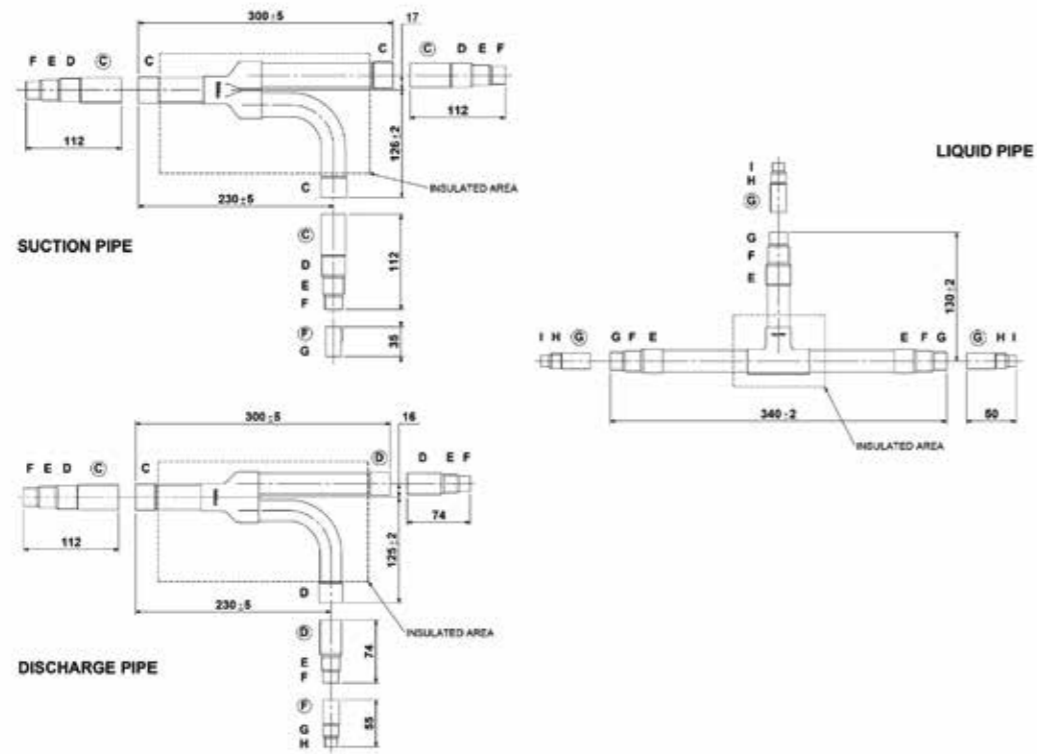

All measurements are in mm. Size of connection points on each part shown are inside diameters of piping.

5. CZ-P1350BH2

Use: For indoor unit (Capacity after distribution joint is greater than 68.0 kW and no more than 135.0 kW.)

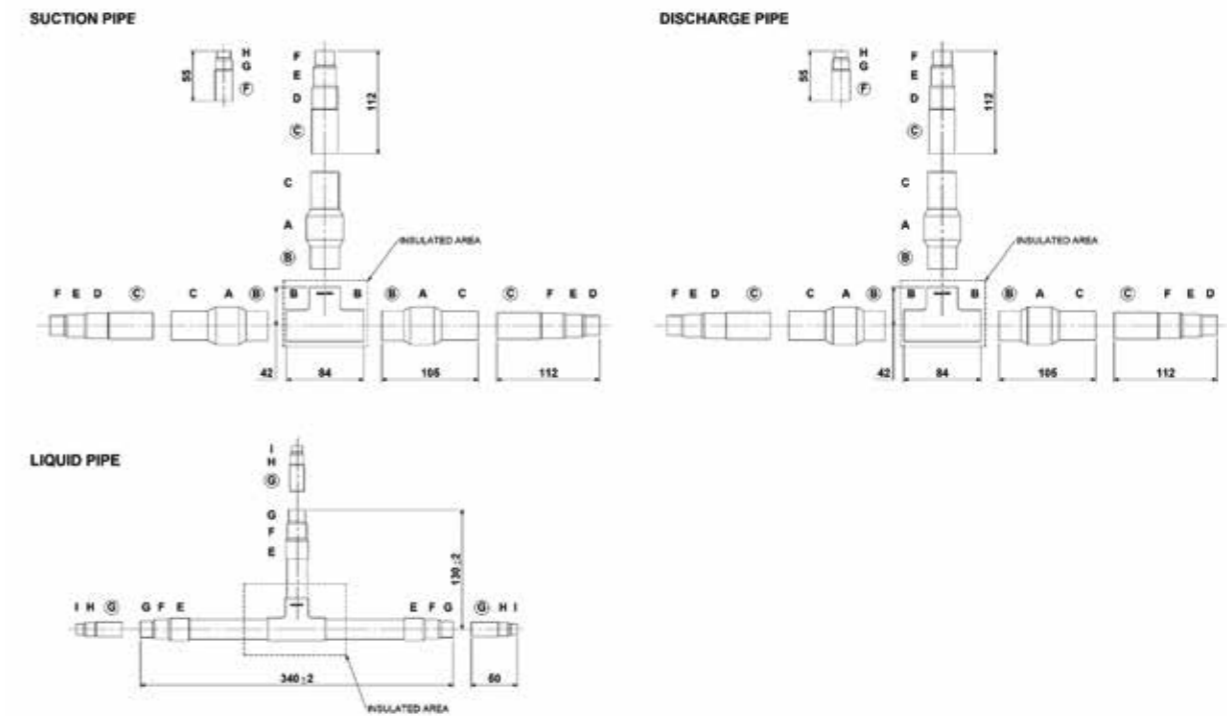

All measurements are in mm. Size of connection points on each part shown are inside diameters of piping.



2-PIPE Mini-VRF LE/LZ Series

High External Static Pressure 35Pa

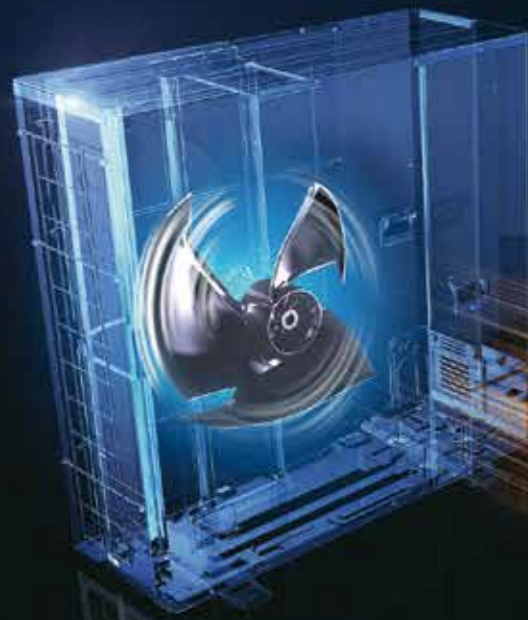

High external static pressure 35Pa

When unit is installed on a narrow balcony and exposed to the sun, the fence at the front side would restrict hot air from being discharged. Heat accumulated in an enclosure can cause over-heating. This could potentially result in damage or shorten the product's life span. A high external static pressure sends the air further away from the outdoor unit and through the fence. This provides better air circulation and distribution.



Previous model - Low pressure

When the pressure is low, hot air will accumulate in the unit thus affecting its work performance and of the unit above it as well.

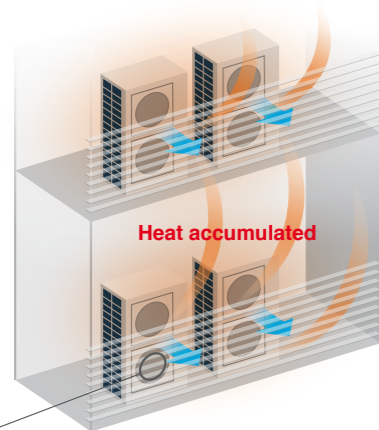

Previous fan

High electrostatic pressure disrupted the airflow of the previous fan, lowering the air pressure and preventing hot air from being discharged far enough.



LE/LZ series - High pressure

But with a high pressure of 35Pa, hot air is sent further away preventing overheating inside the outdoor unit enclosure.

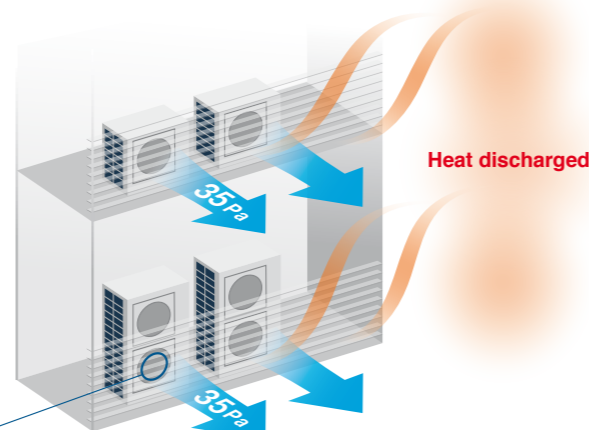

LE/LZ series fan

The new LE/LZ Series fan has ribs extending near the blade tips, in a structure that resists deformation. During high electrostatic pressure, this blade shape suppresses disruptions in the airflow, and a high air pressure of 35 Pa discharges the hot air a sufficient distance.



Long piping design length for greater design flexibility

LE1 LE2 LZ2

Adaptable to various building types and sizes

Actual piping length 150m (equivalent piping length 175m)

Max. total piping length: 300m

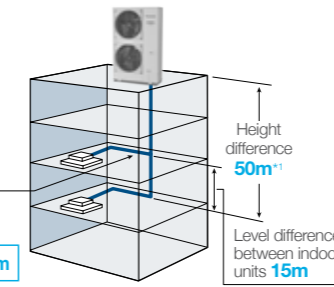

LE1

Actual piping length 150m (equivalent piping length 175m)

Max. total piping length: 180m

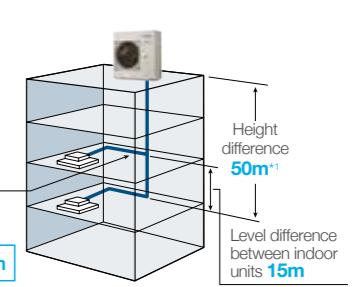

LE2

Actual piping length 100m (equivalent piping length 125m)

Max. total piping length: 300m

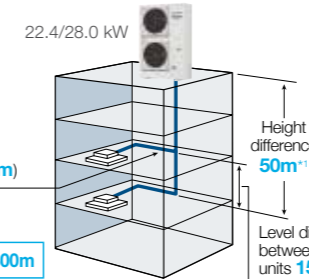

Actual piping length 90m (equivalent piping length 115m)

Max. total piping length: 180m

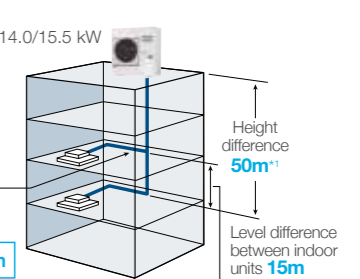

LZ2

*1: 40m if the outdoor unit is below the indoor unit.

Refrigerant chargeless up to 50m

LE2

Up to 50m of piping without additional gas charging makes installation flexible, easy and hassle-free.

A 50m pipe length is sufficient for most residential and small business buildings. When total piping length exceeds 50m, additional refrigerant charge is required.

Chargeless
Max. total piping length: 50m

Charge
Max. total piping length: 180m (Actual length: 150m)

[Sample piping lay-out]

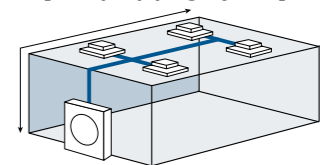

Compact design

LE1 LE2 LZ2

Also, since Mini VRF LE/LZ Series is a single unit, it is possible to install the unit in more various places compared to the Single Split system.

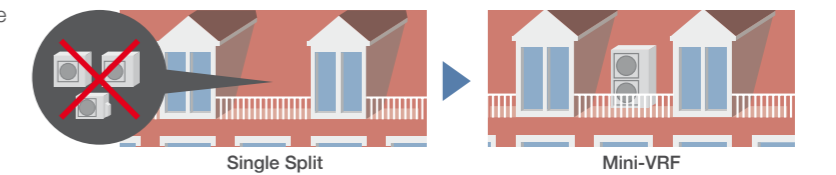

Short height of 996mm

LE2 LZ2

In addition to raising efficiency, we have made the outdoor unit more compact. It can now be installed in places that were previously too small.

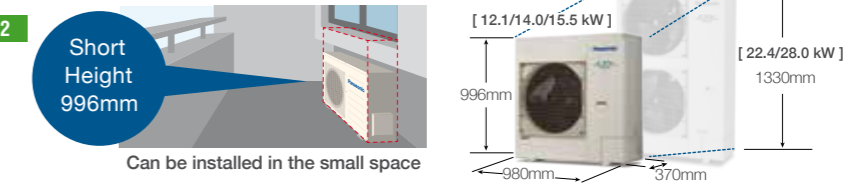

Wide range of connectable indoor units

LE1 LE2 LZ2

An expansion from Panasonic VRF line up, the Mini-VRF is compatible with the same indoor units and controls as the rest of the VRF range.

Connecting image

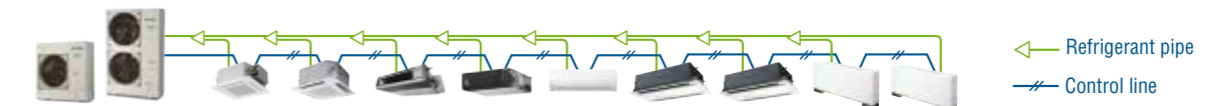

Maximum connectable indoor units and allowable indoor/outdoor capacity ratio

Model	Max connectable indoor units	Max allowable indoor/outdoor capacity ratio	Model	Max connectable indoor units	Max allowable indoor/outdoor capacity ratio
U-4LE2R5	7pcs.	50~130%	U-4LZ2E5	7pcs.	50~150%
U-4LE2R8			U-4LZ2E8		
U-5LE2R5	8pcs.	50~130%	U-5LZ2E5	8pcs.	50~150%
U-5LE2R8			U-5LZ2E8		
U-6LE2R5	9pcs.	50~130%	U-6LZ2E5	9pcs.	50~150%
U-6LE2R8			U-6LZ2E8		
U-8LE1R8	15pcs.	50~150%	U-8LZ2E8	15pcs.	50~150%
U-10LE1R8			U-10LZ2E8		

2-PIPE Mini-VRF LE/LZ Series

High efficiency

LE1 LE2 LZ2

The operation efficiency has been improved using highly efficient refrigerant, a DC Inverter compressor, DC motor and a heat exchanger design.

COOLING

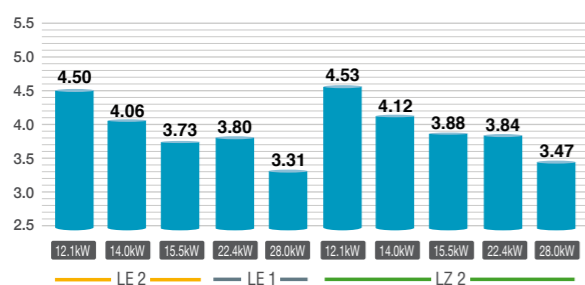

HEATING

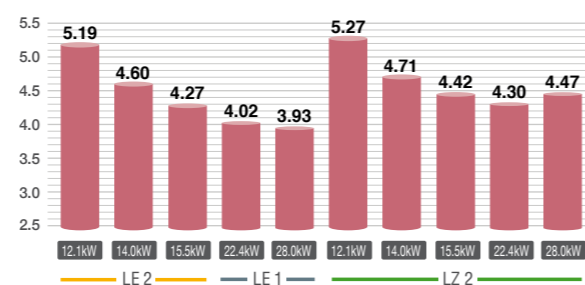

Energy savings design

LE1 LE2 LZ2

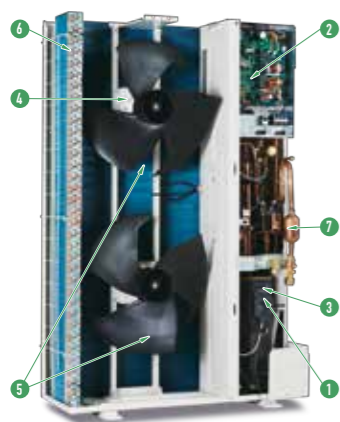

- Panasonic Inverter Compressor** A large-capacity inverter compressor has been adopted. The inverter compressor is superior in performance with improved partial-load capacity.
- Printed Circuit Board** The number of PCB is 2 pieces for making maintenance easier.
- Accumulator** A large accumulator has been adopted to maintain compressor reliability because of the increased refrigerant quantity, which allows an extended max piping length.
- DC Fan Motor** Checking load and outside temperature, the DC motor is controlled for optimum air volume.
- Newly Designed Fan** The newly designed fan blades have been developed to inhibit air turbulence and to increase efficiency. As fan diameter has been increased its size, the air volume has been increased whilst maintaining a same sound level.
- Heat Exchanger & Copper Tubes** The heat exchanger size and the copper tube sizes in the heat exchanger have been redesigned to increase efficiency.
- Oil Separator** A centrifugal separator has been adopted to improve oil separation efficiency and reduce refrigerant pressure loss.

Flexible demand response with the optional terminal block

LE1 LE2 LZ2

Demand response

Featuring inverter control technology, LE1,LE2,LZ2* series systems are Demand Response Management (DRM) ready. With this control, power consumption at times of peak load can be set in three steps to deliver optimum performance. This helps to correspond with the local power management for reducing peak power consumption, and to reduce annual power consumption with minimal loss in comfort.

*LZ2 series require to purchase Demand Terminal Kit.

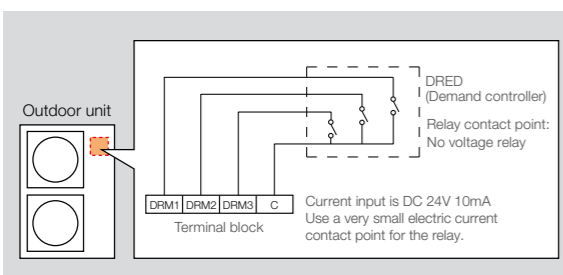

Demand control setting level and unit behavior image

To use this function with the LZ2 series, it is necessary to purchase the Demand Terminal Kit (CZ-CAPDC3) (sold separately), install it on the outdoor unit at the site, and perform the appropriate settings. (LE1 and LE2 series have terminals as standard equipment.)

A maintenance remote controller for service and special connection wiring are required for setting up the outdoor unit after installation of the kit, please contact your dealer for details.

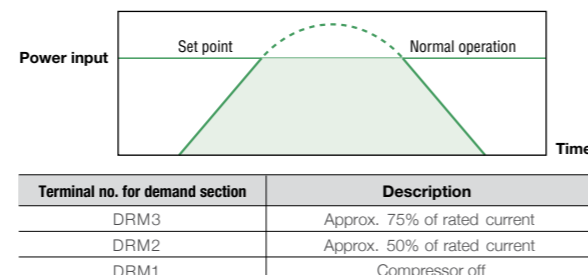

Wide operating range

LE1 LE2 LZ2

- Cooling operation is possible even when outdoor temperature is as low as -10°C DB.
- Cooling operation is possible even when outdoor temperature is as high as 52°C DB. (LZ2 series)
- Heating operation is possible even when outdoor temperature is as low as -20°C WB.

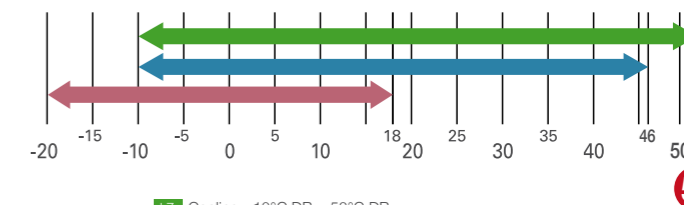

The remote controller temperature can be set from 18°C up to 30°C (Cooling), 16°C up to 30°C (Heating)*1.

*1 Depending on the type of remote controller.

Outdoor Blue fin condenser

LE1 LE2 LZ2

The anti-corrosion Blue Fin treatment of the heat exchanger provides greater resistance against corrosion. All models are equipped with Blue Fin condenser.

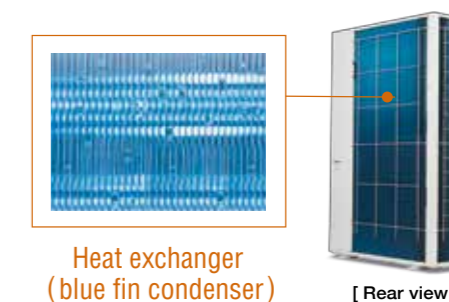

High durability outdoor unit

LE1 LE2

Corrosion-resistance treated for high resistance to rust and salty air to assure long-lasting performance.

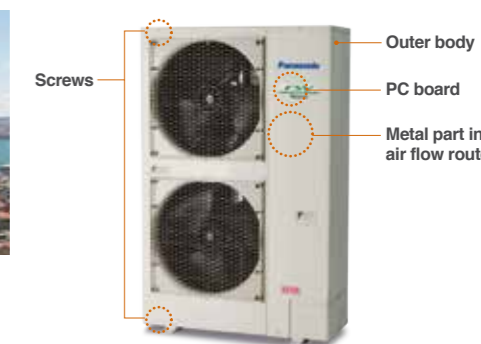

Note: Selecting this unit does not completely eliminate the possibility of rust developing. For details concerning unit installation and maintenance, please consult an authorised dealer.

* Specific model with suffix "E" has this treatment.

Quiet operation mode

LE1 LE2 LZ2

- Quiet operation mode reduces outdoor unit operating sound down to 7dB than rating.
- 3-step set point is available.
- External input signal is also available.

* Timer setting of quiet operation mode is available in High-spec Remote Controller (CZ-RTC5B/CZ-RTC6 series).



2-PIPE Mini-FSV LE2 Series

kW		12.1		12.1		14.0		14.0		15.5		15.5			
Model name		U-4LE2R5		U-4LE2R8		U-5LE2R5		U-5LE2R8		U-6LE2R5		U-6LE2R8			
Power supply		230/240V/1-phase/50Hz		400/415V/3-phase/50Hz		230/240V/1-phase/50Hz		400/415V/3-phase/50Hz		230/240V/1-phase/50Hz		400/415V/3-phase/50Hz			
Voltage		230V	240V	400V	415V	230V	240V	400V	415V	230V	240V	400V	415V		
Capacity	Cooling	kW	12.1	12.1	14.0	14.0	15.5	15.5	15.5	15.5	15.5	15.5	15.5		
		BTU/h	41,300	41,300	47,800	47,800	52,900	52,900	52,900	52,900	52,900	52,900	52,900		
	Heating	kW	12.5	12.5	16.0	16.0	16.5	16.5	16.5	16.5	16.5	16.5	16.5		
		BTU/h	42,700	42,700	54,600	54,600	56,300	56,300	56,300	56,300	56,300	56,300	56,300		
EER/COP	Cooling	W/W	4.50	4.50	4.06	4.06	3.73	3.73	3.73	3.73	3.73	3.73	3.73		
	Heating	W/W	5.19	5.19	4.60	4.60	4.27	4.27	4.27	4.27	4.27	4.27	4.27		
Dimensions (H/W/D)		996 x 980 x 370		996 x 980 x 370		996 x 980 x 370		996 x 980 x 370		996 x 980 x 370		996 x 980 x 370			
Net weight		kg		106		106		106		106		106			
Electrical ratings	Cooling	Running current	A	12.70	12.20	4.17	4.02	16.30	15.60	5.30	5.11	19.40	18.60	6.37	6.14
		Power input	kW	2.69	2.69	2.69	2.69	3.45	3.45	3.45	3.45	4.15	4.15	4.15	4.15
	Heating	Running current	A	11.60	11.20	3.78	3.64	16.60	15.90	5.34	5.15	18.20	17.50	5.93	5.71
		Power input	kW	2.41	2.41	2.41	2.41	3.48	3.48	3.48	3.48	3.86	3.86	3.86	3.86
Starting current		A		1		1		1		1		1			
Air flow rate		m ³ /h		4,140		4,140		4,320		4,320		4,440		4,440	
		L/s		1,150		1,150		1,200		1,200		1,233		1,233	
Refrigerant amount at shipment		kg		R410A 6.70		R410A 6.70		R410A 6.70		R410A 6.70		R410A 6.70			
Piping connection	Gas pipe	mm (inches)	Ø15.88 (Ø5/8)		Ø15.88 (Ø5/8)		Ø15.88 (Ø5/8)		Ø15.88 (Ø5/8)		Ø15.88 (Ø5/8)		Ø15.88 (Ø5/8)		
	Liquid pipe	mm (inches)	Ø9.52 (Ø3/8)		Ø9.52 (Ø3/8)		Ø9.52 (Ø3/8)		Ø9.52 (Ø3/8)		Ø9.52 (Ø3/8)		Ø9.52 (Ø3/8)		
Ambient temperature operating range		Cooling: -10°CDB~+46°CDB, Heating: -20°CWB~+18°CWB		Cooling: -10°CDB~+46°CDB, Heating: -20°CWB~+18°CWB		Cooling: -10°CDB~+46°CDB, Heating: -20°CWB~+18°CWB		Cooling: -10°CDB~+46°CDB, Heating: -20°CWB~+18°CWB		Cooling: -10°CDB~+46°CDB, Heating: -20°CWB~+18°CWB		Cooling: -10°CDB~+46°CDB, Heating: -20°CWB~+18°CWB		Cooling: -10°CDB~+46°CDB, Heating: -20°CWB~+18°CWB	
Sound pressure level (Cooling)	Normal mode	dB(A)	52.0		52.0		53.0		53.0		54.0		54.0		
	Silent mode (3)	dB(A)	45.0		45.0		46.0		46.0		47.0		47.0		
Sound power level (Cooling)		Normal mode		dB		69.0		69.0		71.0		71.0		73.0	

Global remarks	Rated conditions:		Cooling	Heating
	Indoor air temperature		27°C DB / 19°C WB	20°C DB
	Outdoor air temperature		35°C DB	7°C DB / 6°C WB

These specifications are subject to change without notice. High durable model (with suffix "E") has same specifications. Applies to single phase models only.

2-PIPE Mini-FSV LE1 Series

kW		22.4		28.0			
Model name		U-8LE1R8		U-10LE1R8			
Power supply		400/415V/3-phase/50Hz 380/400V/3-phase/60Hz		400/415V/3-phase/50Hz 380/400V/3-phase/60Hz			
Voltage		400V	415V	400V	415V		
Capacity	Cooling	kW	22.4	25.0	28.0		
		BTU/h	76,500	85,300	95,600		
	Heating	kW	25.0	28.0	31.1		
		BTU/h	85,300	95,600	106,300		
EER/COP	Cooling	W/W	3.80	3.31	3.93		
	Heating	W/W	4.02	3.93	3.93		
Dimensions (H/W/D)		mm		1,500 x 980 x 370			
Net weight		kg		132			
Electrical ratings	Cooling	Running current	A	9.15	8.80	11.70	11.30
		Power input	kW	5.89	5.89	7.55	7.55
	Heating	Running current	A	9.65	9.30	11.10	10.70
		Power input	kW	6.22	6.22	7.13	7.13
Starting current		A		1			
Air flow rate		m ³ /h		9,000			
		L/s		2,500			
Refrigerant amount at shipment		kg		R410A 6.30			
Piping connection	Gas pipe	mm (inches)	Ø19.05 (Ø3/4)		Ø22.22 (Ø7/8)		
	Liquid pipe	mm (inches)	Ø9.52 (Ø3/8)		Ø9.52 (Ø3/8)		
Ambient temperature operating range		Cooling: -10°CDB~+46°CDB, Heating: -20°CWB~+18°CWB		Cooling: -10°CDB~+46°CDB, Heating: -20°CWB~+18°CWB			
Sound pressure level (Cooling)	Normal mode	dB(A)	60.0		62.0		
	Silent mode (3)	dB(A)	53.0		55.0		
Sound power level (Cooling)		Normal mode		dB		81.0	

Global remarks	Rated conditions:		Cooling	Heating
	Indoor air temperature		27°C DB / 19°C WB	20°C DB
	Outdoor air temperature		35°C DB	7°C DB / 6°C WB

These specifications are subject to change without notice. Anti-corrosion model (with suffix "E") has the same specifications.

Dimensions

U-4LE2R5 / U-4LE2R8
U-5LE2R5 / U-5LE2R8
U-6LE2R5 / U-6LE2R8

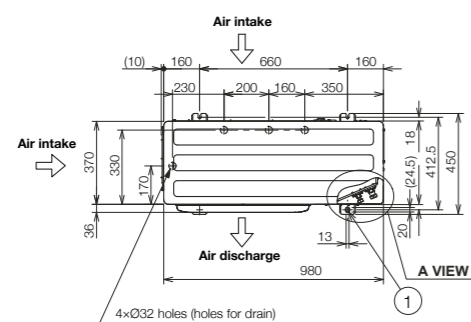

- ① Mounting hole (4-R6.5), anchor bolt : M10
- ② Refrigerant tubing (liquid tube), flared connection (Ø9.52)
- ③ Refrigerant tubing (gas tube), flared connection (Ø15.88)
- ④ Refrigerant tubing port
- ⑤ Electrical wiring port (Ø13)
- ⑥ Electrical wiring port (Ø22)
- ⑦ Electrical wiring port (Ø27)
- ⑧ Electrical wiring port (Ø35)

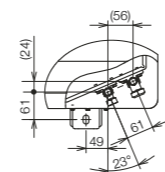

A VIEW

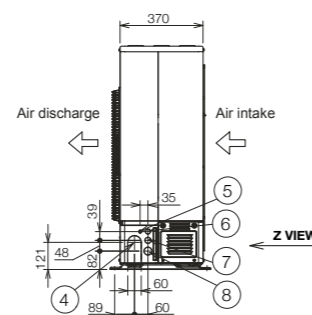
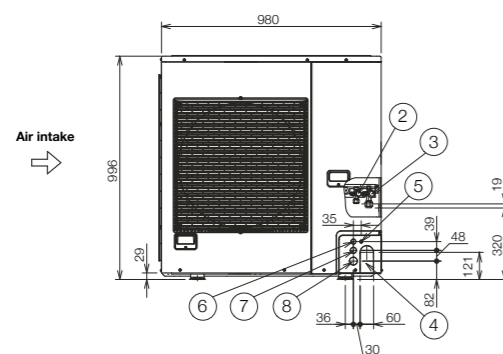

Z VIEW

Unit: mm

Dimensions

U-8LE1R8 / U-10LE1R8

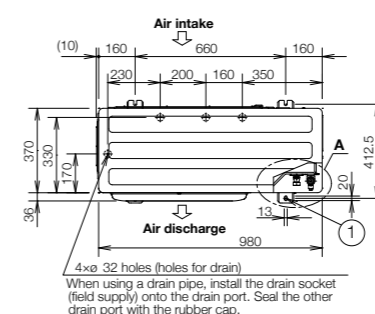

- ① Mounting hole (4-R6.5), anchor bolt : M10
- ② Refrigerant tubing (liquid tube), flared connection (Ø9.52) for 8-10 HP finally.
- ③ Refrigerant tubing (gas tube), flared connection (Ø19.05)
- ④ Refrigerant tubing port
- ⑤ Electrical wiring port (Ø13)
- ⑥ Electrical wiring port (Ø22)
- ⑦ Electrical wiring port (Ø27)
- ⑧ Electrical wiring port (Ø35)

For U-10LE1H7
The tubing of the gas main has a diameter of ø22.22, but the connection to the service valve of the outdoor unit has a diameter of ø19.05, so a flare has to be used. Consequently, be sure to use the enclosed joint tube B and joint tube A in making connections (braze).

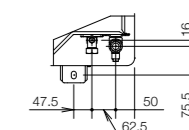

A VIEW

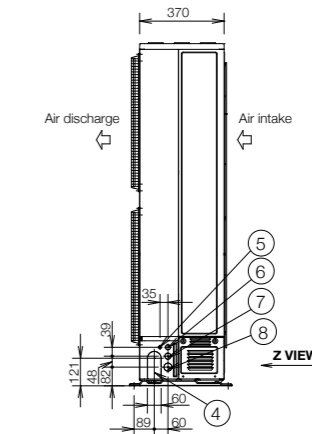
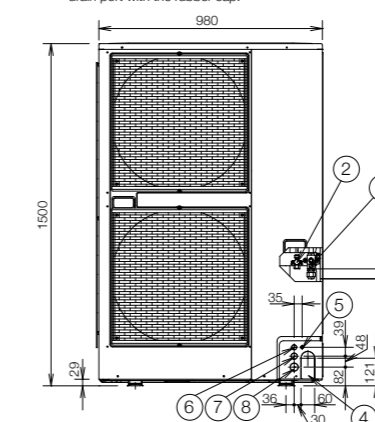

Z VIEW

Unit: mm

2-PIPE Mini-VRF LZ2 Series

kW		12.1		12.1		14.0		14.0		15.5		15.5	
Model name		U-4LZ2E5		U-4LZ2E8		U-5LZ2E5		U-5LZ2E8		U-6LZ2E5		U-6LZ2E8	
Power supply		230/240V/1-phase/50Hz		400/415V/3-phase/50Hz		230/240V/1-phase/50Hz		400/415V/3-phase/50Hz		230/240V/1-phase/50Hz		400/415V/3-phase/50Hz	
Voltage		230V	240V	400V	415V	230V	240V	400V	415V	230V	240V	400V	415V
Capacity	Cooling	kW		12.1		14.0		14.0		15.5		15.5	
		BTU/h		41,300		47,800		47,800		52,900		52,900	
EER/COP	Cooling	W/W		4.53		4.12		4.12		3.88		3.88	
	Heating	W/W		5.27		4.71		4.71		4.42		4.42	
Dimensions (H/W/D)		mm		996 x 980 x 370		996 x 980 x 370		996 x 980 x 370		996 x 980 x 370		996 x 980 x 370	
Net weight		kg		94		94		94		94		94	
Electrical ratings	Cooling	Running current	A	12.80	12.20	4.15	4.00	16.20	15.50	5.23	5.04	17.70	18.00
		Power input	kW	2.67		2.67		3.40		3.40		4.00	
	Heating	Running current	A	11.40	11.00	3.71	3.58	16.20	15.20	5.22	5.03	17.71	17.00
		Power input	kW	2.37		2.37		3.40		3.40		3.73	
Starting current		A		1		1		1		1		1	
Air flow rate		m³/h		4,140		4,320		4,320		4,440		4,440	
		L/s		1,150		1,200		1,200		1,233		1,233	
Refrigerant amount at shipment		kg		R32 2.7		R32 2.7		R32 2.7		R32 2.7		R32 2.7	
Piping connection	Gas pipe	mm (inches)		Ø15.88 (Ø5/8)		Ø15.88 (Ø5/8)		Ø15.88 (Ø5/8)		Ø15.88 (Ø5/8)		Ø15.88 (Ø5/8)	
	Liquid pipe	mm (inches)		Ø9.52 (Ø3/8)		Ø9.52 (Ø3/8)		Ø9.52 (Ø3/8)		Ø9.52 (Ø3/8)		Ø9.52 (Ø3/8)	
Ambient temperature operating range				Cooling:-10°CDB~+52°CDB, Heating:-20°CWB~+18°CWB		Cooling:-10°CDB~+52°CDB, Heating:-20°CWB~+18°CWB		Cooling:-10°CDB~+52°CDB, Heating:-20°CWB~+18°CWB		Cooling:-10°CDB~+52°CDB, Heating:-20°CWB~+18°CWB		Cooling:-10°CDB~+52°CDB, Heating:-20°CWB~+18°CWB	
Sound pressure level (Cooling)	Normal mode	dB(A)		52.0		52.0		53.0		53.0		54.0	
	Silent mode(1/2/3/4)	dB(A)		49.0/47.0/45.0/45.0		49.0/47.0/45.0/45.0		50.0/48.0/46.0/45.0		50.0/48.0/46.0/45.0		51.0/49.0/47.0/45.0	
Sound power level (Cooling)	Normal mode	dB		69.0		69.0		70.0		70.0		72.0	

Global remarks	Rated conditions:	
	Cooling	Heating
	Indoor air temperature	27°C DB / 19°C WB
	Outdoor air temperature	35°C DB

These specifications are subject to change without notice. High durable model (with suffix "E") has same specifications.

2-PIPE Mini-VRF LZ2 Series

kW		22.4		28.0	
Model name		U-8LZ2E8		U-10LZ2E8	
Power supply		400/415V/3-phase/50Hz			
Voltage		400V	415V	400V	415V
Capacity	Cooling	kW		22.4	
		BTU/h		76,500	
EER/COP	Cooling	W/W		3.84	
	Heating	W/W		4.30	
Dimensions (H/W/D)		mm			
Net weight		kg			
Electrical ratings	Cooling	Running current	A	9.25	8.91
		Power input	kW	5.83	
	Heating	Running current	A	9.32	8.98
		Power input	kW	5.81	
Starting current		A		1	
Air flow rate		m³/h		9,480	
		L/s		2,633	
Refrigerant amount at shipment		kg		R32 4.9	
Piping connection	Gas pipe	mm (inches)		Ø19.05 (Ø3/4)	
	Liquid pipe	mm (inches)		Ø9.52 (Ø3/8)	
Ambient temperature operating range		Cooling:-10°CDB~+52°CDB, Heating:-20°CWB~+18°CWB			
Sound pressure level (Cooling)	Normal mode	dB(A)		59.0	
	Silent mode(1/2/3/4)	dB(A)		56.0/54.0/52.0/50.0	
Sound power level (Cooling)	Normal mode	dB		72.0	

Global remarks	Rated conditions:	
	Cooling	Heating
	Indoor air temperature	27°C DB / 19°C WB
	Outdoor air temperature	35°C DB

These specifications are subject to change without notice. High durable model (with suffix "E") has same specifications.

Dimensions

U-4LZ2E5 / U-4LZ2E8
U-5LZ2E5 / U-5LZ2E8
U-6LZ2E5 / U-6LZ2E8

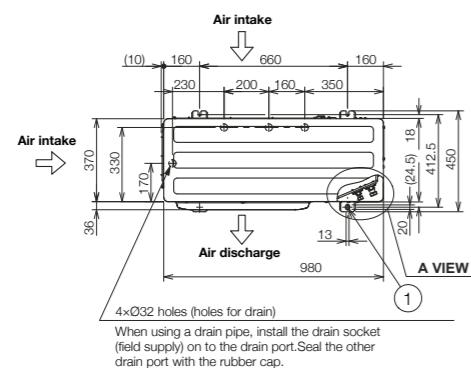

- ① Mounting hole (4-R6.5), anchor bolt : M10
- ② Refrigerant tubing (liquid tube), flared connection (Ø9.52)
- ③ Refrigerant tubing (gas tube), flared connection (Ø15.88)
- ④ Refrigerant tubing port
- ⑤ Electrical wiring port (Ø13)
- ⑥ Electrical wiring port (Ø22)
- ⑦ Electrical wiring port (Ø27)
- ⑧ Electrical wiring port (Ø35)

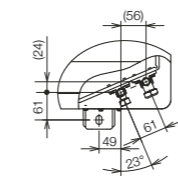

A VIEW

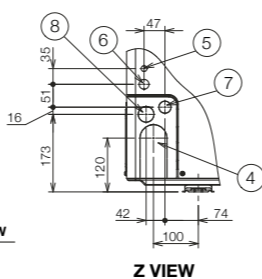
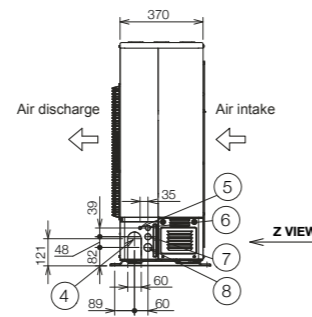
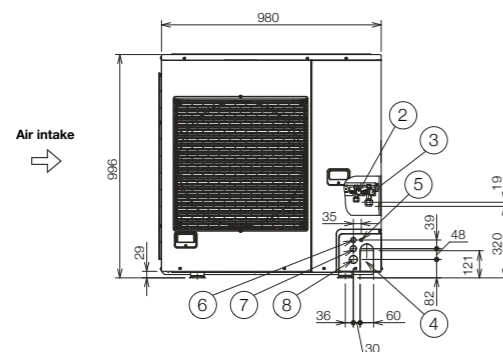

Unit: mm

Dimensions

U-8LZ2E8 / U-10LZ2E8

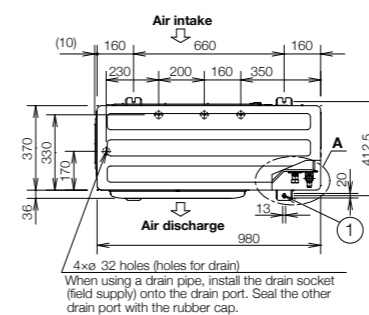

- ① Mounting hole (4-R6.5), anchor bolt : M10
- ② Refrigerant tubing (liquid tube), flared connection (ø9.52)
- ③ Refrigerant tubing (gas tube), flared connection (ø19.05)
- ④ Refrigerant tubing port
- ⑤ Electrical wiring port (ø13)
- ⑥ Electrical wiring port (ø22)
- ⑦ Electrical wiring port (ø27)
- ⑧ Electrical wiring port (ø35)

For U-10LZ2E8
The tubing of the gas main has a diameter of ø22.22, but the connection to the service valve of the outdoor unit has a diameter of ø19.05, so a flare has to be used. Consequently, be sure to use the enclosed joint tube B and joint tube A in making connections (braze).

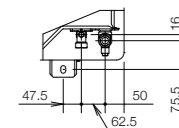

A VIEW

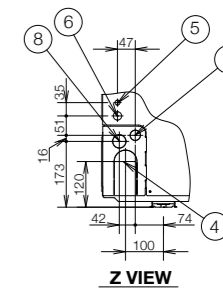
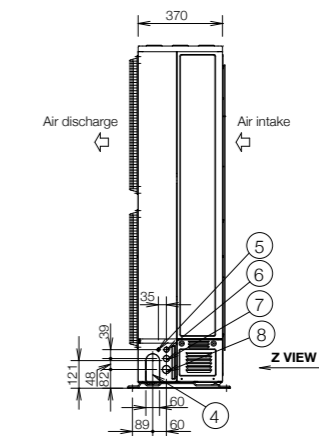
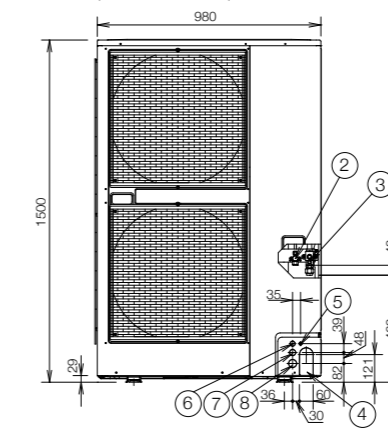

Unit: mm

2-PIPE Mini-VRF

Distribution Joint Kits

CZ-P160BK2

Use: For indoor unit (Capacity after distribution joint is 22.4 kW or less.)

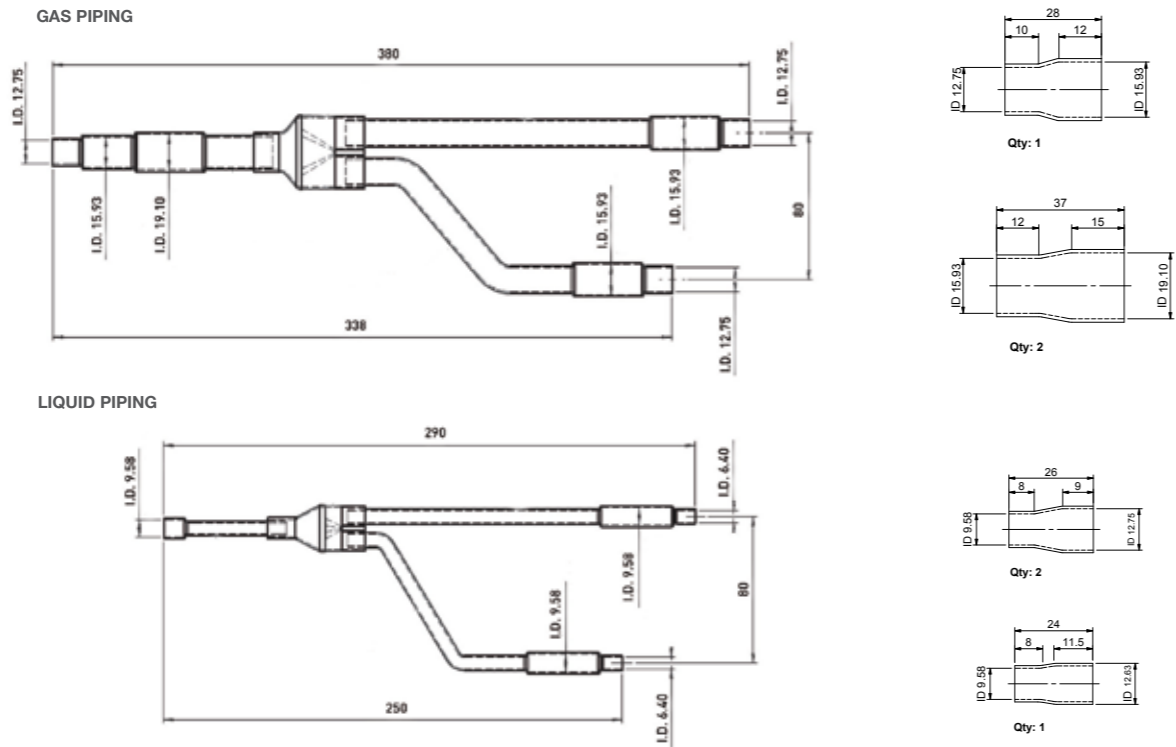

All measurements are in mm. Size of connection points on each part shown are inside diameters of piping.

Wiring System Diagrams

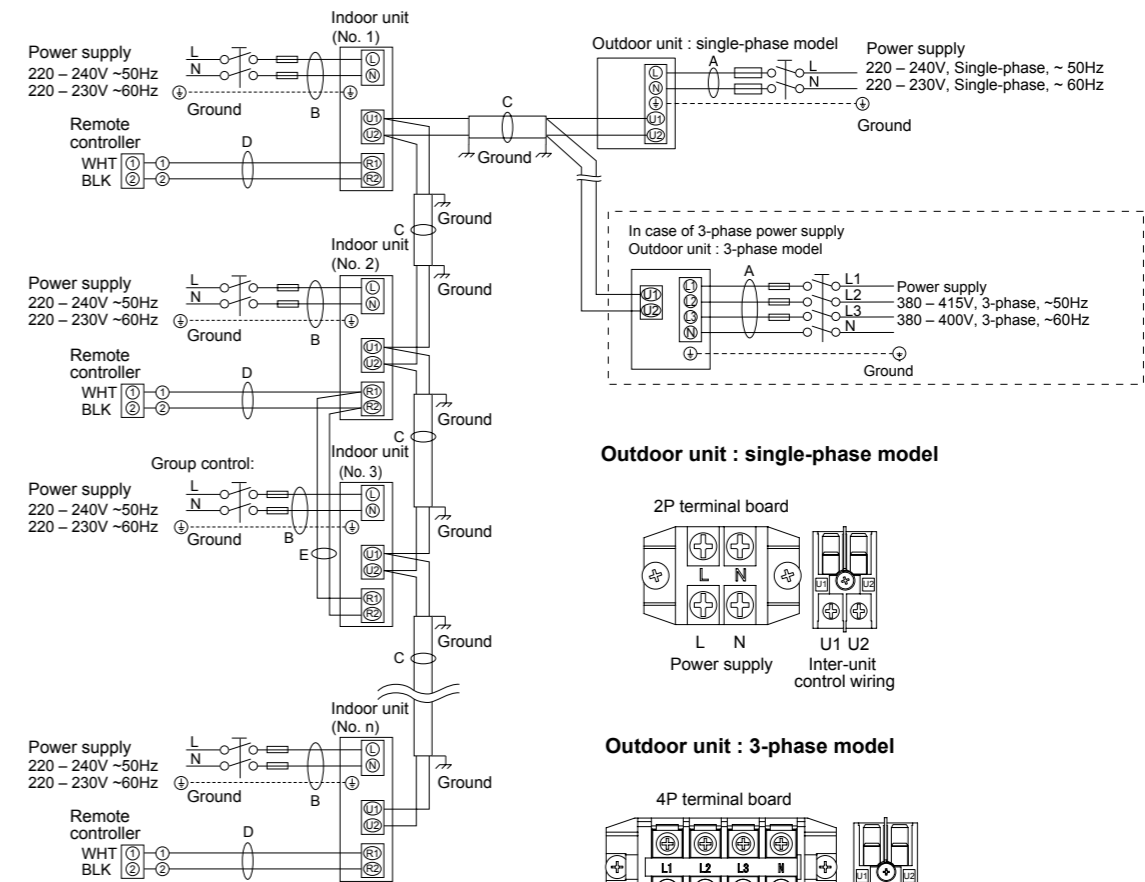

Outdoor unit : single-phase model

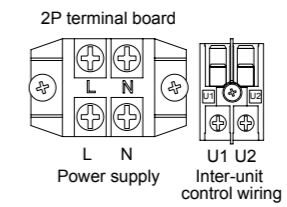

Outdoor unit : 3-phase model

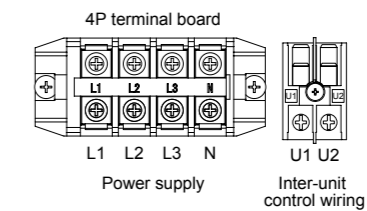

Indoor unit

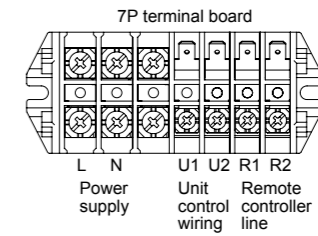

T1, F1, E1, D1, L1 Types

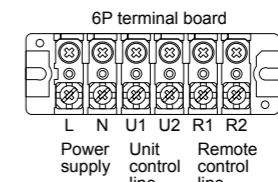

U1, Y1, M1, P1, R1 Types

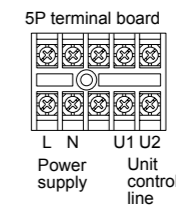

K1 Type

Fig. 2-1

2-PIPE Mini-VRF

Piping design

Select the installation location so that the length and size of refrigerant piping are within the allowable range shown in the figure below.

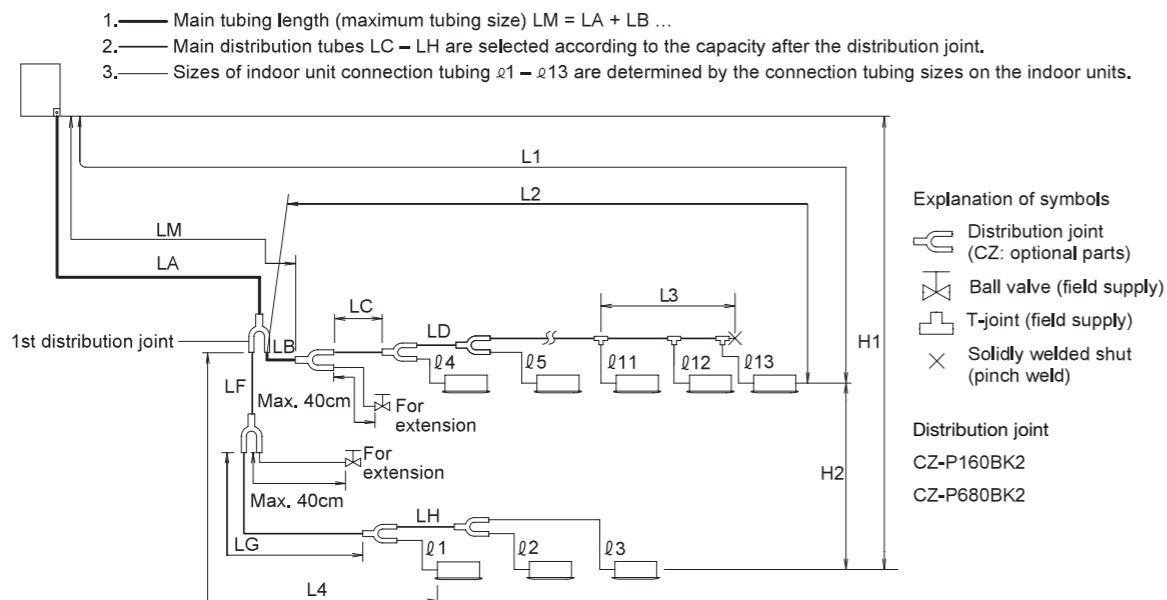

Ranges that Apply to Refrigerant Piping Lengths and to Differences in Installation Heights

Items	Mark	Contents	Length (m)			
			LE2	LE1	LZ2 (4/5/6HP)	LZ2 (8/10P)
Allowable piping length	L1	Max. piping length	≤150	≤150	≤90	≤100
	ΔL (L2 – L4)	Difference between max. length and min. length from the 1st distribution joint	≤50	≤50	≤50	≤50
	LM	Max. length of main piping (at maximum size) *Even after 1st distribution joint, LM is allowed if at maximum piping length.	—	—	—	—
	ø1, ø2~ ø7	Max. length of each distribution pipe	≤50	≤50	≤50	≤50
	L1+ø1+ø2~ ø6 + LF + LG + LH	Total max. piping length including length of each distribution pipe (only liquid piping)	≤180	≤300	≤180	≤300
Allowable elevation difference	H1	When outdoor unit is installed higher than indoor unit	≤50	≤50	≤50	≤50
	H2	When outdoor unit is installed lower than indoor unit	≤40	≤40	≤40	≤40
Allowable length of joint piping	L3	T-joint piping (field-supply); Max. piping length between the first T-joint and solidly welded-shut end point	≤2	≤2	≤2	≤2

L = Length, H = Height

Piping Size

Main Piping Size (LA) LE1/LE2/LZ2 series

Outdoor units	12.1 kW (4HP)	14.0 kW (5HP)	15.5 kW (6HP)	22.4 kW (8HP)	25.0/28.0 kW (10HP)
Gas piping mm (inches)	ø15.88 (ø5/8)			ø19.05 (ø3/4)	
	Flare connection			Brazing connection	
Liquid piping mm (inches)	ø9.52 (ø3/8)				
	Flare connection				

Note :If future extension is planned, select the piping diameter based on the total horsepower after extension.

Indoor Unit Piping Connection (ø1,ø2...ø13)

LE1/LE2 series

Indoor unite type	22	28	36	45	56	60	71/73	90	106	140	160	180	224	280	
Gas tubing mm (inches)	ø12.7 (ø1/2)					ø15.88 (ø5/8)				ø19.05 (ø3/4)		ø22.22 (ø7/8)			
Liquid tubing mm (inches)	ø6.35 (ø1/4)					ø9.52 (ø3/8)									

LZ2 series

Indoor unite type	22	28	36	45	56	60	71/73	90	106	140	160	
Gas piping mm (inches)	ø12.7 (ø1/2)								ø15.88 (ø5/8)			
Liquid piping mm (inches)	ø6.35 (ø1/4)								ø9.52 (ø3/8)			

Main Piping Size After Distribution (LB, LC...) LE1/LE2/LZ2 series

Total capacity after distribution	Below kW	7.1 (2.5HP)	16.0 (6 HP)	22.5 (8.1 HP)	—	
	Over kW	—	7.1 (2.5 HP)	16.0 (6 HP)	22.5 (8.1 HP)	
Piping size	Gas piping	(mm)	ø12.7	ø15.88	ø19.05	ø22.22
		(inches)	ø1/2	ø5/8	ø3/4	ø7/8
	Liquid piping	(mm)	ø9.52	ø9.52	ø9.52	ø9.52
		(inches)	ø3/8	ø3/8	ø3/8	ø3/8

kw = kilowatts
 Note :In case the total capacity of connected indoor units exceeds the total capacity of the outdoor units, select the main piping size for the total capacity of the outdoor units.

System Limitations

LE1/LE2 series

Outdoor units	12.1 kW (4HP)	14.0 kW (5HP)	15.5 kW (6HP)	22.4 kW (8 HP)	25.0 kW (10 HP)
Number of max. connectable indoor units	7	8	9	13	13
Max. allowable indoor/outdoor capacity ratio	50 – 130%			50 – 130%	

LZ2 series

Outdoor units	12.1 kW (4HP)	14.0 kW (5HP)	15.5 kW (6HP)	22.4 kW (8 HP)	28.0 kW (10 HP)
Number of max. connectable indoor units	7	8	9	15	16
Max. allowable indoor/outdoor capacity ratio	50 – 150%				20 – 150%

24-hour nanoe™ X Air Purification*

While the general filters in air purifiers are effective against airborne bacteria and viruses, nanoe™ X also actively works to inhibit longer-living, adhered bacteria and viruses.

As well as this, the Panasonic Comfort Cloud and WLAN smart adaptor (CZ-CAPWFC1) gives you access to your air conditioner anywhere, anytime, so you can turn nanoe™ X on even while you're out and enjoy 24-hour quality air.



*Unit must be constantly turned on and operating in the air purification mode - nanoe™ X.
** <https://www.businessinsider.com/coronavirus-lifespan-on-surfaces-graphic-2020-3>



nanoe™ X device evolution

Evolved Discharge System → Dramatically Increased Release of Hydroxyl Radicals
Higher Concentration of nanoe™ X in the Space → Faster nanoe™ X Effects

	nanoe™	nanoe™ X Generator Mark 1	nanoe™ X Generator Mark 2	nanoe™ X Generator Mark 3	Differences in discharge systems Changed from 4-point discharge to circular discharge
Hydroxyl radicals	0.48 Trillion* hydroxyl radicals/sec	4.8 Trillion* hydroxyl radicals/sec	9.6 Trillion* hydroxyl radicals/sec	48 Trillion* hydroxyl radicals/sec	
Device status		Electrostatic atomisation Multi-leader discharge	Electrostatic atomisation Multi-leader discharge	Electrostatic atomisation Circular discharge	

* Measured using the ESR method (amount of hydroxyl radicals immediately after release from the generator). (Source: Panasonic internal research)

nanoe™ X technology inhibits virus

Our nanoe™ X technology has shown to suppress the activity of viruses & bacteria. Enjoy cleaner and quality air at home. Stay safer indoors with nanoe™ X.

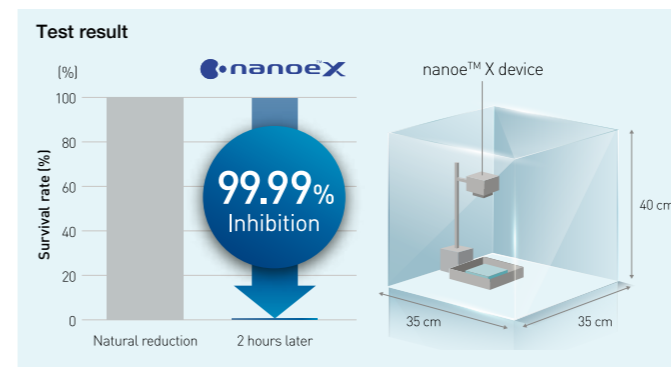

Overview
The objective of this test was to determine if nanoe™ X inhibit the activity of the virus. Gauze saturated with virus solution was exposed to a generator of nanoe™ X from a distance of 15 cm in a 45-liter box for 2 hours. Over 99.99%* of the activity of the virus was inhibited.

Device type: 10 x nanoe™ X (Mark 1)
Test Institute: TEXCELL (France) Test duration: 2 hours

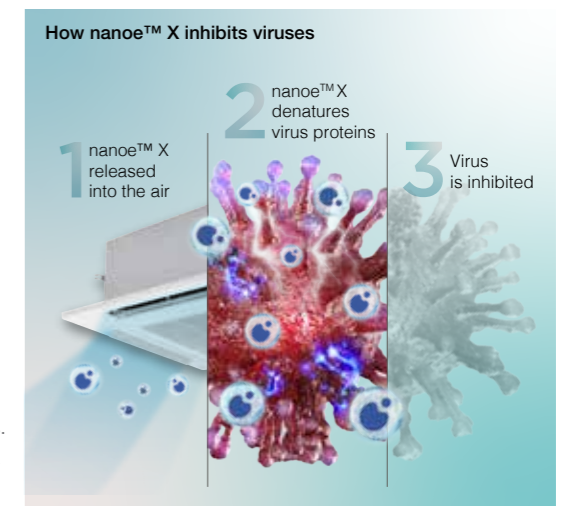

Notes: 1) The virus infectious titer was measured and used to calculate the inhibition rate. 2) This verification was designed to generate basic research data on the effects of nanoe™ X on the virus in laboratory conditions. It was not designed to evaluate product performance.

24-hour nanoe™ X air Purification, anywhere, anytime

Actively purifies your air and inhibits pollutants all day long

Get 24 hr Quality Air for you and your loved ones by turning nanoe™ X on using Panasonic Comfort Cloud even when you're out. nanoe™ X functions in both cooling and heating modes and is maintenance-free, helping you keep your costs down with cleaner air.

- nanoe™ X functions in cooling as well as fan mode after business hours.
- Cleans indoor air even when the space is not in use.
- No need to consume excessive electricity to clean the air.



Please refer to the nanoe™ X website.

24-hour Purification

Only at 15W*/Hour
Low energy consumption with fan mode 15W* per hour for a single unit.

nanoe ON, Cooling ON (Cooling Mode) | nanoe ON, Cooling OFF (Fan Mode)

nanoe™ X cleans indoor air while maintaining a comfortable temperature when people are present.

After business hours, nanoe™ X keeps cleaning indoor air in fan mode.

*In case of using 2.2 kW-7.3 kW 4 way cassette models with fan tap L, flap position 5, standard panel. Energy consumption may vary depending on models.

nanoe™ X Mark 3 achieves virus inhibition in a larger space in a shorter time

Mark 3 (100 x) Device: 4-Way Cassette Large-Space Test for Adherent Virus (Bacteriophage)
In a large space of 139 m³ (56 m²), a 98.81% inhibition rate was achieved in 4 hours.

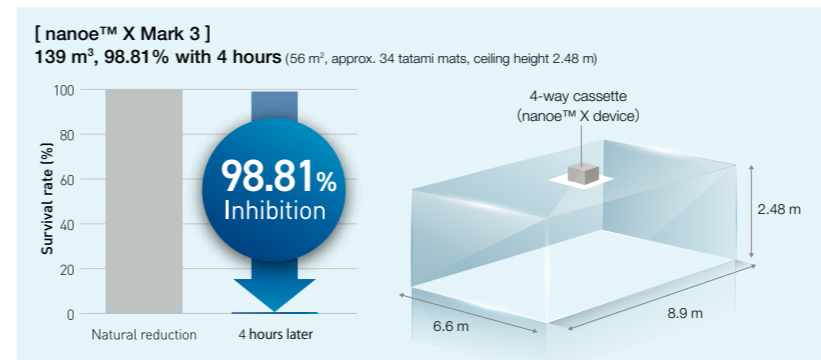

Please refer to the nanoe™ X website for the Mark 3 information.

Device type: nanoe™ X Generator Mark 3
Subject: Adhesive virus (coliphage)
Indoor unit: 4-way cassette
Test Institute: SGS Inc
Test duration: 4 hours
Report No.: SHES210901902584

Smart Comfort with CONEX

CONEX goes beyond simple remote control to combine sophistication with simplicity, offering IoT integration that connects directly to a variety of apps for next-generation solutions.

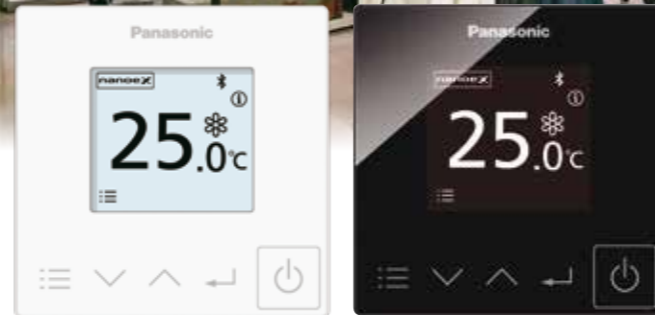

CONEX
(CZ-RTC6WBL / CZ-RTC6BL)

Simple and sophisticated design in-and-out

User friendly interface with stylish design measuring just 86 x 86 mm, CONEX is an extremely compact remote controller which perfectly matches with all kinds of modern building.

Easy control and access for end users and installers with just one remote

User-friendly day day-to-day operation for end users and simplified set up for installers.



A next-generation remote control solution optimised for usability

H&C Control App
End user > Installer

- Easy setting of timers and scheduling as well as monitoring power consumption.
- Fine tune the equipment to the environment.



Scan QR code to download free Panasonic H&C Control App



True-comfort for end user and installer – H&C Control App

H&C Control App makes complex initial set-up visually touch and feel easy and respond swiftly to clients' requests via Bluetooth using a smartphone or tablet.



Advantages

Comfort day-to day operations

It's now simpler than ever for end users to further customize settings to meet their needs and perform operations including basic settings.

Intuitive operation for easy configuration

Simplifies initial controller configuration as well as access to comprehensive settings including weekly timers and maintenance.

Straightforward suggestions to clients

Share a single screen with your customer and together tailor everything to meet their needs, from basic setup to weekly timers, all in real time.

Quicker configuration for multiple controllers

Save time and copy templates for weekly timers and settings to multiple remote controllers.



Indoor Units

Wide choice of models depending on the indoor requirements

Key Indoor Units Equipped DC motors



Compatible with a large range of indoor units and controls

An expansion of Panasonic VRF line up, the Mini compatible with a large range of indoor units and can utilize all Panasonic's scalable control and monitoring solutions.

Wide range of indoor units, either supporting Panasonic's optional R32 refrigerant leak detector alarm or having built-in detectors provide a great flexibility for all types of installation.

LZ2 series are fully compatible with all control and connectivity solutions from Panasonic. With a wide range of individual controllers, hotel room controllers, optional wireless adapters, VRF Smart Connectivity+, and Panasonic AC Smart Cloud compatibility.

	4 Way Cassette		Connects to R32 Panasonic sensor
	4 Way Mini Cassette		Connects to R32 Panasonic sensor
	Mid Static Adaptive Ducted		Built-in R32 sensors
	Wall-mounted		Connects to R32 Panasonic sensor
	Slim LowStatic Ducted		Connects to R32 Panasonic sensor

Panasonic R32 refrigerant leak detector/ alarm (optional)

For compatible indoor unit models, Panasonic offers its optional external R32 refrigerant leak detector (CZ-CGLSC1). This enables the customer to decide if a Panasonic R32 refrigerant leak detector is required to comply with the restrictions, or if the indoor unit may be safely installed in this room without it. This optional leakage detection sensor has an integrated alarm buzzer and can output a signal to a central alarm system in the building. The device is connected to the remote control terminals of the indoor unit and can be used in combination with any of the Panasonic VRF remote controllers, either wired or wireless.

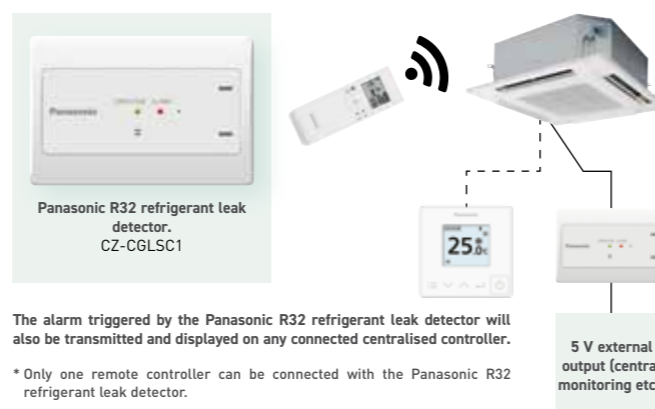

High-spec Wired Remote Controller

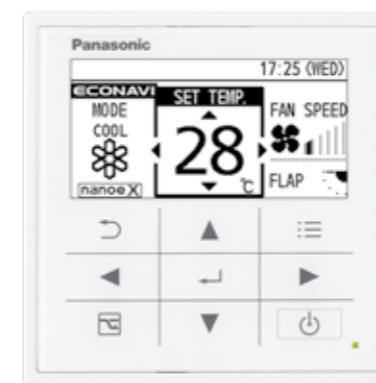

CZ-RTC5B

Large 3.5" full-dot LCD with white LED backlight

Characters and icons are clearly displayed for improved visibility. The display is also large enough to provide a wide range of information for easy confirmation of operation conditions.



Stylish, easy-to-use touch key design

The elegant, flat design features large touch keys in a simple layout enabling easy, intuitive operation.



All Ducted Series

Discharge air temperature control

Smart sensors control discharge air temperature for precise room temperature control. Possible to reduce cold drafts during heating operation.

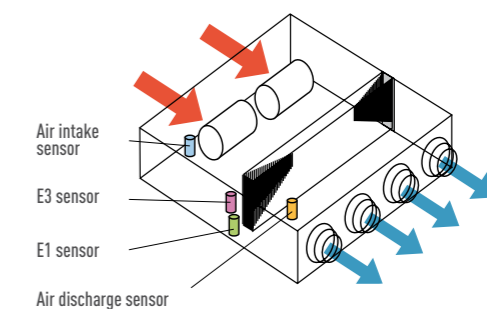

Wall Mounted / K2 (22~36), K2 (45~106) type



Compact design with flat surface enables seamless match with any type of room interior

Noise reducing external valve kit

To reduce noise level of expansion valve. (Optional accessory)



CZ-P56SVK2 (for 22 - 56 type)
CZ-P160SVK2 (for 73* - 106 type)

*When the pipe diameter is (Liquid) Ø6.35 - (Gas) Ø12.7, please use CZ-P56SVK2.

Indoor Units Range

Class	22	28	36	45	56	60	73	90
Capacity	2.2/2.5 7,500/8,500	2.8/3.2 9,600/10,900	3.6/4.2 12,300/14,300	4.5/5.0 15,400/17,100	5.6/6.3 19,100/21,500	6.0/7.1 20,500/24,200	7.3/8.0 24,900/27,300	9.0/10.0 30,700/34,100
Type	2.2/2.5 7,500/8,500	2.8/3.2 9,600/10,900	3.6/4.2 12,300/14,300	4.5/5.0 15,400/17,100	5.6/6.3 19,100/21,500	6.0/7.1 20,500/24,200	7.3/8.0 24,900/27,300	9.0/10.0 30,700/34,100
nanoeX Generator Mark3 F3 type Mid Static Adaptive Ducted R410A	NEW // S-22MF3E5AN	NEW // S-28MF3E5AN	NEW // S-36MF3E5AN	NEW // S-45MF3E5AN	NEW // S-56MF3E5AN	NEW // S-60MF3E5AN	NEW // S-73MF3E5AN	NEW // S-90MF3E5AN
nanoeX Generator Mark3 F3 type Mid Static Adaptive Ducted R32	NEW // S-22MF3E5BN	NEW // S-28MF3E5BN	NEW // S-36MF3E5BN	NEW // S-45MF3E5BN	NEW // S-56MF3E5BN	NEW // S-60MF3E5BN	NEW // S-73MF3E5BN	NEW // S-90MF3E5BN
M1 type Slim Low Static Ducted R410A/R32	 S-22MM1E5B	 S-28MM1E5B	 S-36MM1E5B	 S-45MM1E5B	 S-56MM1E5B			
Z1 type Slim & Narrow Ducted R410A	 S-22MZ1H4A	 S-28MZ1H4A	 S-36MZ1H4A	 S-45MZ1H4A	 S-56MZ1H4A	 S-60MZ1H4A	 S-73MZ1H4A	
E2 type High Static Ducted / Energy Saving High- Fresh Air Ducted R410A								 S-180ME2E5*
E1 type High Static Ducted R410A								 S-90ME1R5A
K2 type Wall Mounted R410A/R32	 S-22MK2E5B	 S-28MK2E5B	 S-36MK2E5B	 S-45MK2E5B	 S-56MK2E5B		 S-73MK2E5B	
nanoeX Generator Mark3 U2 type 4-Way Cassette Panel No. CZ-KPU3H R410A/R32	NEW // S-22MU2E5BN	NEW // S-28MU2E5BN	NEW // S-36MU2E5BN	NEW // S-45MU2E5BN	NEW // S-56MU2E5BN	NEW // S-60MU2E5BN	NEW // S-73MU2E5BN	NEW // S-90MU2E5BN
nanoeX Generator Mark3 Y3 type 4-Way Mini Cassette Panel No. CZ-KPY4 R410A/R32	 S-22MY3E	 S-28MY3E	 S-36MY3E	 S-45MY3E	 S-56MY3E			
L1 type 2-Way Cassette Panel No. CZ-02KPL2 Panel No. CZ-03KPL2 (Only for S-73ML1E5) R410A	 S-22ML1E5	 S-28ML1E5	 S-36ML1E5	 S-45ML1E5	 S-56ML1E5		 S-73ML1E5	
D1 type 1-Way Cassette Panel No. CZ-KPD2 R410A		 S-28MD1E5	 S-36MD1E5	 S-45MD1E5	 S-56MD1E5		 S-73MD1E5	
T2 type Under Ceiling R410A			 S-36MT2E5A	 S-45MT2E5A	 S-56MT2E5A		 S-73MT2E5A	
nanoeX Generator Mark1 G1 type Floor Console R410A	 S-22MG1E5N	 S-28MG1E5N	 S-36MG1E5N	 S-45MG1E5N	 S-56MG1E5N			
P1 type Floor Standing R410A	 S-22MP1E5	 S-28MP1E5	 S-36MP1E5	 S-45MP1E5	 S-56MP1E5		 S-71MP1E5	
R1 type Concealed Floor Standing R410A	 S-22MR1E5	 S-28MR1E5	 S-36MR1E5	 S-45MR1E5	 S-56MR1E5		 S-71MR1E5	

* High fresh air system is not allowed for 18 kW model.

106	112	140	160	180	224	280	Functions
Cooling/Heating	Cooling/Heating	Cooling/Heating	Cooling/Heating	Cooling/Heating	Cooling/Heating	Cooling/Heating	
10.6/11.4 36,200/38,900	11.2/12.5 38,200/42,700	14.0/16.0 47,800/54,600	16.0/18.0 54,600/61,400	18.0/20.0 61,400/68,200	22.4/25.0 76,400/85,300	28.0/31.5 95,500/107,500	
	NEW // S-112MF3E5AN	NEW // S-140MF3E5AN	NEW // S-160MF3E5AN				self-diagnosis Auto fan DRY Dry mode Auto restart DP Drain pump DC motor
	NEW // S-112MF3E5BN	NEW // S-140MF3E5BN	NEW // S-160MF3E5BN				self-diagnosis Auto fan DRY Dry mode Auto restart DP Drain pump DC motor
							self-diagnosis Auto fan DRY Dry mode Auto restart DP Drain pump DC motor
							self-diagnosis Auto fan DRY Dry mode Auto restart DC motor
				 S-180ME2E5*	High Fresh Air S-224ME2E5	High Fresh Air S-280ME2E5	self-diagnosis Auto fan DRY Dry mode Auto restart DC motor
	 S-112ME1R5A	 S-140ME1R5A	 S-160ME1R5A				self-diagnosis Auto fan DRY Dry mode Auto restart
 S-106MK2E5B							self-diagnosis Auto fan DRY Dry mode Auto restart Air swing DC motor
	NEW // S-112MU2E5BN	NEW // S-140MU2E5BN	NEW // S-160MU2E5BN				self-diagnosis Auto fan DRY Dry mode Auto restart Air swing DP Drain pump DC motor
							self-diagnosis Auto fan DRY Dry mode Auto restart Air swing DP Drain pump DC motor
							self-diagnosis Auto fan DRY Dry mode Auto restart Air swing DP Drain pump
							self-diagnosis Auto fan DRY Dry mode Auto restart Air swing DP Drain pump DC motor
 S-106MT2E5A		 S-140MT2E5A					self-diagnosis Auto fan DRY Dry mode Auto restart Air swing DC motor
							self-diagnosis Auto fan DRY Dry mode Auto restart Air swing DC motor
							self-diagnosis Auto fan DRY Dry mode Auto restart
							self-diagnosis Auto fan DRY Dry mode Auto restart

F3 TYPE Mid Static Adaptive Ducted

Control all aspects of your environment with exceptional performance and quiet operation. Vertical installation flexibility offers the perfect solution when ceiling heights are restricted.

NEW	S-22MF3E5AN / S-28MF3E5AN / S-36MF3E5AN / S-45MF3E5AN / S-56MF3E5AN	R410A
NEW	S-22MF3E5BN / S-28MF3E5BN / S-36MF3E5BN / S-45MF3E5BN / S-56MF3E5BN	R32
	S-60MF3E5AN / S-73MF3E5AN / S-90MF3E5AN	
	S-60MF3E5BN / S-73MF3E5BN / S-90MF3E5BN	

nanoe™ X Generator Mark3

S-112MF3E5AN / S-140MF3E5AN / S-160MF3E5AN

R410A

S-112MF3E5BN / S-140MF3E5BN / S-160MF3E5BN

R32

- DC motor
- Self-diagnosis Function
- Automatic Fan Operation
- Automatic Restart Function
- DRY Dry mode
- DP Built-in Drain Pump

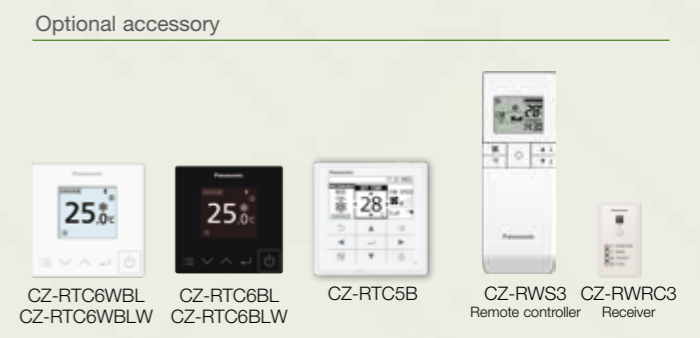

Technical focus

- 4 installation possibilities with horizontal and vertical mounting and selectable rear or bottom air inlet
- Space saving 250mm height
- DC fan motor for variable external static pressure control
- Industry-leading horizontal/vertical design
- Powerful 150Pa static pressure in a compact unit.
- Leading-class low sound levels from 20 dB(A)
- Improved drain pan suitable for both horizontal / vertical installation
- nanoe™ X : 100x for CAC (100 times more nanoe™ particle for wide commercial space)
- Accurate temperature control to reduce cold drafts during operation

Variable external static pressure control

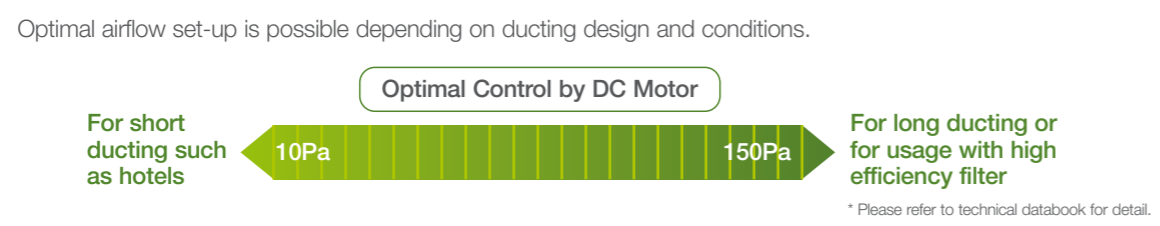

Powerful 150Pa external static pressure in an industry-leading horizontal/vertical installation design

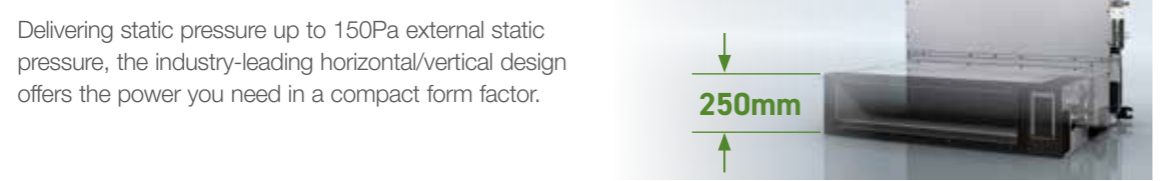

Improved drain pan design

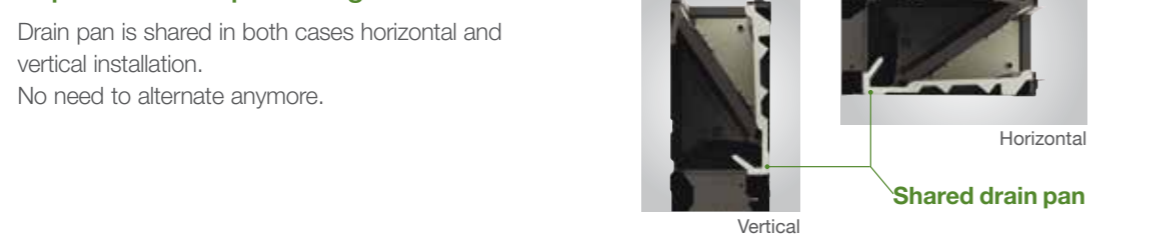

Superior Air Quality

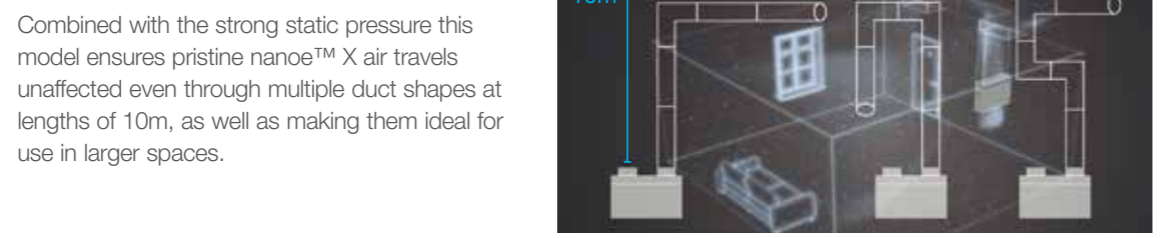

As the experiments demonstrate, even with a total ductwork length of up to 10m, effectiveness of nanoe™ X is maintained.

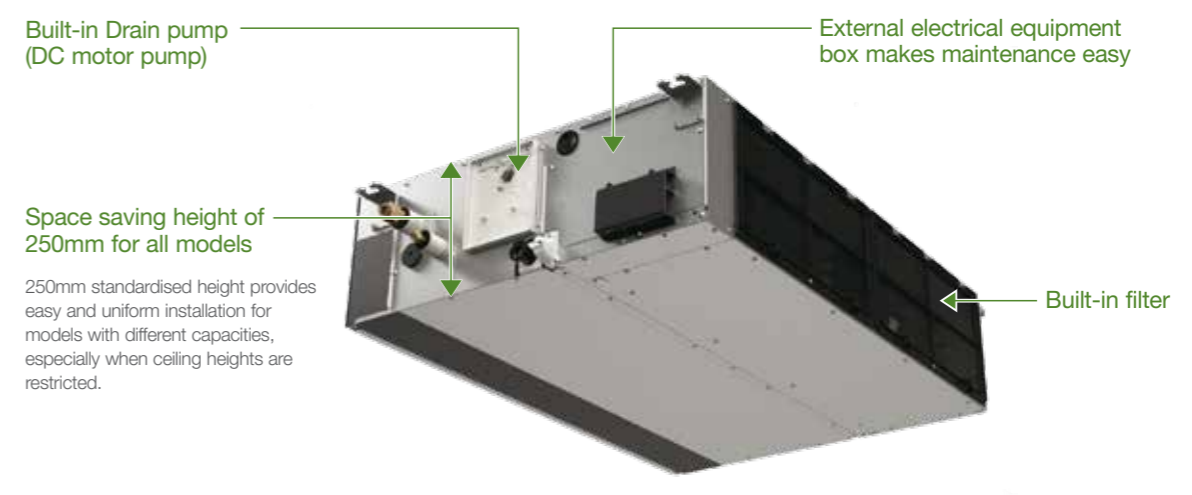

Discharge air temperature control

- Possible to control discharge air temperature for accurate room temperature control.
 - Possible to reduce cold drafts during heating operation.
- Note: Before spec-in, please consult with an authorised Panasonic dealer.
-
- Air intake sensor
- E3 sensor
- E1 sensor
- Air discharge sensor

Selectable air inlet position



System example



More powerful drain pump

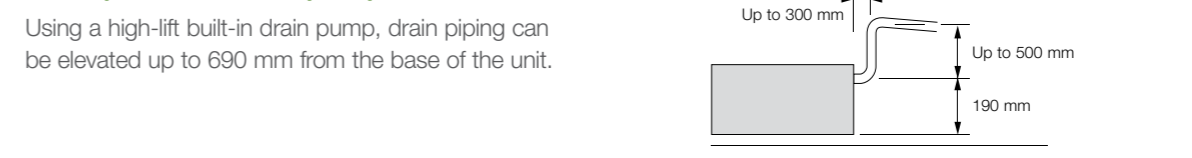

F3 TYPE Mid Static Adaptive Ducted

Model Name	R410A	S-22MF3E5AN	S-28MF3E5AN	S-36MF3E5AN	S-45MF3E5AN	S-56MF3E5AN	
	R32	S-22MF3E5BN	S-28MF3E5BN	S-36MF3E5BN	S-45MF3E5BN	S-56MF3E5BN	
Power source	220/230/240 V, 1 phase - 50/60 Hz						
Cooling capacity	kW	2.2	2.8	3.6	4.5	5.6	
	BTU/h	7,500	9,600	12,300	15,400	19,100	
Heating capacity	kW	2.5	3.2	4.2	5.0	6.3	
	BTU/h	8,500	10,900	14,300	17,100	21,500	
Power input	Cooling kW	0.06/0.06/0.06	0.06/0.06/0.06	0.06/0.06/0.06	0.06/0.06/0.06	0.089/0.089/0.089	
	Heating kW	0.06/0.06/0.06	0.06/0.06/0.06	0.06/0.06/0.06	0.06/0.06/0.06	0.089/0.089/0.089	
Running amperes	Cooling A	0.46/0.45/0.44	0.46/0.45/0.44	0.46/0.45/0.44	0.46/0.45/0.44	0.65/0.63/0.61	
	Heating A	0.46/0.45/0.44	0.46/0.45/0.44	0.46/0.45/0.44	0.46/0.45/0.44	0.65/0.63/0.61	
Fan motor	Type	Sirocco fan					
	Air flow rate (H/M/L)	m ³ /h	768/660/480	768/660/480	840/720/480	840/720/480	960/840/600
		L/s	213/183/133	213/183/133	233/200/133	233/200/133	267/233/167
		Output kW	0.107	0.107	0.107	0.107	0.107
		External static pressure Pa	30 (10-150)	30 (10-150)	30 (10-150)	30 (10-150)	30 (10-150)
Sound power level (H/M/L)	dB	54/51/43	54/51/43	54/51/43	54/51/43	58/55/47	
Sound pressure sound (H/M/L)	dB(A)	31/28/20	31/28/20	31/28/20	31/28/20	35/32/24	
Dimensions	H x W x D	mm	250 x 800 x 730	250 x 800 x 730	250 x 800 x 730	250 x 800 x 730	
	Liquid	mm (inches)	Ø6.35 (Ø1/4)	Ø6.35 (Ø1/4)	Ø6.35 (Ø1/4)	Ø6.35 (Ø1/4)	
Pipe connections	Gas	mm (inches)	Ø12.7 (Ø1/2)	Ø12.7 (Ø1/2)	Ø12.7 (Ø1/2)	Ø12.7 (Ø1/2)	
	Drain piping		VP-20	VP-20	VP-20	VP-20	
Net weight	kg	26	26	26	26	26	

GLOBAL REMARKS	Rated conditions:	
	Cooling	Heating
	Indoor air temperature	27°C DB / 19°C WB
Outdoor air temperature	35°C DB / 24°C WB	7°C DB / 6°C WB

Specifications are subject to change without notice.



S-60MF3E5AN	S-73MF3E5AN	S-90MF3E5AN	S-112MF3E5AN	S-140MF3E5AN	S-160MF3E5AN
S-60MF3E5BN	S-73MF3E5BN	S-90MF3E5BN	S-112MF3E5BN	S-140MF3E5BN	S-160MF3E5BN
220/230/240 V, 1 phase - 50/60 Hz					
6.0	7.3	9.0	11.2	14.0	16.0
20,500	24,900	30,700	38,200	47,800	54,600
7.1	8.0	10.0	12.5	16.0	18.0
24,200	27,300	34,100	42,700	54,600	61,400
0.079/0.079/0.079	0.079/0.079/0.079	0.136/0.136/0.136	0.265/0.265/0.265	0.265/0.265/0.265	0.330/0.330/0.330
0.079/0.079/0.079	0.079/0.079/0.079	0.136/0.136/0.136	0.265/0.265/0.265	0.265/0.265/0.265	0.330/0.330/0.330
0.53/0.52/0.51	0.53/0.52/0.51	0.92/0.90/0.88	1.80/1.76/1.72	1.80/1.76/1.72	2.22/2.14/2.09
0.53/0.52/0.51	0.53/0.52/0.51	0.92/0.90/0.88	1.80/1.76/1.72	1.80/1.76/1.72	2.22/2.14/2.09
Sirocco fan	Sirocco fan	Sirocco fan	Sirocco fan	Sirocco fan	Sirocco fan
1,260/1,080/900	1,260/1,080/900	1,500/1,380/960	2,220/1,920/1,560	2,220/1,920/1,560	2,400/2,040/1,680
350/300/250	350/300/250	417/383/267	617/533/433	617/533/433	667/567/467
0.165	0.165	0.165	0.259	0.259	0.259
30 (10-150)	30 (10-150)	40 (10-150)	50 (10-150)	50 (10-150)	50 (10-150)
54/51/46	54/51/46	58/56/48	64/59/55	64/59/55	66/60/56
31/28/23	31/28/23	35/33/25	41/36/32	41/36/32	43/37/33
250 x 1,000 x 730	250 x 1,000 x 730	250 x 1,000 x 730	250 x 1,400 x 730	250 x 1,400 x 730	250 x 1,400 x 730
Ø6.35 (Ø1/4)	Ø6.35 (Ø1/4)	Ø6.35 (Ø1/4)	Ø9.52 (Ø3/8)	Ø9.52 (Ø3/8)	Ø9.52 (Ø3/8)
Ø12.7 (Ø1/2)	Ø12.7 (Ø1/2)	Ø12.7 (Ø1/2)	Ø15.88 (Ø5/8)	Ø15.88 (Ø5/8)	Ø15.88 (Ø5/8)
VP-20	VP-20	VP-20	VP-20	VP-20	VP-20
31	31	31	40	40	40

F3 TYPE MID STATIC DUCTED Dimensions

Type	A	B	C	D	E	F
	mm	mm	mm	mm	mm	Q'ty
22/28/36/45/56	867	800	450 (Pitch 150 × 3)	71	592	12
60/73/90	1,067	1,000	750 (Pitch 150 × 5)	21	792	16
112/140/160	1,467	1,400	1,050 (Pitch 150 × 7)	71	1,192	20

- ① Refrigerant tubing joint (liquid tube)
S-22/28/36/45/56MF3E5AN : Φ6.35 (flared)
S-60/73/90/112/140/160MF3E5AN : Φ9.52 (flared)
- ② Refrigerant tubing joint (gas tube)
S-22/28/36/45/56MF3E5AN : Φ12.7 (flared)
S-60/73/90/112/140/160MF3E5AN : Φ15.88 (flared)
- ③ Upper drain port VP20 (ø26 mm)
200 mm flexible hose supplied
- ④ Bottom drain port VP20 (ø26 mm)
- ⑤ Suspension lug (4 – 12 × 30 mm)
- ⑥ Power supply outlet
- ⑦ Fresh air intake port (ø100 mm)^{*1}
- ⑧ Flange for flexible air outlet duct
- ⑨ Electrical component box

*1 Necessary to attach duct connecting flange (field supply).

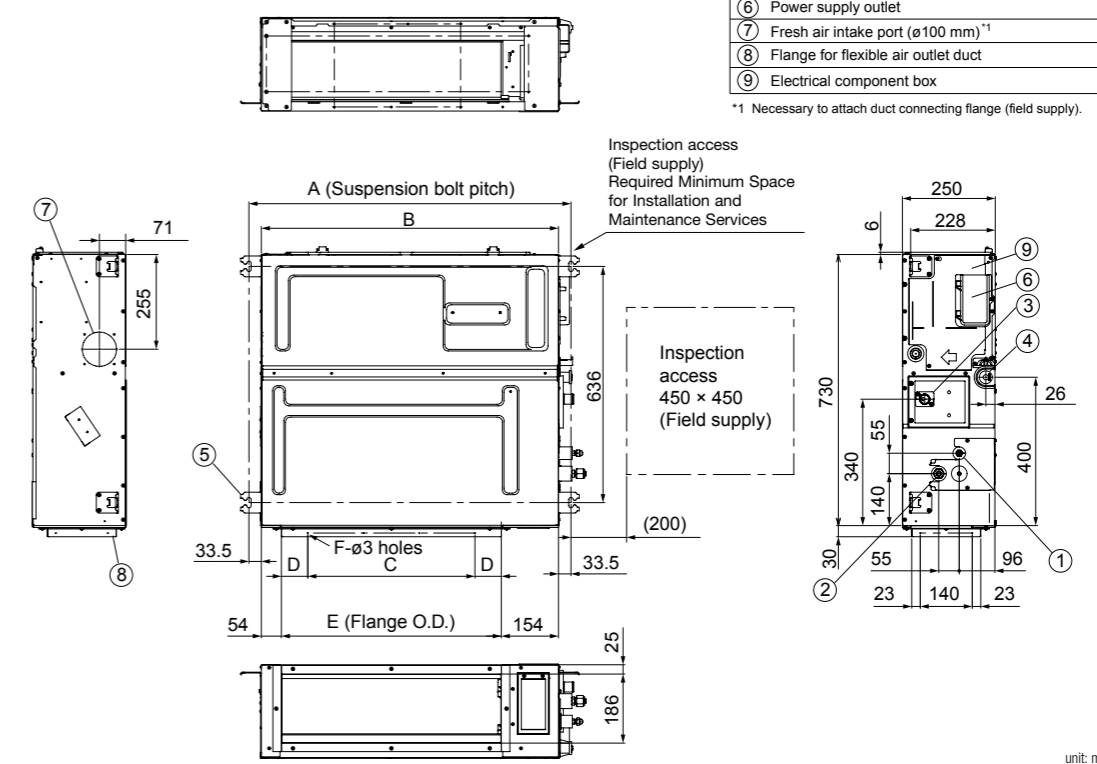

unit: mm

M1_{TYPE} Slim Low Static Ducted Concealed duct



The ultra slim M1 type is one of the leading products of its type in the industry. With a height of only 200 mm, it provides greater flexibility and adaptability for various applications. In addition, high efficiency and extreme low noise level make it highly suitable for hotels and small offices.



S-22MM1E5B / S-28MM1E5B / S-36MM1E5B
S-45MM1E5B / S-56MM1E5B

Optional accessory

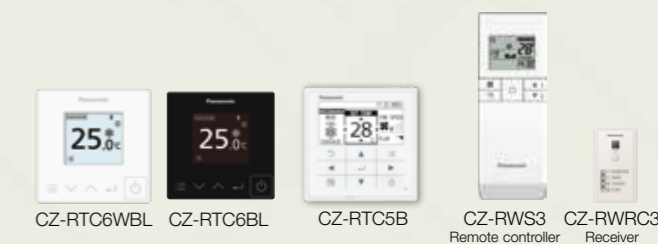

Self-diagnosis
Function



Automatic
Fan
Operation



Dry mode



Automatic
Restart
Function



Built-in Drain
Pump

Technical focus

- Ultra-slim profile: 200 mm for all models
- DC fan motor greatly reduces power consumption
- Ideal for hotel application with very narrow false ceilings
- Easy maintenance and service by external electrical box
- 40 Pa static pressure enables ductwork to be fitted.
- Includes drain pump
- Includes built in filter

Ultra-slim profile for all models

200mm height for all models allows installation in very narrow ceilings.



Drain pump with increased power!

Using the built-in high-lift drain pump, the drain piping rise height can be increased to 653 mm from the lower surface of the body.

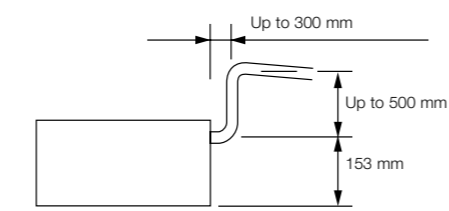

Model Name		S-22MM1E5B	S-28MM1E5B	S-36MM1E5B	S-45MM1E5B	S-56MM1E5B	
Power source		220/230/240 V, 1 phase - 50/60 Hz					
Cooling capacity	kW	2.2	2.8	3.6	4.5	5.6	
	BTU/h	7,500	9,600	12,300	15,400	19,100	
Heating capacity	kW	2.5	3.2	4.2	5.0	6.3	
	BTU/h	8,500	10,900	14,300	17,100	21,500	
Power input	Cooling kW	0.036/0.036/0.036	0.040/0.040/0.040	0.042/0.042/0.042	0.049/0.049/0.049	0.064/0.064/0.064	
	Heating kW	0.026/0.026/0.026	0.030/0.030/0.030	0.032/0.032/0.032	0.039/0.039/0.039	0.054/0.054/0.054	
Running current	Cooling A	0.26/0.26/0.26	0.30/0.30/0.30	0.31/0.31/0.31	0.37/0.37/0.37	0.48/0.48/0.48	
	Heating A	0.23/0.23/0.23	0.27/0.27/0.27	0.28/0.28/0.28	0.34/0.34/0.34	0.45/0.45/0.45	
Fan	Type	Sirocco fan	Sirocco fan	Sirocco fan	Sirocco fan	Sirocco fan	
	Air flow rate (H/M/L)	m ³ /h	480/420/360	510/450/390	540/480/420	630/570/480	750/690/600
		L/s	133/117/100	142/125/108	150/133/117	175/158/133	208/192/167
	Motor output	kW	0.06	0.06	0.06	0.06	0.06
	External static pressure	Pa	10 (30)	15 (30)	15 (40)	15 (40)	15 (40)
Sound power level (H/M/L)	dB	43/42/40	45/44/42	47/45/43	49/47/45	52/50/48	
Sound pressure level (H/M/L)	dB(A)	28/27/25 (30/29/27)*	30/29/27 (32/31/29)*	32/30/28 (34/32/30)*	34/32/30 (36/34/32)*	35/33/31 (37/35/32)*	
Dimensions	H x W x D	mm	200 x 750 x 640	200 x 750 x 640	200 x 750 x 640	200 x 750 x 640	
	Liquid	mm (inches)	Ø6.35 (Ø1/4)	Ø6.35 (Ø1/4)	Ø6.35 (Ø1/4)	Ø6.35 (Ø1/4)	
Pipe connections	Gas	mm (inches)	Ø12.7 (Ø1/2)	Ø12.7 (Ø1/2)	Ø12.7 (Ø1/2)	Ø12.7 (Ø1/2)	
	Drain piping		VP-20	VP-20	VP-20	VP-20	
Net weight	kg	19	19	19	19	19	

GLOBAL REMARKS	Rated conditions:	Cooling	Heating
	Indoor air temperature	27°C DB / 19°C WB	20°C DB
	Outdoor air temperature	35°C DB / 24°C WB	7°C DB / 6°C WB

Specifications are subject to change without notice.

* With booster cable.

M1 TYPE SLIM LOW STATIC DUCTED Dimensions

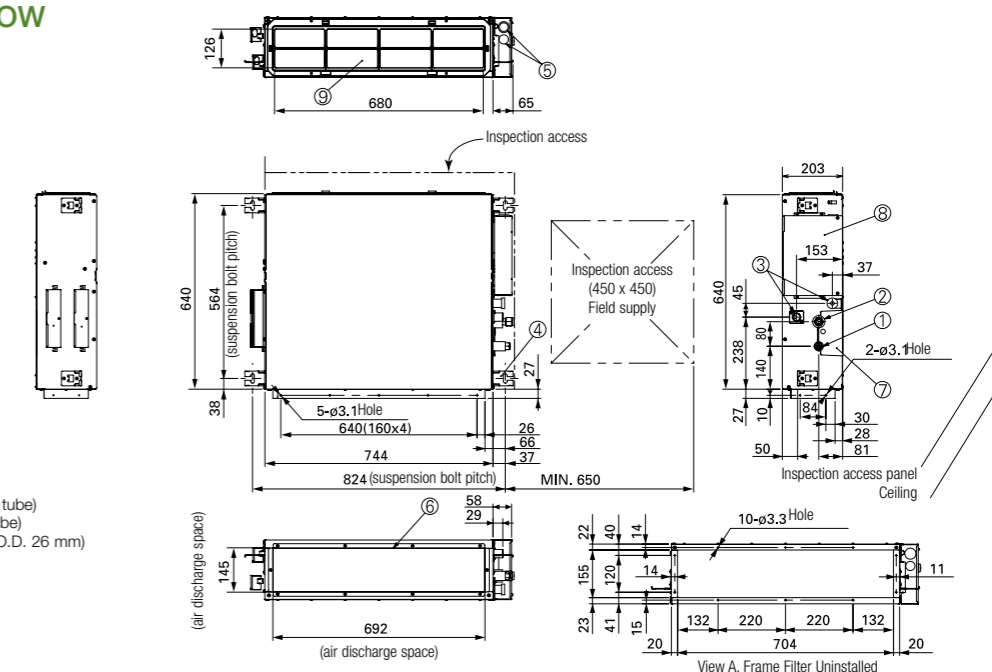

unit: mm

Z1 TYPE Slim & Narrow Ducted Concealed duct



The ultra slim Z1 type is one of the leading products of its type in the industry. With a height of only 200 mm, it provides greater flexibility and adaptability for various applications. In addition, high efficiency and extreme low noise level make it highly suitable for hotels and small offices.



Optional accessory

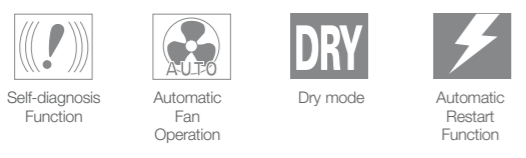

Technical focus

- Ultra-slim profile: 200 mm for all models
- DC fan motor greatly reduces power consumption
- Ideal for hotel application with very narrow false ceilings
- Easy maintenance and service by external electrical box
- 29 Pa static pressure enables ductwork to be fitted.
- Drain pump (optional)

Ultra-slim profile for all models

200mm height for all models allows installation in very narrow ceilings.



Drain pump with increased power! (optional)

Using the optional high-lift drain pump, the drain piping rise height can be increased to 700 mm from the drain pipe port.



CZ-73DMZ1

Model Name		S-22MZ1H4A	S-28MZ1H4A	S-36MZ1H4A	S-45MZ1H4A	S-56MZ1H4A	S-60MZ1H4A	S-73MZ1H4A
Power source		220/230/240 V, 1 phase - 50/60 Hz						
Cooling capacity	kW	2.2	2.8	3.6	4.5	5.6	6.0	7.3
	BTU/h	7,500	9,500	12,200	15,300	19,100	20,500	24,900
Heating capacity	kW	2.5	3.2	4.2	5.1	6.4	7.1	8.0
	BTU/h	8,500	10,900	14,300	17,400	21,800	24,200	27,300
Power input	Cooling kW	0.075/0.075/0.075	0.080/0.080/0.080	0.085/0.085/0.085	0.095/0.095/0.095	0.100/0.100/0.100	0.100/0.100/0.100	0.125/0.125/0.125
	Heating kW	0.075/0.075/0.075	0.080/0.080/0.080	0.085/0.085/0.085	0.095/0.095/0.095	0.100/0.100/0.100	0.100/0.100/0.100	0.125/0.125/0.125
Running current	Cooling A	0.50/0.47/0.45	0.55/0.52/0.50	0.60/0.57/0.55	0.70/0.68/0.65	0.75/0.72/0.70	0.75/0.72/0.70	0.80/0.78/0.75
	Heating A	0.50/0.47/0.45	0.55/0.52/0.50	0.60/0.57/0.55	0.70/0.68/0.65	0.75/0.72/0.70	0.75/0.72/0.70	0.80/0.78/0.75
Fan	Type	Sirocco fan	Sirocco fan	Sirocco fan	Sirocco fan	Sirocco fan	Sirocco fan	Sirocco fan
	Air flow rate (H/M/L) m³/h	480/420/360	600/540/420	600/540/420	690/630/510	720/660/540	870/750/630	1,080/840/660
	L/s	133/117/100	167/150/117	167/150/117	192/175/142	200/183/150	242/208/175	300/233/183
	Motor output W	60	60	60	60	60	60	60
	External static pressure Pa	10-30	10-30	10-30	10-30	10-30	10-30	10-30
Sound power level (H/M/L) dB		50/49/47	52/51/49	54/52/50	56/54/52	57/55/53	60/57/55	62/60/58
Sound pressure level (H/M/L) dB(A)		28/27/25	30/29/27	32/30/28	34/32/30	35/33/31	38/35/33	40/38/36
Dimensions H x W x D mm		200x830x500	200x830x500	200x830x500	200x830x500	200x830x500	200x830x500	200x1,050x550
	Liquid mm (inches)	Ø6.35 (Ø1/4)	Ø6.35 (Ø1/4)	Ø6.35 (Ø1/4)	Ø6.35 (Ø1/4)	Ø6.35 (Ø1/4)	Ø9.52 (Ø3/8)	Ø9.52 (Ø3/8)
Pipe connections	Gas mm (inches)	Ø12.7 (Ø1/2)	Ø12.7 (Ø1/2)	Ø12.7 (Ø1/2)	Ø12.7 (Ø1/2)	Ø12.7 (Ø1/2)	Ø15.88 (Ø5/8)	Ø15.88 (Ø5/8)
	Drain piping	O.D. Ø20.5 mm / I.D. Ø15.5mm	O.D. Ø20.5 mm / I.D. Ø15.5mm	O.D. Ø20.5 mm / I.D. Ø15.5mm	O.D. Ø20.5 mm / I.D. Ø15.5mm	O.D. Ø20.5 mm / I.D. Ø15.5mm	O.D. Ø20.5 mm / I.D. Ø15.5mm	O.D. Ø20.5 mm / I.D. Ø15.5mm
Net weight kg		17	17	18	18	18	18	24

GLOBAL REMARKS	Rated conditions:	
	Cooling	Heating
	Indoor air temperature 27°C DB / 19°C WB	20°C DB
Outdoor air temperature 35°C DB / 24°C WB	7°C DB / 6°C WB	

Specifications are subject to change without notice.

Z1 TYPE SLIM LOW STATIC DUCTED TWENTY SERIES Dimensions

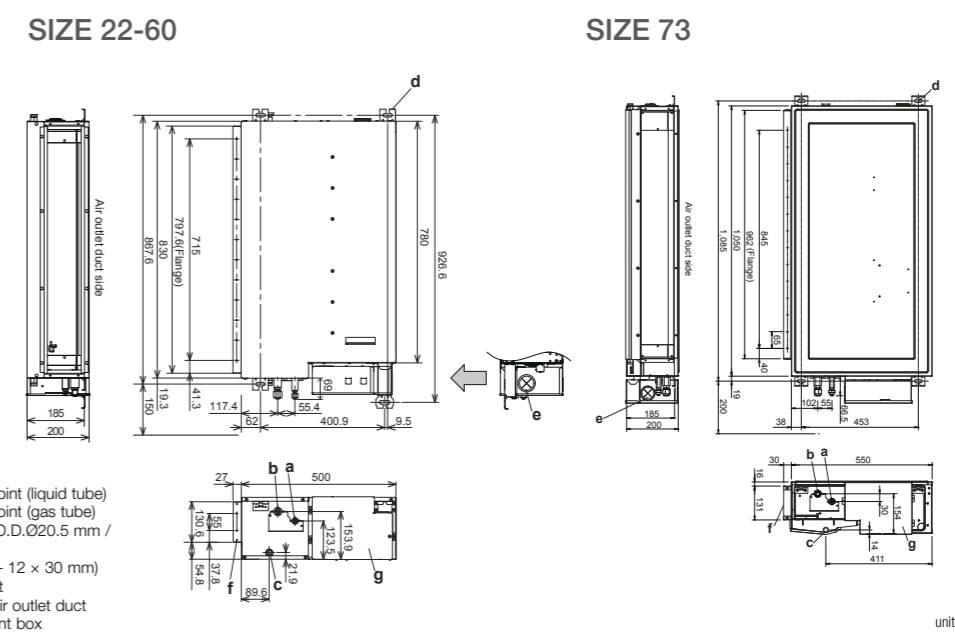

- a) Refrigerant tubing joint (liquid tube)
- b) Refrigerant tubing joint (gas tube)
- c) Bottom drain port O.D.Ø20.5 mm / I.D. Ø15.5mm
- d) Suspension lug (4 – 12 x 30 mm)
- e) Power supply outlet
- f) Flange for flexible air outlet duct
- g) Electrical component box

unit: mm

E2 TYPE High Static Ducted

Concealed duct / Air conditioning mode



High static and large airflow ducted for exceptional installation flexibility.



S-180ME2E5 / S-224ME2E5 / S-280ME2E5

Optional accessory



Self-diagnosis
Function



Automatic
Fan
Operation



Dry mode



Automatic
Restart
Function

Technical focus

- Design flexibility thanks to high static pressure and large air volume
- DC motor equipped
- Power input 45% less (compared to E1 type)
- Discharge air temperature control to reduce cold drafts during heating operation
- Configurable air temperature control
- Available Fresh Air Intake mode

3-step static pressure set up

You can select between the three Static Pressure modes of 270 Pa/140 Pa/60(72*) Pa for extra installation flexibility.



* 28 kW model

Max. 270 Pa static pressure setting

A maximum static pressure setting of a high 270 Pa enables the use of long ducts for installation in a wide range of spaces. Ideal for large-scale offices, restaurants and other facilities.

Sensible cooling 5-10% improved

New heat exchanger with ϕ 7mm pipe that increases the heat transfer surface to improve sensible cooling (5-10% improvement)

No Rap Valve Kit required

Thanks to improved performance, a Rap Valve Kit (CZ-P160RVK2) is no longer required.



Discharge air temperature control

- Equipped with 4 sensors (Intake/ Discharge)
- Able to control discharge air temperature for accurate room temperature control.
- Possible to reduce cold drafts during heating operation.

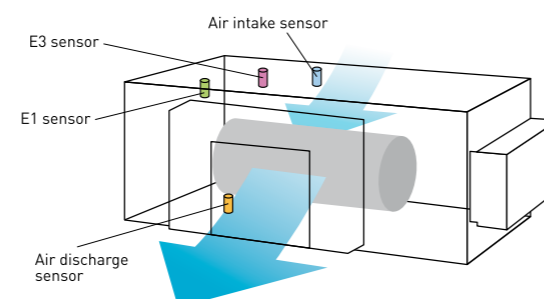

Model Name		S-180ME2E5	S-224ME2E5	S-280ME2E5	
Power source		220/230/240 V, 1 phase - 50 Hz, 220/230 V, 1 phase - 60 Hz			
Cooling capacity	kW	18.0	22.4	28.0	
	BTU/h	61,400	76,400	95,500	
Heating capacity	kW	20.0	25.0	31.5	
	BTU/h	68,200	85,300	107,500	
Power input	Cooling kW	0.400	0.440	0.715	
	Heating kW	0.400	0.440	0.715	
Running current	Cooling A	2.40/2.30/2.20	2.55/2.45/2.35	3.95/3.85/3.70	
	Heating A	2.40/2.30/2.20	2.55/2.45/2.35	3.95/3.85/3.70	
Fan	Type	Sirocco fan			
	Air flow rate (H/M/L)	m ³ /h	2,940/2,640/2,340	3,360/3,060/2,640	4,320/3,780/3,180
		L/s	817/733/650	933/850/733	1,200/1,050/883
	Motor output	kW	0.560 x 2		
	External static pressure	Pa	140 (60/270)		
Sound power level (H/M/L)	dB	76/74/72	77/75/73	81/79/75	
Sound pressure level (H/M/L)	dB(A)	44/42/40	45/43/41	49/47/43	
Dimensions	H x W x D	479 x 1,453 x 1,205			
	Liquid	inches (mm)	Ø9.52 (3/8)		
Pipe connections	Gas	inches (mm)	Ø19.05 (3/4)		
	Drain piping		VP-25		
Net weight	kg	102	102	106	

GLOBAL REMARKS	Rated conditions:	Cooling	Heating
	Indoor air temperature	27°C DB / 19°C WB	20°C DB
	Outdoor air temperature	35°C DB / 24°C WB	7°C DB / 6°C WB

E2 TYPE HIGH STATIC DUCTED Dimensions

- 1 Refrigerant piping (liquid pipes) Ø9.52
- 2 Refrigerant piping (gas pipes)
180 & 224 type: Ø19.05, 280 type: Ø22.22
- 3 Power supply outlet (Ø25 grommet, rubber)
- 4 Power supply outlet (spare) (Ø30 knock-out)
- 5 Optional outlet for piping
- 6 Drain port 25 A, male thread
- 7 Duct connection for suction
- 8 Duct connection for discharge

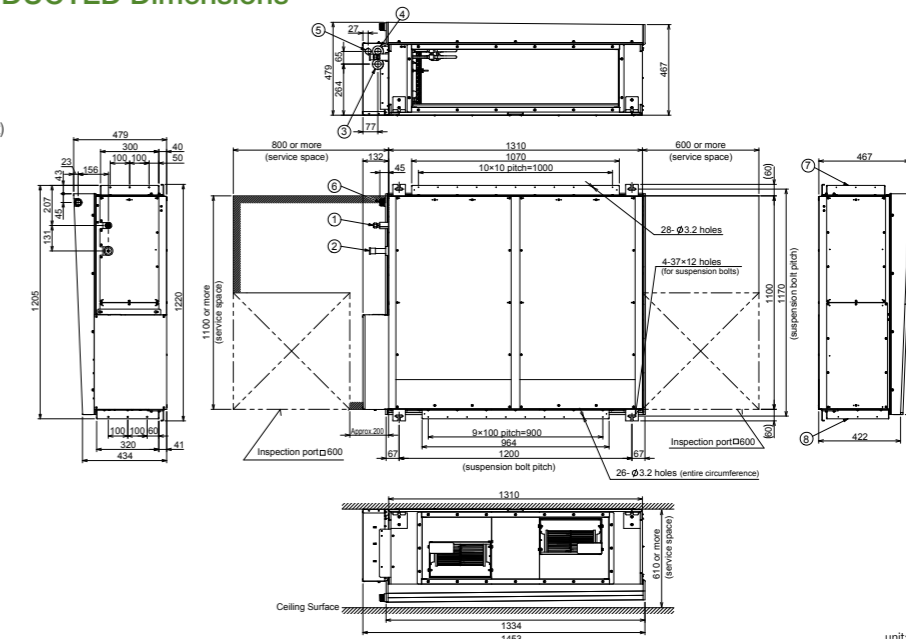

unit: mm

E2 TYPE Energy Saving High Fresh Air Ducted

Concealed duct high-static pressure



High static and large airflow ducted for exceptional installation flexibility.



S-224ME2E5 / S-280ME2E5

Optional accessory



Technical focus

- 100% fresh air intake for ventilation purpose
- Design flexibility with high static pressure and large air volume
- DC motor equipped
- Power input 45% less (compared to H1 type)
- Discharge air temperature control to reduce cold drafts during heating operation
- Configurable air temperature control

High Fresh System

High Fresh System enables delivery of fresh outside air at almost the same temperature and humidity as indoor air without putting a burden on air conditioning.
 * Capable of treating outdoor air only. Indoor air conditioner units are required to adjust indoor air temperature.

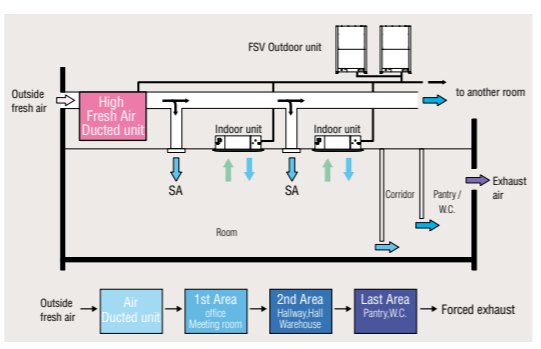

Mix operation unit with standard indoor units

- (1) The total rated capacity of indoor unit in fresh air intake mode (including the model "Fresh Air Intake Duct") should be used within 30% of outdoor unit rated capacity.
- (2) The total rated capacity of indoor unit in fresh air intake mode and other indoor unit should not exceed 100% of outdoor unit.

Discharge air temperature control

- Equipped with 4 sensors (Intake/ Discharge)
- Able to control discharge air temperature for accurate room temperature control.
- Possible to reduce cold drafts during heating operation.

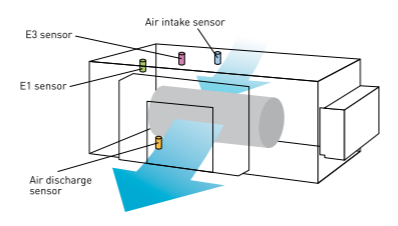

Remark For High Static Ducted Series

Model	Operation	Rap valve kit CZ-P160RVK2	3way control PCB CZ-CAPE2	3way valve kit CZ-P160HR3	Distribution Joint kit <2pipes> CZ-P160BK2 for 22.4kW unit or less CZ-P680BK2 for more than 22.4kW	Distribution Joint kit <3pipes> CZ-P224BH2 for 22.4kW unit CZ-P680BH2 for 28.0kW unit
E2 Type Energy Saving High-Fresh Air Ducted	Cooling Only	-	-	-	-	-
	Cool or Heat	2pcs	2pcs	-	2pcs	-
	Heat Recovery	-	2pcs	2pcs	1pc	1pc

Model Name		S-224ME2E5	S-280ME2E5
Power source		220/230/240 V, 1 phase - 50 Hz, 220/230 V, 1 phase - 60 Hz	
Cooling capacity	kW	22.4	28.0
	BTU/h	76,400	95,500
Heating capacity	kW	21.2	26.5
	BTU/h	72,300	90,400
Power input	Cooling kW	0.290	0.350
	Heating kW	0.290	0.350
Running current	Cooling A	1.90/1.85/1.80	2.30/2.20/2.10
	Heating A	1.90/1.85/1.80	2.30/2.20/2.10
Fan	Type	Sirocco fan	
	Air flow rate m³/h	1,700	2,100
	L/s	472	583
	Motor output kW	0.560 x 2	0.750 x 2
	External static pressure Pa	200	200
Sound power level	dB	75	76
Sound pressure level	dB(A)	43	44
Dimensions	H x W x D mm	479 x 1,453 x 1,205	
	Liquid inches (mm)	Ø9.52 (Ø3/8)	
Pipe connections	Gas inches (mm)	Ø19.05 (Ø3/4)	
	Drain piping	VP-25	
Net weight	kg	102	106

GLOBAL REMARKS	Rated conditions:	Cooling	Heating
	Outdoor air temperature	33°C DB / 28°C WB	0°C DB / -2.9°C WB

Specifications are subject to change without notice.

E2 TYPE HIGH STATIC DUCTED Dimensions

- 1 Refrigerant piping (liquid pipes) Ø9.52
- 2 Refrigerant piping (gas pipes) 224 type: Ø19.05, 280 type: Ø22.22
- 3 Power supply outlet (Ø25 grommet, rubber)
- 4 Power supply outlet (spare) (Ø30 knock-out)
- 5 Optional outlet for piping
- 6 Drain port 25 A, male thread
- 7 Duct connection for suction
- 8 Duct connection for discharge

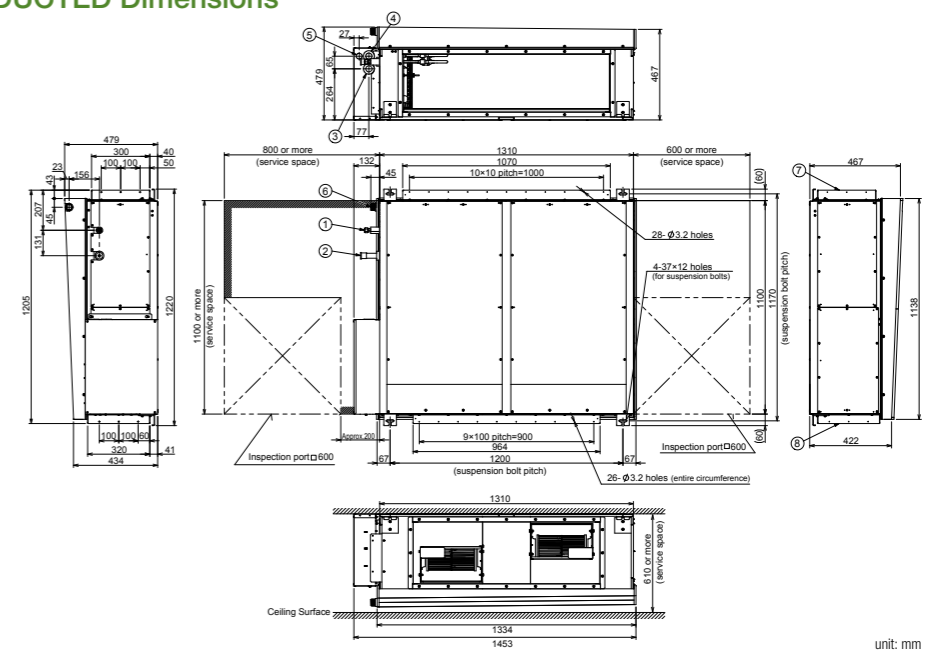

E1 TYPE High Static Ducted Concealed duct

Hidden in the ceiling to provide an ideal match for luxury residences and light commercial buildings.



Optional accessory



Technical focus

- Complete flexibility for ductwork design
- Can be located into a weatherproof housing for external installation
- Up to 150 pa external static pressure
- Discharge air temperature control to reduce cold drafts during heating operation
- Configurable air temperature control
- Up to 70 L/s air flow

System Example

An inspection port (450 mm x 450 mm or more) is required at the control-box side of the indoor unit body.

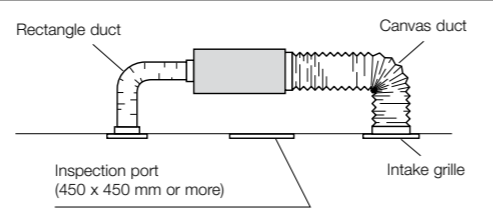

Cold Drafts Reduction at Heating

- Accurate temperature measurement by E1/E3 sensor to reduce cold drafts at heating.

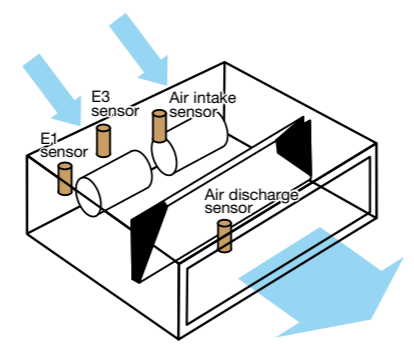

Compact Body Size

Hidden in the ceiling, ideal when interior decor is an important consideration such as in residences with many rooms and light commercial buildings.

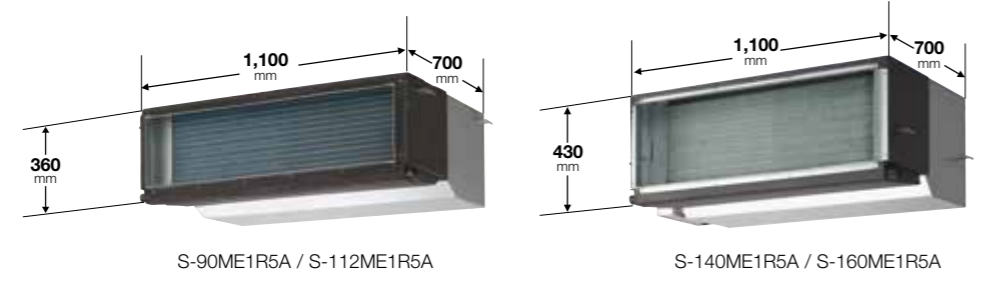

Model Name		S-90ME1R5A	S-112ME1R5A	S-140ME1R5A	S-160ME1R5A	
Power source		230/240V, 1 phase - 50Hz				
Cooling capacity	kW	9.0	11.2	14.0	16.0	
	BTU/h	30,700	38,200	47,800	54,600	
Heating capacity	kW	10.0	12.5	16.0	18.0	
	BTU/h	34,100	42,700	54,600	61,400	
Power input	Cooling kW	0.275/0.290	0.390/0.410	0.410/0.430	0.590/0.640	
	Heating kW	0.275/0.290	0.390/0.410	0.410/0.430	0.590/0.640	
Running current	Cooling A	1.24/1.25	1.72/1.74	1.82/1.84	2.62/2.70	
	Heating A	1.24/1.25	1.72/1.74	1.82/1.84	2.62/2.70	
Fan	Type	Sirocco fan				
	Air flow rate (H/M/L)	m³/h	1,800/1,560/1,320	2,400/2,100/1,740	3,000/2,760/2,160	3,600/3,000/2,520
		L/s	500/433/367	667/583/483	833/767/600	1,000/833/700
	Motor output	kW	0.155	0.275	0.310	0.44
	External static pressure	Pa	100 (10-150)	100 (10-150)	100 (10-150)	100 (10-150)
Sound power level (H/M/L)	dB	62/61/60	70/68/66	71/69/67	73/71/69	
Sound pressure level (H/M/L)	dB(A)	45/44/43	48/46/44	49/47/45	51/49/47	
Dimensions	H x W x D	mm	360 x 1,100(+100) x 700	360 x 1,100(+100) x 700	430 x 1,100(+100) x 700	430 x 1,100(+100) x 700
	Liquid	mm (inches)	Ø9.52 (Ø3/8)	Ø9.52 (Ø3/8)	Ø9.52 (Ø3/8)	Ø9.52 (Ø3/8)
Pipe connections	Gas	mm (inches)	Ø15.88 (Ø5/8)	Ø15.88 (Ø5/8)	Ø15.88 (Ø5/8)	Ø15.88 (Ø5/8)
	Drain piping		VP-25	VP-25	VP-25	VP-25
Net weight	kg	42	44	48	53	

GLOBAL REMARKS	Rated conditions:	
	Cooling	Heating
	Indoor air temperature 27°C DB / 19°C WB	20°C DB
Outdoor air temperature 35°C DB / 24°C WB	7°C DB / 6°C WB	

Specifications are subject to be changed without notice.

E1 TYPE HIGH STATIC DUCTED Dimensions

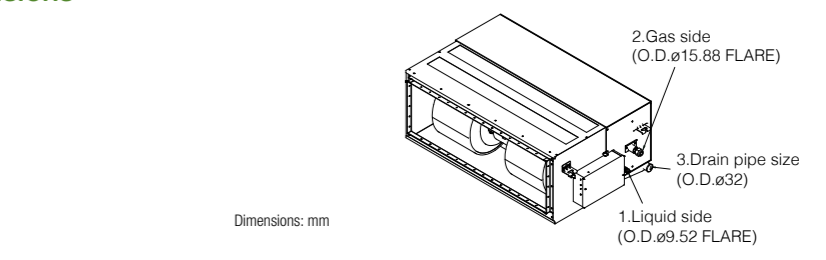
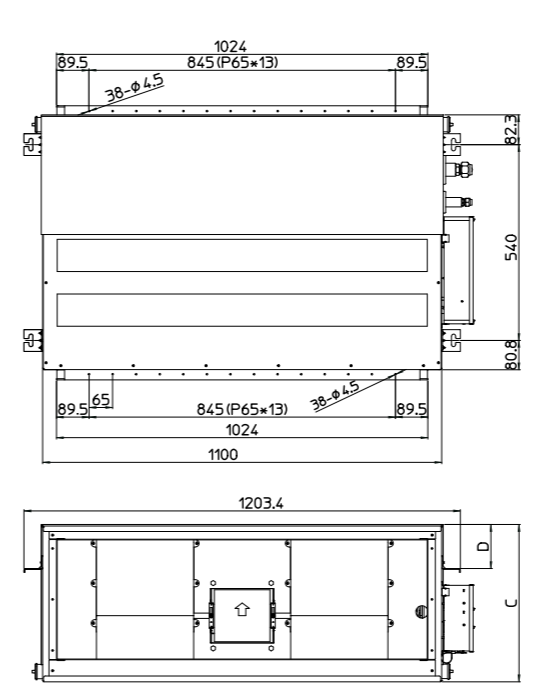

model	A	B	C	D
S-90ME1R5A S-112ME1R5A	195	35.7	360	50
S-140ME1R5A S-160ME1R5A	260	38.2	430	121.5

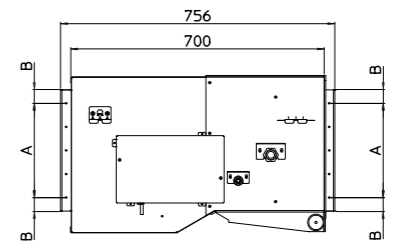

K2_{TYPE} Wall Mounted



The K2 type wall mounted unit has a stylish smooth design with a washable front panel. Small, lightweight and low noise level makes it ideal for small offices and other commercial applications.



S-22MK2E5B / S-28MK2E5B
S-36MK2E5B

S-45MK2E5B / S-56MK2E5B
S-73MK2E5B / S-106MK2E5B

Optional accessory



CZ-RTC6WBL

CZ-RTC6BL

CZ-RTC5B

CZ-RWS3
*Remote controller

*Receiver is included in the wall mounted indoor unit.

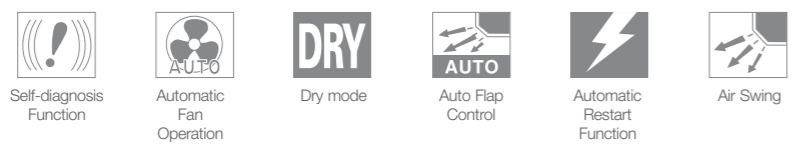

Technical focus

- Closed discharge port when not in use
- Lighter and smaller units make installation easy
- Quiet operation
- Smooth and durable design
- Piping outlet in six directions
- Washable front panel
- Air distribution is automatically altered depending on the operational mode of the unit

Noise reducing external valve kit

To reduce noise level of expansion valve. (Optional accessory)

CZ-P56SVK2 (for 22 - 56 type)
CZ-P160SVK2 (for 73* - 106 type)

*When the pipe diameter is (Liquid) Ø6.35 - (Gas) Ø12.7, please use CZ-P56SVK2.



Closed discharge port

When the unit is turned off, the flap closes completely to prevent entry of dust into the unit and to keep the equipment clean.

Compact indoor units make the installation easy

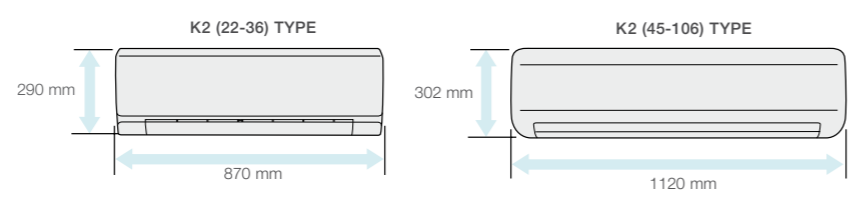

Quiet operation

Low operating noise level makes these units ideal for hotels and hospital applications.

Smooth and durable design

The smooth cover means these units match most modern interiors. Their compact size enables them to blend in, even in small spaces.

Piping outlet in six directions

Piping outlet is possible in the six directions of right, right rear, right bottom, left, left rear, left bottom, making installation easier.

Washable front panel

The indoor unit's front panel can be easily removed and washed for trouble-free maintenance.



Air distribution is automatically adjusted depending on the operational mode of the unit

Air outlet angle is automatically adjusted for cooling and heating operation.

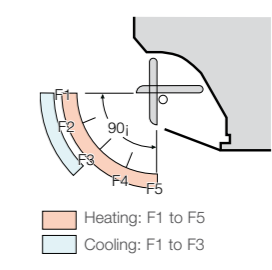

K2_{TYPE} Wall Mounted

Model Name		S-22MK2E5B	S-28MK2E5B	S-36MK2E5B	S-45MK2E5B	
Power source		220/230/240V, 1 phase - 50/60Hz				
Cooling capacity	kW	2.2	2.8	3.6	4.5	
	BTU/h	7,500	9,600	12,300	15,400	
Heating capacity	kW	2.50	3.20	4.20	5.0	
	BTU/h	8,500	10,900	14,300	17,100	
Power input	Cooling kW	0.025/0.025/0.025	0.025/0.025/0.025	0.030/0.030/0.030	0.030/0.030/0.030	
	Heating kW	0.025/0.025/0.025	0.025/0.025/0.025	0.030/0.030/0.030	0.030/0.030/0.030	
Running current	Cooling A	0.21	0.23	0.25	0.33/0.32/0.31	
	Heating A	0.21	0.23	0.25	0.33/0.32/0.31	
Fan	Type	Cross-flow fan	Cross-flow fan	Cross-flow fan	Cross-flow fan	
	Air flow rate (H/M/L)	m ³ /h	540/450/390	570/498/390	654/540/390	870/750/600
		L/s	150/125/108	158/138/108	181/150/108	242/208/167
	Motor output	kW	0.03	0.03	0.03	0.054
Sound power level (H/M/L)	dB	51/48/44	52/49/44	55/51/44	53/50/48	
Sound pressure level (H/M/L)	dB(A)	36/33/29	37/34/29	40/36/29	38/35/33	
Dimensions	H x W x D	mm	290 x 870 x 214	290 x 870 x 214	290 x 870 x 214	302 x 1,120 x 236
	Liquid	mm (inches)	Ø6.35 (Ø1/4)	Ø6.35 (Ø1/4)	Ø6.35 (Ø1/4)	Ø6.35 (Ø1/4)
	Gas	mm (inches)	Ø12.7 (Ø1/2)	Ø12.7 (Ø1/2)	Ø12.7 (Ø1/2)	Ø12.7 (Ø1/2)
Pipe connections	Gas	mm (inches)	Ø12.7 (Ø1/2)	Ø12.7 (Ø1/2)	Ø12.7 (Ø1/2)	Ø12.7 (Ø1/2)
	Drain piping	mm	Ø18	Ø18	Ø18	Ø18
Net weight	kg	9	9	9	13	

	S-56MK2E5B	S-73MK2E5B	S-106MK2E5B		
Power source	220/230/240V, 1 phase - 50/60Hz				
Cooling capacity	5.6	7.3	10.6		
	19,100	24,900	36,200		
Heating capacity	6.3	8.0	11.4		
	21,500	27,300	38,900		
Power input	Cooling kW	0.035/0.035/0.035	0.055/0.055/0.055	0.080/0.080/0.080	
	Heating kW	0.035/0.035/0.035	0.055/0.055/0.055	0.080/0.080/0.080	
Running current	Cooling A	0.36/0.35/0.34	0.52/0.51/0.50	0.72/0.70/0.68	
	Heating A	0.36/0.35/0.34	0.52/0.51/0.50	0.72/0.70/0.68	
Fan	Type	Cross-flow fan	Cross-flow fan	Cross-flow fan	
	Air flow rate (H/M/L)	m ³ /h	960/840/720	1,170/1,020/840	1,290/1,110/900
		L/s	267/233/200	325/283/233	358/308/250
	Motor output	kW	0.054	0.054	0.054
Sound power level (H/M/L)	dB	55/52/50	62/59/55	64/61/57	
Sound pressure level (H/M/L)	dB(A)	40/37/35	47/44/40	49/46/42	
Dimensions	H x W x D	mm	302 x 1,120 x 236	302 x 1,120 x 236	302 x 1,120 x 236
	Liquid	mm (inches)	Ø6.35 (Ø1/4)	Ø9.52 (Ø3/8)	Ø9.52 (Ø3/8)
	Gas	mm (inches)	Ø12.7 (Ø1/2)	Ø15.88 (Ø5/8)	Ø15.88 (Ø5/8)
Pipe connections	Gas	mm (inches)	Ø12.7 (Ø1/2)	Ø15.88 (Ø5/8)	Ø15.88 (Ø5/8)
	Drain piping	mm	Ø18	Ø18	Ø18
Net weight	kg	13	14	14	

GLOBAL REMARKS	Rated conditions:	
	Cooling	Heating
	Indoor air temperature	27°C DB / 19°C WB
Outdoor air temperature	35°C DB / 24°C WB	7°C DB / 6°C WB

Specifications are subject to change without notice.

K2 (22-36) TYPE WALL MOUNTED Dimensions

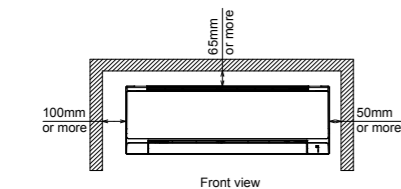
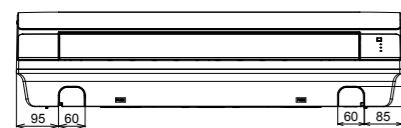
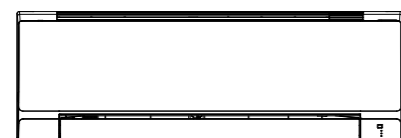

- 1 Refrigerant piping (liquid pipe) ø6.35(flared)
- 2 Refrigerant piping (gas pipe) ø12.7(flared)
- 3 Drain hose (outer dia. ø16)
- 4 Rear panel (PL BACK)
- 5 Rear panel fixing holes (ø5 holes or 5X13 oval holes)
- 6 Piping and wiring holes (ø70)

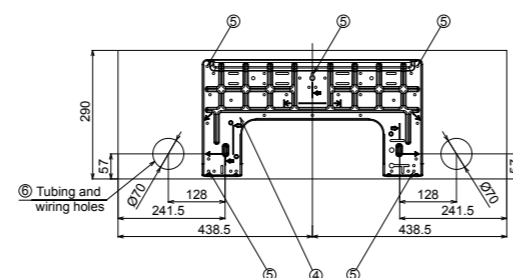
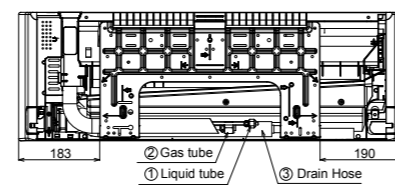
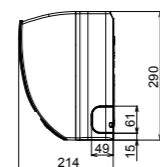

unit: mm

K2 (45-106) TYPE WALL MOUNTED Dimensions

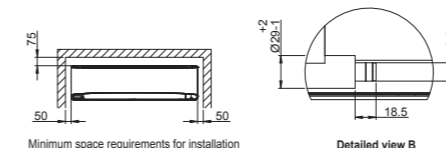
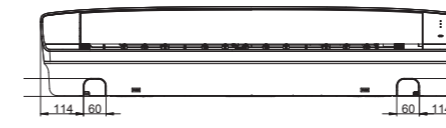
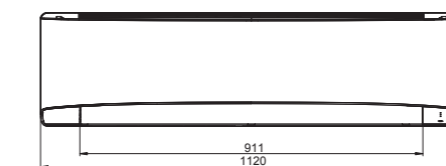

- 1 Refrigerant piping (liquid pipe) 45-56 / 73-106 type ø6.35 / ø9.52 (flared)
- 2 Refrigerant piping (gas pipe) 45-56 / 73-106 type ø12.7 / ø15.88 (flared)
- 3 Drain hose VP13 (outer dia. ø18)
- 4 Rear panel (PL BACK)
- 5 Piping and wiring holes (ø80)

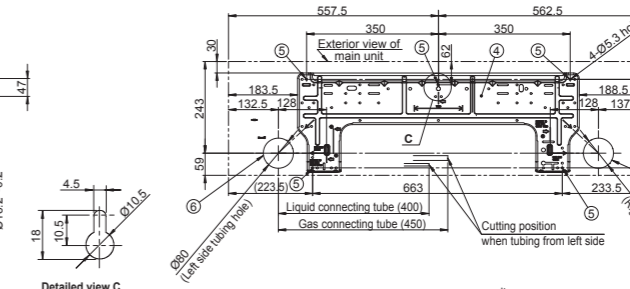
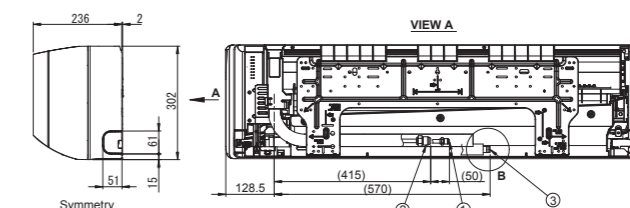

unit: mm

NEW
U2 TYPE 4-Way Cassette
 Semi concealed cassette



nanoe™ X
 Generator Mark3



Please refer to the nanoe™ X website for the Mark 3 information.

Provides a neat fit in the ceiling to match modern décor, and uniform cooling throughout the room, and easy installation.



- 1 [1] Air intake flange (ø100) (field supply)
 - 2 [2] Air intake box CZ-ATU2*(ø100)
 - 3 [3] Air intake plenum CZ-FDU3
- * When using Air intake box (CZ-ATU2), Air intake plenum (CZ-FDU3) is required.

NEW PANEL DESIGN
 Flat design, well-matched with interior, building.



Normal Panel : CZ-KPU3H



Optional accessory



CZ-RTC6WBL

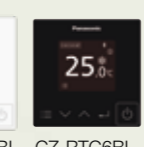

CZ-RTC6BL



CZ-RTC5B



CZ-RWS3 Remote controller



CZ-RWRU3 Receiver

- Self-diagnosis Function
- Automatic Fan Operation
- Dry mode
- Intelligent Auto Swing
- Automatic Restart Function
- Auto Swing (Auto Flap Control)
- Built-in Drain Pump

Technical focus

- New high performance turbo fan, new path system for heat exchanger
- Lower noise in slow fan operation
- Industry top light weight, easy piping
- Easy installation structure of the panel
- Econavi : Floor temperature and human sensor added. Activity amount detection and new circulator
- nanoe™ X : 100x for CAC (100 times more nanoe™ particle for wide commercial space). Inside cleaning by 100x nanoe™ + dry control

Flat Horizontal Design

The horizontal design of 4-way cassette achieves an elegant designed panel. Its slim design allow to protrude 33.5mm from the ceiling.

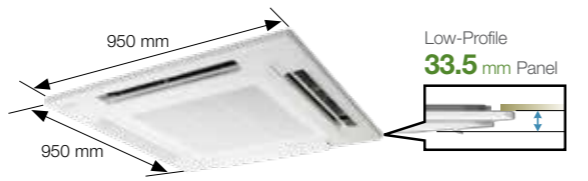

Drain pump of up to 850 mm from the ceiling surface

Built in drain pump allows flexible install and design options with up to 850mm lift. Long horizontal piping is also possible.

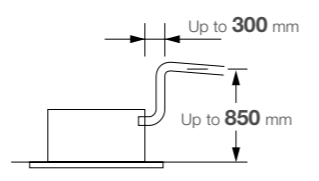

Easy to clean suction grille

Suction grille is able to make 90-degree turns.



360° Wide & Comfortable Airflow

Comfort air flow control and proper energy use. Flexible Air Flow direction control by individual flap control:
 -4 Flaps can be controlled individually (by standard wired remote controller*)
 -Versatile air flow control to cover a wide variety of demands.

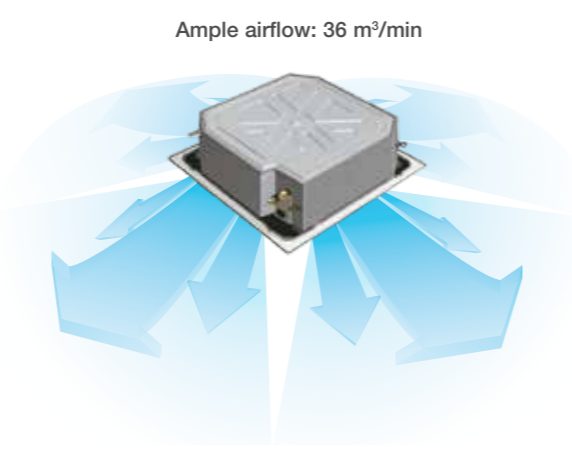
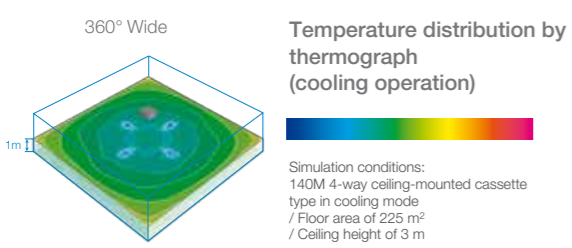

*Pre-setting is required for this function at System Test-run procedure

High-ceiling installation (Up to 5 m for 10.6 kW and higher capacity models)

The units can be installed in rooms with high ceilings, where they provide ample floor-level heating in the winter. (See ceiling height guidelines below.)

High Ceiling (Factory settings)

New model	2.7m	3.0m	3.6m		
	Capacity	2.2-5.6kW	6.0-9.0kW	11.2-16.0kW	
11.2-16.0kW	Industry's top-class	4.5m	4.7m	5m	
		Capacity	4-way discharge high ceiling setting 2	3-way discharge with the optional air-blocking materials	2-way discharge with the optional air-blocking materials

Ceiling height guidelines

Indoor unit	*1 settings 4-way discharge			3-way discharge (optional air-blocking materials)	2-way discharge (optional air-blocking materials) *2
	Factory setting 1	High ceiling setting 1	High ceiling setting 2		
2.2-5.6kW	2.7	3.2	3.5	3.8	4.2
6.0-9.0kW	3.0	3.3	3.6	3.8	4.2
11.2-16.0kW	3.6	4.3	5.0	4.7	5.0

*1 When using the unit in a configuration other than the factory settings, it is necessary to make settings on site to increase airflow.
 *2 Use air-blocking materials (CZ-CFU3) to completely block two discharge outlets for 2-way airflow.

Panels & Panel parts

Normal panel: CZ-KPU3H



Wireless receiver (option)

nanoe™ X Generator Mark 3

nanoe™ X contains plenty of OH radicals that have outstanding effects on various air pollutants, including bacteria and viruses, mould, allergens, pollen, hazardous substances, as well as deodorise odours. It also keeps moisture in your skin and hair.



Invisible Air Contaminants are Suppressed



U2_{TYPE} 4-Way Cassette

Model Name		S-22MU2E5BN	S-28MU2E5BN	S-36MU2E5BN	S-45MU2E5BN	S-56MU2E5BN	
Power source		220/230/240 V, 1 phase - 50Hz/60Hz					
Cooling capacity	kW	2.2	2.8	3.6	4.5	5.6	
	BTU/h	7,500	9,600	12,300	15,400	19,100	
Heating capacity	kW	2.5	3.2	4.2	5.0	6.3	
	BTU/h	8,500	10,900	14,300	17,100	21,500	
Power input	Cooling kW	0.020/0.020/0.020	0.020/0.020/0.020	0.020/0.020/0.020	0.020/0.020/0.020	0.025/0.025/0.025	
	Heating kW	0.020/0.020/0.020	0.020/0.020/0.020	0.020/0.020/0.020	0.020/0.020/0.020	0.025/0.025/0.025	
Running current	Cooling A	0.21/0.21/0.20	0.21/0.21/0.20	0.21/0.21/0.20	0.21/0.21/0.20	0.24/0.23/0.22	
	Heating A	0.20/0.20/0.19	0.20/0.20/0.19	0.20/0.20/0.19	0.20/0.20/0.19	0.23/0.22/0.21	
Fan	Type	Turbo fan					
	Air flow rate (H/M/L)	m ³ /h	768/726/690	768/726/690	870/780/690	930/780/690	990/810/690
		L/s	213/202/192	213/202/192	242/217/192	258/217/192	275/225/192
	Motor output	kW					
Sound power level (H/M/L)	dB	45/44/43					
Sound pressure level (H/M/L)	dB(A)	30/29/28					
Dimensions* H x W x D	mm	256+(33.5) x 840 (950) x 840 (950)					
Pipe connections	Liquid	mm (inches)					
	Gas	mm (inches)					
	Drain piping	VP-25					
Net weight* (Panel)	kg	19 (+5)					

S-60MU2E5BN	S-73MU2E5BN	S-90MU2E5BN	S-112MU2E5BN	S-140MU2E5BN	S-160MU2E5BN
220/230/240 V, 1 phase - 50Hz/60Hz					
6.0	7.3	9.0	11.2	14.0	16.0
20,500	24,900	30,700	38,200	47,800	54,600
7.1	8.0	10.0	14.0	16.0	18.0
24,200	27,300	34,100	47,800	54,600	61,400
0.035/0.035/0.035	0.040/0.040/0.040	0.040/0.040/0.040	0.095/0.095/0.095	0.095/0.095/0.095	0.105/0.105/0.105
0.035/0.035/0.035	0.040/0.040/0.040	0.040/0.040/0.040	0.090/0.090/0.090	0.090/0.090/0.090	0.100/0.100/0.100
0.34/0.33/0.32	0.37/0.36/0.35	0.39/0.38/0.37	0.77/0.74/0.71	0.77/0.74/0.71	0.85/0.82/0.79
0.33/0.32/0.31	0.36/0.35/0.34	0.38/0.37/0.36	0.75/0.72/0.69	0.75/0.72/0.69	0.83/0.80/0.77
Turbo fan	Turbo fan	Turbo fan	Turbo fan	Turbo fan	Turbo fan
1,260/960/780	1,350/960/780	1,380/1,110/840	2,160/1,560/1,200	2,160/1,560/1,200	2,220/1,680/1,440
350/267/217	375/267/217	383/308/233	600/433/333	600/433/333	617/467/400
0.06	0.06	0.06	0.09	0.09	0.09
51/47/44	52/47/44	53/50/47	60/54/50	60/54/50	61/55/53
36/32/29	37/32/29	38/35/32	45/39/35	45/39/35	46/40/38
319+(33.5) x 840 (950) x 840 (950)					
Ø6.35 (Ø1/4)	Ø6.35 (Ø1/4)	Ø6.35 (Ø1/4)	Ø9.52 (Ø3/8)	Ø9.52 (Ø3/8)	Ø9.52 (Ø3/8)
Ø12.7 (Ø1/2)	Ø12.7 (Ø1/2)	Ø12.7 (Ø1/2)	Ø15.88 (Ø5/8)	Ø15.88 (Ø5/8)	Ø15.88 (Ø5/8)
VP-25	VP-25	VP-25	VP-25	VP-25	VP-25
20 (+5)	20 (+5)	20 (+5)	25 (+5)	25 (+5)	25 (+5)

Global remarks	Rated conditions:	
	Cooling	Heating
	Indoor air temperature	27°C DB / 19°C WB
Outdoor air temperature	35°C DB / 24°C WB	7°C DB / 6°C WB

* The values in () for external dimensions and Net weight are the values for the optional ceiling panel.
In the case of nanoe X OFF
Specifications are subject to change without notice.

Standard Equipped nanoe™ Technology

- nanoe™ X, charged water particles, contain hydroxyl radical (OH radical) that work to provide quality air.
- The electrodes of nanoe™ X devices are made of titanium and electricity discharge into the water particles of nanoe™. So no need to clean or replace the device (maintenance free without wear).



Craftsmanship in Japan enables the adoption of titanium

Electrodes of nanoe™ X devices are produced with the support of craftsmen in Japan that has advanced expertise on processing ultra-small parts of titanium glass frames although titanium is very strong material and difficult to process.



nanoe™ X module

Unique nanoe™ X module casing releases 48 trillion hydroxyl radical (OH radical) per second.



nanoe™ X device

U2 TYPE 4-WAY CASSETTE Dimensions

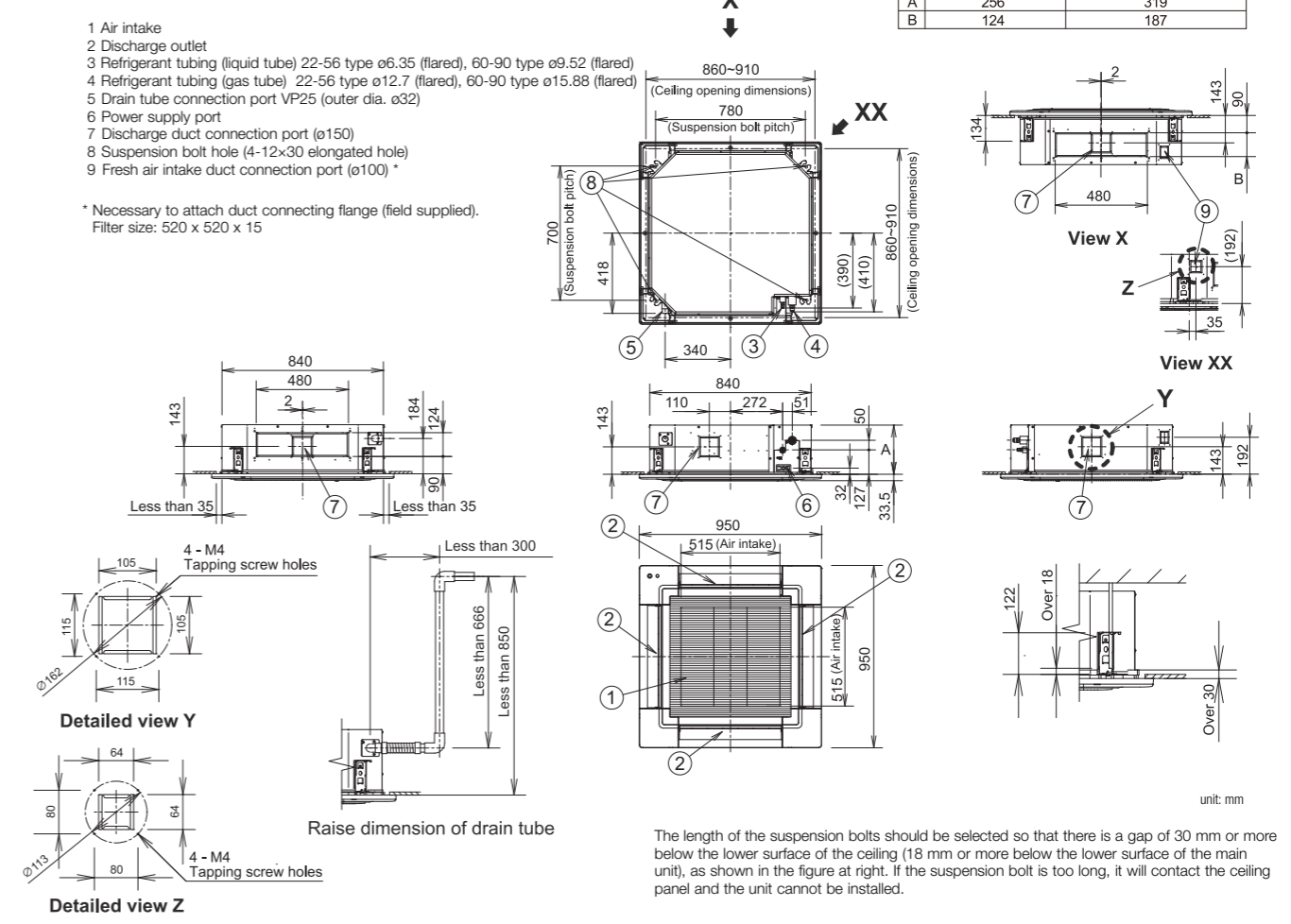

Y3 TYPE 4-Way Mini Cassette

Mini semi concealed cassette



Designed to fit perfectly into a 60 x 60 cm ceiling grid without the need to alter the bar configuration, the Y3 is ideal for small commercial and retrofit applications. In addition, improvements to the Y3's efficiency make this model one of the most advanced units in the industry.

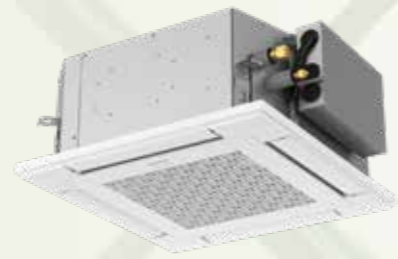

Optional accessory



Please refer to the nanoe™ X website for the Mark 3 information.

Technical focus

- Mini cassette fits into a 60 x 60 cm ceiling grid
- Powerful drain pump gives 850 mm lift
- Multi-directional air flow
- Easy installation
- DC fan motor with variable speed and a new heat exchanger ensures efficient power consumption
- nanoe™ X : 100x for CAC (100 times more nanoe™ particle for wide commercial space). Inside cleaning by 100x nanoe™ + dry control

Compact design

Thanks to advanced Panasonic design the panel is a compact 625 x 625 mm, offering elegant, unobtrusive installation even where space is limited.

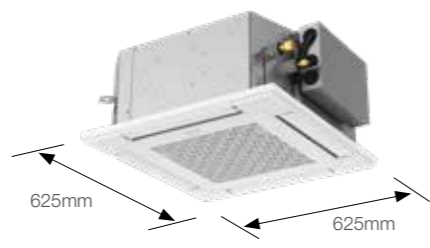

Lighter and slimmer, easier installation

When only 230 mm of indoor body height, it can easily fit in limited spaces and tight spots. (Required 243 mm from bottom of panel to top of the unit)

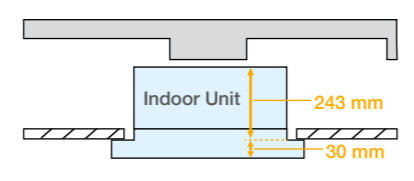

Individual flap control

Keep everyone comfortable by directing air where it's needed and away from where it isn't with individual flap control.

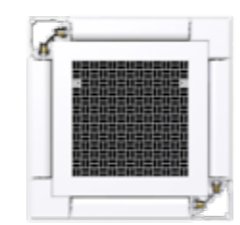

A drain height of up to 850 mm from the ceiling surface

The internal pump allows the drain pipe to be elevated up to 850 mm above the base of the unit.

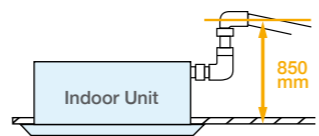

Model Name		S-22MY3E	S-28MY3E	S-36MY3E	S-45MY3E	S-56MY3E
Power source		220/230/240 V, 1 phase - 50Hz/60Hz				
Cooling capacity	kW	2.2	2.8	3.6	4.5	5.6
	BTU/h	7,500	9,600	12,300	15,400	19,100
Heating capacity	kW	2.5	3.2	4.2	5.0	6.3
	BTU/h	8,500	10,900	14,300	17,100	21,500
Power input	Cooling kW	0.020	0.021	0.022	0.030	0.042
	Heating kW	0.018	0.019	0.020	0.028	0.040
Running amperes	Cooling A	0.25 0.24 0.23	0.26 0.25 0.24	0.27 0.26 0.25	0.35 0.34 0.33	0.44 0.43 0.42
	Heating A	0.22 0.21 0.20	0.23 0.22 0.21	0.24 0.23 0.22	0.32 0.31 0.30	0.41 0.40 0.39
Fan motor	Type	Turbo fan				
	Airflow rate (H/M/L) m³/h	522/420/360	540/450/360	570/468/360	690/540/390	810/630/480
	(H/M/L) L/s	145/117/100	150/125/100	158/130/100	192/150/108	225/175/133
	Output kW	0.03	0.03	0.03	0.03	0.03
Sound power level (H/M/L)	Cooling dB	48/45/43	49/45/43	50/46/43	54/49/45	57/52/48
	Heating dB	48/45/43	49/45/43	50/46/43	54/49/45	57/52/48
Sound pressure level (H/M/L)	Cooling dB(A)	33/30/28	34/30/28	35/31/28	39/34/30	42/37/33
	Heating dB(A)	33/30/28	34/30/28	35/31/28	39/34/30	42/37/33
Dimensions* H x W x D mm		243(+30) x 575(625) x 575(625)	243(+30) x 575(625) x 575(625)	243(+30) x 575(625) x 575(625)	243(+30) x 575(625) x 575(625)	243(+30) x 575(625) x 575(625)
	Liquid mm (inches)	Ø6.35	Ø6.35	Ø6.35	Ø6.35	Ø6.35
Pipe connections	Gas mm (inches)	Ø12.7	Ø12.7	Ø12.7	Ø12.7	Ø12.7
	Drain piping	VP-20	VP-20	VP-20	VP-20	VP-20
Net weight*	kg	15(+2.8)	15(+2.8)	15(+2.8)	15(+2.8)	15(+2.8)
Global remarks	Rated conditions:	Cooling	Heating			
	Indoor air temperature	27°C DB / 19°C WB	20°C DB/ 15°C WB			
	Outdoor air temperature	35°C DB/ 24°C WB	7°C DB/ 6°C WB			

* The values in () for external dimensions and Net weight are the values for the optional ceiling panel. Specifications are subject to change without notice.

Y3 TYPE 4-WAY CASSETTE Dimensions

unit: mm

1	Air intake grille
2	Air outlet
3	Refrigerant piping (liquid pipe) 25.36,50:ø6.35 (flared) 60:ø9.52 (flared) *1
4	Refrigerant piping (gas pipe) 25.36,50:ø12.7 (flared) 60:ø15.88 (flared) *2
5	Drain tube connection port VP20
6	Power supply entry
7	Suspension bolt hole (4-11 x 26 slot)
8	Fresh air intake duct connection port (ø100) *3

* Necessary to attach duct connecting flange (field supply). <Filter dimension> 362 x 362 x 15

L1 TYPE 2-Way Cassette

The L1 is very thin, compact and light, allowing flexible install options. A redesigned fan has been used to achieve this size and weight reduction.

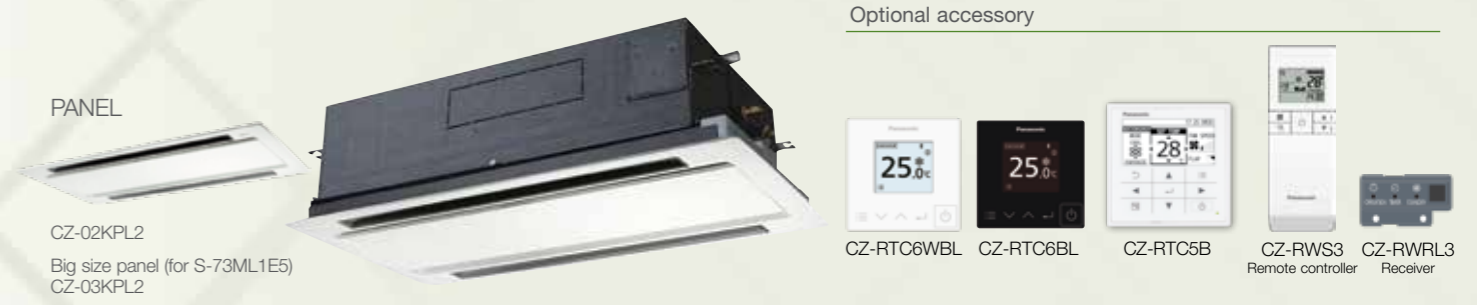

Technical focus

- Airflow and distribution is automatically altered depending on the operational mode of the unit
- Drain up is possible up to 500 mm via the built-in drain pump
- Simple maintenance

Auto flap control

Airflow and distribution is automatically altered depending on the operational mode (cooling or heating) of the unit.

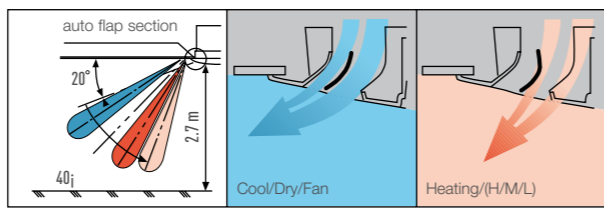

Drain pump of up to 810 mm from the ceiling surface

Maintenance of the drain pump is possible from both sides, from the left side (piping side) and from the inside of the unit.

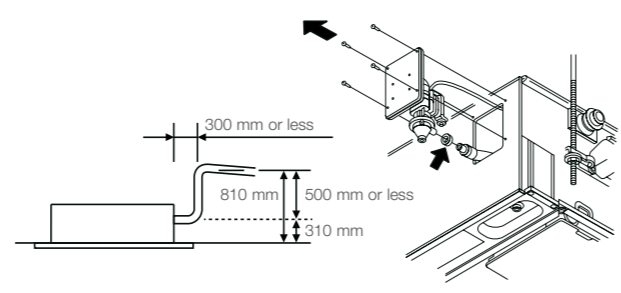

Simple maintenance

The drain pan is equipped with site wiring and can be removed. The fan case has a split construction, and the fan motor can be removed easily when the lower case is removed.

Model Name		S-22ML1E5	S-28ML1E5	S-36ML1E5	S-45ML1E5	S-56ML1E5	S-73ML1E5	
Power source		220/230/240 V, 1 phase - 50/60 Hz						
Cooling capacity	kW	2.2	2.8	3.6	4.5	5.6	7.3	
	BTU/h	7,500	9,600	12,000	15,000	19,000	25,000	
Heating capacity	kW	2.5	3.2	4.2	5.0	6.3	8.0	
	BTU/h	8,500	11,000	14,000	17,000	21,000	27,000	
Power input	Cooling kW	0.086/0.090/0.095	0.086/0.092/0.097	0.088/0.093/0.099	0.091/0.097/0.103	0.091/0.097/0.103	0.135/0.145/0.154	
	Heating kW	0.055/0.058/0.062	0.055/0.060/0.064	0.057/0.061/0.066	0.060/0.065/0.070	0.060/0.065/0.070	0.100/0.109/0.117	
Running current	Cooling A	0.45/0.45/0.45	0.44/0.45/0.45	0.44/0.45/0.45	0.45/0.45/0.45	0.45/0.45/0.45	0.64/0.65/0.66	
	Heating A	0.29/0.29/0.30	0.28/0.29/0.30	0.28/0.29/0.30	0.29/0.29/0.30	0.29/0.29/0.30	0.46/0.48/0.49	
Fan	Type	Sirocco fan	Sirocco fan	Sirocco fan	Sirocco fan	Sirocco fan	Sirocco fan	
	Air flow rate (H/M/L)	m³/h	480/420/360	540/480/420	580/520/460	660/540/480	660/540/480	1,140/960/840
	L/s		133/117/100	150/133/117	161/144/128	183/150/133	183/150/133	317/267/233
	Motor output	kW	0.03	0.03	0.03	0.03	0.03	0.05
Sound power level (H/M/L)	dB	40/38/35	44/40/37	45/42/39	46/44/40	46/44/40	49/46/44	
Sound pressure level (H/M/L)	dB(A)	30/27/24	33/29/26	34/31/28	35/33/29	35/33/29	38/35/33	
Dimensions * H x W x D	mm	350+8x840 (1,060) x600 (680)	350+8x840 (1,060) x600 (680)	350+8x840 (1,060) x600 (680)	350+8x840 (1,060) x600 (680)	350+8x840 (1,060) x600 (680)	350+8x 1,140 (1,360) x600 (680)	
	Liquid	mm (inches)	Ø6.35 (Ø1/4)	Ø6.35 (Ø1/4)	Ø6.35 (Ø1/4)	Ø6.35 (Ø1/4)	Ø6.35 (Ø1/4)	Ø9.52 (Ø3/8)
Pipe connections	Gas	mm (inches)	Ø12.7 (Ø1/2)	Ø12.7 (Ø1/2)	Ø12.7 (Ø1/2)	Ø12.7 (Ø1/2)	Ø12.7 (Ø1/2)	
	Drain piping		VP-25	VP-25	VP-25	VP-25	VP-25	
Net weight *	kg	23 (+5.5)	23 (+5.5)	23 (+5.5)	23 (+5.5)	23 (+5.5)	30 (+9)	

GLOBAL REMARKS	Rated conditions:		
	Cooling	Heating	
	Indoor air temperature	27°C DB / 19°C WB	20°C DB
Outdoor air temperature	35°C DB / 24°C WB	7°C DB / 6°C WB	

* The values in () for external dimensions and Net weight are the values for the optional ceiling panel. Specifications are subject to change without notice.

L1 TYPE 2-WAY CASSETTE Dimensions

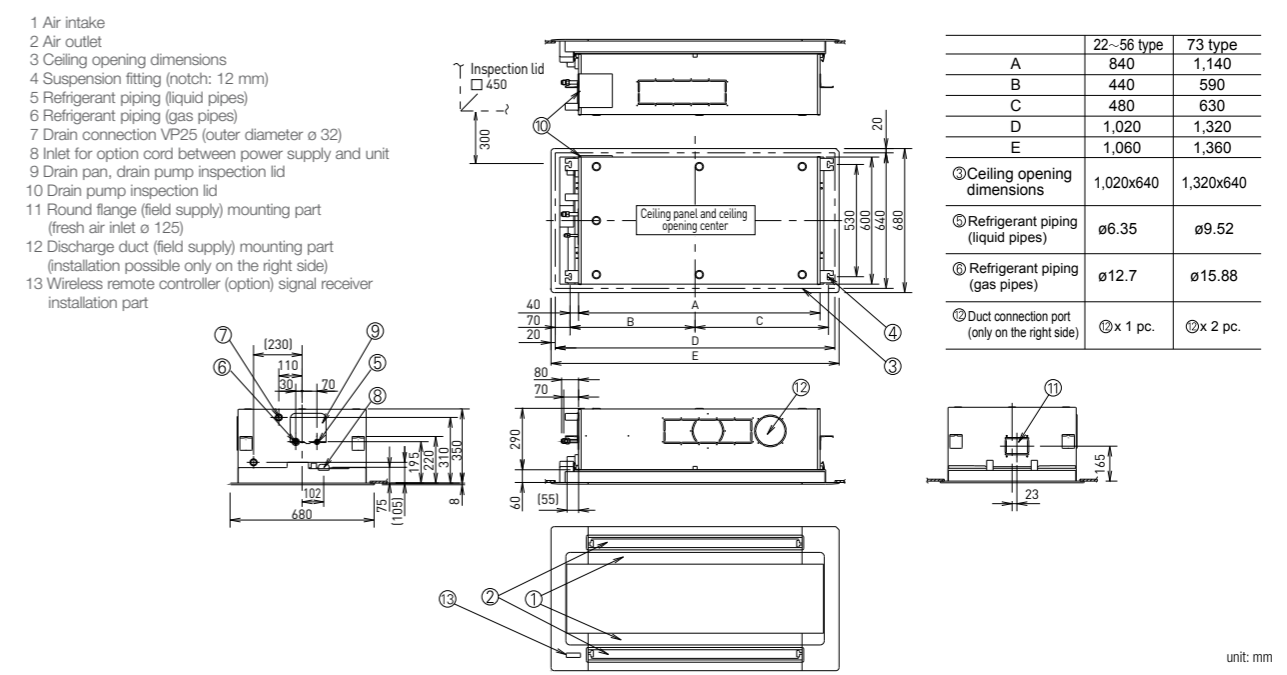

D1 TYPE 1-Way Cassette

Semi concealed slim cassette



Designed for installation within the ceiling void, the D1 range of slimline 1 way cassettes feature a quiet yet powerful fan that can reach the floor up 4.2 m from ceiling height.

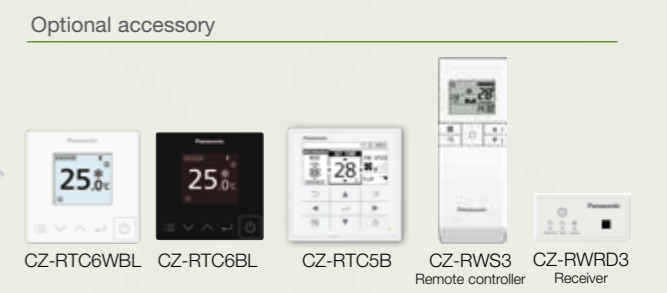

Technical focus

- Ultra-Slim profile
- Suitable for standard and high ceilings
- Built-in drain pump provides 590 mm lift from ceiling
- Easy to install and maintain
- Hanging height can be easily adjusted
- Uses a DC fan motor to improve energy-efficiency

Drain height

A built-in drain pump provides up to 590mm lift from ceiling height for flexible install options.

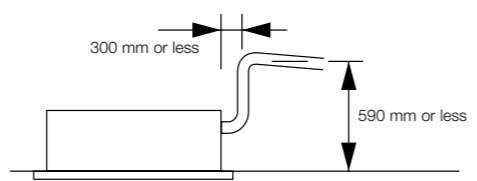

With 3 types of air-blow systems, the units can be used in various ways.



(1) One-direction "down-blow" system

Powerful one-direction "down-blow" system reaches the floor even from high ceilings (up to 4.2 m).



(2) Two-direction ceiling-mounted system

"Down-blow" and "front-blow" systems are combined in a ceiling-mounted unit to blow air over a wide area.



(3) One-direction ceiling-mounted system

This powerful ceiling-mounted "front-blow" system efficiently air-conditions the space in front of the unit. (Additional accessories required)

Model Name		S-28MD1E5	S-36MD1E5	S-45MD1E5	S-56MD1E5	S-73MD1E5
Power source		220/230/240 V, 1 phase - 50/60 Hz				
Cooling capacity	kW	2.8	3.6	4.5	5.6	7.3
	BTU/h	9,600	12,000	15,000	19,000	25,000
Heating capacity	kW	3.2	4.2	5.0	6.3	8.0
	BTU/h	11,000	14,000	17,000	21,000	27,000
Power input	Cooling kW	0.050/0.051/0.052	0.050/0.051/0.052	0.050/0.051/0.052	0.058/0.060/0.061	0.086/0.087/0.089
	Heating kW	0.039/0.040/0.042	0.039/0.040/0.042	0.039/0.040/0.042	0.046/0.048/0.049	0.075/0.076/0.077
Running current	Cooling A	0.40/0.39/0.39	0.40/0.39/0.39	0.40/0.39/0.39	0.46/0.46/0.46	0.71/0.70/0.69
	Heating A	0.36/0.35/0.35	0.36/0.35/0.35	0.36/0.35/0.35	0.42/0.41/0.41	0.66/0.65/0.63
Fan	Type	Sirocco fan				
	Air flow rate (H/M/L) m³/h	720/600/540	720/600/540	720/660/600	780/690/600	1,080/900/780
	L/s	200/167/150	200/167/150	200/183/167	217/192/167	300/250/217
	Motor output kW	0.05				
Sound power level (H/M/L) dB	47/45/44					
Sound pressure level (H/M/L) dB(A)	36/34/33					
Dimensions * H x W x D mm	200+(20) x 1,000 (1,230) x 710 (800)					
	Liquid mm (inches)	Ø6.35 (Ø1/4)	Ø6.35 (Ø1/4)	Ø6.35 (Ø1/4)	Ø6.35 (Ø1/4)	Ø9.52 (Ø3/8)
Pipe connections	Gas mm (inches)	Ø12.7 (Ø1/2)	Ø12.7 (Ø1/2)	Ø12.7 (Ø1/2)	Ø12.7 (Ø1/2)	Ø15.88 (Ø5/8)
	Drain piping	VP-25				
Net weight * kg	21 (+5.5)					

* The values in () for external dimensions and Net weight are the values for the optional ceiling panel. Specifications are subject to change without notice.

D1 TYPE 1-WAY CASSETTE Dimensions

- 1 Air intake grille
- 2 Air outlet
- 3 Refrigerant piping (liquid pipes)
Size 28 to 56: Ø6.35 (flared)
Size 73: Ø9.52 (flared)
- 4 Refrigerant piping (gas pipes)
Size 28 to 56: Ø12.7 (flared)
Size 73: Ø15.88 (flared)
- 5 Drain connection VP25 (outer Ø32)
- 6 Power supply entry
- 7 Discharge duct connection port (for descending ceiling)
- 8 Wireless remote control receiver (option)
- 9 Suspension mounting (4-12 x 30 slot)
- 10 Fresh air intake (Ø100)

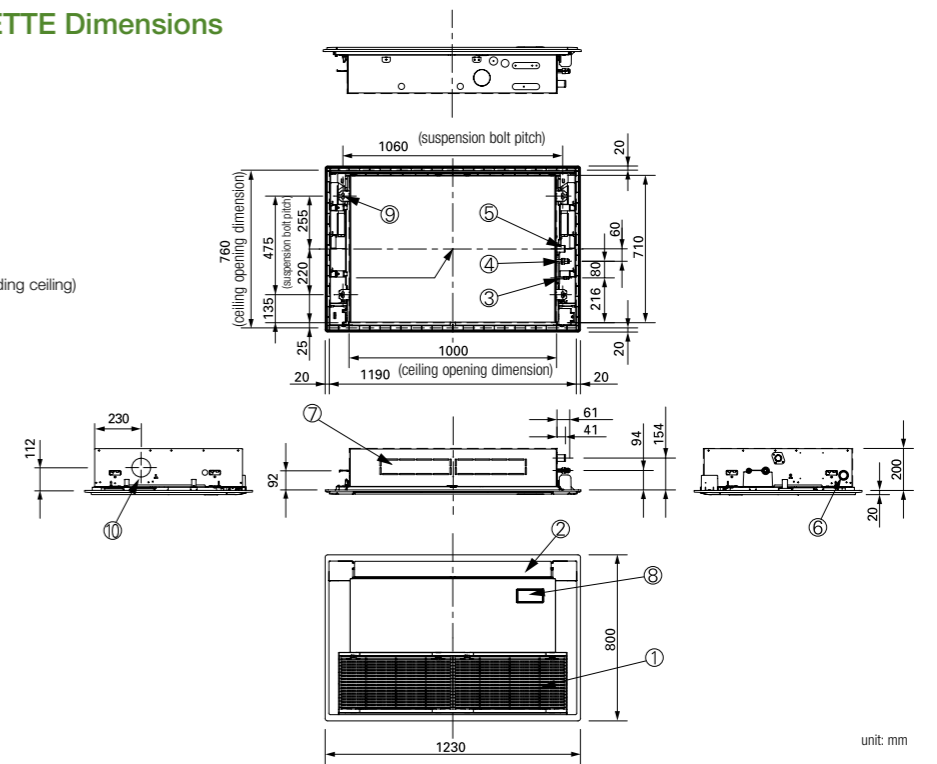

T2 TYPE Under Ceiling Ceiling mounted



Providing outstanding energy-saving performance and comfortable, long-distance air flow distribution, it's recommended for stores and schools.



Optional accessory

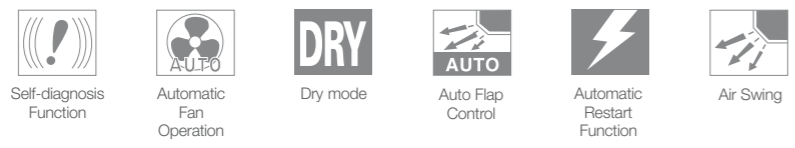
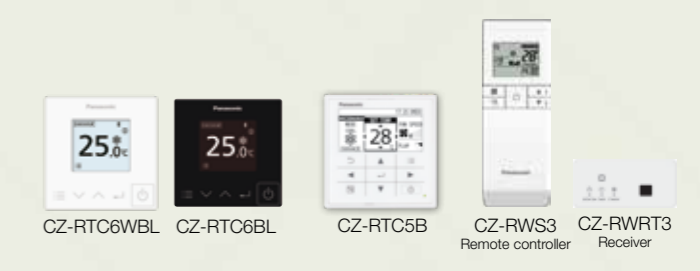

Technical focus

- Lower sound levels
- Standardised height and depth for all models
- Long and wide air distribution
- Easy to install and maintain
- Fresh air knockout

Compact Looking, Stylish, One-Motion Design

With its streamlined, one-motion form, the unit looks slim and compact when installed for a neat appearance in any room. When not operating, the louver closes to provide an elegant look while keeping the unit clean.



Energy-Saving Technology Delivering Top-Class Efficiency

Optimization of the shape of the casing and fan assures bigger air flow and higher efficiency. Energy-saving performance is top class in the industry.

Top Class Energy Saving

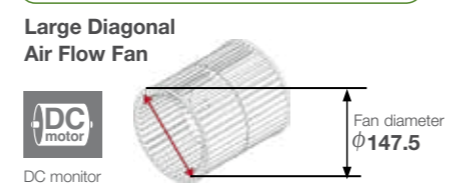

Comfortable, Long-Distance Air Flow Distribution

The shape of the outlet has been optimized to provide long-distance air flow distribution. Even in deep spaces, air flow reaches every corner for exceptionally comfortable air conditioning.

High Ceiling Setting <small>*Setting by remote control</small>	Air flow distance		
4.3m	12m	13m	13m

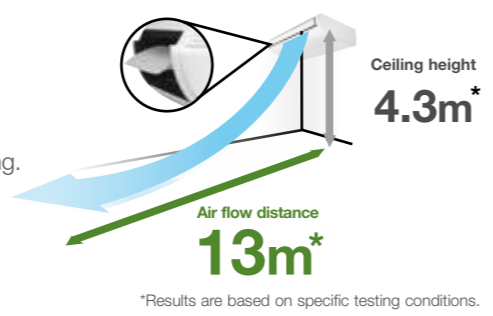

Multiple Piping Directions For Flexible Installation

The 5-directional drain pipe and 3-directional refrigerant pipe make installation much easier. And the neat fit with walls and ceilings assures more installation flexibility.

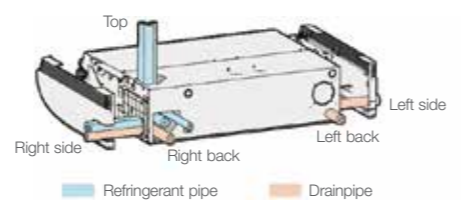

Model Name		S-36MT2E5A	S-45MT2E5A	S-56MT2E5A	S-73MT2E5A	S-106MT2E5A	S-140MT2E5A
Power source		220/230/240 V, 1 phase - 50/60 Hz					
Cooling capacity	kW	3.6	4.5	5.6	7.3	10.6	14.0
	BTU/h	12,300	15,400	19,100	24,900	36,200	47,800
Heating capacity	kW	4.2	5.0	6.3	8.0	11.4	16.0
	BTU/h	14,300	17,100	21,500	27,300	38,900	54,600
Power input	Cooling kW	0.035/0.035/0.035	0.040/0.040/0.040	0.040/0.040/0.040	0.055/0.055/0.055	0.080/0.080/0.080	0.100/0.100/0.100
	Heating kW	0.035/0.035/0.035	0.040/0.040/0.040	0.040/0.040/0.040	0.055/0.055/0.055	0.080/0.080/0.080	0.100/0.100/0.100
Running current	Cooling A	0.37/0.36/0.35	0.39/0.38/0.37	0.39/0.38/0.37	0.45/0.44/0.43	0.69/0.67/0.65	0.82/0.79/0.77
	Heating A	0.37/0.36/0.35	0.39/0.38/0.37	0.39/0.38/0.37	0.45/0.44/0.43	0.69/0.67/0.65	0.82/0.79/0.77
Fan	Type	Sirocco fan					
	Air flow rate (H/M/L) m³/h	840/720/630	900/750/630	900/750/630	1,260/1,080/930	1,800/1,500/1,380	1,920/1,680/1,440
	L/s	233/200/175	250/208/175	250/208/175	350/300/258	500/417/383	533/467/400
	Motor output kW	0.043	0.043	0.043	0.074	0.111	0.111
Sound power level (H/M/L) dB		54/50/48	55/51/48	55/51/48	57/53/51	60/55/54	62/58/55
Sound pressure level (H/M/L) dB(A)		36/32/30	37/33/30	37/33/30	39/35/33	42/37/36	44/40/37
Dimensions	H x W x D mm	235 x 960 x 690	235 x 960 x 690	235 x 960 x 690	235 x 1,275 x 690	235 x 1,590 x 690	235 x 1,590 x 690
	Liquid mm (inches)	Ø6.35 (Ø1/4)	Ø6.35 (Ø1/4)	Ø6.35 (Ø1/4)	Ø9.52 (Ø3/8)	Ø9.52 (Ø3/8)	Ø9.52 (Ø3/8)
	Gas mm (inches)	Ø12.7 (Ø1/2)	Ø12.7 (Ø1/2)	Ø12.7 (Ø1/2)	Ø15.88 (Ø5/8)	Ø15.88 (Ø5/8)	Ø15.88 (Ø5/8)
Pipe connections	Drain piping	VP-20					
Net weight kg		27	27	27	33	40	40

GLOBAL REMARKS	Rated conditions:	Cooling	Heating
	Indoor air temperature	27°C DB / 19°C WB	20°C DB
	Outdoor air temperature	35°C DB / 24°C WB	7°C DB / 6°C WB

Specifications are subject to change without notice.

T2 TYPE CEILING Dimensions

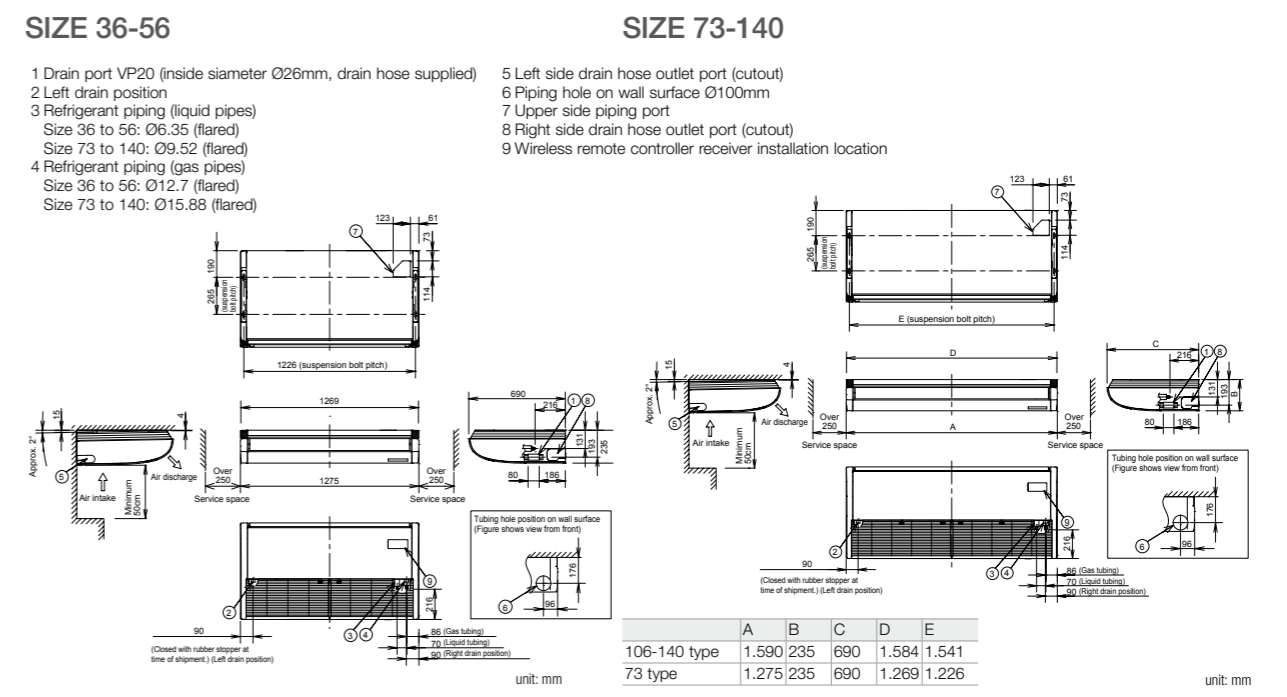

	A	B	C	D	E
106-140 type	1,590	235	690	1,584	1,541
73 type	1,275	235	690	1,269	1,226

G1 TYPE Floor Console

Compact and versatile, this system is capable of being installed in an area with limited space. It is a perfect solution for retrofit, replacing existing radiator panels.



Optional accessory

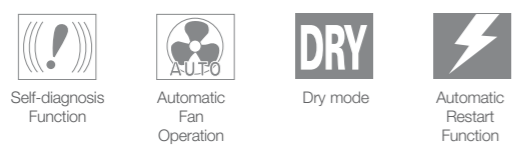
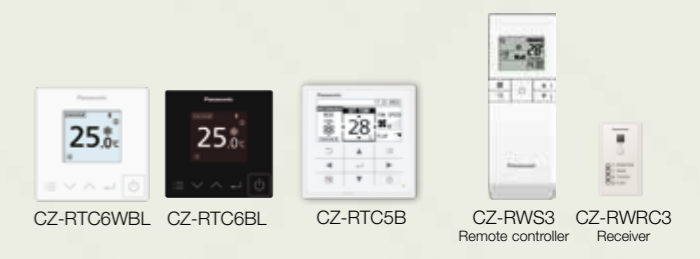

Technical focus

- Clean and stylish design with slim depth
- Modern matt white color panel
- Flexible and easy installation
- Washable air filter
- Quiet operation
- Dry mode to reduce humidity in rooms
- nanoe™ X with nano-technology, nano-sized electrostatic atomised water particles purify the air in the room

Stylish and simple

The stylish and compact unit profile, also used for residential market range, is easy to integrate into any design of building.



Flexible easy installation

Four different mounting styles possible: Exposed (floor or wall), semi-recessed and recessed

The compact unit can be installed within a limited space, such as under a window. Thus, it is a perfect solution to replace an existing boiler system radiator.

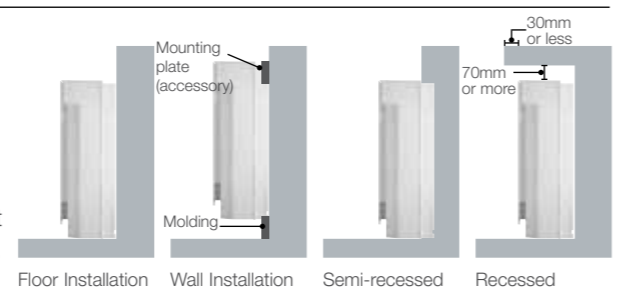

Functions for comfort

- Double Air Flow direction to maximize comfort
- Self-cleaning function

Self-cleaning function.

Self cleaning function can be pre-scheduled with remote controller, up to a maximum of 90 minutes following cooling/dry operation. Air flow will not blow directly at occupants during self-cleaning.

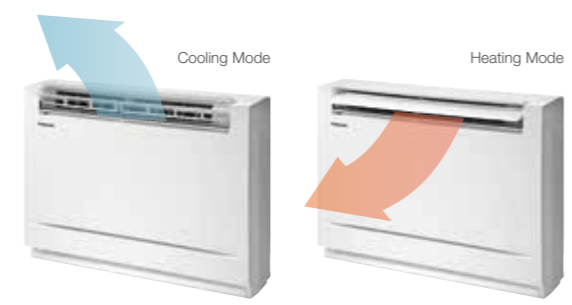

Model Name		S-22MG1E5N	S-28MG1E5N	S-36MG1E5N	S-45MG1E5N	S-56MG1E5N	
Power source		220/230/240 V, 1 phase - 50 / 60 Hz					
Cooling capacity	kW	2.2	2.8	3.6	4.5	5.6	
	BTU/h	7,500	9,600	12,300	15,400	19,100	
Heating capacity	kW	2.5	3.2	4.2	5.0	6.3	
	BTU/h	8,500	10,900	14,300	17,100	21,500	
Power input	Cooling kW	0.018/0.018/0.018	0.018/0.018/0.018	0.021/0.021/0.021	0.023/0.023/0.023	0.025/0.025/0.025	
	Heating kW	0.018/0.018/0.018	0.018/0.018/0.018	0.022/0.022/0.022	0.024/0.024/0.024	0.026/0.026/0.026	
Running current	Cooling A	0.18/0.18/0.18	0.18/0.18/0.18	0.21/0.21/0.21	0.23/0.23/0.23	0.25/0.25/0.25	
	Heating A	0.18/0.18/0.18	0.18/0.18/0.18	0.22/0.22/0.22	0.24/0.24/0.24	0.26/0.26/0.26	
Fan	Type	Cross flow		Cross flow	Cross flow	Cross flow	
	Air flow rate (H/M/L)	m³/h	552/450/360	552/450/360	582/492/360	630/540/390	720/570/390
	L/s		153/125/100	153/125/100	162/137/100	175/150/108	200/158/108
	Motor output kW		0.03	0.03	0.03	0.03	0.03
Sound power level (H/M/L)	dB	52/49/44	52/49/44	53/50/44	56/52/45	58/53/45	
Sound pressure level (H/M/L)	dB(A)	38/34/29	38/34/29	39/35/29	42/37/30	44/38/30	
Dimensions *	H x W x D	mm	600 x 750 x 207	600 x 750 x 207	600 x 750 x 207	600 x 750 x 207	600 x 750 x 207
	Liquid	mm (inches)	Ø6.35 (Ø1/4)	Ø6.35 (Ø1/4)	Ø6.35 (Ø1/4)	Ø6.35 (Ø1/4)	Ø6.35 (Ø1/4)
	Gas	mm (inches)	Ø12.7 (Ø1/2)	Ø12.7 (Ø1/2)	Ø12.7 (Ø1/2)	Ø12.7 (Ø1/2)	Ø12.7 (Ø1/2)
Pipe connections	Drain piping		VP-20	VP-20	VP-20	VP-20	
	Net weight *	kg	14	14	14	14	14

GLOBAL REMARKS	Rated conditions:	
	Cooling	Heating
	Indoor air temperature 27°C DB / 19°C WB	20°C DB
Outdoor air temperature 35°C DB / 24°C WB	7°C DB / 6°C WB	

Specifications are subject to change without notice. Infrared remote controller (CZ-RWS3) doesn't need receiver as an optional. Receiver is included in the unit shipment.

G1 TYPE FLOOR STANDING Dimensions

- 1 Refrigerant piping (liquid pipes): Ø6.35 (flared)
- 2 Refrigerant piping (gas pipes): Ø9.52 (flared)
- 3 Drain hose

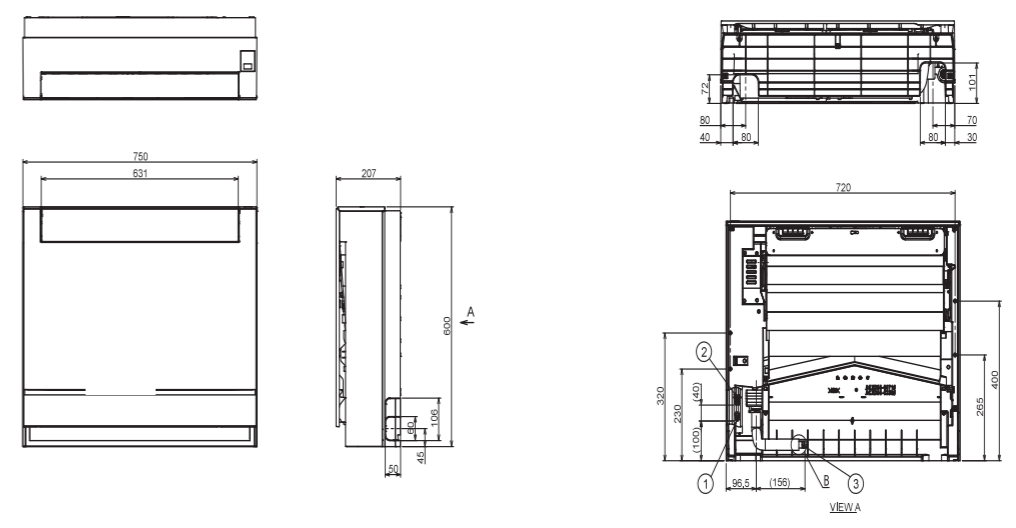

P1 TYPE Floor Standing

The compact floor standing P1 units are the ideal solution for providing perimeter air conditioning. A standard wired controller can be incorporated into the body of the unit.



Optional accessory



Technical focus

- Pipes can be connected to either side of the unit from the bottom or rear
- Easy to install
- Front panel opens fully for easy maintenance
- Removable air discharge grille gives flexible air flow

Effective perimeter air conditioning

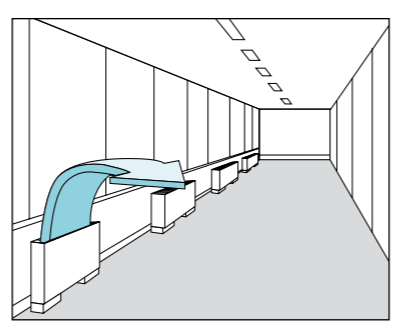

A wired remote control (CZ-RTC4/CZ-RTC5B) can be installed in the body

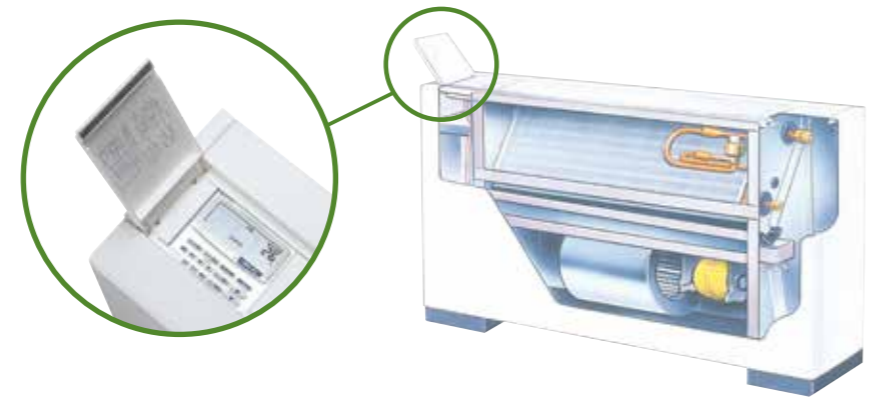

Model Name		S-22MP1E5	S-28MP1E5	S-36MP1E5	S-45MP1E5	S-56MP1E5	S-71MP1E5
Power source		220/230/240 V, 1 phase - 50/60 Hz					
Cooling capacity	kW	2.2	2.8	3.6	4.5	5.6	7.1
	BTU/h	7,500	9,600	12,000	15,000	19,000	24,000
Heating capacity	kW	2.5	3.2	4.2	5.0	6.3	8.0
	BTU/h	8,500	11,000	14,000	17,000	21,000	27,000
Power input	Cooling kW	0.051/0.056/0.061	0.051/0.056/0.061	0.079/0.085/0.091	0.116/0.126/0.136	0.116/0.126/0.136	0.150/0.160/0.170
	Heating kW	0.036/0.040/0.045	0.036/0.040/0.045	0.064/0.070/0.076	0.079/0.091/0.101	0.079/0.091/0.101	0.110/0.120/0.130
Running current	Cooling A	0.24/0.25/0.26	0.24/0.25/0.26	0.37/0.38/0.39	0.54/0.56/0.58	0.54/0.56/0.58	0.70/0.72/0.73
	Heating A	0.17/0.18/0.19	0.17/0.18/0.19	0.30/0.31/0.32	0.37/0.41/0.43	0.37/0.41/0.43	0.52/0.54/0.56
Fan	Type	Sirocco fan	Sirocco fan	Sirocco fan	Sirocco fan	Sirocco fan	Sirocco fan
	Air flow rate (H/M/L) m³/h	420/360/300	420/360/300	540/420/360	720/540/480	900/780/660	1,020/840/720
	L/s	117/100/83	117/100/83	150/117/100	200/150/133	250/217/183	283/233/200
	Motor output kW	0.01	0.01	0.02	0.02	0.03	0.06
Sound power level (H/M/L) dB		44/41/39	44/41/39	50/46/40	49/46/42	50/47/42	52/49/46
Sound pressure level (H/M/L) dB(A)		33/30/28	33/30/28	39/35/29	38/35/31	39/36/31	41/38/35
Dimensions H x W x D mm		615 x 1,065 x 230	615 x 1,065 x 230	615 x 1,065 x 230	615 x 1,380 x 230	615 x 1,380 x 230	615 x 1,380 x 230
	Liquid mm (inches)	Ø6.35 (Ø1/4)	Ø6.35 (Ø1/4)	Ø6.35 (Ø1/4)	Ø6.35 (Ø1/4)	Ø6.35 (Ø1/4)	Ø9.52 (Ø3/8)
Pipe connections Gas mm (inches)		Ø12.7 (Ø1/2)	Ø12.7 (Ø1/2)	Ø12.7 (Ø1/2)	Ø12.7 (Ø1/2)	Ø12.7 (Ø1/2)	Ø15.88 (Ø5/8)
	Drain piping	VP-20	VP-20	VP-20	VP-20	VP-20	VP-20
Net weight kg		29	29	29	39	39	39

GLOBAL REMARKS	Rated conditions:	
	Cooling	Heating
	Indoor air temperature 27°C DB / 19°C WB	20°C DB
Outdoor air temperature 35°C DB / 24°C WB	7°C DB / 6°C WB	

Specifications are subject to change without notice.

P1 TYPE FLOOR STANDING Dimensions

- 1 4 x Ø12 holes (for floor fixing)
- 2 Power supply outlet
- 3 Air filter
- 4 Refrigerant piping (liquid pipes)
- 5 Refrigerant piping (gas pipes)
- 6 Level adjustment bolt
- 7 Drain outlet VP20 (with vinyl hose)
- 8 Refrigerant piping connection port (bottom or rear)
- 9 Operation switch (remote controller RCS-SH80AG) mounting part
- 10 Electric equipment box
- 11 Accessory copper pipe for gas pipe connection

Indoor unit	A	B	C	Liquid pipes	Gas pipes
22 to 36 type	1,065	665	632	Ø6.35	Ø12.7
45 type					
56 type	1,380	980	947	Ø9.52	Ø15.88
71 type					

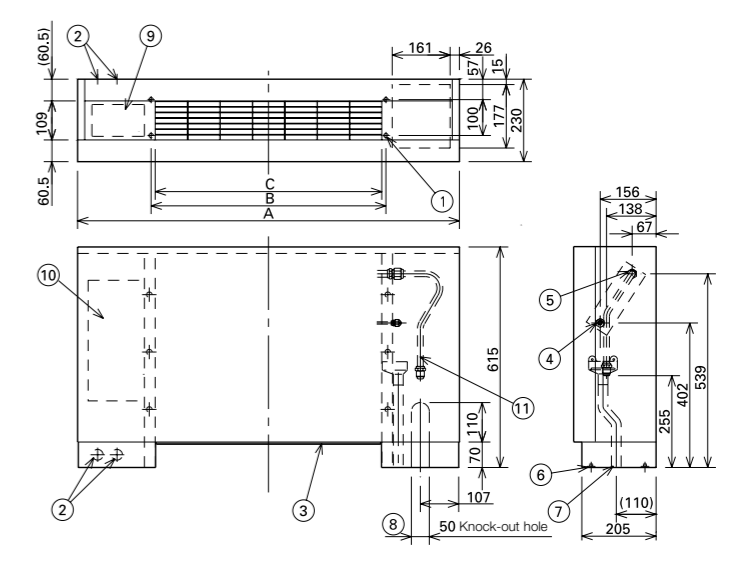

unit: mm

R1 TYPE Concealed Floor Standing

At just 229 mm deep, the R1 unit can be easily concealed in perimeter areas to provide powerful and effective air conditioning.



Optional accessory

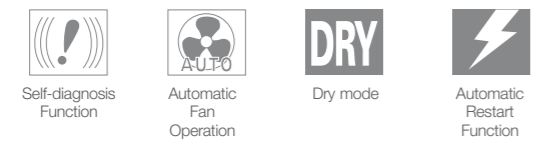
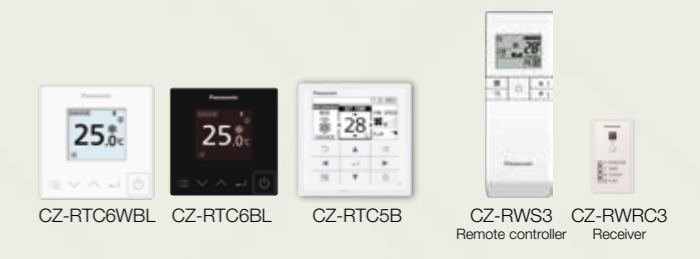

Technical focus

- Chassis unit for discrete customisable installation
- Complete with removable filters
- Pipes can be connected to the unit either from the bottom or rear
- Easy to install

Perimeter air conditioning with high interior quality

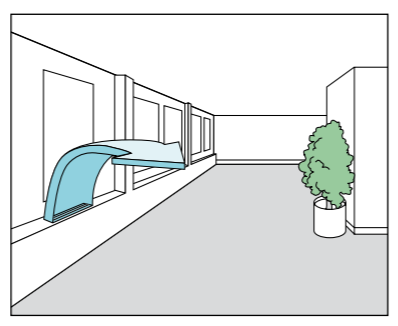

Model Name		S-22MR1E5	S-28MR1E5	S-36MR1E5	S-45MR1E5	S-56MR1E5	S-71MR1E5
Power source		220/230/240 V, 1 phase - 50/60 Hz					
Cooling capacity	kW	2.2	2.8	3.6	4.5	5.6	7.1
	BTU/h	7,500	9,600	12,000	15,000	19,000	24,000
Heating capacity	kW	2.5	3.2	4.2	5.0	6.3	8.0
	BTU/h	8,500	11,000	14,000	17,000	21,000	27,000
Power input	Cooling kW	0.051/0.056/0.061	0.051/0.056/0.061	0.079/0.085/0.091	0.116/0.126/0.136	0.116/0.126/0.136	0.150/0.160/0.170
	Heating kW	0.036/0.040/0.045	0.036/0.040/0.045	0.064/0.070/0.076	0.079/0.091/0.101	0.079/0.091/0.101	0.110/0.120/0.130
Running current	Cooling A	0.24/0.25/0.26	0.24/0.25/0.26	0.37/0.38/0.39	0.54/0.56/0.58	0.54/0.56/0.58	0.70/0.72/0.73
	Heating A	0.17/0.18/0.19	0.17/0.18/0.19	0.30/0.31/0.32	0.37/0.41/0.43	0.37/0.41/0.43	0.52/0.54/0.56
Fan	Type	Sirocco fan	Sirocco fan	Sirocco fan	Sirocco fan	Sirocco fan	Sirocco fan
	Air flow rate (H/M/L) m³/h	420/360/300	420/360/300	540/420/360	720/540/480	900/780/660	1,020/840/720
	L/s	117/100/183	117/100/183	150/117/100	200/150/133	250/217/183	283/233/200
	Motor output kW	0.01	0.01	0.02	0.02	0.03	0.06
Sound power level (H/M/L) dB		44/41/39	44/41/39	50/46/40	49/46/42	49/46/42	52/49/46
Sound pressure level (H/M/L) dB(A)		33/30/28	33/30/28	39/35/29	38/35/31	39/36/31	41/38/35
Dimensions	H x W x D mm	616 x 904 x 229	616 x 904 x 229	616 x 904 x 229	616 x 1,219 x 229	616 x 1,219 x 229	616 x 1,219 x 229
	Liquid mm (inches)	Ø6.35 (Ø1/4)	Ø6.35 (Ø1/4)	Ø6.35 (Ø1/4)	Ø6.35 (Ø1/4)	Ø6.35 (Ø1/4)	Ø9.52 (Ø3/8)
	Gas 410 A mm (inches)	Ø12.7 (Ø1/2)	Ø12.7 (Ø1/2)	Ø12.7 (Ø1/2)	Ø12.7 (Ø1/2)	Ø12.7 (Ø1/2)	Ø15.88 (Ø5/8)
Pipe connections	Drain piping	VP-20	VP-20	VP-20	VP-20	VP-20	VP-20
Net weight kg		21	21	21	28	28	28

GLOBAL REMARKS	Rated conditions:	
	Cooling	Heating
	Indoor air temperature 27°C DB / 19°C WB	20°C DB
Outdoor air temperature 35°C DB / 24°C WB	7°C DB / 6°C WB	

Specifications are subject to change without notice.

R1 TYPE CONCEALED FLOOR STANDING Dimensions

- 4 x Ø12 holes (for floor fixing)
- Electric equipment box
- Power supply outlet
- Air filter
- Discharge duct connection flange
- Refrigerant connection outlet (liquid pipes)
- Refrigerant connection outlet (gas pipes)
- Drain filter
- Drain pan
- Level adjustment bolt
- Drain outlet VP20 (with vinyl hose)

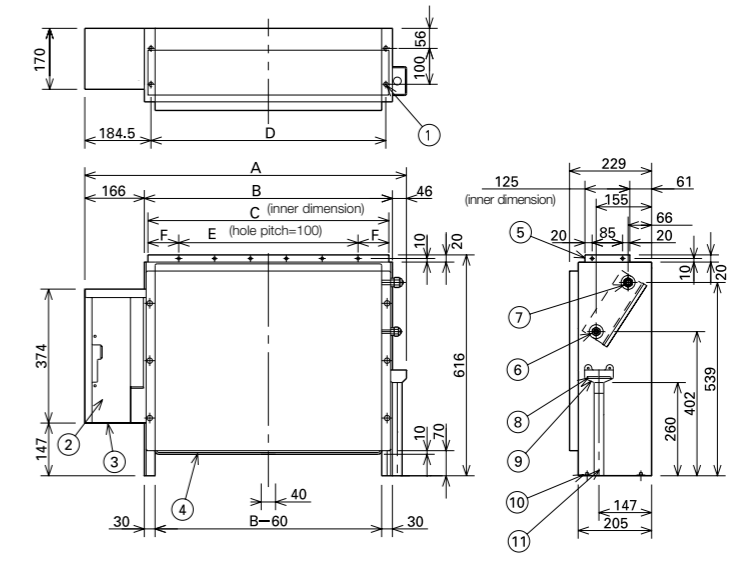

Indoor unit	A	B	C	D	E	F	Liquid pipes	Gas pipes
22 to 36 type	904	692	672	665	500	86	Ø6.35	Ø12.7
45 type								
56 type	1,219	1,007	1,002	980	900	51	Ø9.52	Ø15.88
71 type								

unit: mm

Smart Connectivity and Control Solutions

Panasonic offers a range of smart connectivity and control solutions for residential and commercial applications that allows you to conveniently manage and monitor air conditioning units in single or multiple locations from one mobile device.



For Residential

Panasonic Comfort Cloud

Personal Control Solutions Panasonic Comfort Cloud

Remotely manage and monitor multiple air conditioning units in your home

Easily control and access all features of the air conditioning units with smart centralised control.



CZ-CAPWFC1

Network adaptor. Available for all types of VRF indoor units.



**CZ-RTC6WBLW
CZ-RTC6BLW**

WLAN remote controller

*Available for particular types of VRF indoor units. Please consult with Panasonic sales engineers.

For Light Commercial

Panasonic Comfort Cloud VRF Smart Connectivity+

Cost effective Energy Management Solution



Multiple location control at your convenience with Comfort Cloud

Gain control of multiple zones and sites intuitively adjusting temperature by areas with differentiated user rights settings.

Indoor Air Quality (IAQ) and efficient energy usage with VRF Smart Connectivity+

- Ultimate cooling comfort with sensing technology and automatic IAQ control.
- Simplified Plug & Play installation with BMS connection for better energy consumption.

Wide Range of Smart Control Solutions for All Needs

Whether you need to control multiple sites, a single office, or your home, we offer a range of innovative smart control solutions for a variety of needs.



Panasonic Comfort Cloud

Intuitive and scalable air conditioning control solution using a personal mobile device.



VRF Smart Connectivity+

Offers efficient energy management with high indoor air quality (IAQ) control.



Panasonic AC Smart Cloud

Monitor and manage energy consumption of multiple location through a cloud computing system.

For Multiple Building Management

Panasonic AC Smart Cloud

Full Control of All Installations From A Single Internet Connection Panasonic AC Smart Cloud

Manage and monitor energy consumption patterns

Analyse energy usage, running time and optimise temperatures to reduce energy costs.

Centralised control solution with zero downtime

Receive real-time status updates to prevent breakdowns.

Flexible and scalable solution for expanding businesses and multi sites

Adaptable solutions that can easily be upgraded for new features, meet user demand and better IT management.

Panasonic Comfort Cloud

Control air conditioning units from wherever and whenever with your smartphone, by using Panasonic Comfort Cloud and WLAN smart adaptor. This scalable solution is ideal for one system, one site or multiple locations. Coupling the adaptor with the already feature rich systems, makes it an ideal solution for both residential and commercial applications.



Comfort Cloud

For Residential

Remotely manage and monitor air conditioning units from anywhere anytime.

For Light Commercial

Gain control of multiple zones and sites intuitively up to 200 indoor units.

Panasonic Comfort Cloud features

From 1 to 200 units

User can control up to 200 indoor units. 10 different sites, with up to 20 units / groups per site.



Multiple User

The Panasonic Comfort Cloud App allows multiuser access control. Restrict user access to specific units.



Easy Scheduling

Complex weekly scheduling made simple. Not only for one units, but across multiple sites and from a smartphone.

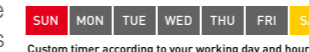

Error Codes

Error code notification through the App, provides early notification and allows for faster repair.



Application examples



Centralised control from reception.



Multiple location control for small businesses.

System configuration



WLAN smart adaptor specification

CZ-CAPWFC1	
Input Voltage	DC 12V (Supplied from indoor unit)
Power Consumption	Maximum 2.4W
Size [H x W x D]	120 x 70 x 25mm
Weight	190g (including communications lines)
Interface	Wireless LAN
Wireless LAN Standard	IEEE 802.11 b/g/n
Frequency range	2.4GHz band
Encryption	WPA2-PSK(TKIP/AES)
Operation range	0-55°C, 20 - 80RH%



Comfort Cloud App



Scan QR code to download free Panasonic Comfort Cloud App

Compatible Device and Browsers

1. IOS 9.0 or above
2. Android™ 4.4 or above

VRF Smart Connectivity+

Through thorough energy management, Panasonic's VRF Smart Connectivity+ is a completely new, state-of-the-art solution providing energy saving and comfort as well as simple installation, operation and running.



Dramatic reduction of OpEx with outstanding IAQ.
 3 built-in sensors: Temperature, RH and occupancy.
 ZigBee wireless sensors: CO₂ / temperature / RH%, window / door, ceiling / wall / water leakage.
 Relay Pack, Hotel Room Controller.



User-/owner-friendly.
 Colour touch screen.
 Simple and easy to use.
 22 languages.
 Easy-to-understand error description.



Ultimate customisation.
 Customisable colour background.
 Custom display/icons, messages.
 Programmable logic (also stand alone).
 Various controls and various external connection devices.



Easy design and Plug & Play to reduce CapEx.
 Simple Plug & Play VRF connection to Building Energy Management System (BEMS).
 Stand alone or BEMS connected.
 Easy installation of ZigBee sensors.

VRF Smart Connectivity+ offers efficient energy management and a new air conditioning control solution with high IAQ (indoor air quality).



Energy management system for rooms.

Each room is monitored by high-precision sensors, making it possible to make every room's temperature comfortable without wasting energy.

Management system for the entire building.

A Building Energy Management System (BEMS) can also be connected for Plug & Play centralised control of the building's entire energy consumption.

1 Quality air control

Optimum IAQ is realized using the CO₂ and humidity sensors. The interior environment remains comfortable, while heating and cooling costs are minimized. The CO₂ sensor can control ventilation systems, which contribute to improving the room's air quality.

2 Easy installation and integration

A remote controller is all that's required for occupancy control and optimum automatic indoor air quality (IAQ) control. Simple operation with a rented interface further contributes to increased energy efficiency and productivity for reduced capital expenditure (CapEx) and operating expense (OpEx).

3 Other equipment control

One room controller manages various devices including lighting and the blinds. A ventilation system and other external connection devices can be connected by using HRC or SE8350 so that various control is possible with this controller alone, even without BMS.

VRF Smart Connectivity+: SER8150.

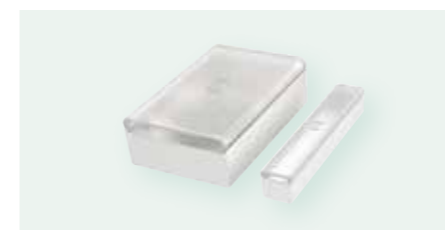

Door/window sensor.
 Door and window contact detection sensor to monitor opening and closing.



Wall/ceiling motion/temperature/humidity sensor.
 Wall and ceiling sensor to detect the presence or absence of occupants.



CO₂ /temperature/humidity sensor.
 Monitor indoor air quality, review data on interfacing devices, and control fresh air inside customisable zones.



Water leakage sensor.
 Two sensing pads under the body activate when water is present between the two pads. Detecting the water, the sensor reports the event to the controller (and BEMS).



Hotel Room Controller (HRC).
 The Hotel Room Controller controls connected guest room devices and aggregates data, making it visible to guest room and property management systems.

Energy management system for rooms

By installing a wall/ceiling motion temperature sensor, window/door sensor, and CO₂ sensor in the room, ideal, waste-free air conditioning is achieved.

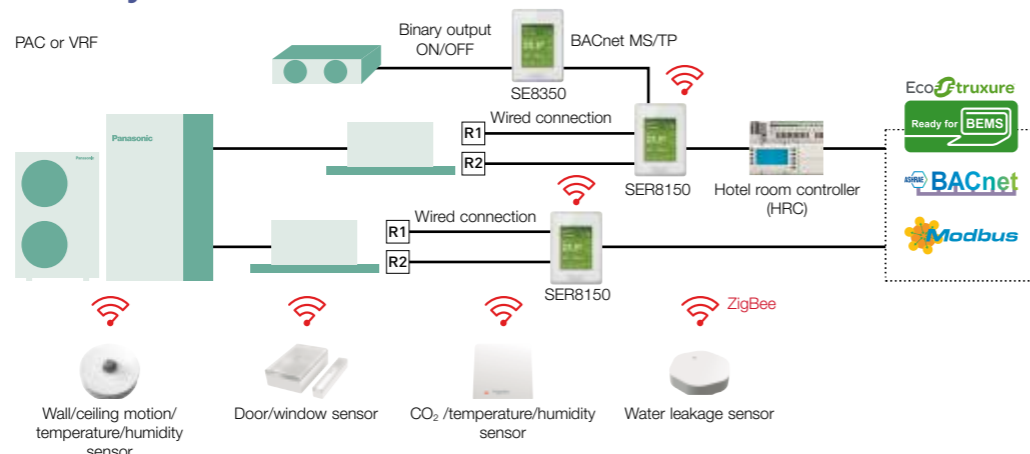

Sensing and control technology

Using sensors from Schneider Electric, high-quality occupancy control and automatic IAQ control are realised. The sensors detect the presence or absence of occupants, and the opening and closing of doors and windows to achieve the most efficient energy management for exceptional air-conditioned comfort. Flexible installation is possible to match different applications and building features such as walls, ceilings and proximity to doors and windows. No wiring means extra installation versatility.

Batteries last for up to five years (10-year battery for CO₂ sensor) and are easy to install and replace.

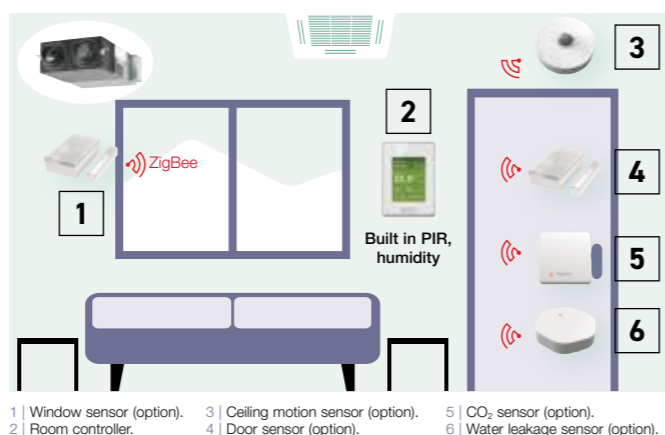

1 | Window sensor (option). 2 | Room controller. 3 | Ceiling motion sensor (option). 4 | Door sensor (option). 5 | CO₂ sensor (option). 6 | Water leakage sensor (option).

Pana Net Con, RH, No PIR, SE Brand, R1R2. SER8150R0B1194



Pana Net Con, RH, PIR, SE Brand, R1R2. SER8150R5B1194



Wireless ZigBee® Pro communication card. VCM8000V5094P

Hotel room expansion module 14 indoor units. HRCEP14R



Hotel room controller 28 indoor units. HRCBP28R



Hotel room controller w/display 42 indoor units. HRCPDG42R



* Those accessories require system integrator support on site.

Sensor with room CO₂, temperature and humidity. SED-CO2-G-5045



Sensor with room temperature and humidity. SED-TRH-G-5045



Door/window sensor. SED-WDC-G-5045

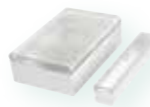

Wall/ceiling motion/temperature/humidity sensor. SED-MTH-G-5045



Water leakage sensor. SED-WLS-G-5045



Cover frame. Silver. FAS-00



Cover frame. White. FAS-01



Cover frame. Glossy translucent white. FAS-03



Cover frame. Light tan wood. FAS-05



Cover frame. Dark brown wood. FAS-06



Cover frame. Dark black wood. FAS-07



Cover frame. Brushed steel finish. FAS-10



Up to 5 year battery life (batteries included). Battery life of CO₂ sensor up to 10 years. Battery level data point.

Smart management solutions



1 Hotels

Room key card or key cardless solutions for hotels. The SER8150 and ZigBee sensor automatic detection function offer optimal air conditioning regardless of whether there is a hotel room key or not. Sensors detect the presence or absence of occupants and the opening and closing of doors and windows for the optimum air-conditioned environment guests expect. Automatic control ensures the most efficient operation when guests are away or when windows are open. This contributes to an appreciable reduction in operation costs.



2 Small and medium offices

CO₂ sensors (option) and humidity sensors. CO₂ sensors (option) take measurements in units of ppm, and humidity sensors enable fine air quality control. This creates the most comfortable space for occupants while contributing to improved employee satisfaction.



3 Super markets

Humidity sensors. Humidity sensors enable automatic dehumidification for the optimum IAQ regardless of climatic conditions. This creates an even more comfortable environment for customers, employees, and products themselves.

Innovative and unrivalled advantages



Colour and design to match office interiors.
Colour combinations and design can be set to match different facilities.



Easy-to-understand error description.
Error description during an emergency is easy to understand, enabling staff to respond quickly.

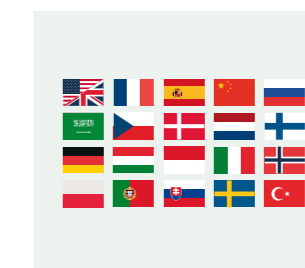

Customisation in 22 languages possible.
The display can be customised to match the native languages of guests to enable smooth, stress-free communication for hospitality at its finest.



Programmable logic.
Full customisation of remote controller logic possible, and updating to match conditions.



Panasonic AC Smart Cloud

With Panasonic AC Smart Cloud, have your business under control, and start saving!



Key functions and uniqueness

Multi site monitoring.

- It doesn't matter how many sites you have, easy to manage, operate, compare sites, locations, rooms.



Schedule setting.

- Yearly / weekly / holiday timer setting as you want



Powerful statistics for energy savings.

- Power consumption, capacity, efficiency level can be compared with different parameters (Yearly / monthly / weekly / daily bases)



Maintenance notification.

- Error notification by email and with floor layout
- Maintenance notification of PAC / VRF outdoor units
- Remote service checker function



User customisation¹.

Site administrator can create users as desired and assign customised profiles.

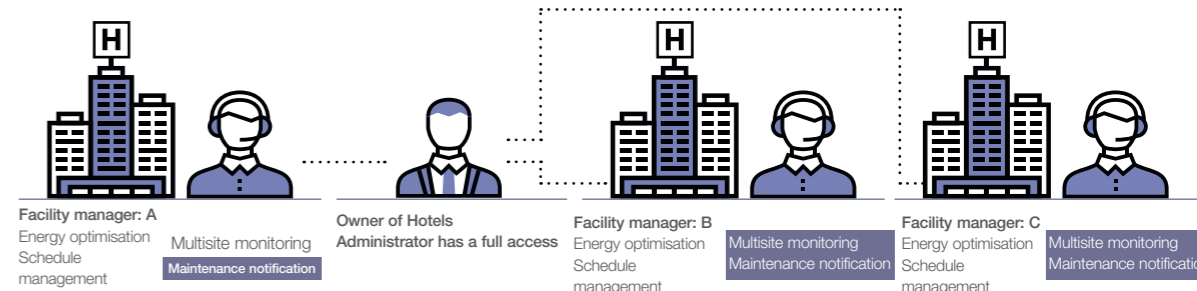

Flexible and scalable solution

- Energy saving
- Zero downtime
- Site(s) management

Centralise control of your business premises, from wherever you are, 24/7/365.

It doesn't matter how many sites you have, or where they are!

The AC Smart Cloud system from Panasonic allows you to have complete control of all your installations, from your tablet or from your computer.

In a simple click, all your units from several locations, receive status updates in real-time of all your installations, preventing breakdowns and optimising costs.

Flexible solution for your business.

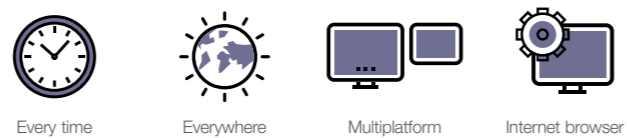

Scalable solution for your business.



* Customised to meet user demand / Continuous upgrades: new functions and product introductions / IT smart management.

Panasonic AC Smart Cloud offers continuous improvement always thinking about users

New e-CUT function

E-CUT functions are newly available in Panasonic AC Smart Cloud.

5 energy saving settings reduces automatically its energy consumption.

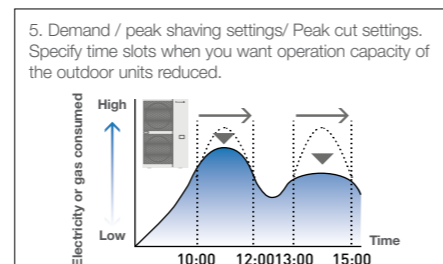
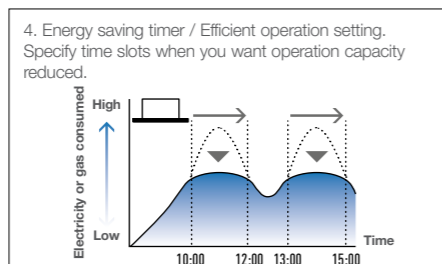
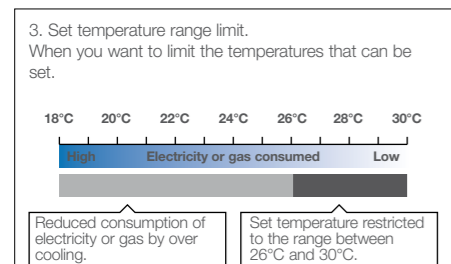
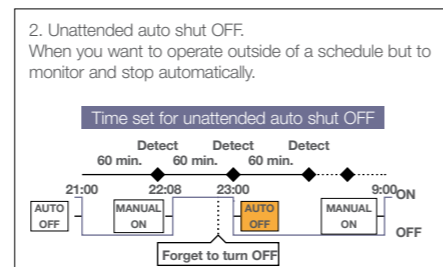
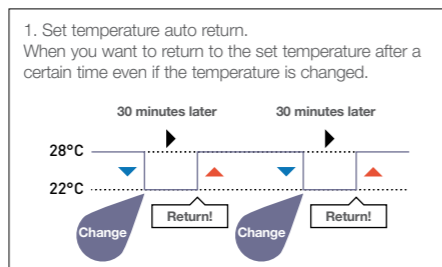

Main functions per user type

Function / Main Tab	Sub-Tab	Basic type (Eg.: Owners, facility managers)	Professional type (Eg.: Installers, maintenance companies)
AC setting	I / U / O / U operation details	✓	✓
	Cloud adapter (CZ-CFUSCC1) details	✓	✓
	AC maintenance	✓	✓
	Map view	✓	✓
Energy saving function	NEW e-CUT	✓	✓
	Yearly, weekly schedule setting / view	✓	✓
Schedule	Power consumption	✓	✓
	Capacity	✓	✓
Powerful statistics	Efficiency ranking	✓	✓

Function / Main Tab	Sub-Tab	Basic type (Eg.: Owners, facility managers)	Professional type (Eg.: Installers, maintenance companies)
Maintenance function	Notification overview / details	✓	✓
	Maintenance settings	✓	✓
	Map view	✓	✓
	Remote service checker	✓	✓
User account ¹	New / update user registration	✓	✓
	Distribution group overview / details	✓	✓
System setting	Cut OFF request	✓	✓
	Map editor	✓	✓

Remote service checker function

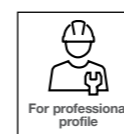

Zero down time

- Quick analysis & response
- Time & Cost saving for service maintenance task

Recording service checker parameters from wherever you are!

- Data duration: Maximum 120 minutes
- Data frequency: 10 – 90 seconds
- Mode selection: With test run or Without test run
- Count down schedule setting available

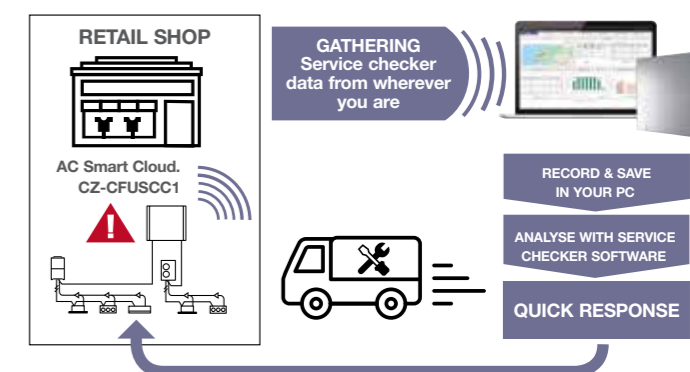

Panasonic AC Smart Cloud parts lists

¹ Cloud service fee is additionally required. Please contact an authorised Panasonic dealer.

CZ-CFUSCC1 AC Smart Cloud communication adaptor. Up to 128 groups. 128 units control

¹ Please contact an authorized Panasonic dealer.

Controllers

A wide variety of control options to meet the requirements of different applications.

Remote Temperature Sensor

CZ-CSRC3



- This is a remote sensor which can be used with indoor units. Use it to detect the room temperature when no remote controller sensor or body sensor is used (connection to a system without a remote controller is possible).
- For joint use with a remote control switch, use the remote control switch as main remote controller.

Operation system	Individual control systems			
Requirements	Simplified high-spec operation	High-spec operation	Normal operation	Operation from anywhere in the room
External appearance				
Type, model name	Simplified high-spec Wired Remote Controller with Bluetooth CZ-RTC6WBL/CZ-RTC6WBLW (White) CZ-RTC6BL/CZ-RTC6BLW (Black) *Available for particular types of VRF indoor units	High-spec Wired Remote Controller CZ-RTC5B	Timer Remote Controller (Wired) CZ-RTC4	Wireless Remote Controller Controller: CZ-RWS3 Receiver: CZ-RWRU3 CZ-RWRL3 CZ-RWRD3 CZ-RWRT3 CZ-RWRC3
Built-in thermostat	●	●	●	—
nanoe™ X on/off control *not applies to Floor Console	●	●	—	●
ECONAVI ON/OFF control	●	●	●	●
Number of indoor units which can be controlled	1 group, 8 units	1 group, 8 units	1 group, 8 units	1 group, 8 units
Use limitations	· Up to 1 controller can be connected per group	· Up to 2 controllers can be connected per group (When using ECONAVI sensor, only one remote controller is possible to connect at indoor unit)	· Up to 2 controllers can be connected per group (When using ECONAVI sensor, only one remote controller is possible to connect at indoor unit)	· Up to 2 controllers can be connected per group.
Function ON/OFF	●	●	●	●
Mode setting	●	●	●	●
Fan speed setting	●	●	●	●
Temperature setting	●	●	●	●
Air flow direction	●	●	●	●
Permit/Prohibit switching	—	—	—	—
Weekly program *	●	●	●	—

All specifications are subject to change without notice.
*(CZ-RTC6WBL/CZ-RTC6WBLW with H&C Control App)

Centralised control systems			SMART CONTROL SYSTEMS		
Operation with various functions from a central location	Only ON/OFF operation from a central location	Simplified load distribution ratio (LDR) for each tenant 10.4 in. touch screen panel color LCD	Connection with 3rd Party Controller	Cloud connectivity, operation from anywhere	Schneider Electric room controller
System Controller	ON/OFF Controller	Intelligent Controller	CZ-CAPDC2	WLAN Smart Adaptor Comfort Cloud App	VRF smart connectivity+
CZ-64ESMC3	CZ-ANC3	CZ-256ESMC3 (CZ-CFUNC2)		CZ-CAPWFC1	SER8150 (room controller)
—	—	—	CZ-CAPC3	—	●
—	—	—		—	—
●	—	●	CZ-CAPBC2	●	—
64 groups, max. 64 units	16 groups, max. 64 units	64 units x 16 systems, max. 256 units		1 adaptor : 1 group, 8 units. Multiple adaptors for each indoor units : 200 units(10 location x 20 units)	1 group, 8 units
· Up to 10 controllers, can be connected to one system. · Main unit/sub unit (1 main unit + 1 sub unit) connection is possible. · Use without remote controller is possible.	· Up to 8 controllers (4 main units + 4 sub units) can be connected to one system. · Use without remote controller is impossible.	· A communication adaptor (CZ-CFUNC2) must be installed for three or more links.	CZ-CFUNC2	· Mobile device, free App and internet router is required separately. · Wired remote controller (master) required.	· Up to 1 controller can be connected per IDU · Wired to R1/R2 · VRF and PAC(S-link) model only
●	●	●		●	●
●	—	●	CZ-CLNC2	●	●
●	—	●		●	●
●	—	●		●	●
●	—	●		●	●
●	●	●		—	—
●	—	●		●	—

Simplified wired remote controller (CZ-RTC6WBL/CZ-RTC6BL)



Dimensions
H 86 x W 86 x D 25mm

High-spec wired remote controller (CZ-RTC5B)



Dimensions
H 120 x W 120 x D 16 mm

	CZ-RTC6WBL/ CZ-RTC6BL	CZ-RTC6BL + H&C CONTROL APP	CZ-RTC5B
Energy Saving			
ECONAVI on/off	●	●	●
Temperature Auto Return	—	●*1	●
Temperature Setting range	—	●*1	●
Auto Shutoff	—	●*1	●
Schedule peak cut	—	●*1	●
Repeat off timer	—	●*1	●
Basic Operation			
Individual Louver Control(Lock individual flap for 4-WAY cassette)	—	●*1	●
ON/OFF timer	—	●*1	●
Weekly timer	—	●*1	●
Filter information	●*2	●*1*2	●*2
Outing function	●	●	●
Quiet operation mode	—	●*1*2	●*2
Power consumption monitor	—	●*1*2	●*2
Energy saving	—	●*1*2	●*2
initial settings	—	—	●
Ventilation	—	●*1	●
nanoe™ X	●*2	●*1*2	●*2
Maintenance Function			
Outdoor unit error data	—	—	—
Service Contact address	—	●*1	—
RC setting mode	●	●	●
Test run	●	●	●
Sensor information	●*2	●*2	●*2
Service check	●	●	●
Simple/Detailed Settings	●	●	●
Auto address	●	●*3	●
Initial Settings			
Rotation operation	—	●*1	●
Backup operation	—	●*1	●
Support operation	—	●*1	●

*1 Only with H&C Control App *2 Subject to the connected model *3 Only with remote controller operation
Note: Product images not to scale.

Individual Control Systems

Control contents	Part name, model No.	Quantity
Standard Control <ul style="list-style-type: none"> Control of the various operations of the indoor unit by wired or wireless remote controller. Cooling or heating mode of the outdoor unit is decided by the first priority of the remote controller. Switching between remote controller sensor and body sensor is possible. 	Wired remote controller CZ-RTC4,CZ-RTC5B,CZ-RTC6WBL/CZ-RTC6BL Wireless remote controller + Receiver CZ-RWS3 (Wall Mounted/ Mini Cassette) CZ-RWS3 + CZ-RWRL3 (4-WAY Cassette) CZ-RWS3 + CZ-RWRL3 (2-WAY Cassette) CZ-RWS3 + CZ-RWRD3 (1-WAY Cassette) CZ-RWS3 + CZ-RWRT3 (Ceiling Mounted) CZ-RWS3 + CZ-RWRC3 (All split type)	1 unit each
(1) Group control <ul style="list-style-type: none"> Batch remote control on all indoor units. Operation of all indoor units in the same mode. Up to 8 units can be connected. The sensor is the body sensor, and thermostat ON/OFF setting in regard to the temperature set by the remote controller is possible for each indoor unit. 	Wired remote controller CZ-RTC4,CZ-RTC5B,CZ-RTC6WBL/CZ-RTC6BL Wireless remote controller + Receiver CZ-RWS3 (Wall Mounted/ Mini Cassette) CZ-RWS3 + CZ-RWRL3 (4-WAY Cassette) CZ-RWS3 + CZ-RWRL3 (2-WAY Cassette) CZ-RWS3 + CZ-RWRD3 (1-WAY Cassette) CZ-RWS3 + CZ-RWRT3 (Ceiling Mounted) CZ-RWS3 + CZ-RWRC3 (All split type)	As required
(2) Main/sub remote control <ul style="list-style-type: none"> Max 2 remote controllers per indoor unit. (Main remote controller can be connected) The button pressed last has priority. Timer setting is possible even with the sub remote controller. (When using ECONAVI sensor, only one remote controller is possible to connect at indoor unit) 	Wired remote controller CZ-RTC4,CZ-RTC5B,CZ-RTC6WBL/CZ-RTC6BL Wireless remote controller + Receiver CZ-RWS3 (Wall Mounted/ Mini Cassette) CZ-RWS3 + CZ-RWRL3 (4-WAY Cassette) CZ-RWS3 + CZ-RWRL3 (2-WAY Cassette) CZ-RWS3 + CZ-RWRD3 (1-WAY Cassette) CZ-RWS3 + CZ-RWRT3 (Ceiling Mounted) CZ-RWS3 + CZ-RWRC3 (All split type)	As required

SYSTEM EXAMPLE FSV

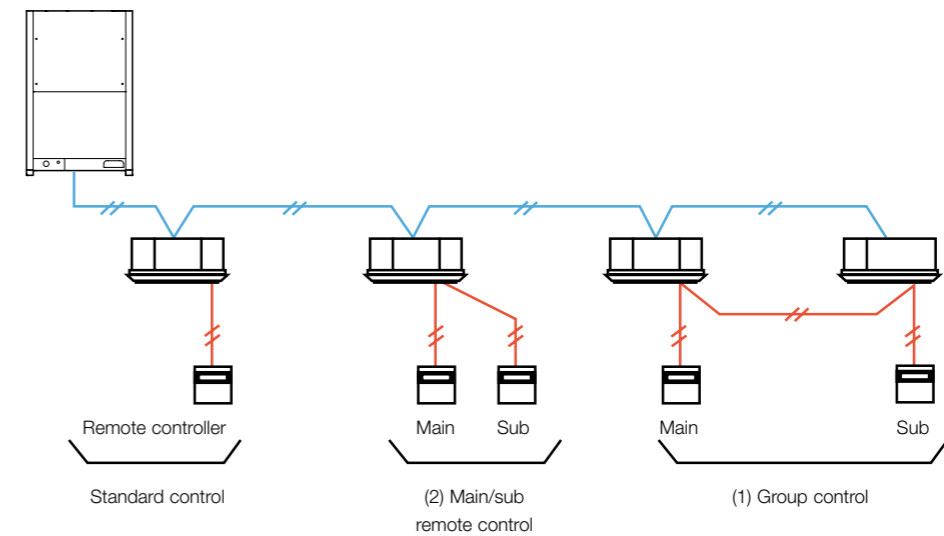

NOTE: Connectable number of controllers, controller combination, connectable indoor units, remote control maximum wiring length are different between the controller. Please confirm the installation instructions of controller or consult with Panasonic service center.

Timer remote controller (CZ-RTC4)



Dimensions
H 120 x W 120 x D 20 mm

Basic remote controller ON/OFF

- Operation mode changeover (Cooling, Heating, Dry, Auto, Fan).
- Temperature setting (Cooling/Dry: 18-30 deg Heating: 16-30 deg).
- Fan speed setting H/ M/ L and Auto.
- Air flow direction adjustment.
- ECONAVI on/ off*

Time Function 24 hours real time clock

- Day of the week indicator.**Weekly Programme Function**
- A maximum of 6 settings/day and 42 settings/week can be programmed.

Outing Function

- This function can prevent the room temperature from dropping or rising when the occupants are out for a long time.

Sleeping Function

- This function controls the room temperature for comfortable sleeping.

Max. 8 indoor units can be controlled from one remote controller

Remote control by main remote controller and sub controller is possible

Max. 2 remote controllers (main remote controller and sub controller) can be installed for one indoor unit.

* Depending on the model, some menus cannot be used.

Wireless remote controller



4-Way Cassette
CZ-RWS3 + CZ-RWRU3



Mini Cassette
CZ-RWS3 + CZ-RWRY3



2-WAY Cassette
CZ-RWS3 + CZ-RWRL3



1-WAY Cassette
CZ-RWS3 + CZ-RWRD3



Ceiling Mounted
CZ-RWS3 + CZ-RWRT3



For all indoor units
CZ-RWS3 + CZ-RWRC3



Wall
CZ-RWS3

Remote control by main remote controller and sub controller is possible

- Max. 2 remote controllers (main remote controller and sub controller) can be installed for one indoor unit.

When CZ-RWS3 is used, wireless control becomes possible for all indoor units

- When a separate receiver is set up in a different room, control from that room also becomes possible.
- Automatic operation by means of the emergency operation button is possible even when the remote controller has been lost or the batteries have been exhausted.

In addition, there are other functions such as temperature setting, operation switching, airflow direction/fan speed setting, etc

Ventilation independent operation is possible

When commercial ventilation fans or heat-exchange ventilation fans have been installed, they can be operated with this remote control (interlocked operation with the indoor unit or independent ventilation ON/OFF).

Centralised Control Systems

System controller (CZ-64ESMC3)

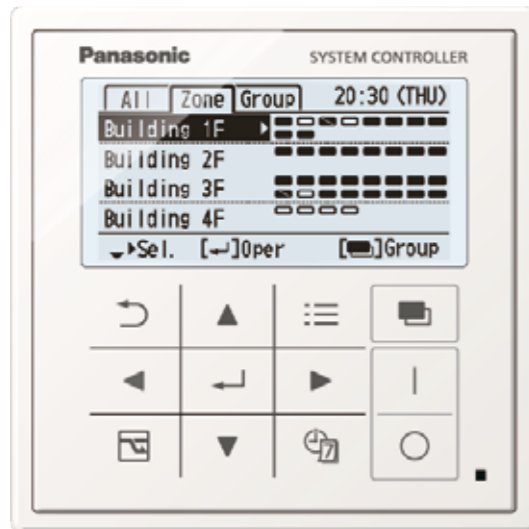

Dimensions
H 120 x W 120 x D 16 + 52
(embedding dimension mm)

Power supply: AC 100 to 240 V
I/O part:
Remote input part (effective voltage:DC24V) All operation, All stop, Demand 1, Demand 2
Remote output part (non voltage contact) Operation, Alarm (external power supply within DC 30V, max 0.5A)
Total wiring length : 1 km

Individual control is possible for max 64 groups, 64 indoor units.

- Control of 64 indoor units divided into 4 zones. (One zone can have up to 16 groups, and one group can have up to 8 units.)
- Control is possible for ON/OFF, operation mode, fan speed, air flow direction, operation monitoring, alarm monitoring, ventilation, remote controller local operation prohibition, etc.

Prohibition setting for Remote controller operation

Setting mode	ON/OFF	Mode	Temperature	Fan speed	Flap
Permit	●	●	●	●	●
Prohibit 1	—	●	●	●	●
Prohibit 2	—	—	—	●	●
Prohibit 3	●	—	—	●	●
Prohibit 4	●	—	●	●	●

In case of joint use with a wireless remote controller, there are limitations for the control mode. Please use only with setting "Permit" and "Prohibit1 (prohibition for ON/OFF)".

*Contents for Prohibit 1~4 can be modified.
□ : Operation from the remote controller is possible.
— : Operation from the remote controller is prohibited.

- Joint use with a remote controller, an intelligent controller, etc. is possible
(The maximum number of connectable system controllers is 10, including other central controllers on the same circuit.)
(In case of joint use with a wireless remote controller, there are limitations for the control mode. Please use only with setting "Permit" and "Prohibit1 (prohibition for ON/OFF)".)
- Control of systems without a remote controller and of main/sub systems (a total of up to 2 units) is possible
- Weekly timer function
 - 8 programs per day (with ON/OFF/Mode/Temperature/Central control setting items) for 1week (7days) can be set.
 - Special holiday setting can ignore the timer operation temporary by keeping original timer setting. (Special holiday setting can be removed by same setting display.)
- 5 types of Energy saving function
Set temperature automatic return / Set temperature range limitation / Off remind / Off timer operation / Demand control timer

- A control mode corresponding to the use condition can be selected from 10 patterns

A : Operation mode: Central control mode or remote control mode can be selected

Central control mode: The system controller is used as centralised control device. (Setting from a remote controller can be prohibited by prohibiting local operation from the system controller.)

Remote control mode: The system controller is used as a remote controller. (Setting from the system controller can be prohibited by prohibiting local operation from another central control unit.)

B : Controlled unit number mode: All mode or zone 1, 2, 3, 4 mode can be selected

All mode: All, zone, or group unit can be selected.

Zone 1, 2, 3, 4 mode: Setting is possible only for the indoor units of zone 1, 2, 3, or 4.

Connection example		A Operation mode	
		Central control mode	Remote control mode
B Controlled unit number mode	All mode	All central control Example 1	All remote control
	Zone 1 mode	Zone 1 central control Example 2	Zone 1 remote control
	Zone 2 mode	Zone 2 central control Example 3	Zone 2 remote control Example 3
	Zone 3 mode	Zone 3 central control Example 4	Zone 3 remote control
	Zone 4 mode	Zone 4 central control Example 5	Zone 4 remote control Example 5

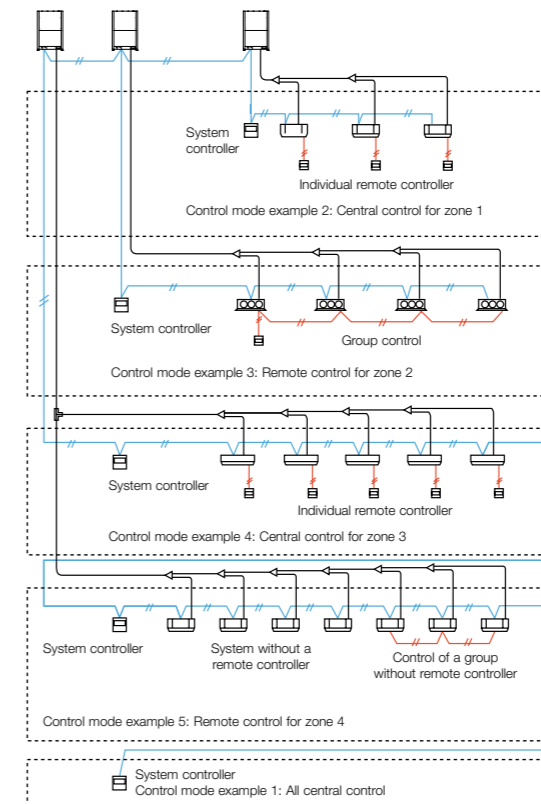

ON/OFF controller (CZ-ANC3)

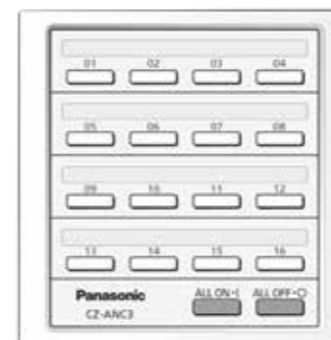

Dimensions
H 121 x W 122 x D 14 + 52
(embedding dimension mm)

Power supply: AC 100 to 240 V
I/O part:
Remote input (effective voltage: within DC 24 V): All ON/OFF
Remote output (allowable voltage: within DC 30 V): All ON, All alarm

- 16 groups of indoor units can be controlled.
- Collective control and individual group (unit) control can also be performed.
- Up to 8 ON/OFF controller (4 main, 4 sub) can be installed in one link system.
- The operation status can be determined immediately.

Intelligent controller (CZ-256ESMC3)



Touch panel

Dimensions
H 240 x W 280 x D 85 mm
Power supply AC 100 to 240 V (50/60 Hz)
LCD: 10.4 in. TFT, XGA(1024 x 768), LED backlight

Product Features

- 10.4 in., Large, easy-to-use color LCD
 - With smartphone like operations, such as swiping and flicking
- Enhanced energy-saving control functions
 - Packed with demand functions
 - Set temperature auto return settings, Auto shutoff, Set temperature range limit settings
- Energy Visualization
 - Displays electricity & gas usage distribution
 - Supports energy-saving plans with graph display function

New Features

- Max 256 indoor unit [4 links x 64 units] can be controlled. In case of three or more systems [more than 128 units], a communication adaptor CZ-CFUNC2 must be installed for three or more links.
- Operation is possible as batch, in zone units, and in group units.
- ON/OFF, operation mode setting, temperature setting, for fan speed setting, air flow direction setting (when used without a remote controller) and remote controller local operation prohibition [prohibition 1,2,3,4] can be done
- Graph display [trends, comparisons]
- ECONAVI ON/OFF

- Outdoor unit quiet operation ON/OFF
- Energy-saving Functions
- Event control [such as equipment linkage]
- Limitation contents for prohibited operation

Prohibition means limitation of the operation contents from the remote controller. It is also possible to change the prohibition items.

Limitation contents (Limitations can be user defined)

- Individual There is no limitation for the operation of the remote controller. However, the contents will be changed to the contents of the controller operated last. (Last-pressed priority.)
- Prohibition 1 The remote controller cannot be used for ON/OFF. (All other operations are possible from the remote controller.)
- Prohibition 2 The remote controller cannot be used for ON/OFF, operation mode change and temperature setting. (All other operations are possible from the remote controller.)
- Prohibition 3 The remote controller cannot be used for operation mode change and temperature setting. (All other operations are possible from the remote controller.)
- Prohibition 4 The remote controller cannot be used for operation mode change. (All other operations are possible from the remote controller.)

Remote Control

The LAN terminal on this unit enables you to connect it to a network. Connecting to internet will enable you to operate the unit and check the status using a PC from remote location.

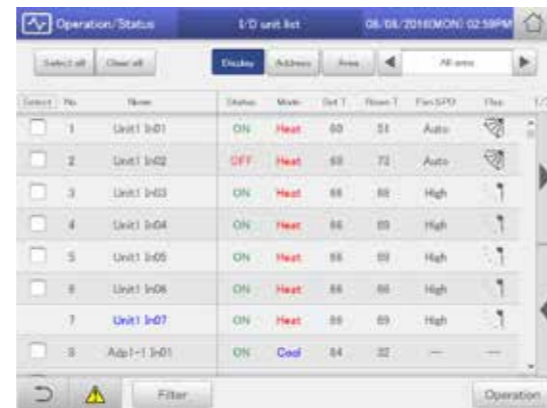

Display image on the remote PC is same design as the controller unit.

System configuration

The following is an example of a system configuration.

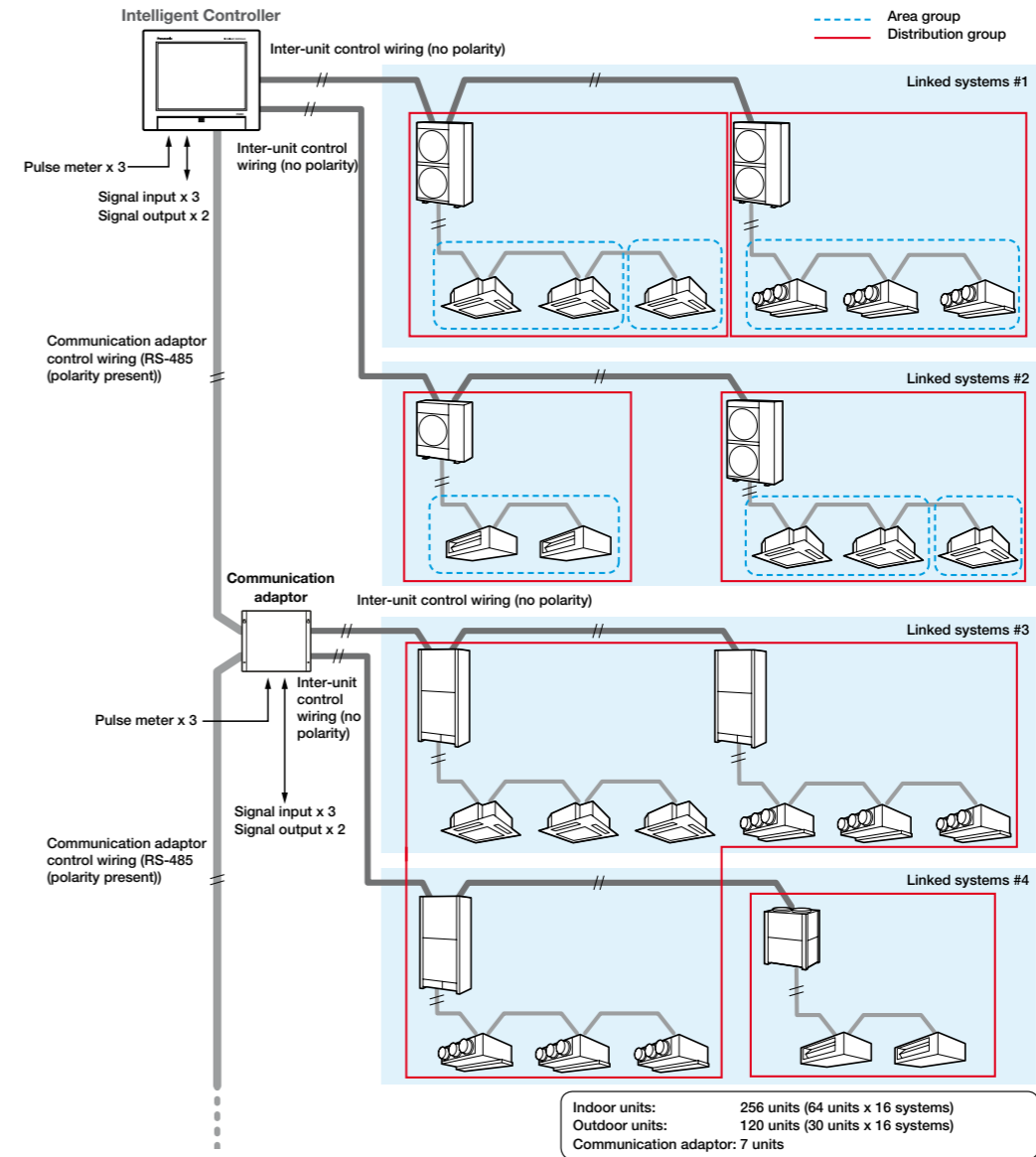

Communication adaptor (CZ-CFUNC2)



* Required when more than 129 indoor units are connected.



T10 Terminal for External Control (Digital Connection)

Connecting an FSV indoor unit to an external device is easy. The T10 Terminal featured in the electronic circuit board of all indoor units enables digital connection to external devices.



1. T10 Terminal Specification (T10:CN061 at indoor unit PCB)

- Control items: 1. Start/stop input (eg hotel key card, push button operation)
- 2. Remote controller prohibit input
- 3. Operation status output (eg fresh air fan)
- 4. Fault status output

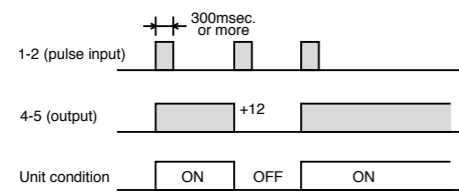

NOTE: The wire length from indoor unit to the Relay must be within 2.0m. Pulse signal changeable to static with JP cutting. (Refer to JP001)

Example of wiring

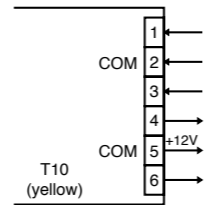

Condition

- 1-2 (Pulse input): Unit ON/OFF condition switching with a pulse signal. (1 pulse signal: shortage status more than 300msec.or more)
- 2-3 (Static input): Open/ Operation with Remote is permitted.(Normal condition) Close/ Remote controller is prohibited.
- 3-4-5 (Static output): 12V output during the unit ON. / No output at OFF.
- 4-5-6 (Static output): 12V output when some errors occur / No output at normal.

2. Usage Example

Forced OFF control

Condition

1-2 (Static input): Close/ Operation with Remote is permitted. (Normal condition) Open/ Unit is forcibly OFF and Remote controller operation is prohibited.

Example of wiring

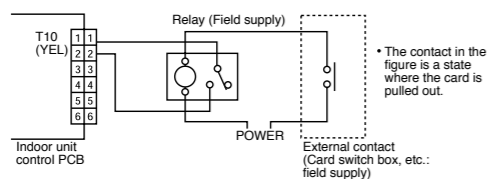

NOTE: The wire length from indoor unit to the Relay must be within 2.0m

Operation ON/OFF signal output

Condition

4-5 (Static output): 12V output during the unit ON / No output at OFF

Example of wiring

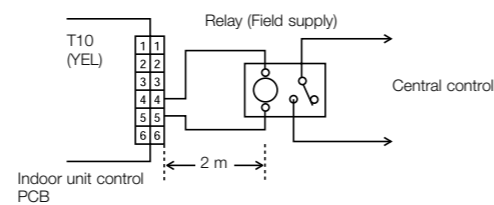

NOTE: The wire length from indoor unit to the Relay must be within 2.0m. Pulse signal changeable to static with JP cutting. (Refer to JP001)

Interfaces for External Control (Digital Connection)

Seri-Para I/O unit for each indoor unit (CZ-CAPBC2)



System example

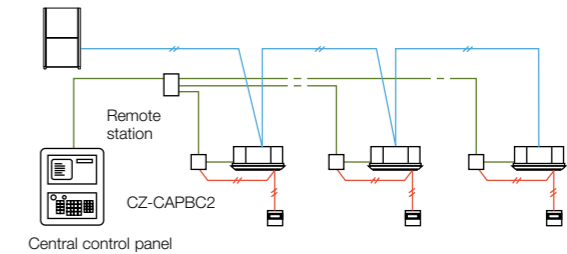

- Control and status monitoring is possible for individual indoor unit (1 group).
- In addition to operation and stop, there is a digital input function for air speed and operation mode.
- Temperature setting and measuring of the indoor suction temperature can be performed from central monitoring.
- The analog input for temperature setting is 0 to 10 V, or 0 to 140 Ohm.
- Power is supplied from the T10 terminal of the indoor units.
- Separate power supply also is possible (in case of suction temperature measuring).

Interface adaptor (CZ-CAPC3)



System example

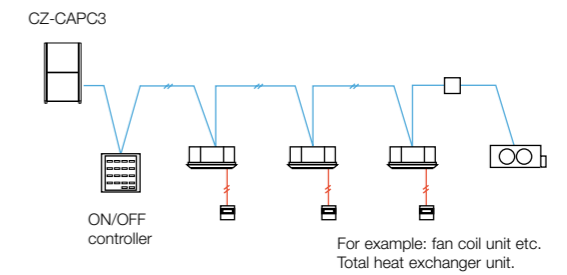

- Control and status monitoring is possible for individual indoor unit (or any external electrical device up to 250 V AC, 10 A) by contact signal.

Seri-Para I/O unit for outdoor unit (CZ-CAPDC2)



System example

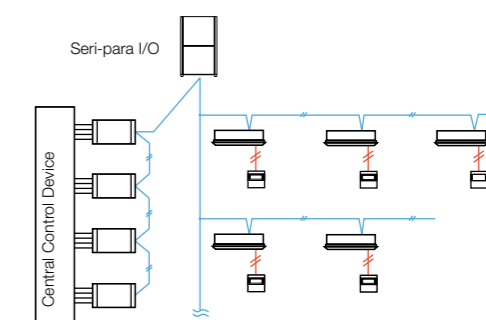

Dimensions H 80 x W 290 x D 260 mm
 Power supply Single phase 110-120/220-240 V (50/60 Hz), 18 W
 Input Batch operation/Batch stop (non-voltage contact/DC 24 V, pulse signal), Cooling/Heating (non-voltage contact/static signal), Demand 1/2 (non-voltage contact/static signal) (Local stop by switching)
 Output Operation output (non-voltage contact), Alarm output (non-voltage contact)
 Wiring length Indoor/Outdoor operation lines: Total length 1 km. Digital signal: 100 m or shorter

- This unit can control up to 4 outdoor units.
- From the centre control device, mode changing and batch operation/batch stop are possible.
- Required for demand control.

Serial Interface for 3rd Party External Controller

Example of 3rd party BMS connection with CZ-CFUNC2
(For the detail please consult to authorized dealer)

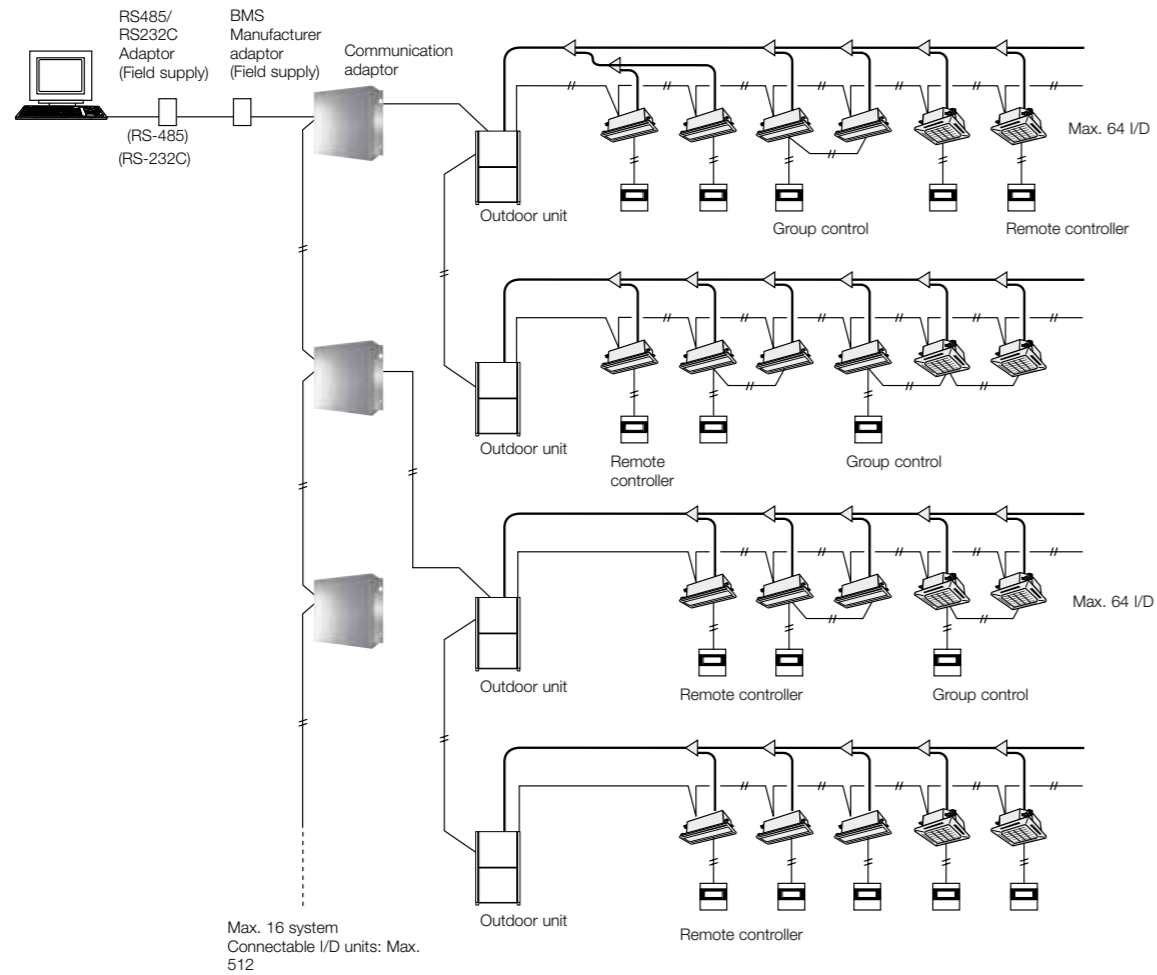

Functions via communication adaptor [CZ-CFUNC2]	
A/C unit settings	Unit ON/OFF
	Mode-change
	Room temperature setting
	Fan speed setting
	Flap setting
	Central control setting
	Filter-sign clear
	Alarm reset
A/C unit status	Unit ON/OFF status
	Operation mode
	Setting temperature
	Fan speed status
	Flap status
	Central control setting
	Filter-sign situation
	Correct/incorrect status
Alarm code	

Communication Adaptor (CZ-CFUNC2)



Up to 128 indoor units can be connected to one Communication Adaptor.

Serial Interface for LonWorks Network

LonWorks Interface (CZ-CLNC2)



- This interface is a communications converter for connecting LonWorks to the control network of FSU.
- From the host connected to LonWorks, basic settings and status monitoring is possible for up to 16 groups of indoor units.

System example

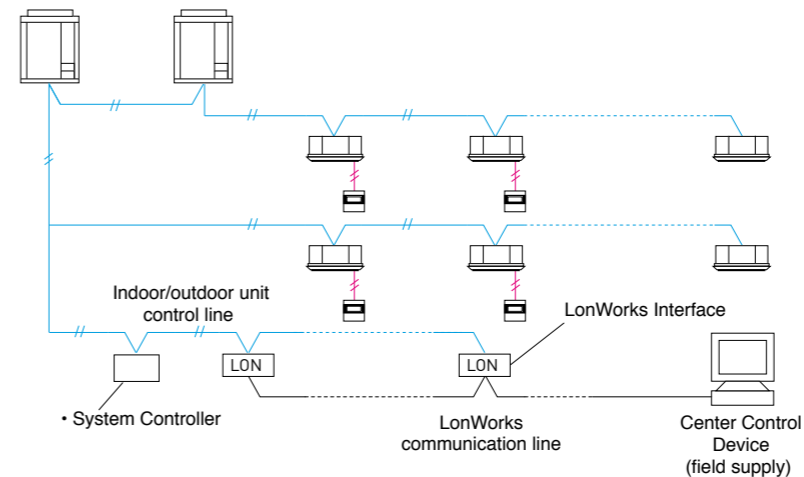

Functions

A/C unit settings from the LonWorks communicator	Settings for each group of indoor units	Start/stop
		Temp. setting
		Operation mode
		Option 1 settings
		Option 2 settings
A/C unit status notifications made to the LonWorks communicator	Settings for all units	Emergency stop
		Start/stop
		Temp setting
		Operation mode
		Option 1 settings
		Option 2 settings
		Alarm status
		Indoor units with active alarms
		Room temp.
		A/C unit status
Configuration properties		Transmission intervals settings
		Minimum time secured for transmission

FSV Controller External Dimensions

SIMPLIFIED WIRED REMOTE CONTROLLER
(CZ-RTC6WBL / CZ-RTC6BL)

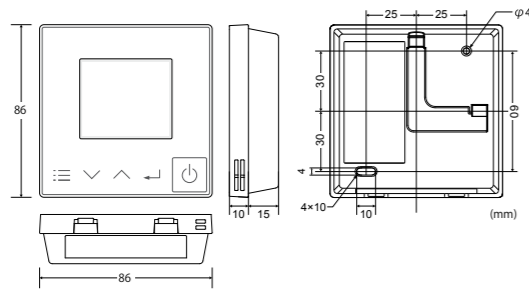

HIGH-SPEC WIRED REMOTE CONTROLLER
(CZ-RTC5)

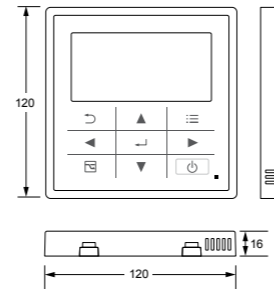

COMMUNICATION ADAPTOR
(CZ-CFUNC2)

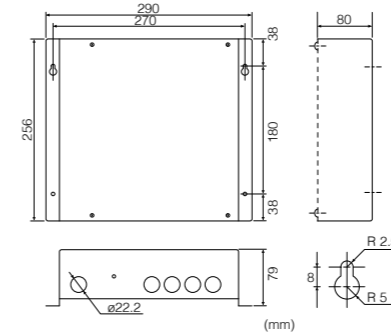

INTELLIGENT CONTROLLER
(CZ-256ESMC3)

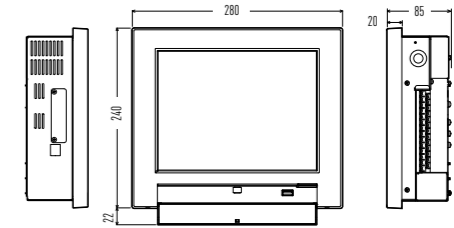

TIMER REMOTE CONTROLLER
(CZ-RTC4)

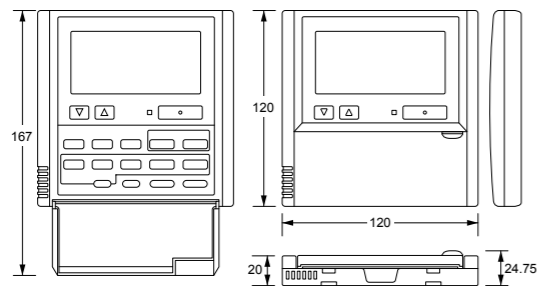

WIRELESS REMOTE CONTROLLER
(CZ-RWS3)

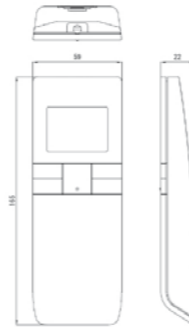

ON/OFF CONTROLLER
(CZ-ANC3)

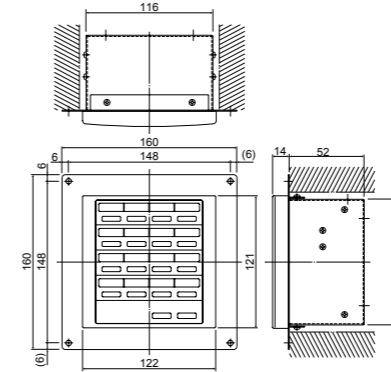

SERI-PARA I/O UNIT FOR EACH INDOOR UNIT
(CZ-CAPBC2)

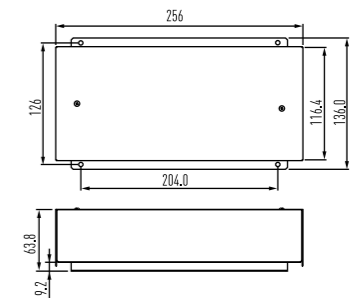

SEPARATE RECEIVER FOR WIRELESS REMOTE CONTROLLER
(CZ-RWSC3)

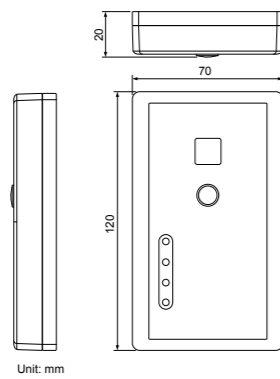

SYSTEM CONTROLLER
(CZ-64ESMC3)

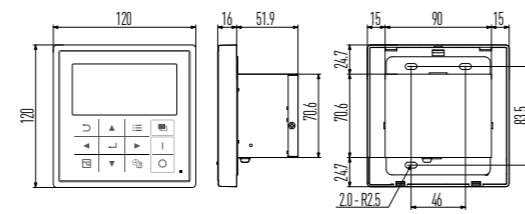

LONWORKS INTERFACE
(CZ-CLNC2)

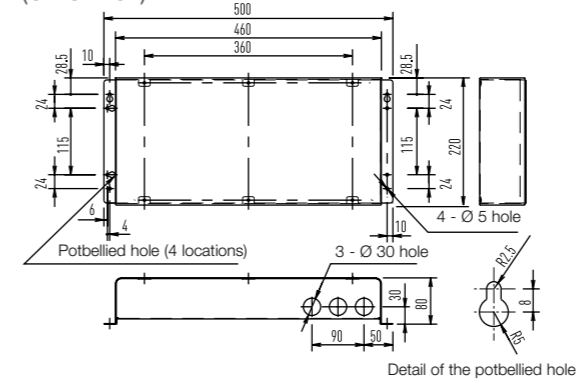

SERI-PARA I/O UNIT FOR OUTDOOR UNIT
(CZ-CAPDC2)

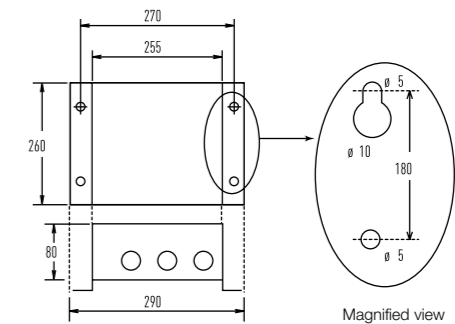

ECONAVI SENSOR
(CZ-CENSC1)

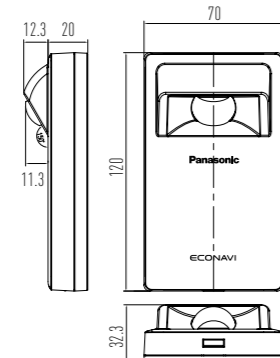

REMOTE SENSOR
(CZ-CSRC3)

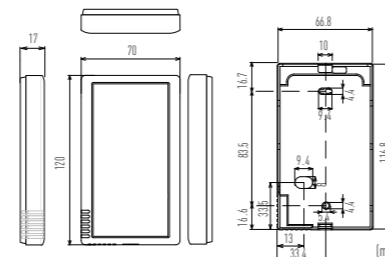

WLAN ADAPTOR
(CZ-CAPWFC1)

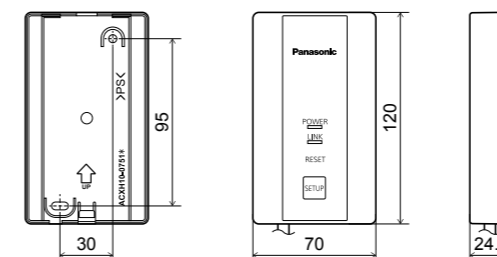

VRF Renewal

An important drive to further reduce the potential damage to our ozone



R22 is a HCFC and classified as an ozone depleting substance banned under the Montreal Protocol. Many existing R22 VRF Systems will need to be replaced over the coming years by more modern and efficient R410A VRF Systems.

Panasonic takes proactive action to switch to R410A refrigerant

Recognising consumers' anxiety and financial difficulties to adapt to the new R22 regulations, Panasonic developed a new cost-effective and simple solution to switch to R410A refrigerant.

What is Panasonic VRF Renewal?

Panasonic VRF Renewal enables reuse of good quality existing R22 pipe work to be installed with a new high efficiency R410A system.

What's so unique about Panasonic's solution?

By enabling reuse of existing R22 piping, consumers get to save substantially from reduced installation cost, and without any sacrifices to warranty or performance.

Ozone Depletion Potential		
R22	HCFCs	0.055
R410A	HFC	0
R407C	HFC	0

R22 - The reduction of Chlorine critical for a cleaner future

Before renewing piping, be sure to contact an authorised Panasonic dealer for advice.

VRF Renewal

Panasonic's Renewal system allows a completely new VRF system, indoor and outdoor units, to be installed using the existing systems pipe work. Panasonic's advanced technology enables the system to work with previously installed pipe work by managing the working pressure within the system down to R22 (3.3 bar) levels. This ensures the system works safely and efficiently without loss of capacity.

The new equipment has potential to increase COP/EER by using state of the art inverter compressor and heat exchanger technology.

Having contacted your Panasonic supplier regarding pipe work restrictions and gained approval to use the Panasonic Renewal System there are three main tests that have to be carried out to ensure that the system can be used effectively.

Firstly a thorough inspection of the pipe work must be carried out and any damage must be repaired.

Secondly an oil test has to be carried out to ensure that the system has not been subject to a compressor burnout during its lifetime.

Lastly a VRF Renewal Kit (CZ-SLK2) has to be installed within the pipe work to ensure that the system is cleaned of any oil residue.

VRF Renewal Kit (CZ-SLK2) and Sight Glass

The following shows an overview of the VRF Renewal Kit (CZ-SLK2) that is required when existing piping is reused. If the exact pipe length and pipe size of the existing piping are uncertain, attach a sight glass in accordance with the figure below. It will be used for checking the amount of additional refrigerant charge

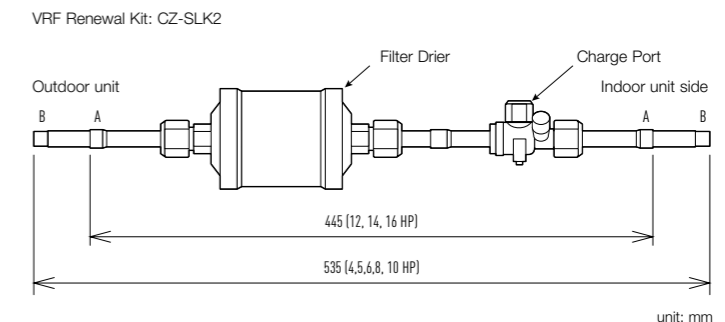

Attaching the Renewal Kit and sight glass

- To adjust the limited pressure level into 3.3 MPa, special setting is necessary on site.
- A filter drier shall be attached to the liquid piping of each outdoor unit.
- Do not need to remove Renewal Kit after a test run is performed as it can be retained for normal operation.
- When attaching Renewal Kit, be extra careful with regards to installation location and orientation of the filter drier and ball valve. Any mistakes will complicate maintenance work.
- Thermal insulation material (field supply: heat resistance of 80°C or higher and thickness of 10 mm or greater) shall be applied to the Renewal Kit.
- The filter drier of the Renewal Kit may need to be replaced depending on the condition of the existing unit. Use a Danfoss DMB 164 as the replacement filter drier (field supply).

Connecting pipe dimensions (Inch mm)

A Ø 1/2 (12.7) (33.5, 40.0, 45.0 kW)

B Ø 3/8 (9.52) (22.4, 28.0 kW)

Note: If the pipe size does not match that of the existing piping, use a reducer (field supply) to adjust the pipe diameter.

Sight glass (field supply)

If the exact pipe length and pipe size of the existing piping are uncertain, attach a sight glass to the liquid piping, and use it to check whether there is an appropriate amount of additional refrigerant charge.

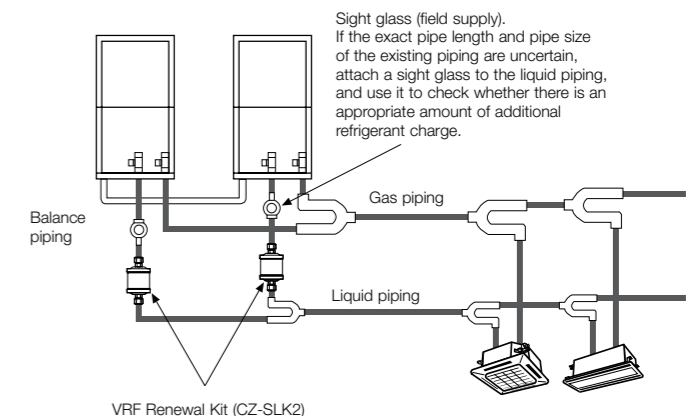

Procedure for VRF Renewal

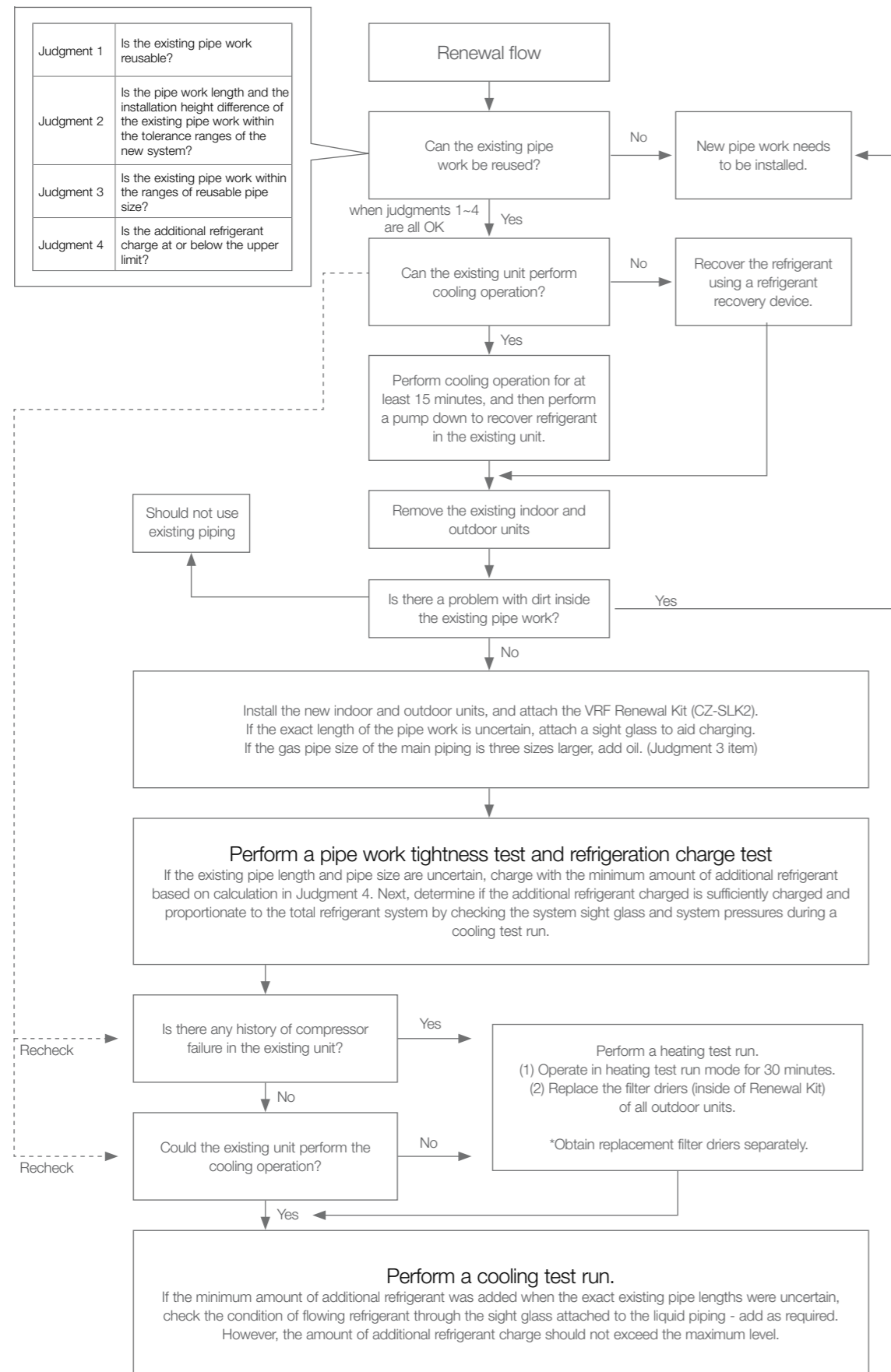

A Globally Trusted Air Conditioning Brand

With roots going back 60 years, the Panasonic Air Conditioning Business Division has grown to become a multinational company recognised around the world. Driven by a never-ending quest for product innovation, the group has evolved from manufacturing compressors to providing comprehensive air conditioning solutions. Panasonic has become a brand that people trust to deliver products with superior quality and reliability.

Panasonic's persistent innovation spurs the evolution of air conditioning solutions.

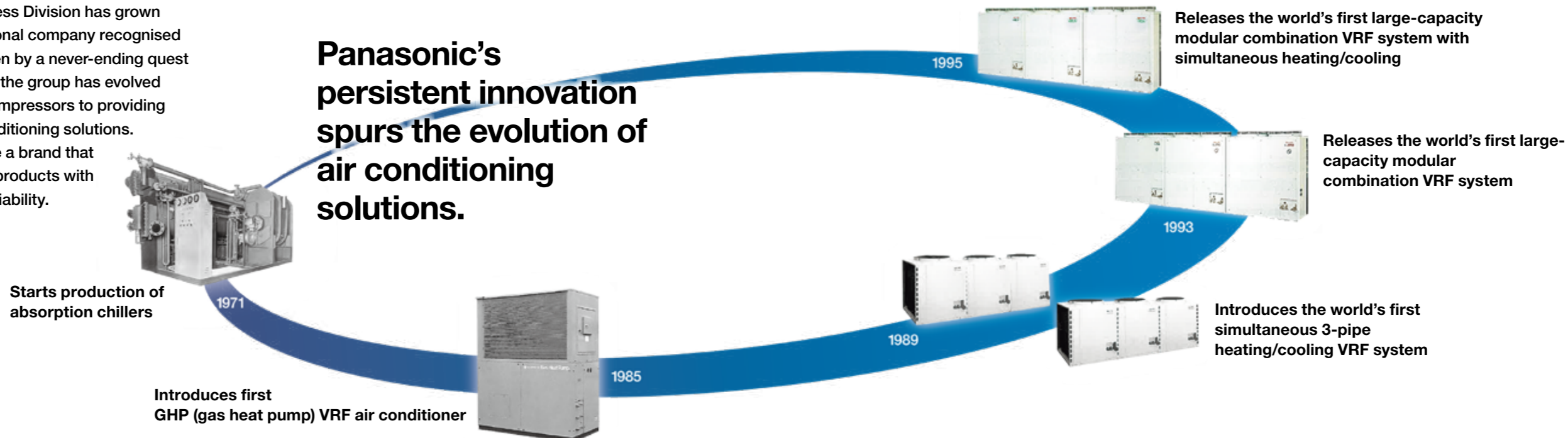

1957

- Start of the Home Cooler business

1958

- Panasonic (using the National brand) introduces its first Home Cooler, a window-type air conditioner model
- Electrical Appliance Business Group (Kadoma) starts manufacture of Home Coolers
- Sales of Home Coolers begin



1961

- Starts exports of Home Coolers to South Vietnam

1965

- Launches Room Coolers



1968

- Begins development of rotary compressors
- The high efficiency and quality of these compressors draw interest from domestic and overseas air conditioner manufacturers
- External sales begin

1969

- Begins production at the Kusatsu Factory in Shiga Prefecture, Japan

1972

- MAICO, the Division's first overseas manufacturing base, established in Malaysia
- Begins operating twin-based system in Japan and Malaysia



1983

- Launches inverter air conditioners
- Starts sale of Panasonic's first inverter air conditioners
- Inverters grow to become a core technology in the air conditioner industry
- Starts shipment of air conditioners to Panasonic America



1985

- Begins development of scroll compressors

1990

- Launches world's first air conditioner equipped with compact scroll compressor

1993

- Establishes Matsushita-Wanbao (Guangzhou) Air Conditioner (MWAC)
- Establishes Matsushita-Wanbao (Guangzhou) Compressor (MWCC)
- Establishes Matsushita Air Conditioner Engineering (Matsushita ACE)

2003

- Launches automatic filter-cleaning function for air conditioners (AC robot)



- Debuts quiet, lightweight, compact EcoCute systems with improved energy-saving technology
- EcoCute adopts highly efficient, accumulator-less CO₂ scroll compressor
- CO₂ heat-pump hot water heater (Eco Cute) uses non-toxic, non-combustible natural refrigerant (CO₂) in place of freon, to reduce environmental impact
- Begins production of new energy-saving mini-VRF series multi-split packaged air conditioners for residential use



2005

- Panasonic products become extremely successful in Japan's air conditioner market as innovations such as airstream robots and motion sensors help grow Panasonic's market share

2006

- Cumulative global production of Panasonic compressors reaches 200 million units

2008

- Starts air-to-water heat pump business in Europe
- Hot water heating considered an eco-friendly alternative to conventional fuel-type heating systems
- At the Energy Conservation Grand Prize awards, Panasonic air conditioners wins the Energy Conservation Center of Japan (ECCJ) Chairman's Prize, whilst EcoCute wins the Agency of Natural Resources and Energy Director General's Prize (prizes presented by ECCJ)
- nanoe™ technology installed on room air conditioners



2009

- Establishes sales company in Europe (PHAAE) dedicated to selling air conditioners
- Panasonic HA Air-Conditioning Europe (PHAAE) strengthens company's commercial air conditioning business

2010

- Begins collaboration with SANYO air conditioner business
- Through share exchange, SANYO and Panasonic Electric Works become wholly owned subsidiaries

2012

- Launches FSV series of large-capacity VRF air conditioners
- New Panasonic Group inaugurated

2013

- Expands VRF operation in Malaysia



2015

- Air-Conditioner Company established

2016

- Partnership with Schneider Electric begins
- At the Energy Conservation Grand Prize awards, WX series room air conditioner wins the Ministry of Economic, Trade and Industry Prize for energy conservation



2017

- Celebrates 60th anniversary in air conditioning business
- Division completes its first acquisitions: A.M.P. Air Conditioning Ltd of the UK, and UNION RHAC TECNOLOGIA of Brazil

2018

- Establishes commercial air conditioner sales company in China (PAPAECN)

2019

- Name changes to Heating and Cooling Solutions Business Division
- Panasonic and Systemair announce development of integrated HVAC&R and ventilation solutions
- Panasonic and Welcome Air Tech's SAIVER announce development of connected air handling and VRF solution for Southeast Asia

2021

- R32 mini-VRF launches in Europe
- Heating & Ventilation A/C Company is established

2022

- nanoe™ X Generator Mark 3 (100 x) is introduced

Reliability and Durability

At Panasonic, we believe that the best air conditioner is one that works quietly and effectively in the background whilst minimising its impact on the environment. People who use our products can look forward to long years of high-quality performance without the need for constant maintenance. As part of our rigorous design and development process, Panasonic air conditioners undergo a variety of stringent tests to ensure their effectiveness and long-term reliability. Tests for durability, waterproofing, shock resistance, and noise are conducted on component parts or on the finished products themselves. As a result of all of these painstaking efforts, Panasonic air conditioners meet even the most demanding industrial standards and regulations in every country where they are sold.



Applying advanced technologies that truly make life better, we live by an unparalleled commitment to product quality. Our approach to product development originates in the DNA of Japanese craftsmanship. Panasonic is building on the Japanese tradition of uncompromising quality control worldwide, developing and manufacturing fine products and delivering them to customers everywhere.



Testing laboratory Panasonic Gunma, Japan (PAPARS)

Durability

At Panasonic we know the importance of a long service life with minimal maintenance. That's why we subject our air conditioners to a wide range of stringent durability tests.



Long-Term Durability Test

To ensure durability and stable operation for many years, we conduct a long-term continuous operation test under conditions that are much more severe than actual operating conditions.



Compressor Reliability Test

After the continuous operation test, we remove the compressor from a selected outdoor unit, disassemble it, and examine the internal mechanisms and parts for potential failure. This helps ensure reliable long-term performance under harsh conditions.



Waterproofing Test

The outdoor unit, which is subject to rain and wind, complies with IPX4 waterproof specifications. Contact sections on printed circuit boards are resin-potted to prevent adverse effects caused by exposure to water (an unlikely occurrence).

A resin-potted circuit board

International Standard Quality

To uphold the company's reputation around the world, Panasonic strives continuously to offer the highest quality with the lowest possible environment impact.



The strength of the resin material used in a propeller fan is confirmed by a tension test

Reliable Parts That Meet or Exceed Industrial Standards

In every country where they are sold, Panasonic air conditioners comply with all required industrial standards and regulations. In addition, Panasonic conducts stringent testing to ensure the reliability of parts and materials.



RoHS / REACH Compliant Parts

All Panasonic parts and materials comply with Europe's strict RoHS/REACH environmental regulations. During the development and production of parts, stringent inspections are conducted on over 100 materials to ensure that no hazardous substances are included.



Sophisticated Production Process

Panasonic's air conditioner production lines employ state-of-the-art factory automation technologies to ensure products are manufactured efficiently and with uniformly high levels of quality and reliability.

Global Networking of Heating and Cooling Solutions

In any indoor environment, eco-friendly air conditioning plays a vital role in maintaining our health, comfort, and productivity. Whether it's an office, a hotel, or a shopping mall, every building matters. That's why Panasonic has developed energy-efficient large-scale heating and cooling solutions to suit a variety of business applications. As one of the pillars of Panasonic's BtoB operations, our heating and cooling sector provides comprehensive solutions to businesses around the world. Harnessing our advanced technology and extensive on-site expertise, we serve clients in a diverse range of environments throughout the world.

Panasonic air conditioning solutions are designed from the ground up to meet the specific needs of each location, whilst placing a premium on efficiency and reliability. At every stage, we seek to make optimal use of resources and energy to create solutions that benefit the environment.

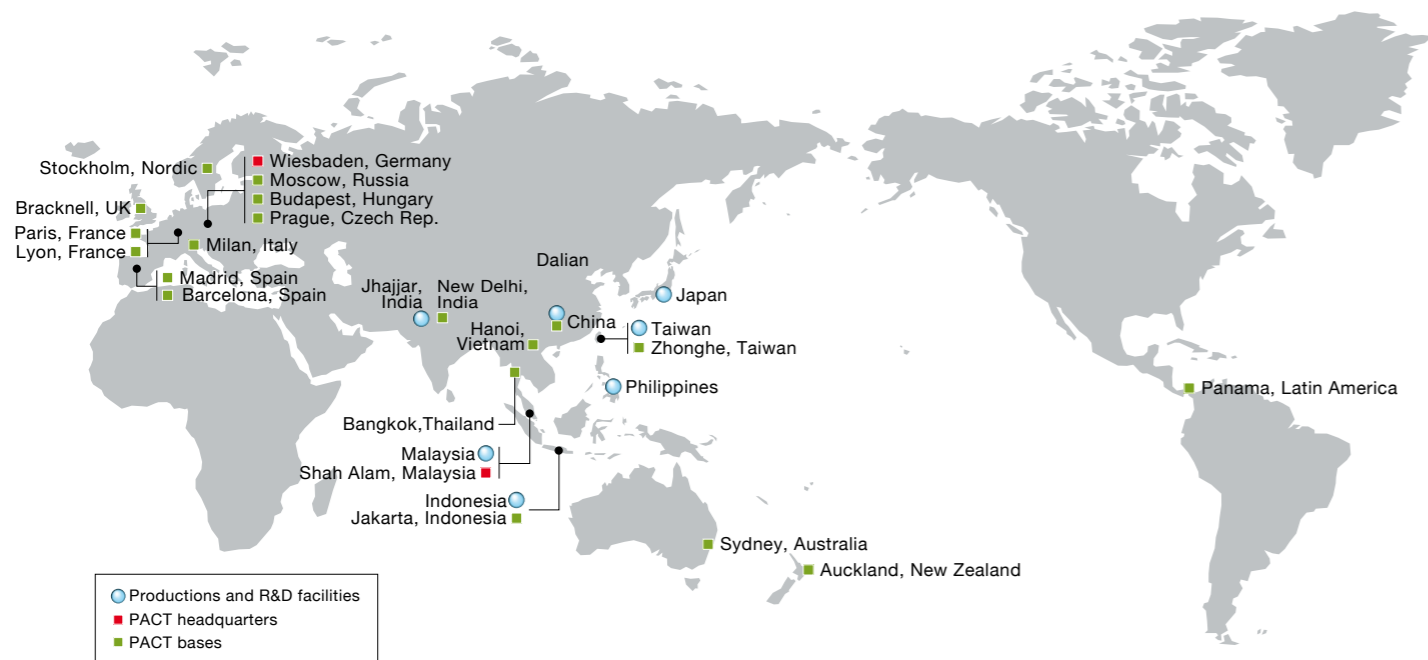

PACT Training Facilities

The 42 Panasonic Air Conditioning Training Centers (PACTs) around the world provide a wide range of support for Panasonic's business-use air conditioning systems. PACT represents Panasonic's unwavering commitment to our sales partners, distributors, and service teams in Europe, Asia, Oceania, and the Americas.



Quality Assurance from Japan to the World

With a diverse network of production and R&D facilities, Panasonic delivers innovative products incorporating cutting-edge technologies that set the standard for air conditioners worldwide. As our business expands globally, we strive to transcend borders with our superior-quality products.

Japan



Heating & Ventilation A/C Company Headquarters

Established October 2021



Heating & Ventilation A/C Company Heating & Cooling Solutions Business Division Residential Air-Conditioning Business Unit

Established April 1972
• Corporate Engineering Division



Heating & Ventilation A/C Company Heating & Cooling Solutions Business Division Commercial Air-Conditioning Business Unit

Panasonic Appliances Air-Conditioning and Refrigeration Systems Co., Ltd.

Established July 1959
• Air conditioners
• Cold-chain/refrigeration products

Malaysia



PAMAMY Panasonic Appliances Air Conditioning Malaysia Sdn. Bhd.

Established April 1972
• Air conditioners
• Air-to-water heat pumps



PAPANADMY Panasonic Appliances Air Conditioning R&D Malaysia Sdn. Bhd.

Established June 1991
• R&D for air conditioners
• Air-to-water heat pumps



PAMAMY Compressor

Established January 1987
• Rotary compressors for air conditioners



PAMAMY Compressor R&D

Established September 1997
• R&D for rotary compressors

China



PAPAGZ Panasonic Appliances Air Conditioning (Guangzhou) Co., Ltd.

Established June 1993
Air conditioners



PRDCS Panasonic R&D Center Suzhou Co., Ltd.

Established April 2002
• Air conditioners
• R&D for home appliance products

Taiwan



PTW Panasonic Taiwan Co., Ltd.

Established October 1962
• Air conditioners
• Automotive air conditioners
• Home appliance products



PMI Panasonic Manufacturing Indonesia

Established September 1970
• Air conditioners
• Home appliance products



PMPC Panasonic Manufacturing Philippines Corporation

Established September 1967
• Air conditioners
• Home appliance products



PI Panasonic India Pvt. Ltd.

Established December 2012
• Room Air conditioners

PACT Headquarters and Bases

EUROPE



Germany Wiesbaden

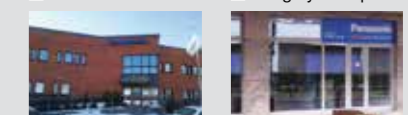

Nordic Stockholm Hungary Budapest

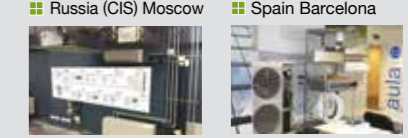

Russia (CIS) Moscow Spain Barcelona

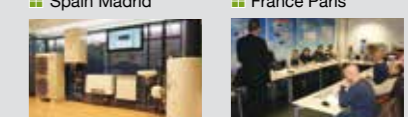

Spain Madrid France Paris

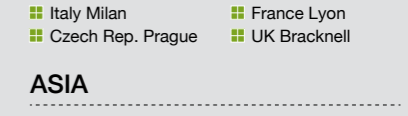

Italy Milan Czech Rep. Prague France Lyon



UK Bracknell

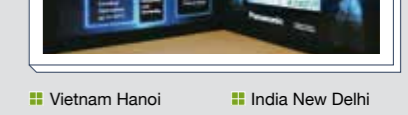

Malaysia Shah Alam



Vietnam Hanoi India New Delhi



Thailand Bangkok Taiwan Zhonghe Indonesia Jakarta



Australia Sydney New Zealand Auckland

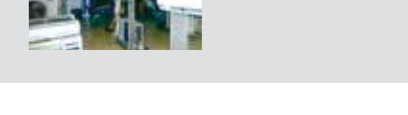

Latin America Panama

Panasonic VRF Global Project References

Panasonic air conditioning systems provides comprehensive solutions to businesses around the world. Harnessing our advanced technology and extensive on-site expertise, we serve clients in a diverse range of environments throughout the world.

HOTEL

Australia Travelodge Hobart



Air Conditioning System:
VRF 3-way FSV MF2 series 8 systems
Indoor Units: 116 units
Cooling Capacity:
302 kW / 86 USRT

Indonesia Patra Jasa Hotel



Air Conditioning System:
VRF 2-way ME1 series
14 systems
Indoor Units: 132 units
Cooling Capacity:
677 kW / 193 USRT

Spain Hotel Claris 5 GL



Air Conditioning System:
VRF 2-way ME1&LE1 series
11 systems
VRF 3-way MF1 series 14 systems
Indoor Units: 233 units
Cooling Capacity: 769 kW / 218 USRT

Spain Monument Hotel



Air Conditioning System:
VRF 2-way ME1 series 4 systems,
VRF 3-way 12 systems
Indoor Units: 171 units
Cooling Capacity:
592 kW / 168.33 USRT

Spain LAVIDA Hotel PGA Catalunya Resort



Air Conditioning System:
VRF 2-way FSV ME2 series 2 systems
Indoor Units: 54 units
Cooling Capacity: 236 kW / 67 USRT

Russia River Park Hotel



Air Conditioning System:
VRF 2-way ME1 series 47 systems
Indoor Units: 96 units
Cooling Capacity: 788 kW / 224 USRT

Germany The LEGOLAND Castle Hotel



Air Conditioning System:
VRF 3-way MF2 series 12 systems
Indoor Units: 144 units
Cooling Capacity:
592 kW / 168.33 USRT

Ireland K Club, Co. Kildare



Air Conditioning System:
VRF 3-way FSV MF2 series 10 systems
Indoor Units: 70 units
Cooling Capacity: 200 kW / 56.87 USRT

OFFICE

New Zealand 151 Cambridge Terrace



Air Conditioning System:
VRF 3-PIPE FSV MF2 series:
20 systems
Indoor Units: 75 units
Cooling Capacity:
850 kW / 242 USRT

New Zealand IAG Christchurch



Air Conditioning System:
VRF 3-PIPE FSV MF2 series:
25 systems
Indoor Units: 132 units
Cooling Capacity:
976 kW / 278 USRT

Malaysia Gaprana project



Air Conditioning System:
VRF 2-PIPE FSV ME1 series
109 systems
Indoor Units: 537 units
Cooling Capacity:
5,370 kW / 1,526 USRT

Malaysia Plaza 33 Office Block A



Air Conditioning System:
VRF 2-PIPE FSV ME1 series
99 systems
Indoor Units: 153 units
Cooling Capacity:
3,667 kW / 1,042 USRT

Thailand Areeya



Air Conditioning System:
VRF 2-PIPE FSV ME1 series 19 systems
Single split system 67 systems
Indoor Units: 85 units
Cooling Capacity:
1,519 kW / 432 USRT

HongKong King Yip Road



Air Conditioning System:
VRF FSM LA1 series
136 systems
Indoor Units: 294 units
Cooling Capacity:
2,108 kW / 599 USRT

Spain PTA Malaga



Air Conditioning System:
VRF 2-PIPE ME1 series
20 systems
Indoor Units: 74 units
Cooling Capacity:
908 kW / 258 USRT

Russia Russian Government Building



Air Conditioning System:
VRF 2-PIPE ME1 series 42 systems
Indoor Units: 277 units
Cooling Capacity:
2,045 kW / 581 USRT

RETAIL

Italy Le Centurie CENTRO COMMERCIALE



Air Conditioning System:
VRF 3-way MF1 series
18 systems
Indoor Units: 57 units
Cooling Capacity:
656 kW / 186 USRT

India Sai Aarav Motors, Mehsana



Air Conditioning System:
VRF 2-way FSV ME1 series 3 systems
Indoor Units: 19 units
Cooling Capacity: 156 kW / 44 USRT

Russia Sun City Mall



Air Conditioning System:
VRF 2-way ME1 series
47 systems
VRF 3-way 12 systems
Indoor Units: 283 units
Cooling Capacity:
1,605 kW / 456 USRT

SCHOOL

United States Shippensburg University



Air Conditioning System:
VRF 3-Way MF1 series
55 systems
Indoor Units: 530 units
Cooling Capacity:
1,498 kW / 426 USRT

SCHOOL

Malaysia Xiamen University



Air Conditioning System:
VRF FSV Systems 110 systems
Indoor Units: 1,349 units
Cloud adapter: CZ-CFUSCC1 17pcs

Russia Technopark of Nobosibirsk Academgorodok



Air Conditioning System:
VRF 2-way ME1 series 38 systems,
VRF 3-way 12 systems
Indoor Units: 234 units
Cooling Capacity:
1,487 kW / 422 USRT

HOSPITAL

Indonesia Bekasi Hospital



Air Conditioning System:
VRF 2-way FSV ME1 series
42 systems
Indoor Units: 283 units
Cooling Capacity:
1,834 kW / 524 USRT

Indonesia Persada Hospital



Air Conditioning System:
VRF 2-way FSV ME1 series
21 systems
Indoor Units: 116 units
Cooling Capacity:
989 kW / 281 USRT

HOSPITAL

France Clinique Dentaire Ablis (Dental Clinic)



Air Conditioning System:
mini VRF 2-way mini FSV LE1 series 3 systems
Cooling Capacity:
36.3 kW / 10.3 USRT

RESIDENTIAL

China Star River Group Luxury Condominium



Air Conditioning System:
VRF Master series 966 systems
Indoor Units: 3,948 systems
Cooling Capacity:
16,737 kW / 4,755 USRT

Singapore Punggol Eco-Town



Air Conditioning System:
Inverter multi-split
room air conditioner
Indoor Units:
Wall mounted S series (with ECOAVI)
Control System: Panasonic HEMS

Hong Kong Gloucester Road Project



Air Conditioning System:
VRF FSM LA1 series 67 systems
Twenty series 105 systems
Indoor Units: 255 units
Cooling Capacity: 1,391 kW / 395 USRT

Hong Kong The Green Project



Air Conditioning System:
VRF FSM LA1 series 239 systems
Twenty series 538 systems
Indoor Units: 999 units
Cooling Capacity:
6,425 kW / 1,825 USRT

India Royal Orchids Eco-Green Homz



Air Conditioning System:
VRF 2-way FSV ME1 series
22 systems
Indoor Units: 139 units
Cooling Capacity:
802 kW / 228 USRT

India Heera Windfaire



Air Conditioning System:
VRF 2-way FSV ME1 series 96 systems,
VRF 3-way 12 systems
Indoor Units: 479 units
Cooling Capacity: 2,184kW / 620 USRT

Panama Mosaic Building PANAMA PACIFICO



Air Conditioning System:
VRF 2-way FSV LE1 series 156 systems
Indoor Units: 357 units
Cooling Capacity: 2,338 kW / 664 USRT