

Panasonic®

**Building Passion,
Building Solutions.**
Panasonic Air Conditioning Systems

We face a time in which "quality air" differentiates business. It's a time for Panasonic to fully display its strengths. Our ability to assemble and build superior systems isn't just due to the rich resources we have as a comprehensive electronics manufacturer, but also to Panasonic's 100 years of tradition, where each person thinks and acts on their own initiative while working in a team to reach further heights. We do not compromise. Each of our independent selves is a one stop solution. We face our customers' challenges together with our customers and do all that we can to build effective systems. As a true partner for our customers, we strive to always be at the forefront of business.

- Please read the Installation Instructions carefully before installing the unit, and the Operating Instructions before using it.
- Specifications are subject to change without prior notice.
- The contents of this catalogue are accurate as of July 2023.
- Due to printing considerations, actual colours may vary slightly from those shown.
- All graphics are provided solely for the purpose of illustrating a point.



Do not add or replace refrigerant other than the specified type. Manufacturer is not responsible for damage or deterioration in safety due to usage of other refrigerant.

Authorised Dealer

OCAU_R32 PAC_CAT_2023_V1

Panasonic Australia Pty. Limited.

Address: 1 Innovation Road, Macquarie Park, NSW 2113
ACN 001 592 187 ABN 83 001 592 187

aircon.panasonic.com.au

R32 RESIDENTIAL & LIGHT COMMERCIAL AIR CONDITIONING



Scan for more Panasonic Air Conditioning information.
Connect with your smartphone using this QR

HVAC Site



Product information

PRO Club



Technical documents



QUALITY AIR FOR LIFE

The new Panasonic NX series

The next generation is now

The new CONEX remote controller (CZ-RTC6WBLW*1/CZ-RTC6BLW/CZ-RTC6WZ*1/CZ-RTC6Z) multiplies the benefits of a standard nanoe™ X installation, letting you create clean, healthy air in your living spaces 24 hours a day, anytime, anywhere. Choose your quality of air - a new era in air conditioning solutions is here.

CONTENTS

Product Line-up	4 - 5
Better Air Quality	6 - 9
Panasonic IoT Solution	10 - 11
CONEX & CONEX Zone Controller Comparison	12 - 13
CONEX	14 - 17
CONEX Zone Controller	18 - 19
Outdoor Unit	20 - 21

Indoor Unit	
High Static Pressure Ducted	22 - 25
High Static Pressure Splittable Ducted	26 - 27
High Static Pressure Adaptive Ducted	28 - 31
Ultra Slim Ducted	32 - 33
4-WAY Cassette	34 - 37
Low Profile Mini Cassette	38 - 39
Under Ceiling	40 - 43
Wall Mounted	44 - 45
Floor Console	46 - 47
Smart Control Management Solutions	48 - 49
Panasonic Comfort Cloud	50 - 51
Home Automation	52 - 53
PAC Smart Connectivity+	54 - 59
Panasonic AC Smart Cloud	60 - 61
Controllers	62 - 67



nanoe™ X

24-hour^{*2}
nanoe™ X Air purification

24-hour nanoe™ X Air Purification

Unlike the general filters found in an air purifier, nanoe™ X achieves a powerful inhibiting effect on not only airborne, but also adhered bacteria and viruses.

P. 6-9

P. 14-17

Make comfort more accessible with CONEX

CONEX goes beyond simple remote control to combine sophistication with simplicity, offering IoT integration that connects directly to a variety of apps for next-generation solutions.

P. 22-25 / P. 28-31

Maximum versatility adaptive ducted unit

Designed to deliver flexibility, performance, and comfort, Panasonic introduces an industry-leading horizontal/vertical design featuring powerful 150Pa static pressure in a compact unit.

Note: PF3 range only.

*1 Scheduled release date of 4th Quarter in CY23. Black models (CZ-RTC6BL/CZ-RTC6BLW/CZ-RTC6Z) are also available.

*2 The nanoe™ X mode can be run independently from cooling or heating mode, and needs to be on for the 24 hour air purification to function.

Product Line-up

		Cooling Capacity	2.5 kW	3.6 kW	5.0 kW	6.0 kW	7.1 kW	10.0 kW	12.5 kW	14.0 kW	16.0 kW	18.0 kW	20.0 kW	22.4 kW	
For Medium Sized Project	Indoor Unit	Ducted	NX Series High Static Ducted High Static Pressure Model Page 22-25 for 6.0kW to 16.0kW 				S-60PE3R	S-71PE3R	S-100PE3R	S-125PE3R	S-140PE3R	S-160PE3R			
		Ducted		NX Series Splittable Ducted High Static Pressure Model Page 26-27 for 18kW - 22.4kW 									S-180PE4R	S-200PE4R	S-224PE4R
		Ducted			NX Series Adaptive Ducted High Static Pressure Model Page 28-31 		S-3650PF3E	S-3650PF3E	S-6071PF3E	S-6071PF3E	S-1014PF3E	S-1014PF3E	S-1014PF3E		
		Cassette	NX Series 4-WAY Cassette * Panel is provided as an option (CZ-KPU3H/CZ-KPU3A) Page 34-37 					S-6071PU3E	S-6071PU3E	S-1014PU3E	S-1014PU3E	S-1014PU3E			
		Cassette		NX Series Low Profile Mini Cassette Page 38-39 	S-25PY3E	S-36PY3E	S-50PY3E	S-60PY3E							
		Under Ceiling	NX Series Page 40-43 					S-6071PT3E	S-6071PT3E	S-1014PT3E	S-1014PT3E	S-1014PT3E			
	Wall Mounted	NX Series Page 44-45 							S-100PK3R						
	Outdoor Unit		NX Series	R32 Deluxe Model Page 20-21 					U-71PZH3R5	U-100PZH3R5 U-100PZH3R8**	U-125PZH3R5 U-125PZH3R8**	U-140PZH3R5 U-140PZH3R8**	U-160PZH3R5 U-160PZH3R8**	U-180PZH3R5 U-180PZH3R8**	U-200PZH3R8**
		NX Series	R32 Compact Model Page 20-21 		U-25PZ3R5	U-36PZ3R5	U-50PZ3R5	U-60PZ3R5	U-71PZ3R5	U-100PZ3R5 U-100PZ3R8**	U-125PZ3R5 U-125PZ3R8**	U-140PZ3R5 U-140PZ3R8**			
	For Small Sized Project	Indoor Unit		Ducted	Ultra Slim Ducted Page 32-33 	CS-Z25UD3RAW	CS-Z35UD3RAW	CS-Z50UD3RAW	CS-Z60UD3RAW						
Floor Console			NX Series Page 46-47 	CS-Z25UFRAW		CS-Z35UFRAW	CS-Z50UFRAW								
Outdoor Unit		R32 Model 		CU-Z25UBRA	CU-Z35UBRA	CU-Z50UBRA	CU-Z60UBRA								

24-hour nanoe™ X Air Purification*1

nanoe™ X



Technical information

nanoe™ X works to inhibit longer-living, adhered bacteria and viruses. The CONEX remote control (CZ-RTC6WBLW*2/CZ-RTC6BLW/CZ-RTC6WZ*2/CZ-RTC6Z) gives you access to your air conditioner anywhere, anytime, so you can turn nanoe™ X on even while you're out and enjoy 24-hour quality air in your home.

Airborne Viruses
Last up to 3 hours

Glass surface

Virus lifespan up to 4 days

Adhered Viruses

Last up to 2-7 days

Wood

Virus lifespan up to 2 days

Fabrics

Virus lifespan up to 2 days

*1 The nanoe™ X mode can be run independently from cooling or heating mode, and needs to be on for the 24 hour air purification to function.
*2 Scheduled release date of 4th Quarter in CY23.

nanoe™ X Device Evolution

Dramatically increased release of hydroxyl radicals and making the high concentration of nanoe™ X in the space. The latest device, nanoe™ X Generator Mark 3, can be used in large spaces of more than 100 m² with greater effectiveness.

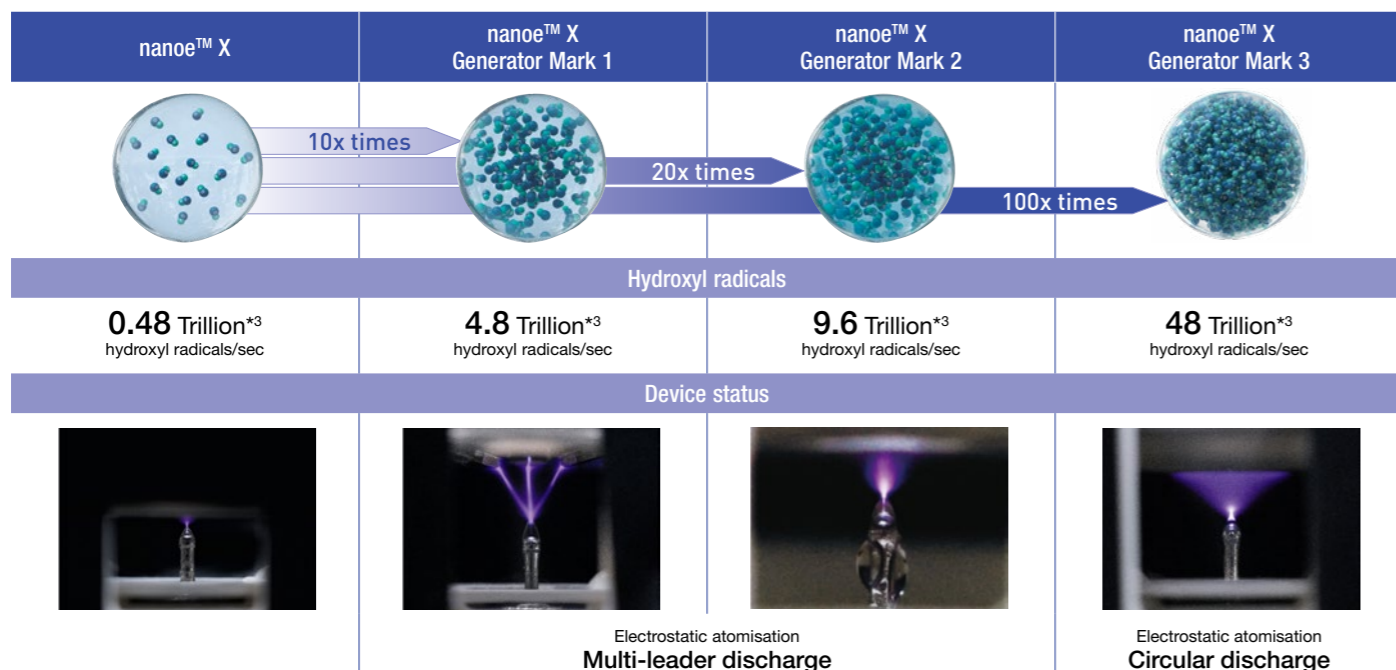

*3 Measured using the ESR method (amount of hydroxyl radicals immediately after release from the generator. (Source: Panasonic internal research))



nanoe™ X works even in larger spaces*4

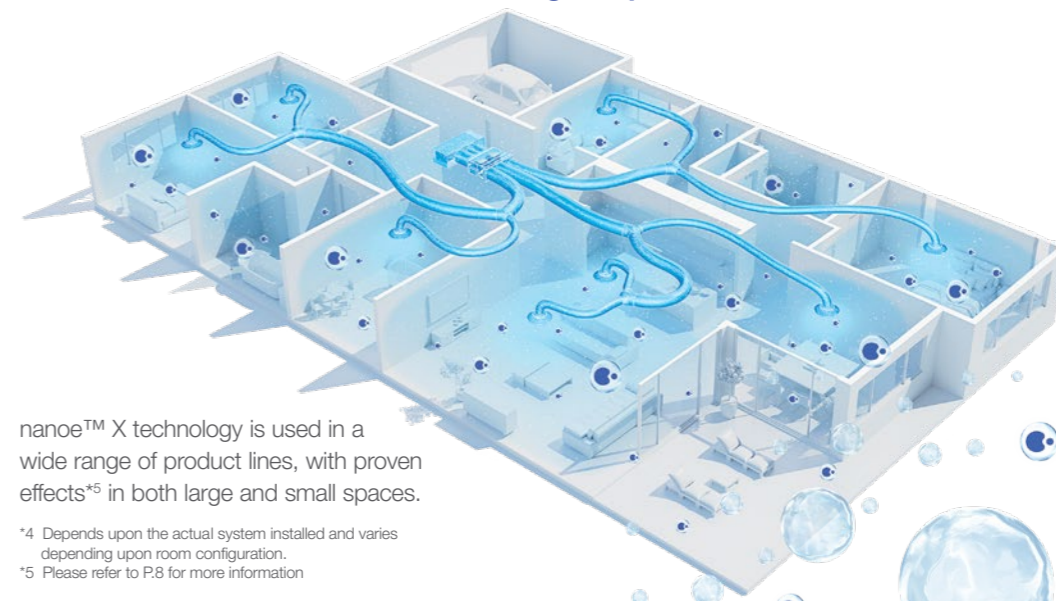

nanoe™ X technology is used in a wide range of product lines, with proven effects*5 in both large and small spaces.

*4 Depends upon the actual system installed and varies depending upon room configuration.
*5 Please refer to P.8 for more information

Standard ducted air conditioning system without nanoe™ X

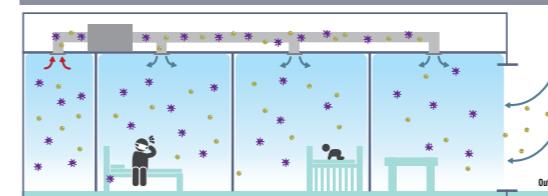

Viruses or bacteria carried by a room's occupants, as well as external pollutants from open windows, may actually be circulated around a home by conventional air conditioning.

Panasonic ducted air conditioning system with nanoe™ X

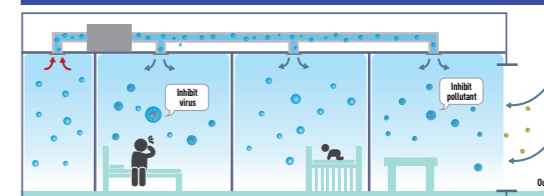

With a nanoe™ X-equipped ducted unit, it's not only viruses and bacteria that are circulated, the ducted unit itself produces a massive 9.6 trillion hydroxyl radicals per second which are delivered to rooms throughout the house, inhibiting viruses and bacteria.

24hr nanoe™ X comfort, wherever you are, anywhere, anytime

Get 24 hr Quality Air for you and your loved ones by turning nanoe™ X on using Panasonic Comfort Cloud*6 even when you're out, and enjoying clean air when you're at home. nanoe™ X functions in both cooling and heating modes and is maintenance-free, helping you keep your costs down with cleaner air.

Clean air independently when you are away
(Fan Mode + nanoe™ X ON)

Comfort and Clean air when you are at home
(Cooling or Heating Mode + nanoe™ X ON)

Only at 70W/Hour*7
Low energy consumption with fan mode 70W per hour for a single unit.

Maintenance-Free
No maintenance required for nanoe™ X generator device.

24-hour nanoe™ X Air Purification

*6 Wireless LAN Remote Control for Internet Connection required optional network adaptor. Indoor temperature display and some special function are not available through the App for some models.
*7 Energy consumption may vary depending on models and the external static pressure.



Verification tests for nanoe™ X effects in large spaces



Hazardous substances

The nanoe™ X inhibited hexadecane, a chemical contained in PM2.5 (267m²)

3rd party

A third-party certification organization SIRIM Berhad (SIRIM)^{*1}, conducted the performance experiment using a 4-Way Cassette equipped with a nanoe™ X device to inhibit hexadecane^{*2}, a chemical contained in PM2.5.

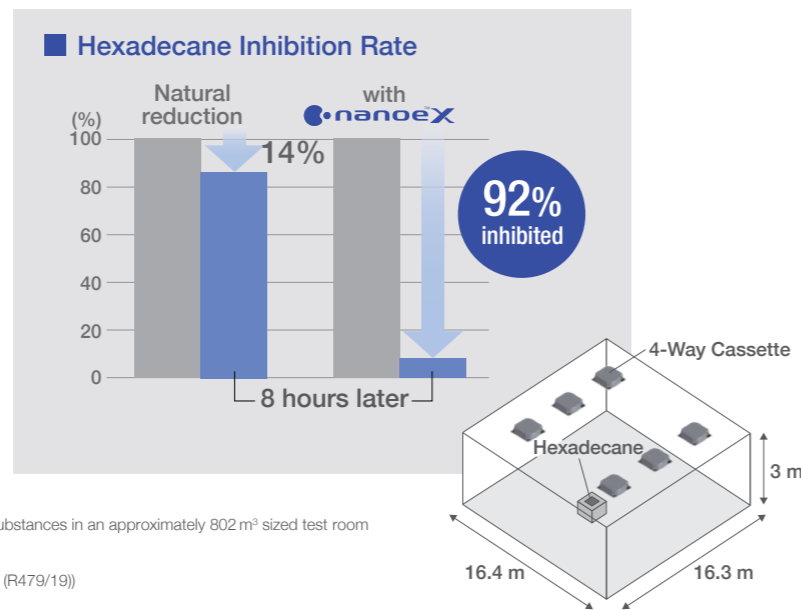

^{*1} SIRIM is a premier industrial research and technology organisation in Malaysia, a wholly-owned company of the Malaysian Government under the Ministry of International Trade and Industry (MITI).
^{*2} Hexadecane is a hazardous substance contained in gasoline and diesel exhaust gas.

Testing method: Measured the amount of attached organic substances in an approximately 802 m³ sized test room
 Inhibition method: nanoe™ X Generator Mark 1 released
 Test substance: Hexadecane
 Test result: Broken down 92% in 8 hours (ETRC257/16/1402 (R479/19))



odours

The nanoe™ X reduced the odours adhering to fibres such as curtains and carpets (139m²)

3rd party

Cigarette smoke odour

Results

Compared to natural reduction, the nanoe™ X blast reduced the odour intensity by more than approximately 0.7 after two hours.

Testing organization

KAKEN TEST CENTER General Incorporated Foundation in Japan, international testing institute.

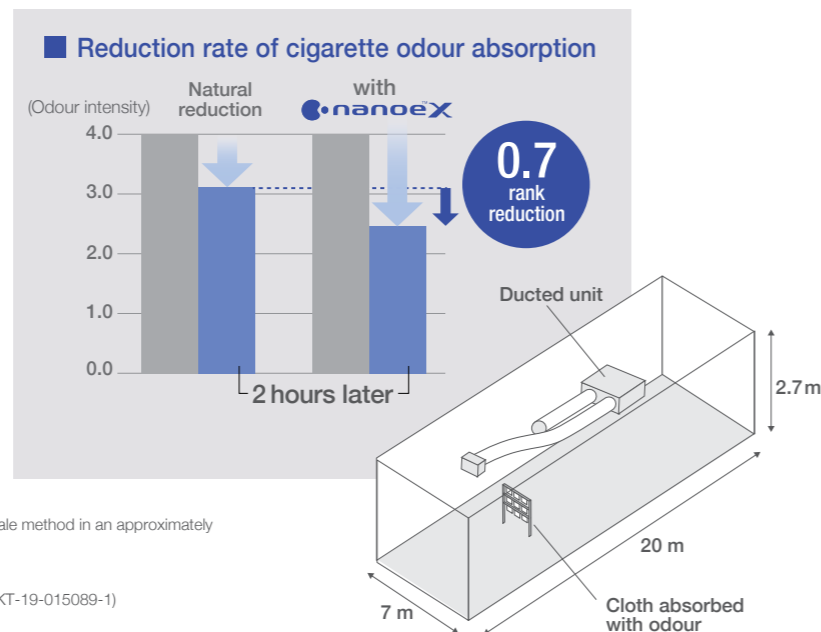

Testing method: Verified using the six-level odour intensity scale method in an approximately 378 m³ sized test room
 Inhibition method: nanoe™ X Generator Mark 2 released
 Test substance: Surface-attached cigarette smoke odour
 Test result: Odour intensity reduced by 0.7 levels in 2 hours (KT-19-015089-1)

The effects of nanoe™ X are recognised by experts in each field



Professor Masafumi Mukamoto
 Osaka Prefecture University
 Veterinary Infectious Disease Studies

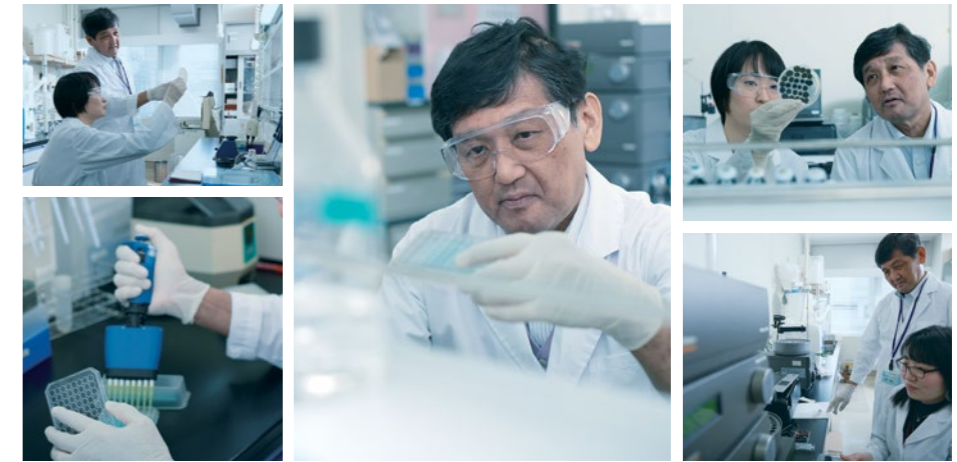

Various types of moulds enter houses along with people and air. Even if preventive action is taken in our everyday lives, it is often very difficult to inhibit the growth of mould, especially in humid environments. With nanoe™ X, we have experimental results^{*3*} that show we can inhibit the growth of the types of mould and bacteria commonly found in various places in the house.

Hope for the creation of more comfortable spaces for those who have problems with asthma or atopic dermatitis

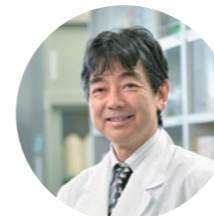

Professor Masahiro Sakaguchi
 Azabu University
 School of Veterinary Medicine
 Laboratory of Veterinary Microbiology I

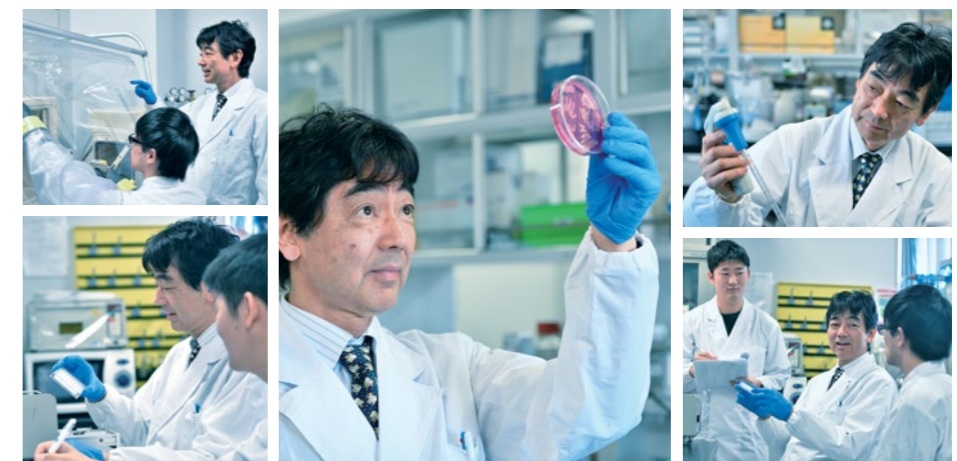

We have experimental results that show nanoe™ X is capable of inhibiting allergens, such as pollen and dust mites. It is important to take precautions against the allergens that we inadvertently inhale in our daily lives. As nanoe™ X is effective in inhibiting invisible allergens, we can expect it will create a cleaner environment. As the safety of nanoe™ X has also been verified, nanoe™ X gives peace of mind to families with small children.

^{*3} Experimental results show that nanoe™ X is effective in inhibiting the growth of the following types of mould and bacteria commonly found in homes:
 Mould: Trichophyton, Cladosporium, Malassezia furfur, Sporothrix schenckii, Exophiala jeanselmei, Absidia corymbifera, Rhodotorula rubra, Neurospora sitophila, Schizophyllum commune
 Bacteria: Methicillin-resistant Staphylococcus aureus (MRSA), Listeria monocytogenes, Bacillus subtilis, Mycobacterium smegmatis, Nocardia asteroides, Neisseria gonorrhoeae, Salmonella enterica subsp. Enterica, Haemophilus influenzae, Campylobacter jejuni.
^{*4} This verification was designed to generate basic research data on the effects of nanoe™ X on the mould and bacteria in laboratory conditions different from those found in living spaces. It was not designed to evaluate product performance.

Provide a New Gateway that Creates New Value for the Air Conditioning Business

Panasonic utilises advanced IoT technology and cloud service to provide new values that go beyond just cooling and heating solutions.



Employee



Biz Owner



Controller*/Adaptor



Administrator



Panasonic



Panasonic AC Smart Cloud



Panasonic AC Service Cloud

Cloud (New Gateway)



Shop Owner



Bldg. Owner



Owner's family



House Owner

Panasonic IoT Solution (Remote Controllers & App)

Delivering new value with heating and cooling and air quality solutions.

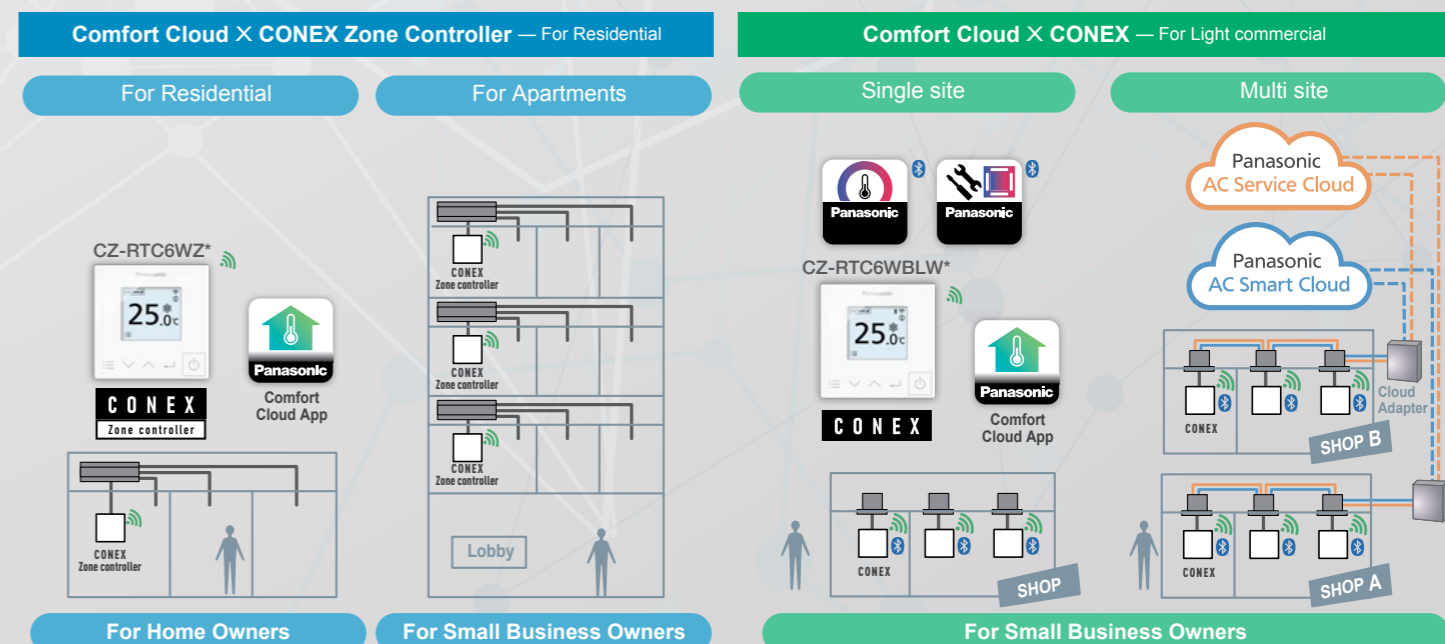

** If owners have a multisite business, they can also use Smart/Service Cloud for total management.

Comfort Cloud x CONEX* — For Light Commercial

Comfort Cloud x CONEX Zone Controller* — For Residential



Pre-Cool Your Office Before Arriving

To enjoy the most comfortable day at work, pre-cool it before reaching and be greeted with a cool and pleasant office.

Conveniently Turn All OFF/ON Easily

Never have to worry about individually switching OFF/ON your air conditioner units. With a tap, you can turn all your air conditioner OFF/ON.

Individual Comfort and Energy Saving

Airflow Volume Control

The damper opening can be controlled with the Comfort Cloud app. Adjust the air volume conveniently according to your daily life.

The living room damper opening is increased. For daily naps, reduce the air volume so that it doesn't get too cold.

Auto-optimised Comfort for Your Lifestyle

Weekly Timer

Able to set 6 timers/day. Realise optimal control day & night for your lifestyle with timers.

Pre-cool 30 minutes before going to bed, living zone off 30 minutes later. Cool your bedroom on weekend mornings to suit your oversleep.

Purifies Your Office with nanoe™ X

With the Comfort Cloud App, you can easily turn on the nanoe™ mode anytime, anywhere.

24-hour Air Purification

Group Status

Statistics

Purifies Your Room with nanoe™ X

24hr Clean Air

When you go out, clean the air with the nanoe™ mode. Pre-cool the living zone according to the time you return home.

24-hour Air Purification

Zone Status

Statistics

Requirements for Connecting with Panasonic Comfort Cloud App

External Adapter, Remote Controller Network

Other Hardware Requirements*

Router - Internet - Smartphone (Required 2.4GHz transmission channel)
 *Purchase and subscribe separately

Compatible Device and Browsers

- iOS 9.0 or above
- Android™ 5.0 Lollipop or later

Download Free App

Panasonic Comfort Cloud app

* New white model's scheduled release date is 4th Quarter in CY23. Note: Product images not to scale.

* New white model's scheduled release date is 4th Quarter in CY23. Note: Product images not to scale.

Smart comfort with CONEX

CONEX goes beyond simple remote control to combine sophistication with simplicity, offering IoT integration that connects directly to a variety of apps for next-generation solutions.

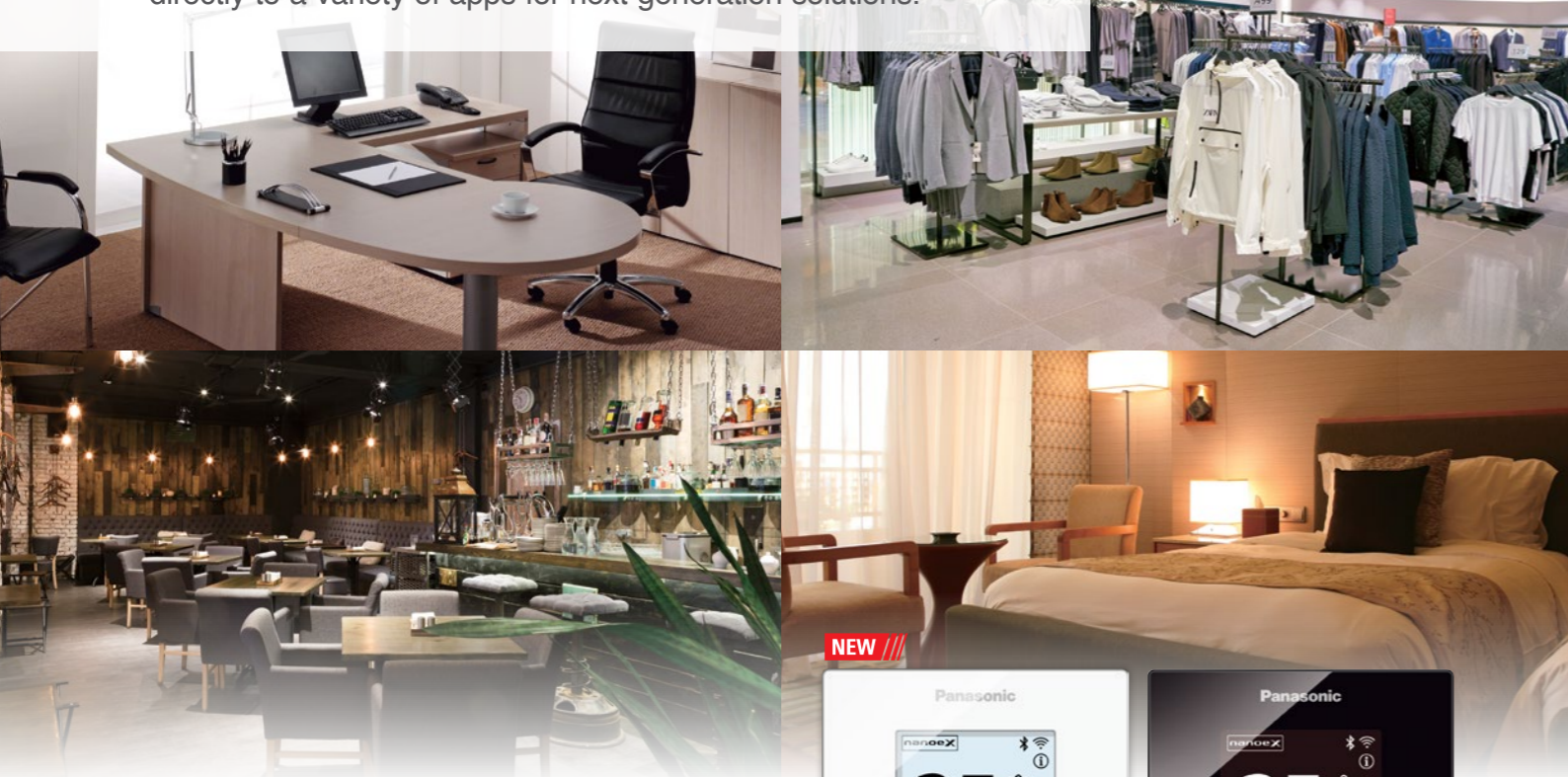

Simple and sophisticated design in-and-out

User friendly interface with stylish design measuring just 86 x 86 mm, CONEX is an extremely compact remote controller which looks great in any room.



Easy control and access for end users, installers, and service partners with just one remote

User-friendly day-to-day operation for end users, simplified set up for installers, and convenient after-sales service access for service partners - all with one remote control.



A next-generation remote control solution optimised for usability, whatever your needs

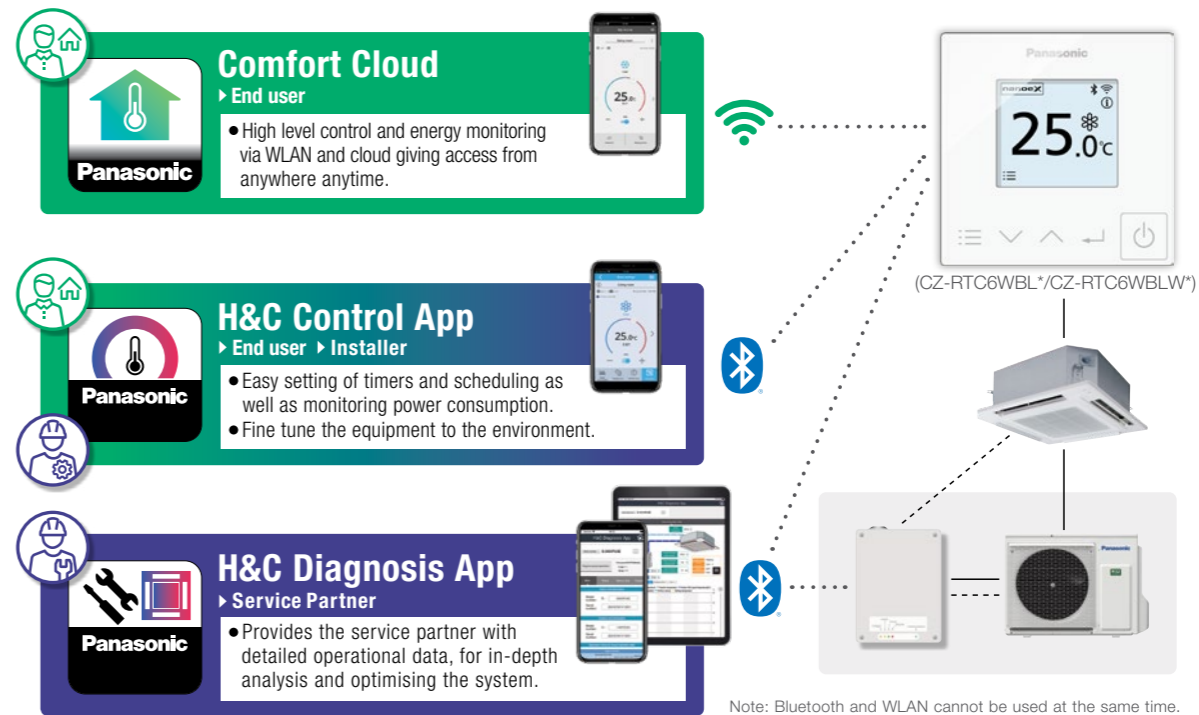

Note: Can be used with new NX series only.

* New white model's scheduled release date is 4th Quarter in CY23.

True-comfort for end user- Comfort Cloud App

With Comfort Cloud, even when you are out, at anytime, you can maintain air quality as you please.

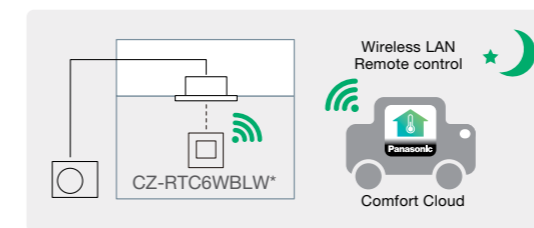

For restaurant owners

Remote control makes 24-hr nanoe™ X air purification*1 in restaurants a reality, even when they're closed.

For shop owners

Air conditioning before opening and give visitors a more comfortable experience.

For boutique hotel owners

Air conditioning before your guests arrive and give them the welcome they deserve.



*1 The nanoe™ X mode can be run independently from cooling or heating mode, and needs to be on for the 24 hour air purification to function.

Note: Product images not to scale.

True-comfort for end user and installer – H&C Control App

H&C Control App makes complex initial set-up easy and allows you to respond swiftly to clients' requests via Bluetooth using a smartphone or tablet.

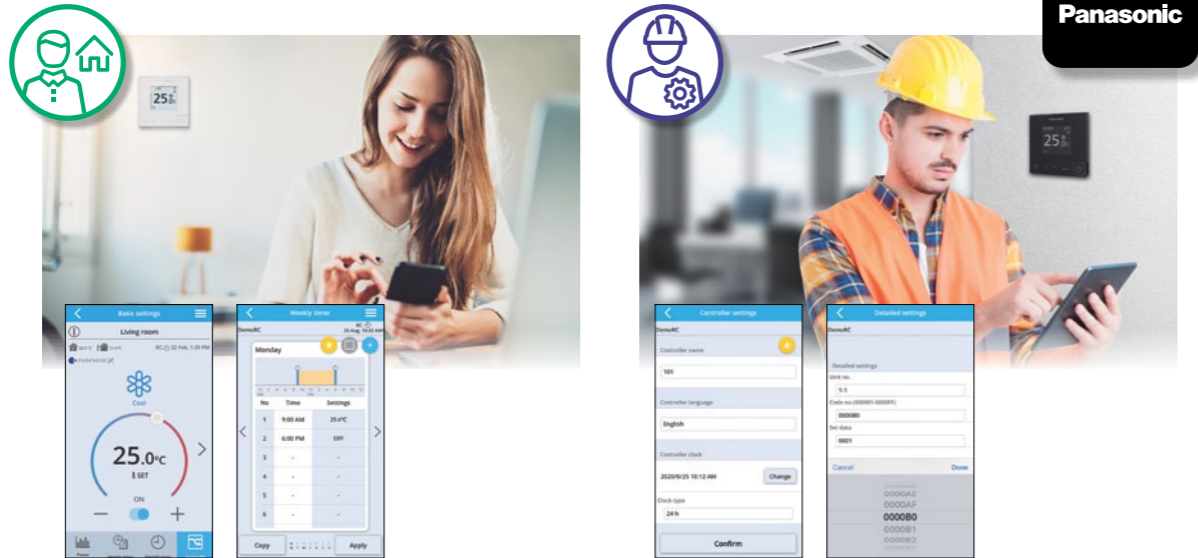

Advantages

Comfort day-to day operations

It's now simpler than ever for end users to further customise settings to meet their needs and perform operations including basic settings.

Intuitive operation for easy configuration

Simplified initial controller configuration together with easy access to comprehensive settings including weekly timer and maintenance.

Straightforward suggestions to clients

Share a single screen with your customer and together tailor, everything to meet their needs, from basic setup to weekly timers, all in real time.

Quicker configuration for multiple controllers

Save time with templates - Copy weekly timers and settings to multiple controllers.

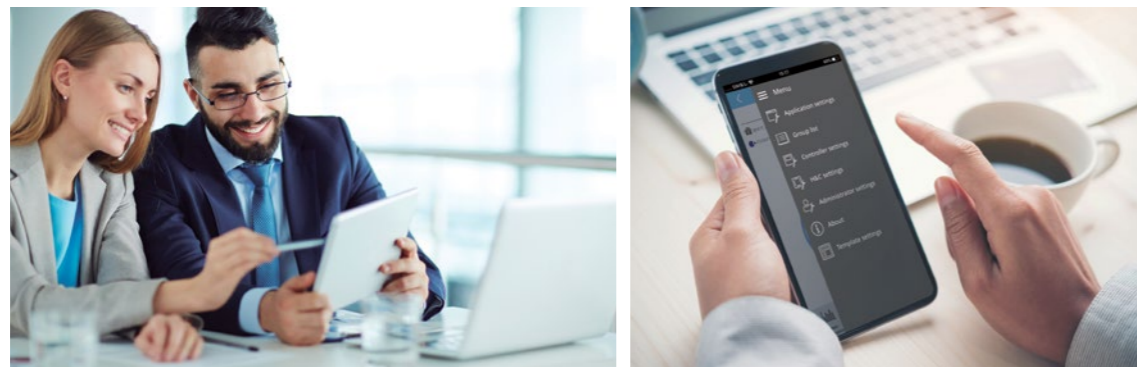

True-comfort for service partners – H&C Diagnosis App

The H&C Diagnosis App allows users to intuitively browse current stats and information about an air conditioner via Bluetooth® using a smartphone or tablet and without the need to use a PC.



Advantages

Acquire diagnostic information from both outside and inside

Outdoor diagnosis is now possible via a new service checker interface^{*1}. With CONEX, operation status can be checked and failure can be diagnosed from indoors too. The information you need is now available via both indoor and outdoor units even when site access may be difficult for either indoor or outdoor unit.

^{*1} Available as a spare part, compatible with new NX series only.

Acquire the information you need intuitively and quickly

Easy access to real-time service parameters and service checker data allows for more accurate repairs. Actual real-time operation data can be toggled between system and refrigerant circuit views, and previously recorded data can be viewed in the history.

A comprehensive error code table and guide gives details of error codes and how to handle them.



Refrigerant circuit view

Real time data

History data



New service checker interface

Next Generation One-touch Control, Anytime, Anywhere

Air conditioning for each zone anytime, anywhere according to your needs. Enabled by the fusion of Panasonic's IoT technology and cloud service.

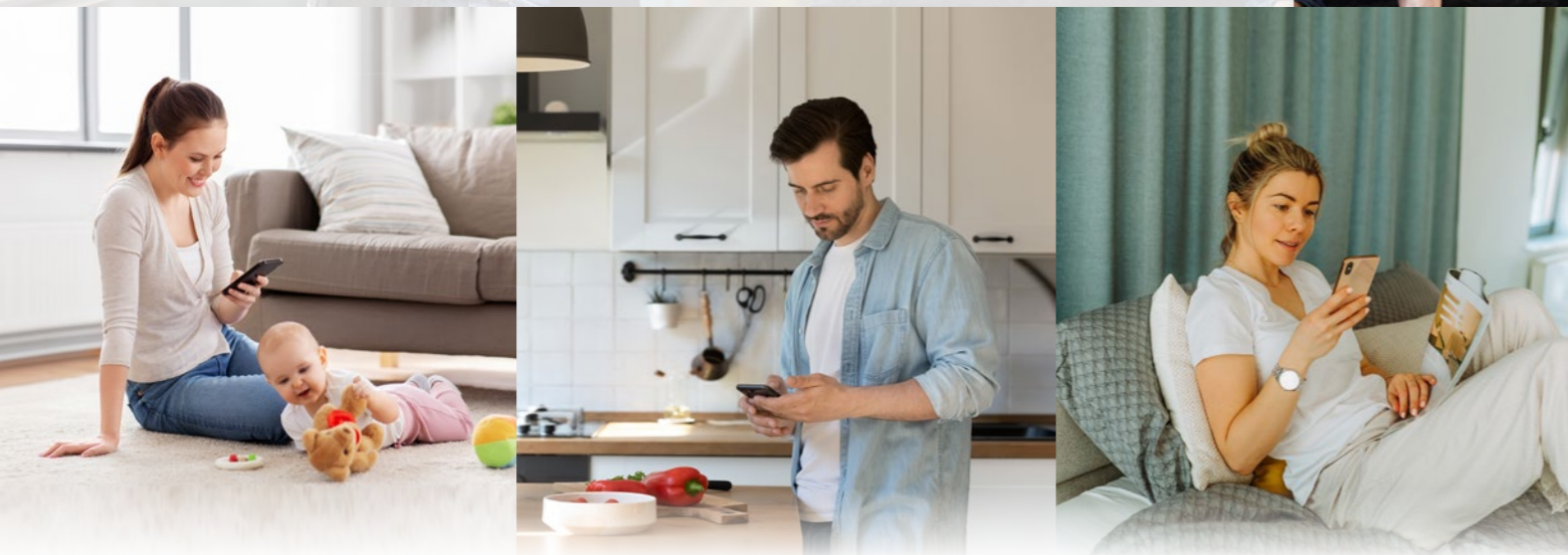

Comfortable Zone Air Conditioning with Stress-free Operation



Individual comfort

•Airflow volume control

The damper opening can be controlled with the Comfort Cloud App. Easily adjust airflow volume according to your lifestyle.

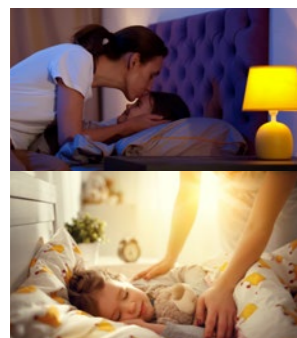

Auto optimised comfort for your lifestyle

•Weekly timer

You can set 6 timers per day. Use timers to enjoy optimal control day and night to match your lifestyle.

NEW



Enable comfort for whole family

•Target temperature control

The temp targeted zone can be switched easily according to how you and your family spend time, making the whole family comfortable.

Manage Up to 8 Zones with an Advanced Zone Control System

CONEX Zone Controller



Product movie

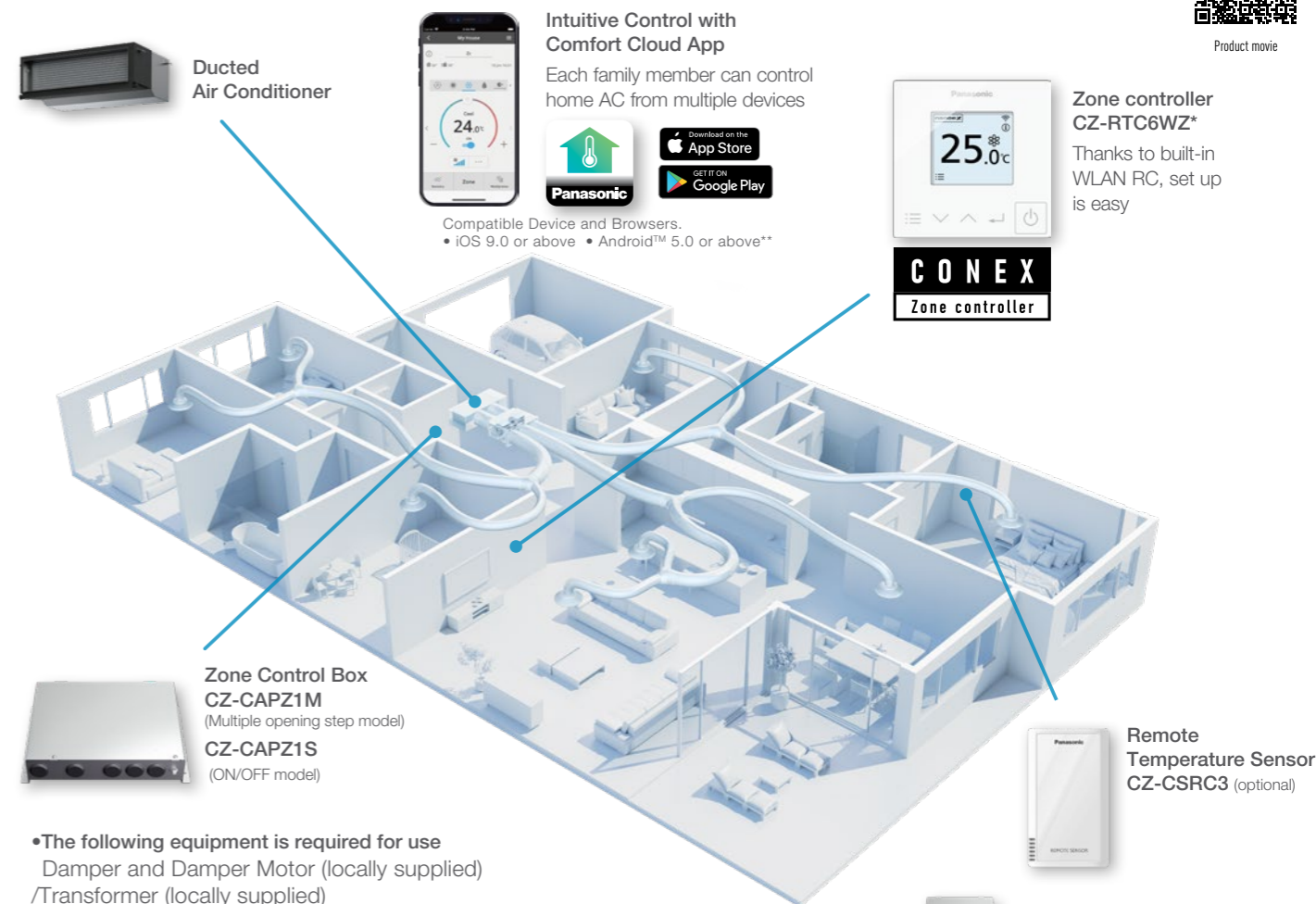

•The following equipment is required for use
Damper and Damper Motor (locally supplied)
/Transformer (locally supplied)

Zone Remote Controller

Spec & dimensions

Model No.	CZ-RTC6WZ*
Dimensions	(H) 86 mm x (W) 86 mm x (D) 25 mm
Weight	0.10 kg
Temperature / Humidity range	0°C to 40°C / 20% to 80% (No condensation) • Indoor use only.
Power Source	DC16 V (supplied from indoor unit)
Wireless LAN standard	IEEE 802.11 b/g/n
Frequency range	2.4 GHz band
Encryption	WPA2-PSK (TKIP/AES)
OS version on the mobile device for CFC	iOS: 9.0 or later AndroidTM: 5.0 or later

Zone Control Box

Spec & dimensions

Model No.	CZ-CAPZ1S/CZ-CAPZ1M
Dimensions	(H) 250 mm x (W) 342 mm x (D) 70 mm
Weight	1.9 kg

Remote Temperature Sensor

Spec & dimensions

Model No.	CZ-CSRC3
Dimensions	(H) 120 mm x (W) 70 mm x (D) 17 mm
Weight	70 g
Temperature / Humidity range	0°C to 40°C / 20% to 80% (No condensation) • Indoor use only.

Usable indoor units

Zone Controller can be connected with 3.6 kW to 22.4 kW Ducted (PE3, PF3 and PE4) Indoors and VRF Ducted units (M1, E1, E2, E1R, F2, F3 and Z1).

*Connectable to selected Panasonic ducted models only, please consult Panasonic for more details.

Series	PE4	PE3	PF3	MM1	ME1	ME2	ME1R	MF2	MF3	MZ1
Capacity	18.0 kW-22.0 kW	6.0 kW-22.4 kW	3.6 kW-14.0 kW	2.2 kW-5.6 kW	7.3 kW-14.0 kW	18.0 kW-28.0 kW	9.0 kW-16.0 kW	2.2 kW-16.0 kW		2.2 kW-7.3 kW

Note: Product images not to scale.

** iOS is the name of the OS of Apple Inc. iOS is a trademark or registered trademark of Cisco in the US and other countries where it is licensed for use. Apple and the Apple logo are trademarks of Apple Inc. that are registered in the US and other countries. App Store is a service mark of Apple Inc. ** Android™, Google Play™ and Google Play™ logos are registered trademarks of Google LLC.

All side discharge R32 outdoor units

Panasonic's new range of outdoor units feature intuitive technology and thoughtful engineering. The two innovative ranges of R32 units, both Deluxe and Compact, feature energy and space saving technologies, permitting installation in even the tightest and most demanding conditions.



More Efficient, Less Space

Whilst maintaining its strong power, new R32 outdoor units get smaller. This enables them to fit into tighter spaces. Thus you can install these units in a vast variety of areas.

All side discharge from 6.0kw to 22.4kW

R32 Deluxe



Industry-leading Small Body with All 1-fan Models

R32 Compact

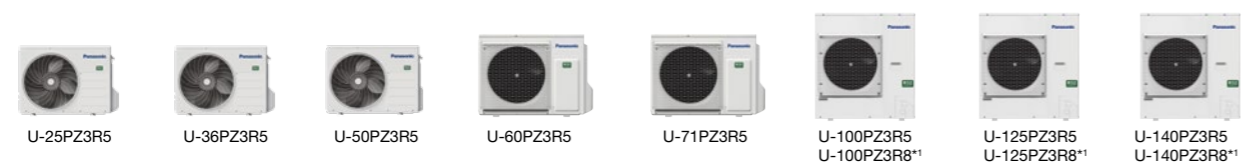

**1 3 phase

NX Series - Refurbishing Made Easy

The new NX series has been developed to use 3-wired communication, making it simple to replace the three wire systems often used in older installations.

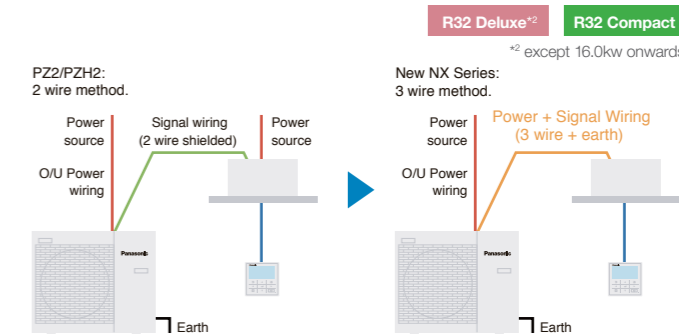

Next Generation Refrigerant: R32

R32, an innovative refrigerant in all ways imaginable: it is easy to install, and compared to most other refrigerants it has a much lower environmental impact and saves energy.

- Low Global Warming Potential (GWP): 75% less impact on global warming vs R410A
- Energy Efficient: Higher energy efficiency than R410A
- Easy Installation: This refrigerant is 100% pure which makes it easier to recycle and reuse.

Other Advanced Technology

Increased Piping Length for Greater Design Flexibility

R32 Deluxe

Adaptable to various building types and sizes

- Max. piping length :
- 50m (7.1kW),
 - 85m (10.0kW-14.0kW),
 - 75m (16.0kW, 18.0kW)
 - 60m (20.0kW, 22.4kW)

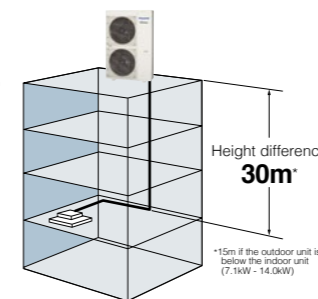

Product Quality and Safety

R32 Compact R32 Deluxe

All Panasonic air conditioners undergo strict quality and safety tests before sale. This rigorous process includes obtaining all necessary Safety Approvals, to ensure that all air conditioners we sell are not only built to the highest market standards, but are also completely safe.



Quiet Mode

R32 Compact R32 Deluxe

Quiet mode reduces outdoor operating sound by 2dB. External input signal is also available.

Demand Response Compliant

R32 Compact R32 Deluxe

Panasonic air conditioners are equipped with a Demand Response Enabling Device (DRED) which complies to both AS 4755 and AS 3823. Panasonic continues to design and develop products that are tailored to local needs and requirements.

The Equipment Energy Efficiency (E3) program has been supporting the development of DRED standards for air-conditioners which should comply with AS 4755. The functionality will be required for all installations in the very near future

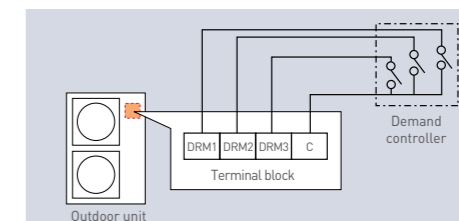

Demand control terminal is available to control 0-50-75-100% of capacities.

Indoor Unit High Static Pressure Ducted

High static and large airflow ducted for exceptional installation flexibility.

nanoe™ X
Generator Mark2
nanoe™ X as a standard

- 
Self-diagnosing Function
- 
Automatic Fan Operation
- 
Dry Mode
- 
Automatic Restart Function
- 
DC Motor*
*1 only for 6.0-12.5kw



*1 Launched in 4th Quarter in CY23. Black models are also available.
*2 Zone Controller for residential use.
Note: Product image not to scale.

Technical focus

- Design flexibility thanks to high static pressure and large air volume
- Configurable air temperature control
- Accurate temperature control to reduce cold drafts during operation

Compact Body Size

Hidden in the ceiling, ideal when interior decor is an important consideration such as in residences with many rooms and light commercial buildings.

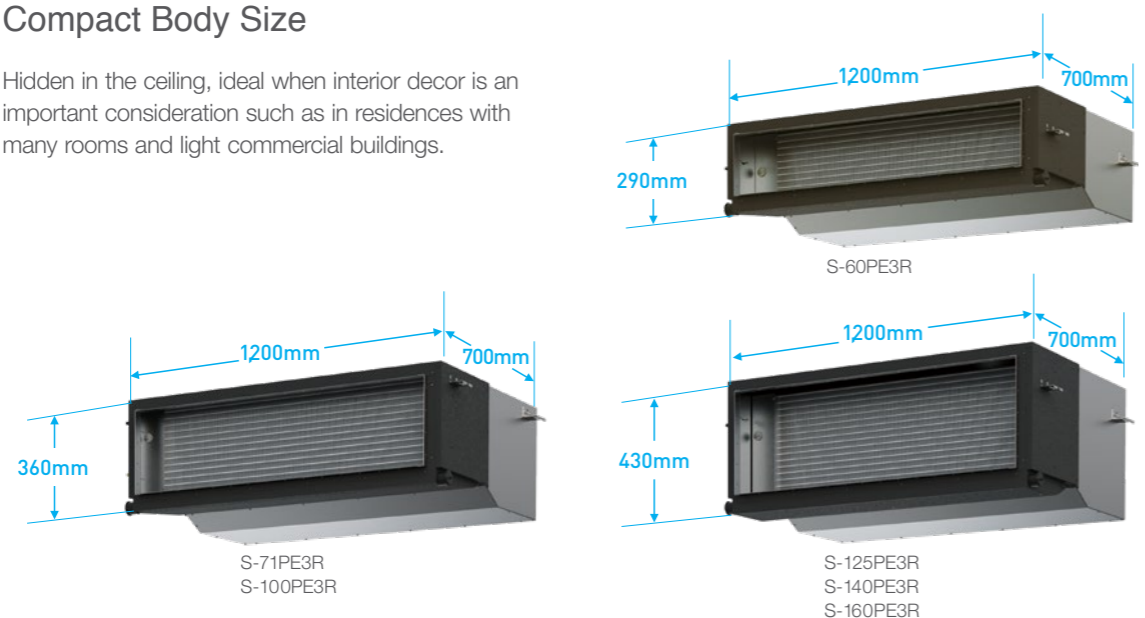

Clean air. Ducts that deliver

Testing has verified that even with three bends and a total length of up to 10m, the effectiveness of nanoe™ X is maintained right through the duct to deliver clean, fresh air where it's needed.

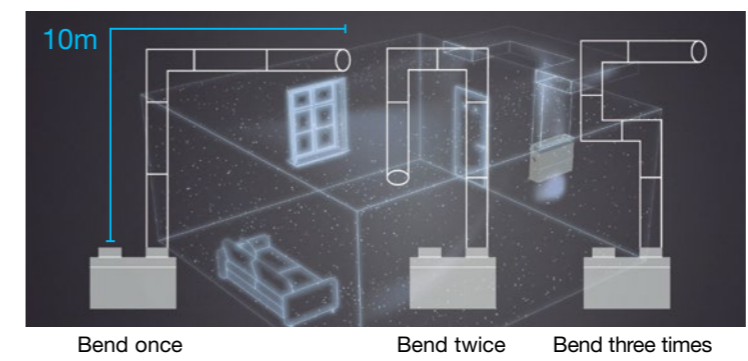

As the experiments demonstrate; even with a total ductwork length of up to 10m, effectiveness of nanoe™ X is maintained.
Note: PF3 and PE3 (16.0kW and below) ranges only.

Cold Drafts Reduced During Heating Operation

- Accurate temperature measurement by E1/E2 sensor to reduce cold drafts during heating operation.

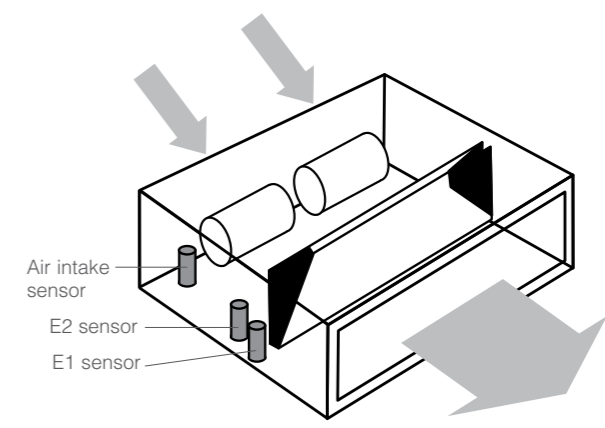

System Example

An inspection port (450 mm x 450 mm or more) is required at the control-box side of the indoor unit body.

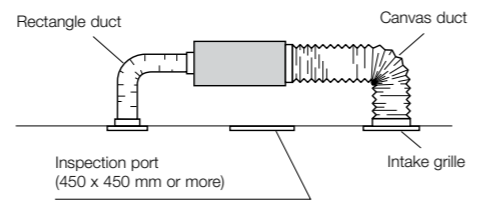

Indoor Unit: High Static Pressure Ducted

High Static Pressure Duct R32 Deluxe model



Capacity		7.1kW		10.0kW		12.5kW		14.0kW		16.0kW	
Model Name	Indoor Unit	S-71PE3R	S-100PE3R	S-125PE3R	S-150PE3R	S-125PE3R	S-150PE3R	S-140PE3R	S-160PE3R	S-160PE3R	S-160PE3R
	Outdoor Unit	U-71PZH3R5	U-100PZH3R5	U-100PZH3R8	U-125PZH3R5	U-125PZH3R8	U-140PZH3R5	U-140PZH3R8	U-160PZH3R5	U-160PZH3R8	U-160PZH3R8
Cooling capacity : Heating capacity	kW	7.1 (2.2 - 9.0) 8.0 (2.0 - 9.0)	10.0 (3.1 - 12.5) 11.2 (3.1 - 14.0)	10.0 (3.1 - 12.5) 11.2 (3.1 - 14.0)	12.5 (3.2 - 14.0) 14.0 (3.2 - 16.0)	12.5 (3.2 - 14.0) 14.0 (3.2 - 16.0)	14.0 (3.3 - 16.0) 16.0 (3.3 - 18.0)	14.0 (3.3 - 16.0) 16.0 (3.3 - 18.0)	16.0 (5.2-18.0) 18.0 (5.5-20.0)	16.0 (5.2-18.0) 18.0 (5.5-20.0)	16.0 (5.2-18.0) 18.0 (5.5-20.0)
	BTU/h	24,200 (7,500 - 30,700) 27,300 (6,800 - 30,700)	34,100 (10,600 - 42,700) 38,200 (10,600 - 47,800)	34,100 (10,600 - 42,700) 38,200 (10,600 - 47,800)	42,700 (10,900 - 47,800) 47,800 (10,900 - 54,600)	42,700 (10,900 - 47,800) 47,800 (10,900 - 54,600)	47,800 (11,300 - 54,600) 54,600 (11,300 - 61,400)	47,800 (11,300 - 54,600) 54,600 (11,300 - 61,400)	54,600 (17,700-61,400) 61,400 (18,800-68,200)	54,600 (17,700-61,400) 61,400 (18,800-68,200)	54,600 (17,700-61,400) 61,400 (18,800-68,200)
EER : COP	W/W	3.48 : 3.88	3.79 : 3.78	3.79 : 3.78	3.57 : 3.80	3.57 : 3.80	3.26 : 3.68	3.26 : 3.68	3.29 : 3.53	3.29 : 3.53	
COP@H2 condition	W/W	2.80	2.77	2.77	2.72	2.72	2.65	2.65	2.81	2.81	
Total power input	kW	2.04 : 2.06	2.64 : 2.96	2.64 : 2.96	3.50 : 3.68	3.50 : 3.68	4.30 : 4.35	4.30 : 4.35	4.86 : 5.10	4.86 : 5.10	
TCSPF : HSPF	Residential	Cooling : Heating	4.11 : 4.22	4.46 : 4.34	4.46 : 4.34	4.49 : 4.40	4.49 : 4.40	3.92 : 4.07	3.92 : 4.07	4.03 : 3.89	4.03 : 3.89
		Hot Climate	4.68 : 4.82	5.04 : 5.10	5.04 : 5.10	4.92 : 5.17	4.92 : 5.17	4.29 : 4.69	4.29 : 4.69	4.48 : 4.43	4.48 : 4.43
		Cold Climate	4.19 : 3.79	4.54 : 3.93	4.54 : 3.93	4.60 : 3.90	4.60 : 3.90	4.03 : 3.62	4.03 : 3.62	4.08 : 3.49	4.08 : 3.49
	Commercial	Cooling : Heating	5.15 : 4.85	5.55 : 5.15	5.55 : 5.15	5.36 : 5.23	5.36 : 5.23	4.63 : 4.74	4.63 : 4.74	5.03 : 4.43	5.03 : 4.43
		Hot Climate	5.00 : 4.52	5.47 : 4.73	5.47 : 4.73	5.55 : 4.80	5.55 : 4.80	4.60 : 4.39	4.60 : 4.39	5.22 : 4.13	5.22 : 4.13
		Cold Climate	5.37 : 4.11	5.87 : 4.32	5.87 : 4.32	5.97 : 4.31	5.97 : 4.31	4.91 : 3.96	4.91 : 3.96	5.79 : 3.77	5.79 : 3.77

Specifications of R32 Compact Model



Capacity		6.0kW		7.1kW		10.0kW		12.5kW		14.0kW	
Model Name	Indoor Unit	S-60PE3R	S-71PE3R	S-100PE3R	S-100PE3R	S-125PE3R	S-125PE3R	S-140PE3R	S-140PE3R	S-140PE3R	S-140PE3R
	Outdoor Unit	U-60PZ3R5	U-71PZ3R5	U-100PZ3R5	U-100PZ3R8	U-125PZ3R5	U-125PZ3R8	U-140PZ3R5	U-140PZ3R8	U-140PZ3R8	U-140PZ3R8
Cooling capacity : Heating capacity	kW	6.0 (2.0 - 7.1) 6.0 (1.8 - 7.0)	7.1 (2.6 - 7.7) 7.1 (2.1 - 8.1)	10.0 (3.0 - 11.5) 10.0 (3.0 - 14.0)	10.0 (3.0 - 11.5) 10.0 (3.0 - 14.0)	12.5 (3.2 - 13.5) 12.5 (3.3 - 15.0)	12.5 (3.2 - 13.5) 12.5 (3.3 - 15.0)	14.0 (3.3 - 15.0) 14.0 (3.4 - 16.0)	14.0 (3.3 - 15.0) 14.0 (3.4 - 16.0)	14.0 (3.3 - 15.0) 14.0 (3.4 - 16.0)	14.0 (3.3 - 15.0) 14.0 (3.4 - 16.0)
	BTU/h	20,500 (6,800 - 24,200) 24,200 (6,100 - 23,900)	24,200 (8,900 - 26,300) 24,200 (7,200 - 27,600)	34,100 (10,200 - 39,200) 34,100 (10,200 - 47,800)	34,100 (10,200 - 39,200) 34,100 (10,200 - 47,800)	42,700 (10,900 - 46,100) 42,700 (11,300 - 51,200)	42,700 (10,900 - 46,100) 42,700 (11,300 - 51,200)	47,800 (11,300 - 51,200) 47,800 (11,600 - 54,600)	47,800 (11,300 - 51,200) 47,800 (11,600 - 54,600)	47,800 (11,300 - 51,200) 47,800 (11,600 - 54,600)	47,800 (11,300 - 51,200) 47,800 (11,600 - 54,600)
EER : COP	W/W	3.26 : 4.08	3.21 : 4.25	3.58 : 4.08	3.58 : 4.08	3.55 : 4.03	3.55 : 4.03	3.25 : 3.76	3.25 : 3.76	3.25 : 3.76	
COP@H2 condition	W/W	3.00	3.11	2.88	2.88	2.56	2.56	2.68	2.68	2.68	
Total power input	kW	1.84 : 1.47	2.21 : 1.67	2.79 : 2.45	2.79 : 2.45	3.52 : 3.10	3.52 : 3.10	4.31 : 3.72	4.31 : 3.72	4.31 : 3.72	
TCSPF : HSPF	Residential	Cooling : Heating	3.98 : 3.95	3.96 : 4.05	4.64 : 3.95	4.64 : 3.95	4.60 : 3.93	4.60 : 3.93	4.27 : 3.79	4.27 : 3.79	4.27 : 3.79
		Hot Climate	3.56 : 3.88	3.59 : 4.00	4.17 : 3.81	4.17 : 3.81	4.16 : 3.79	4.16 : 3.79	3.92 : 3.64	3.92 : 3.64	3.92 : 3.64
		Cold Climate	3.58 : 3.59	3.63 : 3.70	4.23 : 3.55	4.23 : 3.55	4.26 : 3.47	4.26 : 3.47	4.03 : 3.34	4.03 : 3.34	4.03 : 3.34
	Commercial	Cooling : Heating	4.25 : 3.83	4.22 : 3.91	4.99 : 3.90	4.99 : 3.90	4.96 : 3.84	4.96 : 3.84	4.56 : 3.70	4.56 : 3.70	4.56 : 3.70
		Hot Climate	4.16 : 3.74	4.19 : 3.83	4.98 : 3.80	4.98 : 3.80	4.88 : 3.73	4.88 : 3.73	4.53 : 3.58	4.53 : 3.58	4.53 : 3.58
		Cold Climate	4.38 : 3.58	4.41 : 3.67	5.28 : 3.61	5.28 : 3.61	5.20 : 3.52	5.20 : 3.52	4.81 : 3.40	4.81 : 3.40	4.81 : 3.40

- Notes:
- In the case of nanoe X OFF
 - In case it is necessary to indicate the air flow volume in (l/s), the value in (m³/min.) shall be multiplied by 16.7 and rounded down the decimal point.
 - AEER and ACOP classification is at 230V(400V) only in accordance with GEMS2019.
 - TCSPF, HSPF and Total Energy consumption indicate the value of average temperature zone.
 - Indoor and outdoor sound levels are determined in an anechoic chamber and may differ once the unit is installed due to ambient conditions.
- *1 Outdoor power supply.
*2 Not adjustable, refer to "Indoor Fan Performance" section of technical data.
*3 For piping connection for 6.0kW unit, connect the gas socket tube (Ø12.7-Ø15.88) to the gas tubing side indoor unit and connect the liquid socket tube (Ø6.35-Ø9.52) to the liquid tubing side indoor unit.
*4 For piping connection for 7.1kW unit, connect the liquid socket tube (Ø6.35-Ø9.52) to the liquid tubing side indoor unit.

Indoor Unit High Static Pressure Splittable Ducted

High static and large airflow ducted for exceptional installation flexibility.

nanoe™ X
Generator Mark3
nanoe™ X as a standard



S-180PE4R
S-200PE4R
S-224PE4R



CZ-RTC6WBL*1 CZ-RTC6WZ*1*2 CZ-RTC5B CZ-RTC4 CZ-CAPWFC1

*1 Launched in 4th Quarter in CY23. Black models are also available.
*2 Zone Controller for residential use.
Note: Product image not to scale.

- Self-diagnosing Function
- Automatic Fan Operation
- DRY
- Automatic Restart Function
- DC Motor

Technical focus

- Easy installation with splittable chassis design
- Max. 200Pa static pressure setting*1
- Design flexibility thanks to high static pressure and large air volume
- DC motor equipped
- Low power input
- Accurate temperature control to reduce cold drafts during operation
- Configurable air temperature control

*1 In case of S-224PE4R

New Ducted Model Key Factors

Bell Shaped Keyhole for Weight Support

Part of the keyhole is newly designed with a bell shape to reduce the burden of installation. It also enables temporary attachment.



2 Wire Connectors for Easy Installation

With only 2 wire connectors, installation has become much easier and faster.



12 Bolts & Screws for Easy Assembly

Only 12 screws and bolts need to be attached, allowing for a shorter installation time.

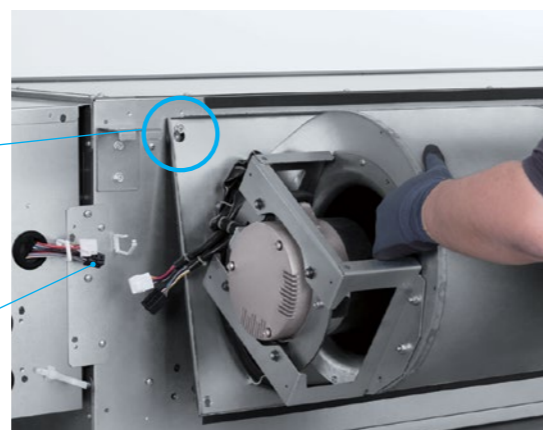

Easy Assembly Steps

Assembly takes three easy steps, even in limited spaces.

- 1 Install the fan to the heat exchanger and tighten the screws and bolts.
- 2 Assemble the connectors.
- 3 Install the chassis and tighten the screws and bolts.

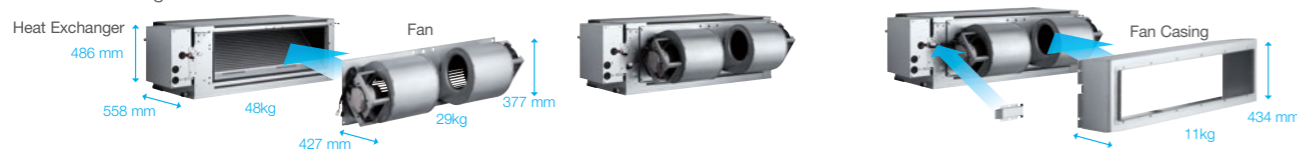

Note: Above images are for the 22.4kW model.

Specifications of R32 Deluxe Model



Capacity		18.0kW		20.0kW		22.4kW					
Model Name	Indoor Unit	S-180PE4R	S-180PE4R	S-200PE4R	S-224PE4R	Outdoor Unit	U-180PZH3R5	U-180PZH3R8	U-200PZH3R8	U-224PZH3R8	
Cooling Capacity :	kW	18.0 (5.5-20.0)	18.0 (5.5-20.0)	20.0 (5.7-22.4)	22.4 (5.7-25.0)						
Heating Capacity	BTU/h	61,400 (18,800-68,200)	61,400 (18,800-68,200)	68,200 (17,100-85,300)	76,400 (19,400-85,300)						
EER : COP	W/W	3.20 : 3.75	3.20 : 3.75	3.33 : 3.67	3.09 : 3.52						
COP@H2 condition	W/W	2.9	2.9	2.7	2.6						
Total power input	Cooling : Heating	5.63 : 5.33	5.63 : 5.33	6.00 : 6.10	7.24 : 7.10						
TCSPF : HSPF	Residential	Hot Climate	4.33 : 4.95	4.33 : 4.95	4.33 : 4.42	4.00 : 4.55					
		Average Climate	3.93 : 4.24	3.93 : 4.24	3.97 : 3.90	3.69 : 3.87					
		Cold Climate	4.03 : 3.72	4.03 : 3.72	4.05 : 3.45	3.79 : 3.38					
		Commercial	Hot Climate	4.73 : 4.99	4.73 : 4.99	4.65 : 4.44	4.27 : 4.68				
		Average Climate	4.76 : 4.58	4.76 : 4.58	4.71 : 4.14	4.31 : 4.29					
		Cold Climate	5.12 : 4.10	5.12 : 4.10	5.01 : 3.74	4.57 : 3.78					
Indoor Unit											
Power source	Phase/Hz	1 Phase / 50Hz		1 Phase / 50Hz		1 Phase / 50Hz		1 Phase / 50Hz		1 Phase / 50Hz	
	V	230V 240V		230V 240V		230V 240V		230V 240V		230V 240V	
Current (rated)	Cooling : Heating	3.30 : 3.30	3.20 : 3.20	3.30 : 3.30	3.30 : 3.30	4.20 : 4.20	4.10 : 4.10	4.10 : 4.10	4.10 : 4.10	4.10 : 4.10	
Dimension	H x W x D	486 x 1456 x 916		486 x 1456 x 916		486 x 1456 x 916		486 x 1456 x 916		486 x 1456 x 916	
Net Weight	Indoor	82		82		83		87		87	
Air volume (H/M/L)	Cooling : Heating	1,202 / 1,052 / 885 : 1,202 / 1,052 / 885		1,202 / 1,052 / 885 : 1,202 / 1,052 / 885		1,202 / 1,052 / 885 : 1,202 / 1,052 / 885		1,402 / 1,202 / 985 : 1,402 / 1,202 / 985		1,402 / 1,202 / 985 : 1,402 / 1,202 / 985	
External static pressure	Pa	60 (100 / 150)		60 (100 / 150)		75 (120 / 180)		75 (130 / 200)		75 (130 / 200)	
Sound Pressure Level (H/M/L)	Cooling : Heating	46 / 44 / 41 : 46 / 44 / 41		46 / 44 / 41 : 46 / 44 / 41		46 / 44 / 41 : 46 / 44 / 41		47 / 45 / 42 : 47 / 45 / 42		47 / 45 / 42 : 47 / 45 / 42	
Sound Power Level (H/M/L)	Cooling : Heating	78 / 76 / 73 : 78 / 76 / 73		78 / 76 / 73 : 78 / 76 / 73		78 / 76 / 73 : 78 / 76 / 73		79 / 77 / 74 : 79 / 77 / 74		79 / 77 / 74 : 79 / 77 / 74	
Number of fan speeds		3		3		3		3		3	
Drain piping	mm	VP-25		VP-25		VP-25		VP-25		VP-25	
Outdoor											
Power source	Phase/Hz	1 Phase / 50Hz		3 Phase / 50Hz		3 Phase / 50Hz		3 Phase / 50Hz		3 Phase / 50Hz	
	V	230V 240V		400V 415V		400V 415V		400V 415V		400V 415V	
Current (rated)	Cooling : Heating	23.3 : 21.9 22.3 : 21.0		8.00 : 7.50 7.70 : 7.25		8.45 : 8.60 8.15 : 8.30		9.95 : 9.75 9.60 : 9.40		9.95 : 9.75 9.60 : 9.40	
Dimension	H x W x D	1,500 x 980 x 370		1,500 x 980 x 370		1,500 x 980 x 370		1,500 x 980 x 370		1,500 x 980 x 370	
Net weight	kg	117		115		127		127		127	
Air volume	Cooling : Heating	2,738 : 2,738		2,738 : 2,738		2,672 : 2,672		2,672 : 2,672		2,672 : 2,672	
Sound Pressure Level (Silent mode)	Cooling : Heating	58 : 60		58 : 60		58 : 62		58 : 62		58 : 62	
Sound Power Level (Silent mode)	Cooling : Heating	76 : 78		76 : 78		77 : 81		77 : 81		77 : 81	
Piping Connection	Liquid / Gas	Ø9.52 / Ø19.05		Ø9.52 / Ø19.05		Ø12.7 / Ø19.05		Ø12.7 / Ø19.05		Ø12.7 / Ø19.05	
Pipe Length range	min. - max.	5 - 100		5 - 100		5 - 100		5 - 100		5 - 100	
Elevation Difference (OU located lower, OU located higher)	m	30, 30		30, 30		30, 30		30, 30		30, 30	
Maximum Chargeless length	m	30		30		30		30		30	
Refrigerant at shipping / Additional gas amount	g	R32 3,400 / 76.0 (g/m)		R32 3,400 / 76.0 (g/m)		R32 5,200 / 108.0 (g/m)		R32 5,200 / 108.0 (g/m)		R32 5,200 / 80 (g/m)	
Operation Ranges	Cooling : Heating	-15 to 46 : -20 to 24		-15 to 52 : -20 to 24		-15 to 52 : -20 to 24		-15 to 52 : -20 to 24		-15 to 46 : -20 to 24	

Notes:

- In the case of nanoe X OFF
- In case it is necessary to indicate the air flow volume in (l/s), the value in (m³/min.) shall be multiplied by 16.7 and rounded down the decimal point.
- AEER and ACOP classification is at 230V(400V) only in accordance with GEMS2019.
- TCSPF, HSPF and Total Energy consumption indicate the value of average temperature zone.
- Indoor and outdoor sound levels are determined in an anechoic chamber and may differ once the unit is installed due to ambient conditions

*1 For U-160PZH3R8 *2 For U-180PZH3R8

Indoor Unit

High Static Pressure

Adaptive Ducted

Control all aspects of your environment with exceptional performance and quiet operation. Vertical installation flexibility offers the perfect solution when ceiling heights are restricted.

nanoe™ X
Generator Mark2
nanoe™ X as a standard

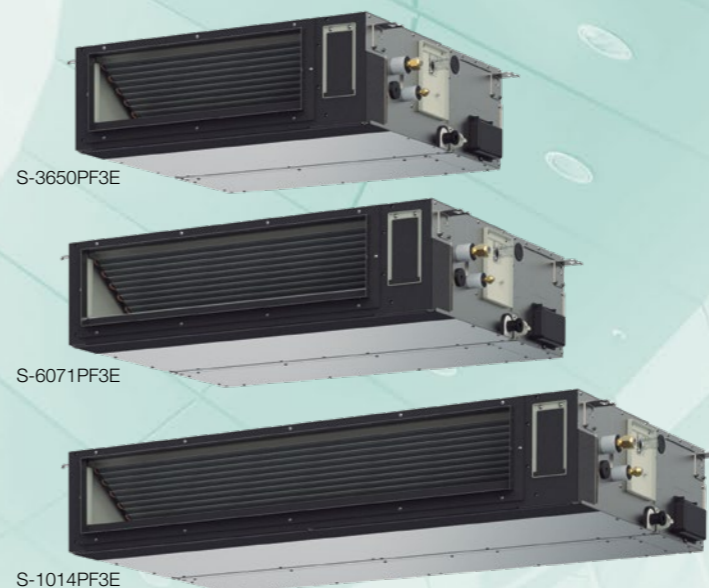

MSP Ducted



Product movie

*1 Launched in 4th Quarter in CY23. Black models are also available.
*2 Zone Controller for residential use.
Note: Product image not to scale.

Technical focus

- Space saving 250mm height
- DC fan motor for variable external static pressure control
- Easy to install and maintain
- Accurate temperature control to reduce cold drafts during operation
- Configurable air temperature control

Powerful 150Pa ESP in an industry-leading vertical installation

Our groundbreaking drain pan design delivers a ducted unit that can be mounted horizontally or vertically without the need for alterations*1. Even when ceiling space for ductwork is limited, the slim design and powerful 150Pa static pressure allow for discrete placement away from rooms for total installation flexibility.

*1 Please refer to Installation Manual for full details.

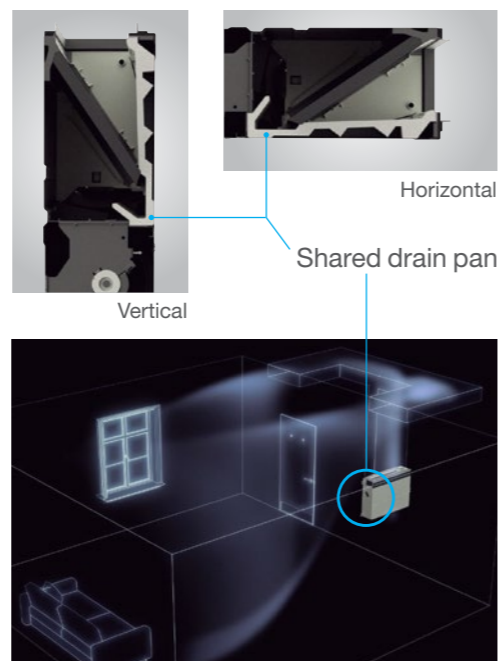

Drain pan is shared in both cases horizontal and vertical installation.

Selectable air inlet position

A removable panel allows air inlet position to be adjusted to enable rear or bottom entry, depending on ductwork installation.

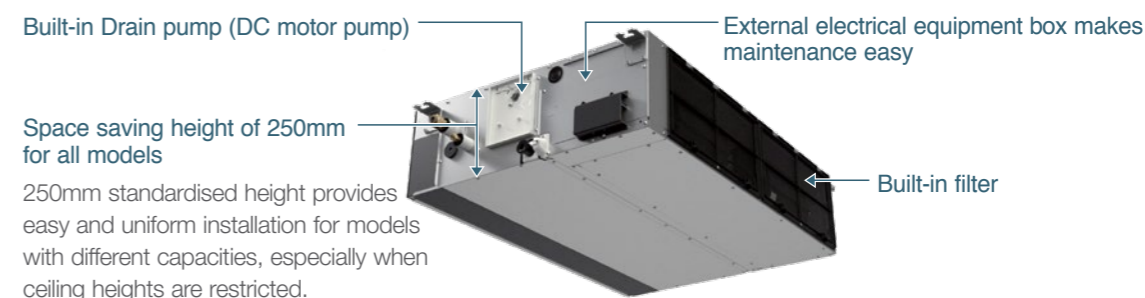
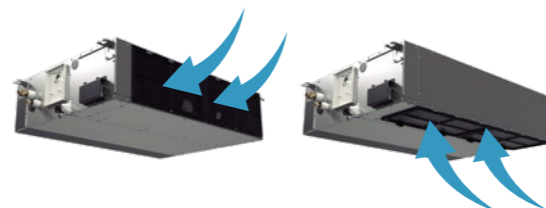

Top-class noise level performance

A proprietary improved casing design realises an even smoother airflow and low noise (22dB - 29dB) operation while effortlessly maintaining enough pressure*2 to deliver quiet comfort ideal for hotel and guest rooms.

*2 Operating at 50Pa static pressure in Low fan mode.

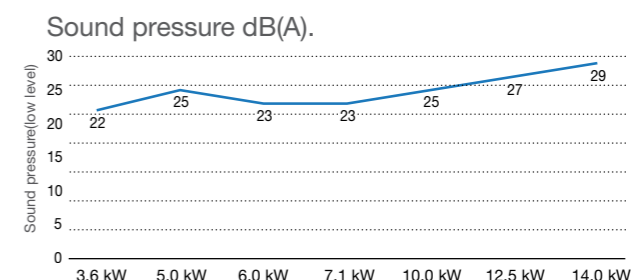
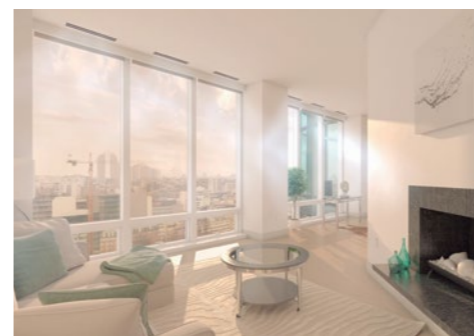
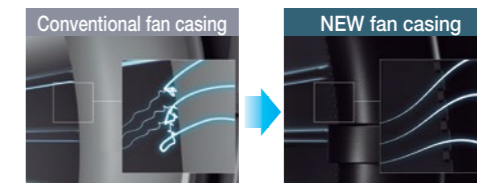

Note: Silent operation in full rated capacity.

Superior air quality



The new ducted models are equipped with nanoe™ X as standard, a unique air quality improvement technology producing twice the amount of hydroxyl radicals compared to previous generations. Combined with the strong static pressure this ensures pristine nanoe™ X air travels unaffected even through multiple duct shapes at lengths of 10m, as well as making them ideal for use in larger spaces.

Note: PF3 and PE3 (16.0kW and below) ranges only.

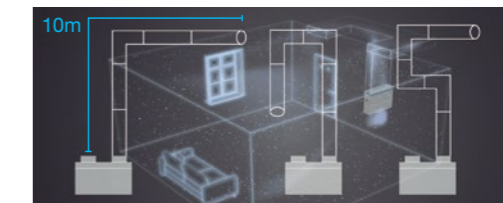

Based on in-house test result, even with a total ductwork length up to 10m, effectiveness of nanoe™ X is maintained.

Note: PF3 range only.

Indoor Unit Ultra Slim Ducted

With a height of only 200 mm, it provides greater flexibility and adaptability for various applications. In addition, high efficiency and extreme low noise level make it highly suitable for apartments and hotels.



CS-Z25UD3RAW
CS-Z35UD3RAW
CS-Z50UD3RAW
CS-Z60UD3RAW



Wired remote controller included.



CZ-TACG1*1

Note: Product image not to scale.

- 
Self-diagnosing Function
- 
Automatic Fan Operation
- 
Dry Mode
- 
Automatic Restart Function
- 
Built-in Drain Pump
- 
DC Motor

Technical focus

- Space saving 200mm height
- Easy maintenance and service by external electrical box
- Rear or Bottom Return Air Options
- 40 Pa static pressure enables ductwork to be fitted.
- Built-in Drain Pump
- DC fan motor greatly reduces power consumption

Ultra-slim profile for all models

200mm height for all models allows installation in very narrow ceilings.



Drain pump with increased power

Using the built-in high-lift drain pump, the drain piping rise height can be increased to 653 mm from the lower surface of the body.

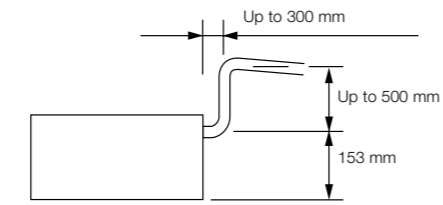

Specifications

Capacity		2.5KW	3.6KW	5.0KW	6.0KW
model Name	Indoor Unit	CS-Z25UD3RAW	CS-Z35UD3RAW	CS-Z50UD3RAW	CS-Z60UD3RAW
	Outdoor Unit	CU-Z25UBRA	CU-Z35UBRA	CU-Z50UBRA	CU-Z60UBRA
Cooling capacity :	kW	2.60 (0.85 - 3.20)	3.70 (0.85 - 4.00)	5.00 (0.90 - 5.70)	5.60 (0.90 - 6.50)
	Heating capacity	3.30 (0.85 - 4.90)	4.20 (0.85 - 5.60)	6.10 (0.90 - 7.20)	7.00 (0.90 - 8.00)
EER : COP	BTU/h	8,870 (2,900 - 10,900)	12,600 (2,900 - 13,600)	17,100 (3,070 - 19,400)	19,100 (3,070 - 22,200)
	W/W	11,300 (2,900 - 16,700)	14,300 (2,900 - 19,100)	20,800 (3,070 - 24,600)	23,900 (3,070 - 27,300)
Power input (min - max)	W/W	4.48 : 4.23	3.85 : 4.08	3.57 : 3.63	3.29 : 3.24
	Cooling : Heating kW	0.58 (0.24 - 0.85) : 0.78 (0.23 - 1.25)	0.96 (0.24 - 1.12) : 1.03 (0.23 - 1.57)	1.40 (0.26 - 1.78) : 1.68 (0.26 - 2.20)	1.70 (0.26 - 2.30) : 2.16 (0.26 - 2.60)
Indoor Unit					
Power source	Phase/Hz	1 Phase / 50Hz	1 Phase / 50Hz	1 Phase / 50Hz	1 Phase / 50Hz
	V	230V 240V	230V 240V	230V 240V	230V 240V
Dimensions	H x W x D mm	200 x 750 x 640	200 x 750 x 640	200 x 750 x 640	200 x 750 x 640
Net weight	kg	19	19	19	19
Air volume	Cooling : Heating L/s	175 : 175	187 : 187	255 : 255	262 : 262
	Sound pressure level (H/M/L) Cooling : Heating dB(A)	33 / 27 / 24 : 34 / 27 / 24	33 / 26 / 23 : 35 / 27 / 24	39 / 29 / 26 : 39 / 30 / 27	41 / 30 / 27 : 41 / 32 / 29
Sound power level (H/M/L) Cooling : Heating dB(A)		49 / 43 / 40 : 50 / 43 / 40	49 / 42 / 39 : 51 / 43 / 40	55 / 45 / 42 : 55 / 46 / 43	57 / 46 / 43 : 57 / 48 / 45
Outdoor Unit					
Power source	Phase/Hz	1 Phase / 50Hz	1 Phase / 50Hz	1 Phase / 50Hz	1 Phase / 50Hz
	V	230V 240V	230V 240V	230V 240V	230V 240V
Current (rated)	Cooling : Heating A	2.80 : 3.50 2.70 : 3.40	4.30 : 4.70 4.20 : 4.50	6.30 : 7.40 6.10 : 7.20	7.50 : 9.50 7.30 : 9.30
Dimensions	H x W x D mm	542 x 780 x 289	619 x 824 x 299	695 x 875 x 320	695 x 875 x 320
Net weight	kg	33	35	42	43
Piping connections	Liquid / Gas mm	Ø6.35 / Ø9.52	Ø6.35 / Ø9.52	Ø6.35 / Ø12.70	Ø6.35 / Ø12.70
Pipe length	min. - max. m	3 - 20	3 - 20	3 - 30	3 - 30
Elevation difference	m	15	15	20	20
Operation ranges	Cooling : Heating °C	-10 ~ +46 : -15 ~ +24	-10 ~ +46 : -15 ~ +24	-10 ~ +46 : -15 ~ +24	-10 ~ +46 : -15 ~ +24

Notes:

The Rated Capacity, Power Input and Running Current are measured in accordance with AS/NZS 3823

- Cooling: Indoor temperature: 27°C DB/ 19°C WB, Outdoor temperature: 35°C DB/ 24°C WB
- Heating: Indoor temperature: 20°C DB/ 15°C WB, Outdoor temperature: 7°C DB/ 6°C WB
- Indoor and outdoor sound levels are determined in an anechoic chamber and may differ once the unit is installed due to ambient conditions
- Sound levels are measured in default status which is rear return air, when changing to bottom return air, sounds levels may be higher.
- Ultra Slim Ducted is not supported by PAC Smart Connectivity+.

*1 If you connect WLAN adaptor (CZ-TACG1) to an indoor unit other than wall mounted type and operate from the smartphone with Panasonic Comfort Cloud App, airflow direction may not be operated as it is shown on the display.

Indoor Unit 4-WAY Cassette

Featuring uniform cooling, easy installation, and with a sleek exterior, this unit is the perfect match for all commercial applications.

nanoe™ X
Generator Mark1
nanoe™ X as a standard

- Self-diagnosing Function
- Automatic Fan Operation
- Dry Mode
- Intelligent Auto Swing
- Automatic Restart Function
- Auto Swing (Auto Flap Control)
- Built-in Drain Pump
- DC Motor



S-6071PU3E
S-1014PU3E



- 1 Air intake flange (ø100) (field supply).
 - 2 Air intake box CZ-ATU2*1 for Air intake plenum.
 - 3 Air intake plenum CZ-FDU3
- *1 When using Air intake box (CZ-ATU2), Air intake plenum (CZ-FDU3) required.

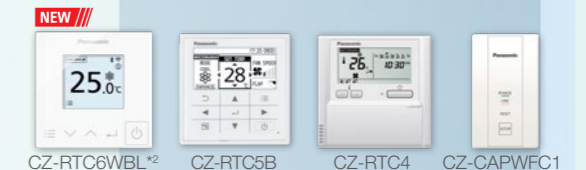

CZ-RTC6WBL*2 CZ-RTC5B CZ-RTC4 CZ-CAPWFC1
CZ-RTC6WBLW*2
*2 Launched in 4th Quarter in CY23. Black models are also available.
Note: Product image not to scale.

Technical focus

- Compact design
- Low sound levels
- DC fan motor for increased efficiency
- Powerful drain pump gives 850 mm lift
- Lightweight design
- Fresh air knockout
- Branch duct connection
- Optional air-intake plenum CZ-FDU3

360° Wide & Comfortable Airflow

Our design features wide-angle outlets and flaps that were designed through expert mechanics and prototype tests. Air from the centre is sent farther and the air blown out of the larger, side flaps spreads throughout the room. The air comes from all for sides of the unit and expands gently in a circle centred on the indoor unit.

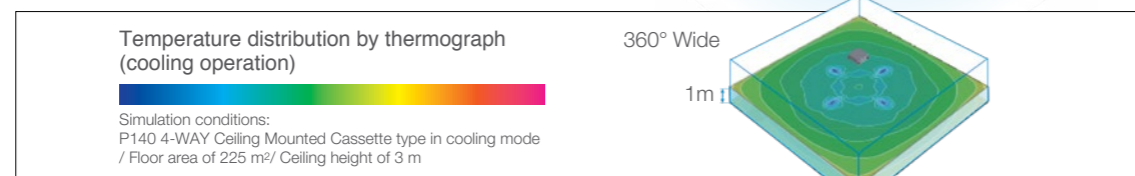
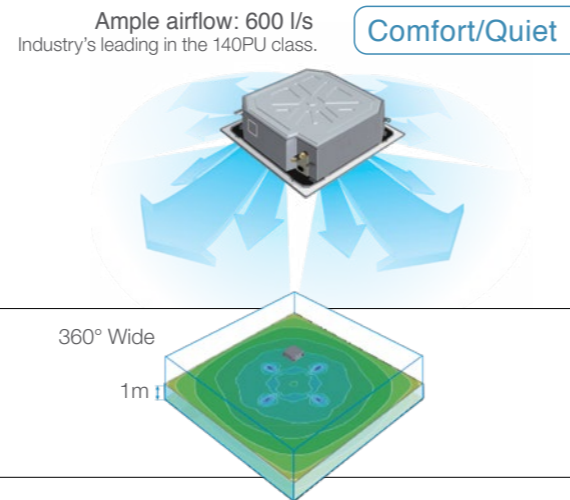

Wide Flap

Adding a sub flap and widening the main flap have reduced turbulence and increased airflow. Also, setting the jetting port at a wider angle allows the airflow to reach the corners of the room more quickly.

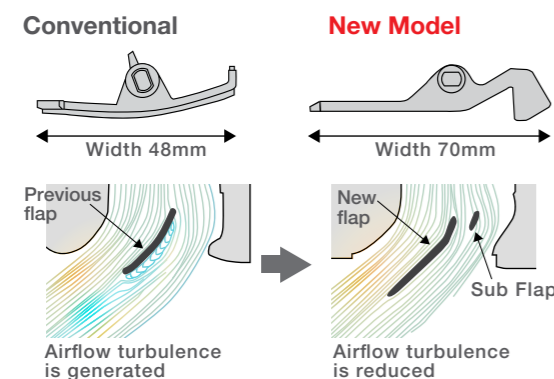

3D Turbo Fan

Using a twisted 3D blade made the unit slimmer and more compact, while also increasing the airflow. A 5-Speed mode allows the airflow to be adjusted in 5 steps to suit the situation.

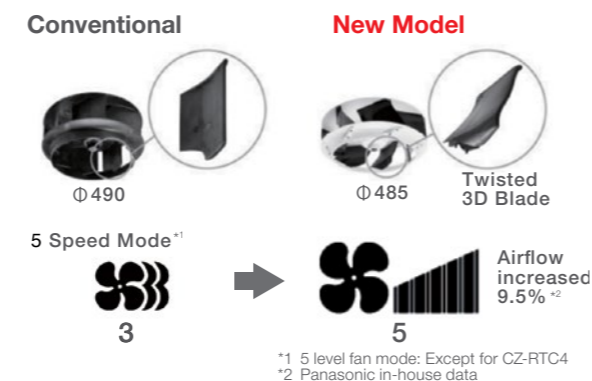

High-Ceiling Installation (Up to 5 m for 10.0kW+ models)

The units can be installed in rooms with high ceilings, where they provide ample floor-level heating in the winter. (See ceiling height guidelines below.)

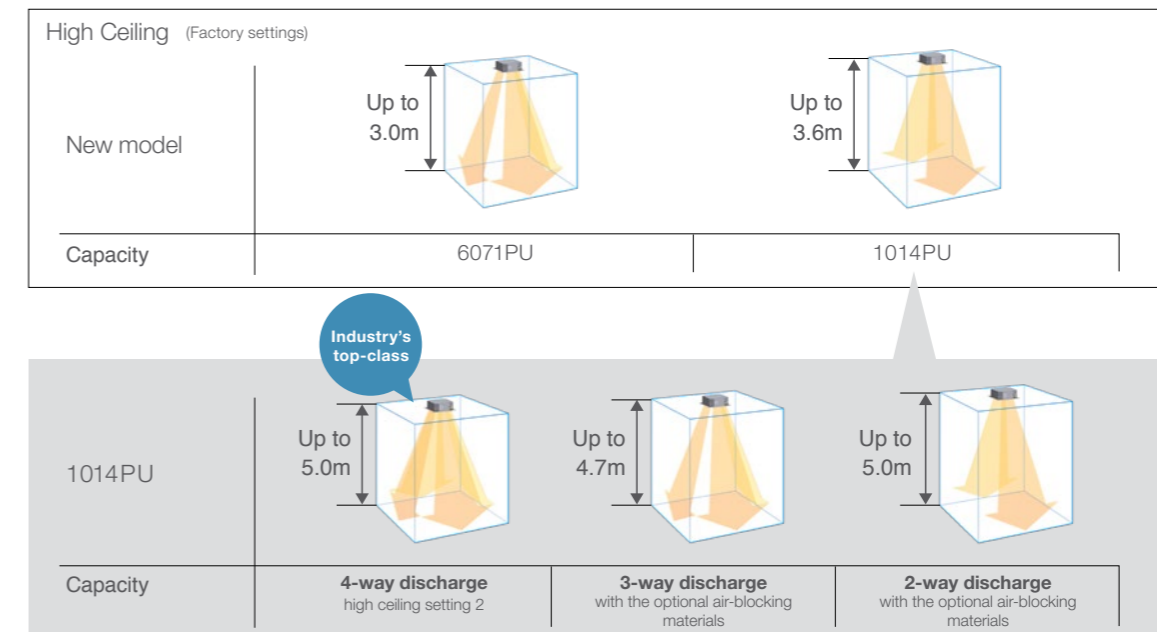

Ceiling height guidelines

Indoor unit	*3 settings 4-way discharge			3-way discharge (optional air-blocking materials)	2-way discharge (optional air-blocking materials) *4
	Standard (Factory setting)	High ceiling setting 1	High ceiling setting 2		
6071PU	3.0	3.3	3.6	3.8	4.2
1014PU	3.6	4.3	5.0	4.7	5.0

*3 When using the unit in a configuration other than the factory settings, it is necessary to make settings on site to increase airflow.
*4 Use air-blocking materials (CZ-CFU3) to completely block two discharge outlets for 2-way airflow.

Indoor Unit Low Profile Mini Cassette

Redesigned for a lower vertical profile, it fits easily into a standard 60 x 60cm ceiling grid without the need to alter bar configuration. This makes the Low Profile Mini Cassette ideal for small commercial and retrofit applications, in particular those with lower ceilings.

nanoe™ X
Generator Mark2
nanoe™ X as a standard

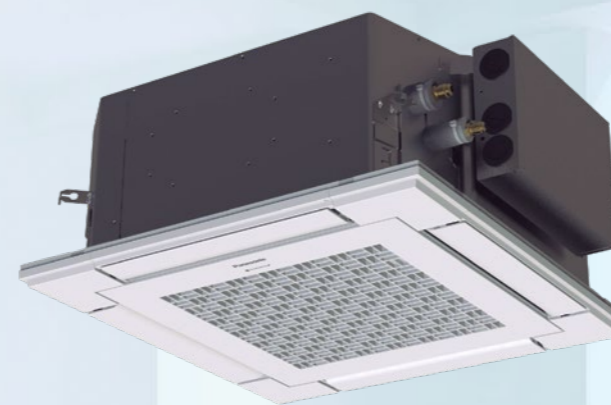

S-25PY3E
S-36PY3E
S-50PY3E
S-60PY3E



Panel CZ-KPY4



CZ-RTC6WBL*1 CZ-RTC5B CZ-RTC4 CZ-CAPWFC1

CZ-RTC6WBLW*1

*1 Launched in 4th Quarter in CY23. Black models are also available. Note: Product image not to scale.

Technical focus

- Market-leading energy efficiency
- Compact design (230mm High)
- Easy installation
- Built-in drain pump
- Mini cassette fits into a 600 x 600mm ceiling grid
- Powerful drain pump gives 850mm lift
- DC fan motor with variable speed and a new heat exchanger ensures efficient power consumption
- Multi-directional air flow

Compact, stylish design

Thanks to advanced Panasonic design the panel is a compact 625 x 625mm, offering elegant, unobtrusive installation even where space is limited.

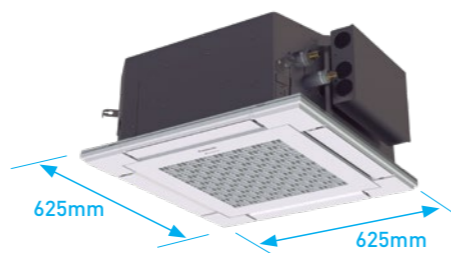

Lighter and slimmer for easier installation

When only 230mm of indoor body height, it can easily fit in limited spaces and tight spots. (Required 243mm from bottom of panel to top of the unit)

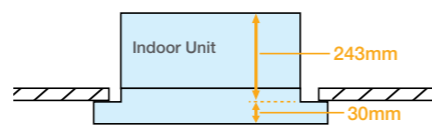

Individual flap control

Keep everyone comfortable by directing air where it's needed and away from where it isn't with individual flap control.

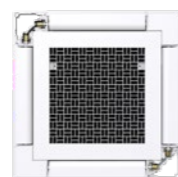

A drain height of up to 850mm from the ceiling surface

The internal pump allows the drain pipe to be elevated up to 850mm above the base of the unit.

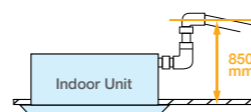

Specifications

Capacity		2.5KW	3.5KW	5.0KW	6.0KW	
model Name	Indoor Unit	S-25PY3E	S-36PY3E	S-50PY3E	S-60PY3E	
	Outdoor Unit	U-25PZ3R5	U-36PZ3R5	U-50PZ3R5	U-60PZ3R5	
	Panel	CZ-KPY4	CZ-KPY4	CZ-KPY4	CZ-KPY4	
	Receiver	CZ-RWRY3	CZ-RWRY3	CZ-RWRY3	CZ-RWRY3	
Cooling capacity :	kW	2.5 (1.3-3.9)	3.6 (1.5-4.0)	5.0 (1.5-6.4)	6.0 (2.0-7.0)	
	Heating capacity	3.2 (1.3-4.6)	3.6 (1.3-4.6)	5.0 (1.5-6.4)	6.0 (1.8-7.0)	
BTU/h		8,500 (4,400-13,300)	12,300 (5,100-13,600)	17,100 (5,100-21,800)	20,500 (6,800-23,900)	
		10,900 (4,400-15,700)	12,300 (4,400-15,700)	17,100 (5,100-21,800)	20,500 (6,100-23,900)	
EER : COP	W/W	4.46 : 4.44	4.55 : 4.29	3.50 : 3.94	3.39 : 3.61	
Power input (min - max)	Cooling : Heating	kW	0.56(0.27-1.10):0.72(0.25-1.35)	0.91(0.28-1.12):0.84(0.25-1.36)	1.43(0.27-2.20):1.27(0.27-2.20)	1.77(0.34-2.53):1.66(0.39-2.45)
Indoor Unit						
Power source	Phase/Hz	1 Phase/ 50Hz	1 Phase/ 50Hz	1 Phase/ 50Hz	1 Phase/ 50Hz	
	V	230V 240V	230V 240V	230V 240V	230V 240V	
Current	Cooling, Heating A	2.55, 3.25 2.45, 3.10	4.05, 3.75 3.85, 3.60	6.35, 5.70 6.10, 5.45	8.10, 7.35 7.75, 7.05	
Dimensions	H x W x D	mm	243 x 575 x 575	243 x 575 x 575	243 x 575 x 575	
Net weight		kg	15	15	15	
Air volume	Cooling : Heating	L/s	141 : 141	158 : 158	200 : 200	
Sound pressure level (H/M/L)	Cooling : Heating	dB(A)	31/28/25 : 31/28/25	34/30/25 : 34/30/25	39/34/27 : 39/34/27	43/37/31 : 43/37/31
Sound power level (H/M/L)	Cooling : Heating	dB(A)	46/43/40 : 46/43/40	49/45/40 : 49/45/40	54/49/42 : 54/49/42	58/52/46 : 58/52/46
Outdoor Unit						
Power source	Phase/Hz	1 Phase / 50Hz	1 Phase / 50Hz	1 Phase / 50Hz	1 Phase / 50Hz	
	V	230V 240V	230V 240V	230V 240V	230V 240V	
Dimensions	H x W x D	mm	619 x 824 x 299	619 x 824 x 299	619 x 824 x 299	
Net weight		kg	31	31	35	
Piping connections	Liquid / Gas	mm	Ø6.35 / Ø12.7	Ø6.35 / Ø12.7	Ø6.35 / Ø12.7	
Pipe length	min. - max.	m	3 - 20	3 - 20	3 - 30	
Elevation difference		m	15	15	30	
Operation ranges	Cooling : Heating	°C	-10 - +46 : -15 - +24	-10 - +46 : -15 - +24	-10 - +46 : -15 - +24	

Notes:
The Rated Capacity, Power Input and Running Current are measured in accordance with AS/NZS 3823
• Cooling: Indoor temperature: 27°C DB/ 19°C WB, Outdoor temperature: 35°C DB/ 24°C WB
• Heating: Indoor temperature: 20°C DB/ 15°C WB, Outdoor temperature: 7°C DB/ 6°C WB

Indoor Unit Under Ceiling

Providing outstanding energy-saving performance, comfort and long-distance airflow distribution, these units are perfect for retail stores and schools.

nanoe™ X
Generator Mark2
nanoe™ X as a standard



S-6071PT3E



S-1014PT3E



CZ-RTC6WBL*1 CZ-RTC6WBLW *1 CZ-RTC5B CZ-RTC4 CZ-CAPWFC1

*1 Launched in 4th Quarter in CY23. Black models are also available. Note: Product image not to scale.

- Self-diagnosing Function
- Automatic Fan Operation
- Automatic Restart Function
- DC Motor

Compact Looking, Stylish, One-motion Design

With its streamlined, one-motion form, the unit looks thin and compact when installed for a neat appearance in any room. When not operating, the louver closes to provide an elegant look while also keeping the unit clean.



Comfortable, Long-Distance Airflow Distribution

The shape of the outlet has been optimised to provide long-distance air flow distribution. Even in long rooms, air flow reaches every corner for exceptionally comfortable air conditioning.

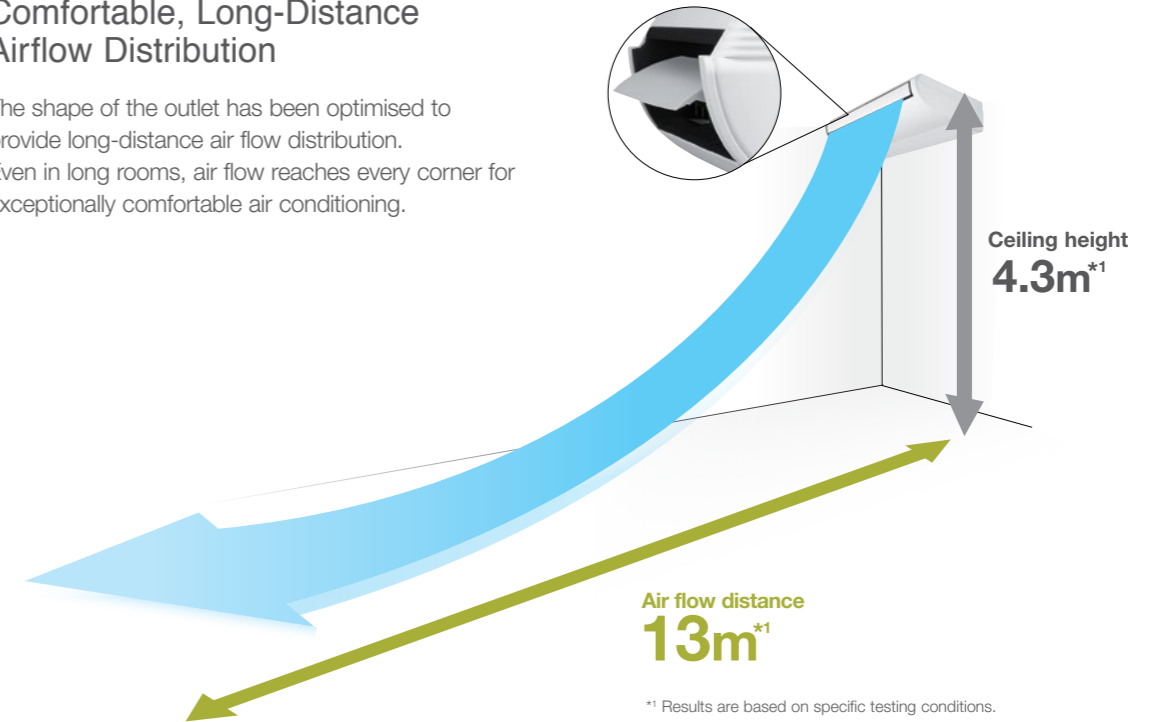

Air flow distance
13m*1

Ceiling height
4.3m*1

*1 Results are based on specific testing conditions.

Energy-saving Technology Delivering Top-class Efficiency

Optimisation of the shape of the casing and fan assures bigger air flow and higher efficiency. Energy-saving performance is top class in the industry.

Top Class Energy Saving

New DC fan motor



Large Diagonal Air Flow Fan

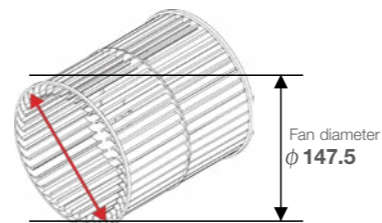

High Ceiling Setting*2	Air flow distance		
	100	125	140
4.3m	Up to 12m	Up to 13m	Up to 13m

*2 Dedicated fan speed setting required.



Wall Mounted

Providing small, lightweight and low noise level design, it is ideal for small offices and other commercial applications. It also has a stylish smooth design with a washable front panel.

nanoe™ X
Generator Mark2
 nanoe™ X as a standard

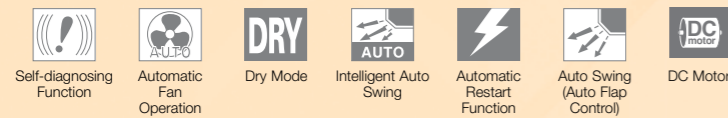

*1 Launched in 4th Quarter in CY23. Black models are also available. Note: Product image not to scale.

Technical focus

- Closed discharge port when not in use
- Lighter and smaller units make installation easy
- Quiet operation
- Smooth and durable design
- Piping outlet in six directions
- Washable front panel
- Air distribution is automatically altered depending on the operational mode of the unit

Closed discharge port

When the unit is turned off, the flap closes completely to prevent entry of dust into the unit and to keep the equipment clean.

Quiet operation

Low operating noise level makes these units ideal for hotels and hospital applications.

Piping outlet in six directions

Piping outlet is possible in the six directions of right, right rear, right bottom, left, left rear, left bottom, making installation easier.

Washable front panel

The indoor unit's front panel can be easily cleaned for trouble-free maintenance.



Air distribution is automatically adjusted depending on the operational mode of the unit

Air outlet angle is automatically adjusted for cooling and heating operation.

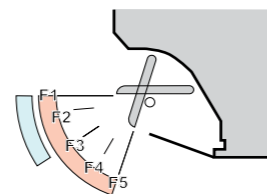

Heating: F1 to F5
 Cooling: F1 to F3

Specifications R32 REFRIGERANT

Capacity		9.5kW		9.0kW		
Model Name	Indoor Unit / Outdoor Unit	S-100PK3R / U-100PZH3R5	S-100PK3R / U-100PZH3R8	S-100PK3R / U-100PZ3R5	S-100PK3R / U-100PZ3R8	
Cooling capacity :	kW	9.5 (3.1 - 10.5)	9.5 (3.1 - 10.5)	9.0 (3.0 - 9.7)	9.0 (3.0 - 9.7)	
		9.5 (3.1 - 11.5)	9.5 (3.1 - 11.5)	9.0 (3.0 - 10.5)	9.0 (3.0 - 10.5)	
Heating capacity	BTU/h	32,400 (10,600 - 35,800)	32,400 (10,600 - 35,800)	30,700 (10,200 - 33,100)	30,700 (10,200 - 33,100)	
		32,400 (10,600 - 39,200)	32,400 (10,600 - 39,200)	30,700 (10,200 - 35,800)	30,700 (10,200 - 35,800)	
EER : COP	W/W	3.26 : 3.97	3.26 : 3.97	3.47 : 3.93	3.47 : 3.93	
COP@H2 condition	W/W	2.50	2.50	2.53	2.53	
Total power input	Cooling : Heating kW	2.91 : 2.39 / 5.07 : 5.70	2.91 : 2.39 / 5.07 : 5.70	2.59 : 2.29 / 4.85 : 5.29	2.59 : 2.29 / 4.85 : 5.29	
TCSPF : HSPF	Residential	Average Climate	4.52 : 4.74	4.52 : 4.74	4.21 : 4.55	4.21 : 4.55
		Cold Climate	4.72 : 4.10	4.72 : 4.10	4.27 : 3.99	4.27 : 3.99
	Commercial	Hot Climate	5.68 : 5.77	5.68 : 5.77	5.39 : 5.31	5.39 : 5.31
		Average Climate	5.85 : 5.20	5.85 : 5.20	5.42 : 4.87	5.42 : 4.87
	Cold Climate	6.42 : 4.59	6.42 : 4.59	5.82 : 4.37	5.82 : 4.37	
Indoor Unit						
Power source	Phase/Hz V	1 Phase / 50Hz 230V 240V	1 Phase / 50Hz 230V 240V	1 Phase / 50Hz 230V 240V	1 Phase / 50Hz 230V 240V	
Dimensions	H x W x D Indoor	mm 302 x 1,120 x 236	mm 302 x 1,120 x 236	mm 302 x 1,120 x 236	mm 302 x 1,120 x 236	
Net weight		kg 14	kg 14	kg 14	kg 14	
Air volume (H/M/L)	Cooling : Heating L/s	367 / 308 / 250 / 367 / 308 / 250	367 / 308 / 250 / 367 / 308 / 250	367 / 308 / 250 / 367 / 308 / 250	367 / 308 / 250 / 367 / 308 / 250	
Sound pressure level (H/M/L)	Cooling : Heating dB(A)	49 / 45 / 41 : 49 / 45 / 41	49 / 45 / 41 : 49 / 45 / 41	49 / 45 / 41 : 49 / 45 / 41	49 / 45 / 41 : 49 / 45 / 41	
Sound power level (H/M/L)	Cooling : Heating dB	65 / 61 / 57 : 65 / 61 / 57	65 / 61 / 57 : 65 / 61 / 57	65 / 61 / 57 : 65 / 61 / 57	65 / 61 / 57 : 65 / 61 / 57	
Number of fan speeds		5	5	5	5	
Drain pipe size	mm	VP-16	VP-16	VP-16	VP-16	
Outdoor Unit						
Power source	Phase/Hz V	1 Phase / 50Hz 230V 240V	3 Phase / 50Hz 400V 415V	1 Phase / 50Hz 230V 240V	3 Phase / 50Hz 400V 415V	
Current (rated)	Cooling : Heating A	13.8 : 11.3 13.2 : 10.8	4.60 : 3.80 4.40 : 3.60	12.4 : 10.9 11.9 : 10.5	4.10 : 3.65 3.95 : 3.50	
Dimensions	H x W x D	mm 1,416 x 940 x 340	mm 1,416 x 940 x 340	mm 996 x 980 x 370	mm 996 x 980 x 370	
Net weight		kg 99	kg 99	kg 83	kg 83	
Air volume	Cooling : Heating m³/min	1,970 : 1,803	1,970 : 1,803	1,219 : 1,219	1,219 : 1,219	
Sound pressure level (Silent mode)	Cooling : Heating dB(A)	52 (50) : 52 (50)	52 (50) : 52 (50)	52 (50) : 52 (50)	52 (50) : 52 (50)	
Sound power level (Silent mode)	Cooling : Heating dB	68 (66) : 68 (66)	68 (66) : 68 (66)	70 (68) : 70 (68)	70 (68) : 70 (68)	
Piping connections	Liquid / Gas mm	Ø9.52 / Ø15.88	Ø9.52 / Ø15.88	Ø9.52 / Ø15.88	Ø9.52 / Ø15.88	
Pipe length range	min. - max. m	5 - 85	5 - 85	5 - 50	5 - 50	
Elevation difference (OU located lower, OU located higher)	m	15, 30	15, 30	15, 30	15, 30	
Maximum chargeless length	m	30	30	30	30	
Refrigerant at shipping, Additional gas amount	g	R32 3,050 / 45 (g/m)	R32 3,050 / 45 (g/m)	R32 2,400 / 45 (g/m)	R32 2,400 / 45 (g/m)	
Operating range	Cooling : Heating °C	-15 to 48 : -20 to 24	-15 to 48 : -20 to 24	-10 to 46 : -15 to 24	-10 to 46 : -15 to 24	

- Notes:
- In the case of nanoe X OFF
 - In case it is necessary to indicate the air flow volume in (l/s), the value in (m³/min.) shall be multiplied by 16.7 and rounded down the decimal point.
 - AEER and ACOP classification is at 230V(400V) only in accordance with GEMS2019.
 - TCSPF, HSPF and Total Energy consumption indicate the value of average temperature zone.
 - Indoor and outdoor sound levels are determined in an anechoic chamber and may differ once the unit is installed due to ambient conditions
 - H:High at setting 5 stage (Level 5), M:Middle at setting 5 stage (Level 3), L:Low at setting 5 stage (Level 1)

Floor Console

This floor-type console's slender profile integrates unobtrusively into any interior, in a position that's also ideal when you want to warm your feet when it's cold.

nanoe™ X
Generator Mark1
 nanoe™ X as a standard



CS-Z25UFRAW
 CS-Z35UFRAW
 CS-Z50UFRAW



Wireless remote controller included.



CZ-TACG1*1

Note: Product image not to scale.

-  Self-diagnosing Function
-  Automatic Fan Operation
-  DRY Mode
-  Automatic Restart Function
-  Auto Swing (Auto Flap Control)
-  DC Motor

Technical focus

- A breakthrough design that integrates perfectly with the most modern environments.
- Compact design fits 50mm wall recess

Upper & Lower Vane Blow

Optimum air flow from the top and bottom of the unit assures that even your feet are kept comfortably warm. (Only during heating)

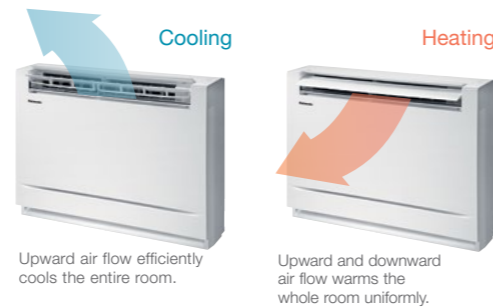

Compact Design

The design features a flat, elegant front panel that provides a neat appearance and the unit can be recessed into a wall up to 50mm.



Super Quiet

The indoor and outdoor units deliver quiet operation and pressing the Quiet mode button lowers operation noise even further to just 19dB for indoor unit with low fan speed.

19dB*1
 Indoor



*1 CS-Z25UFRAW & CS-Z35UFRAW: In the Quiet mode during heating operation with low fan speed.

Specifications of Current Model



Capacity		2.5kW	3.5kW	5.0kW	
Model Name	Indoor Unit	CS-Z25UFRAW	CS-Z35UFRAW	CS-Z50UFRAW	
	Outdoor Unit	CU-Z25UBRA	CU-Z35UBRA	CU-Z50UBRA	
Cooling capacity : Heating capacity	kW	2.50 (0.85~3.40) 3.40 (0.85~5.00)	3.50 (0.85~3.80) 4.30 (0.85~6.00)	5.00 (0.90~5.70) 5.60 (0.90~8.10)	
	BTU/h	8,530 (2,900~11,600) 11,600 (2,900~17,100)	11,900 (2,900~13,000) 14,700 (2,900~20,500)	17,100 (3,070~19,400) 19,100 (3,070~27,600)	
EER : COP	W/W	5.00 : 4.59	4.07 : 4.06	3.65 : 3.81	
Power input (min-max)	Cooling : Heating kW	0.50 (0.24-0.90) 0.74 (0.24-1.35)	0.86 (0.24-1.02) 1.06 (0.24-1.75)	1.37(0.26-1.81) : 1.47 (0.26-2.60)	
	Residential	Hot Climate Average Climate Cold Climate	5.70 : 4.12 5.05 : 4.21 4.97 : 3.94	5.46 : 4.49 5.01 : 4.29 5.07 : 3.78	5.51 : 4.48 5.20 : 4.18 5.37 : 3.69
TCSPF : HSPF	Commercial	Hot Climate Average Climate Cold Climate	6.22 : 3.89 6.40 : 3.85 6.97 : 3.78	6.01 : 4.18 6.80 : 4.00 7.31 : 3.80	6.16 : 4.20 7.34 : 3.99 8.46 : 3.76
	Indoor Unit		Phase/Hz V	1 Phase / 50Hz 230V 240V	1 Phase / 50Hz 230V 240V
Power source	Phase/Hz V	1 Phase / 50Hz 230V 240V	1 Phase / 50Hz 230V 240V	1 Phase / 50Hz 230V 240V	
Dimensions	H x W x D	600 x 750 x 207	600 x 750 x 207	600 x 750 x 207	
Net weight	kg	13	13	13	
Air volume	Cooling : Heating L/s	163 : 173	170 : 182	198 : 227	
Sound pressure level (H/M/L)	Cooling : Heating dB(A)	38 / 25 / 20 : 38 / 25 / 19	39 / 26 / 20 : 39 / 25 / 19	44 / 31 / 27 : 46 / 33 / 29	
Sound power level (H/M/L)	Cooling : Heating dB(A)	54 / 41 / 36 : 54 / 41 / 35	55 / 42 / 36 : 55 / 41 / 35	60 / 47 / 43 : 62 / 49 / 45	
Outdoor Unit		Phase/Hz V	1 Phase / 50Hz 230V 240V	1 Phase / 50Hz 230V 240V	
Power source	Phase/Hz V	1 Phase / 50Hz 230V 240V	1 Phase / 50Hz 230V 240V	1 Phase / 50Hz 230V 240V	
Current (rated)	Cooling : Heating A	2.40 : 3.40 2.30 : 3.25	3.90 : 4.80 3.70 : 4.60	6.20 : 6.60 6.00 : 6.40	
Dimensions	H x W x D	542 x 780 x 289	619 x 824 x 299	695 x 875 x 320	
Net weight	kg	33	35	42	
Piping connections	Liquid / Gas	Ø6.35 / Ø9.52	Ø6.35 / Ø9.52	Ø6.35 / Ø9.52	
Pipe length	min. - max.	3 - 20	3 - 20	3 - 30	
Elevation difference	m	15	15	20	
Piping connections	Cooling : Heating °C	-10 to 46 : -15 to 24	-10 to 46 : -15 to 24	-10 to 46 : -15 to 24	

Notes:

The Rated Capacity, Power Input and Running Current are measured in accordance with AS/NZS 3823

- Cooling: Indoor temperature: 27°C DB/ 19°C WB, Outdoor temperature: 35°C DB/ 24°C WB
- Heating: Indoor temperature: 20°C DB/ 15°C WB, Outdoor temperature: 7°C DB/ 6°C WB
- Indoor and outdoor sound levels are determined in an anechoic chamber and may differ once the unit is installed due to ambient conditions.
- Floor console is not supported by PAC Smart Connectivity+.

*1 If you connect WLAN adaptor (CZ-TACG1) to an indoor unit other than wall mounted type and operate from the smartphone with Panasonic Comfort Cloud App, airflow direction may not be operated as it is shown on the display.

Smart Connectivity and Control Solutions

Panasonic offers a range of smart connectivity and control solutions for residential and commercial applications that allow you to conveniently manage and monitor air conditioning units in single or multiple locations from one mobile device. Add solutions for partners such as contractors and service providers that simplify everything from configuration to repair diagnosis and discover a streamlined, next-generation air conditioning ecosystem.



For Residential

Panasonic Comfort Cloud Home Automation Ready

Personal Control Solutions Panasonic Comfort Cloud

- Remotely manage and monitor multiple air conditioning units in your home**
Easily control and access all features of the air conditioning units with smart centralised control.
- Intuitive voice control**
Control air conditioning units by voice command connecting to smart speaker.



PLUG & PLAY FOR HOME AUTOMATION

Easily connect with integrated controllers to become part of your automated home network.



Note: For further information, please check CLIPSAL® website.

by Schneider Electric

For Light Commercial

Panasonic Comfort Cloud **PAC Smart Connectivity+**

Cost Effective Energy Management Solution



- Multiple location control at your convenience with Comfort Cloud**
Gain control of multiple zones and sites intuitively adjusting temperature by areas with differentiated user rights settings.
- Indoor Air Quality (IAQ) and efficient energy usage with PAC Smart Connectivity+**
 - Ultimate cooling comfort with sensing technology and automatic IAQ control.
 - Simplified Plug & Play installation with BMS connection for better energy consumption.

Wide Range of Smart Control Solutions for All Needs

Whether you're a contractor or service provider looking for solutions to streamline everything from configuration to repair diagnosis, a facility manager overseeing multiple sites or a single office, or you're simply managing a home system, we offer a range of innovative, next-generation smart control solutions to suit your needs.

For end users and facility managers			For contractors/service providers	
<p>Panasonic Comfort Cloud</p> <p>Intuitive and scalable air conditioning control solution using a personal mobile device.</p>	<p>PAC Smart Connectivity+</p> <p>Offers efficient energy management with high indoor air quality (IAQ) control.</p>	<p>Panasonic AC Smart Cloud</p> <p>Monitor and manage energy consumption of multiple location through a cloud computing system.</p>	<p>H&C Diagnosis APP H&C Control APP</p> <p>Connect to APP via Bluetooth for greatly improved convenience during configuration and repair diagnosis.</p>	

For Multiple Building Management

Panasonic AC Smart Cloud

Full Control of All Installations From A Single Internet Connection Panasonic AC Smart Cloud

- Manage and monitor energy consumption patterns**
Analyse energy usage, running time and optimise temperatures to reduce energy costs.
- Centralised control solution with zero downtime**
Receive real-time status updates to prevent breakdowns.
- Flexible and scalable solution for expanding businesses and multi sites**
Adaptable solutions that can easily be upgraded for new features, meet user demand and better IT management.

*1 CZ-TACG1 or CZ-CAPWFC1 Network Adaptor required per unit. Requires an Internet connection and the App downloaded from the App Store or GooglePlay Store on your smartphone or tablet with the latest Operating System available. To use Google Assistant to control your air conditioner, you will need a Google Assistant device. Google is a trademark of Google LLC. Google Home is compatible with the air conditioning systems shown on pages 4 and 5. Google functionality is only available with complete air conditioning systems (including Panasonic controllers).

Panasonic Comfort Cloud

Control air conditioning units from wherever and whenever with your smartphone, by using Panasonic Comfort Cloud and WLAN smart adaptor. This scalable solution is ideal for one system, one site or multiple locations. Coupling the adapter with the already feature rich systems, makes it an ideal solution for both residential and commercial applications.



For Residential
Remotely manage and monitor air conditioning units from anywhere anytime.

For Light Commercial
Gain control of multiple zones and sites intuitively up to 200 indoor units.

Panasonic Comfort Cloud features

Voice Control

Control air conditioning units by voice command intuitively connecting to smart speaker.*1



From 1 to 200 Units

User can control up to 200 indoor units. 10 different sites, with up to 20 units / groups per site.



Easy Scheduling

Complex weekly scheduling made simple. Not only for one units, but across multiple sites and from a smartphone.

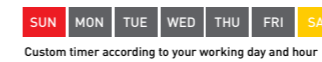

Multiple User

The Panasonic Comfort Cloud App allows multiuser access control. Restrict user access to specific units.



Energy Monitor

See the estimated power consumption and compare with other periods to see how energy bill can be reduced even more.*2

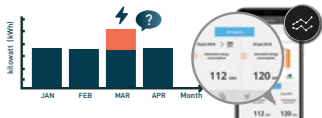

Error Codes

Error code notification through the App, provides early notification and allows for faster repair.



Application Examples

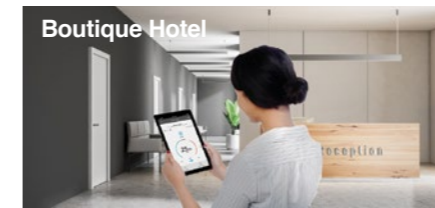

Centralised control from reception.

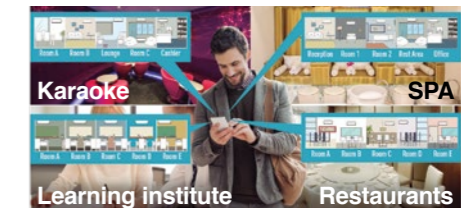

Multiple location control for small business.

System Configuration

Network Adaptor

CZ-TACG1 CZ-CAPWFC1



Connection Diagram



Indoor Unit

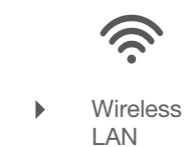

In conformity with IEEE 802.11

CZ-TACG1: For products for small sized project.
CZ-CAPWFC1: Available for all types of VRF and PAC indoor unit.

WLAN Smart Adaptor Specification

	CZ-TACG1	CZ-CAPWFC1
Input Voltage	DC 12V (Supplied from indoor unit)	
Power Consumption	Maximum 0.66W	Maximum 2.4W
Size [H x W x D]	66 x 36 x 12mm	120 x 70 x 25mm
Weight	Approx. 85g	190g (including communications lines)
Interface	Wireless LAN	
Wireless LAN Standard	IEEE 802.11 b/g/n	
Frequency range	2.4GHz band	
Encryption	WPA2-PSK(TKIP/AES)	
Operation range	0-55°C, 20 - 80RH%	

*1 CZ-TACG1 or CZ-CAPWFC1 Network Adaptor required per unit. Requires an internet connection and the App downloaded from the App Store or GooglePlay Store on your smartphone or tablet with the latest Operating System available. To use Google Assistant to control your air conditioner, you will need a Google Assistant device. Google is a trademark of Google LLC. Google Home is compatible with the air conditioning systems shown on pages 4 and 5. Google functionality is only available with complete air conditioning systems (including Panasonic controllers).
*2 Function available depending on the model.



Comfort Cloud App



Compatible Device and Browsers

1. IOS 9.0 or above
2. Android 5.0 or above

Plug & Play for Home Automation

Easily connect with integrated controllers to become part of your automated home network. Plug & Play with Clipsal solutions to enjoy simplicity you've been waiting for, empowering you to take control of your home's technology.



Easy Design / Plug & Play

Clipsal control solution brings you smart home technologies and enables you to control devices at your fingertips from any smart phone or tablet. Panasonic air conditioners are ready for this smart home automation with just plug-and-play connectivity.

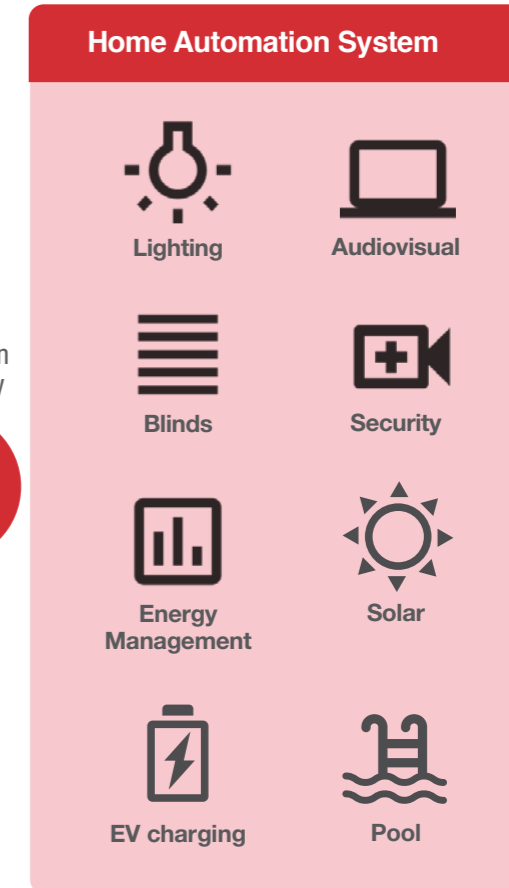

Applies to selected Panasonic Air Conditioning systems only, please consult with Panasonic for more details.

Case Study

Panasonic VRF system was selected for the smart apartments, Lilydale Grove, which integrates robust automation technology to simplify your life. While other air conditioner brands need an adaptor to connect to HEMS, Panasonic can seamlessly connect with Schneider's Home automation, one of the market leaders in the HEMS industry.



- Air conditioning system FSV Heat Recovery (20 systems)
FSV Heat Pump (4 systems)
- Cooling Capacity 742kW
- Indoor units 278 units
- Control System SER8150 x 278units

Note: System combination as of July 2020



Panasonic partnering with Schneider Electric offering home automation solution with CLIPSAL interfaces and devices.



Note: For further information please check CLIPSAL® website.

PAC Smart Connectivity+

Through thorough energy management, Panasonic's PAC Smart Connectivity+*1 is a completely new, state-of-the-art solution providing energy saving and comfort as well as simple installation, operation and maintenance.



PAC Smart Connectivity+ ~New SE8000 series~

1. Quality Air Control

Optimum IAQ is realized using the CO2 & humidity sensors. The interior remains comfortable, while heating and cooling costs are minimized.

The CO2 sensor controls ventilation systems which contributes to improving the room's air quality.



2. Room Key Card or Key Cardless Solutions for Hotels

Solutions are provided that meet the needs of various regions and hotel grades.

Whilst the previous model's automatic detection function offered optimal air conditioning with or without a hotel room key card, the latest model enables conventional key cards to control air conditioners and other devices coordinately. The increase in the types of devices that can be connected enables customized control of any hotel room.

3. Other Equipment Control

One room controller manages various devices including lighting and the blinds. A ventilation system and other external connection devices can be connected by using HRC*2 or SE8350 so that various control is possible with this controller alone, even without BMS.



PAC Smart Connectivity+

PAC Smart Connectivity+ offers efficient energy management and a new air conditioning control solution with high IAQ (Indoor Air Quality).

Energy Management System for Rooms

Each room is monitored by high-precision sensors, making it possible to make every room's temperature comfortable without wasting energy.

Management System for the Entire Building

A Building Energy Management System (BMS) can also be connected for Plug & Play centralised control of the building's entire energy consumption.

Advantages



Dramatic Reduction of OpEx with Outstanding IAQ.

- 3 Built-in sensors: Temperature, RH and Occupancy
- ZigBee wireless sensors: CO2/Temperature/RH%, window/door, ceiling/wall



Ultimate Customisation.

- Background colour customisable
- Custom display/icons, messages
- Programmable logic (also standalone)
- Various controls and various external connection devices



User-/Owner-friendly.

- Colour touch screen
- Ease and simply of use
- 22 Languages
- Easy-to-understand error description



Easy Design and Plug and Play to Reduce CapEx.

- Simple Plug & Play connection to Building Energy Management System (BMS)
- Stand alone or BMS connected
- Easy Installation of Zigbee Sensors

*1 Not compatible with Ultra Slim Ducted, 4-Way Mini Cassette and Floor Console systems.

*2 Available through a Schneider Electric distribution channel.

Energy Management System for Rooms

By installing a ceiling motion sensor, wall motion temperature sensor, window/door sensor, and CO₂ sensor in the room, ideal, waste-free air conditioning is achieved.

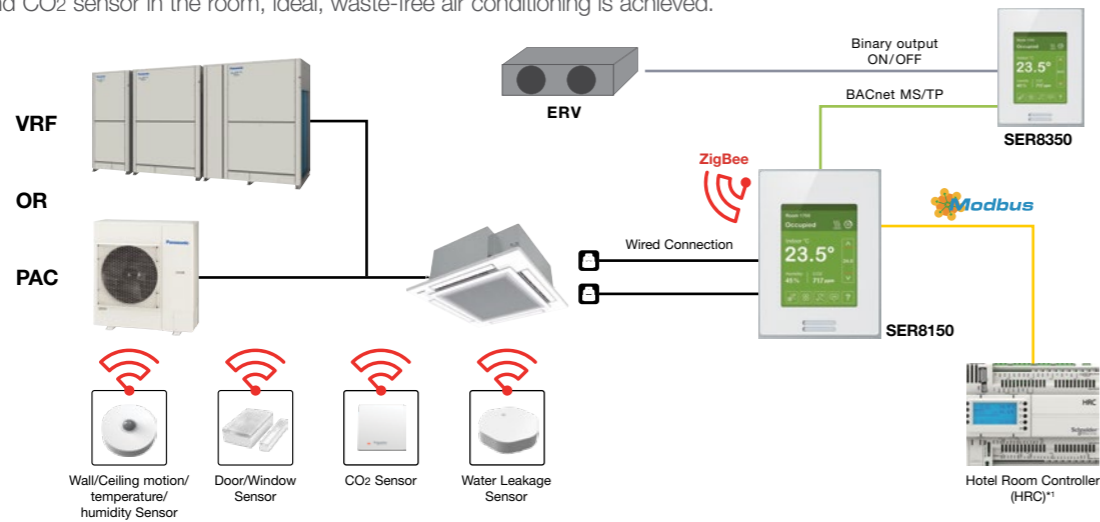





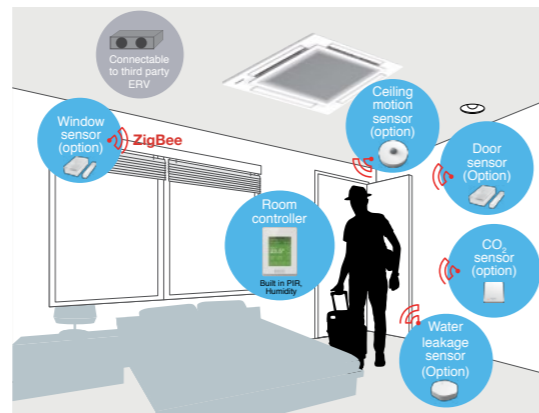

Sensing & Control technology

Using sensors from Schneider Electric, high-quality occupancy control and automatic IAQ control were realised. The sensors detect the presence or absence of occupants, and the opening and closing of doors and windows to achieve the most efficient energy management for exceptional air-conditioned comfort. Flexible installation is possible to match different applications and building features such as walls, ceilings and proximity to doors and windows. No wiring means extra installation versatility.

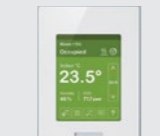

Batteries last for up to five years (10-year battery for CO₂ sensor) and are easy to install and replace.

 <p>Door/Window Sensor Door and window contact detection sensor to monitor opening and closing.</p>	 <p>Wall/Ceiling motion/temperature/humidity Sensor Wall and ceiling sensor to detect the presence or absence of occupants.</p>	 <p>CO₂ Sensor Monitor indoor air quality, review data on interfacing devices, and control fresh air inside customizable zones.</p>
 <p>Water Leakage Sensor Two sensing pads under the body activate when water is present between the two pads. Detecting the water, the sensor reports the event to the controller.</p>	 <p>SER8350 Programmable controller for HVAC equipment. Includes local memory to store control sequence.</p>	 <p>Hotel Room Controller (HRC)*1 The Hotel Room Controller controls connected guest room devices and aggregates data, making it visible to guest room and property management systems.</p>

*1 Available through a Schneider Electric distribution channel.

Management System for the Entire Building*2

The smarter solution to simplify energy management, optimise building efficiency and drive savings.

Plug and Play BMS connection.

With the SER8150, connection to BMS is extremely easy. Better still, a remote controller is all that's needed to enable use as a stand-alone system. In addition to dramatically reducing the burden on system integrators, this cuts costs.

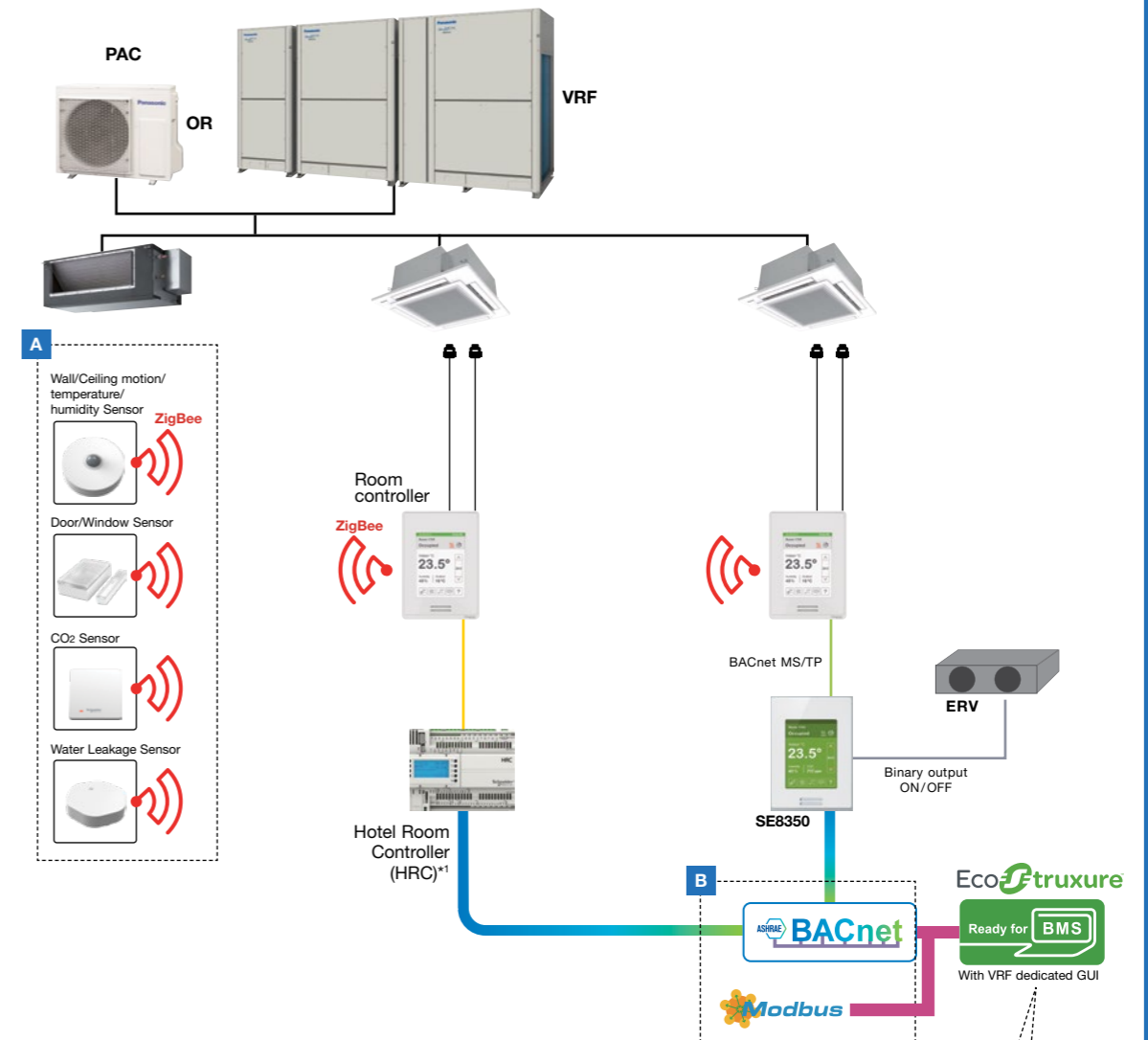

- A** SER8150 smart controller with direct hub to ZigBee® Pro sensors. Great Occupancy and IAQ control. Ex: Hotel room occupancy check by PIR sensor, IAQ by CO₂ sensor, Door / Window contacts.
- B** BACnet MS/TP or Modbus RTU communication are selectable
- C** For Schneider Electric BMS connection, Panasonic VRF widgets enable easy Plug and Play. Better understanding for VRF as a chiller system.

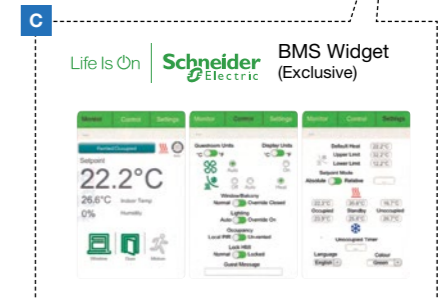

*2 Graphic shows combination of products from Panasonic, Schneider Electric and others. Currently, some products might not available in Australia, please consult authorised dealer for more details.

Smart Management Solutions

1 Hotels

Room Key Card or Key Cardless Solutions for Hotels

The SER8150 and ZigBee Sensor automatic detection function offer optimal air conditioning regardless of whether there is a hotel room key or not. Sensors detect the presence or absence of occupants and the opening and closing of doors and windows for the optimum air-conditioned environment guests expect. Automatic control ensures the most efficient operation when guests are away or when windows are open. This contributes to an appreciable reduction in operation costs.



2 Small and Medium Offices



CO2 sensors (option) and Humidity sensors

CO2 sensors (option) take measurements in units of ppm, and humidity sensors enable fine air quality control. This creates the most comfortable space for occupants while contributing to improved employee satisfaction.

3 Super Markets



Humidity sensors

Humidity sensors enable automatic dehumidification for the optimum IAQ regardless of climatic conditions. This creates an even more comfortable environment for customers, employees, and products themselves.

1. Remote sensing & IAQ control

In addition to detecting a room's temperature, humidity and CO2 concentration, ZigBee remote sensors detect the opening/closing of windows and doors, and the presence/absence of people in a room. Various IAQ controls and detailed energy savings are possible by using SE8350 based on this detected information.

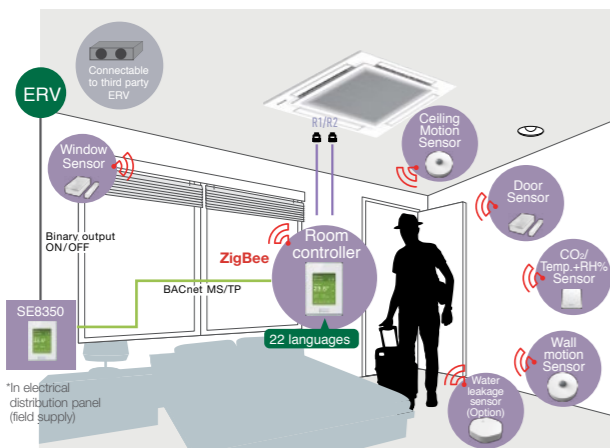

2. BMS connectivity

By setting HRC*1 as the guestroom controller, sensing, control and BMS connection can be realized in coordination with SER8150!

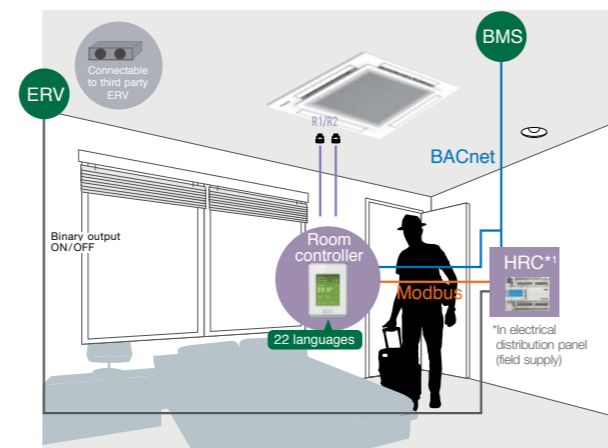

3. Key Cardless control

The introduction of SE8350 and HRC enables conventional wired keycards to be connected to the system so that it is possible to meet the specific requirements of various hotel and room types.

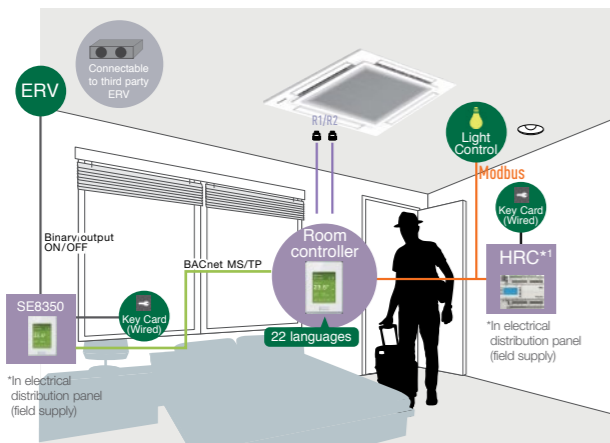

4. Other control

The introduction of SE8350 and HRC enables the on/off control of devices having dry contact input, such as ventilation, lighting and blinds.

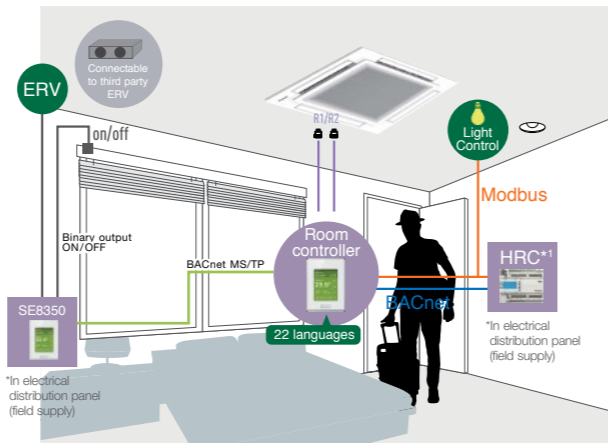

Innovative and Unrivalled Advantages

Colour and Design to Match Office Interiors

Colour combinations and design can be set to match different facilities.



Customisation in 22 Languages Possible

The display can be customised to match the native languages of guests to enable smooth, stress-free communication for hospitality at its finest.



Easy-to-Understand Error Description

Error description during an emergency is easy to understand, enabling staff to respond quickly.



Programmable Logic

Full customisation of remote control logic possible, and updating to match conditions.

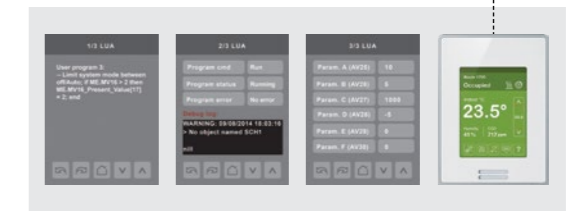

Smart Connectivity Devices

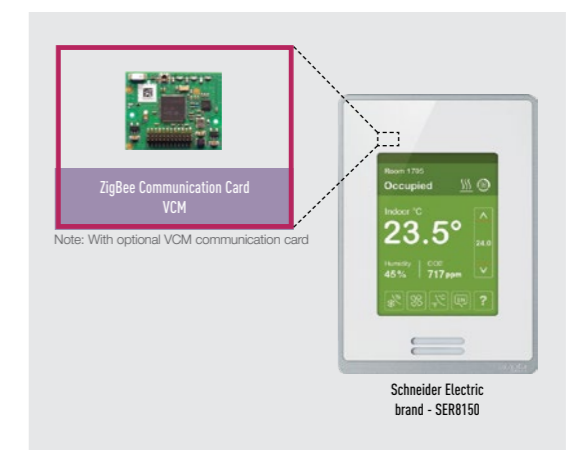

- Features**
- Up to 5-year battery life batteries included (CO2 sensor is 10 years)
 - Battery level is a point
 - Sensor points visible when SER8150 is integrated via BACnet MS/TP
 - Sensor status and battery level visible when SER8150 is integrated via ZigBee® Pro

*1 Available through a Schneider Electric distribution channel.

Panasonic AC Smart Cloud

With Panasonic AC Smart Cloud, have your business under control, and start saving!



Key functions and uniqueness

Multi sites monitoring

- It doesn't matter how many sites you have, easy to manage, operate, compare sites, locations, rooms.



Schedule setting

- Yearly / weekly / holiday timer setting as you want



Powerful statistics for energy savings

- Power consumption, capacity, efficiency level can be compared with different parameters (Yearly / monthly / weekly / daily bases)



Maintenance notification

- Error notification by email and with floor layout
- Maintenance notification of PAC / VRF outdoor units
- Remote service checker function



User customisation*2

Site administrator can create users as desired and assign customised profiles.

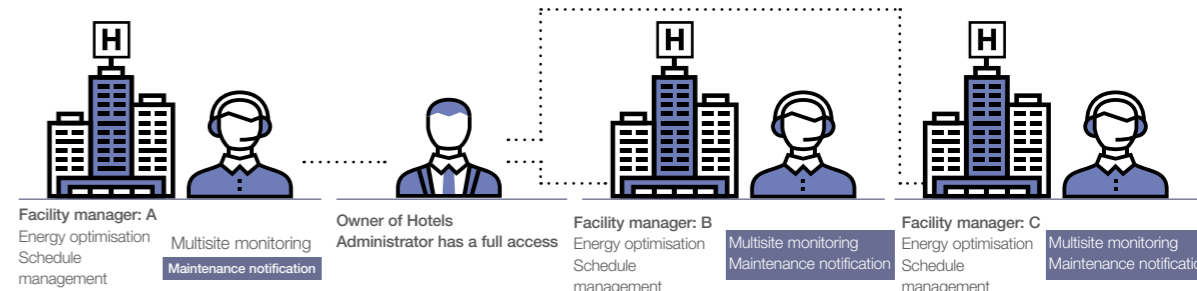

Flexible and scalable solution

- Energy saving
- Zero downtime
- Site(s) management

Centralise control of your business premises, from wherever you are, 24/7/365. It doesn't matter how many sites you have, or where they are! The AC Smart Cloud system from Panasonic allows you to have complete control of all your installations, from your tablet or from your computer. In a simple click, all your units from several locations, receive status updates in real-time of all your installations, preventing breakdowns and optimising costs.

Flexible solution for your business.

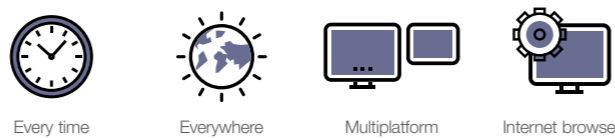

Scalable solution for your business.



*1 Customised to meet user demand / Continuous upgrades: new functions and product introductions / IT smart management.

Panasonic AC Smart Cloud offers continuous improvement always thinking about users

New e-CUT function

E-CUT functions are newly available in Panasonic AC Smart Cloud. 5 energy saving settings reduces automatically its energy consumption.

1. Set temperature auto return. When you want to return to the set temperature after a certain time even if the temperature is changed.
2. Unattended auto shut OFF. When you want to operate outside of a schedule but to monitor and stop automatically.
3. Set temperature range limit. When you want to limit the temperatures that can be set.
4. Energy saving timer / Efficient operation setting. Specify time slots when you want operation capacity reduced.
5. Demand / peak shaving settings/ Peak cut settings. Specify time slots when you want operation capacity of the outdoor units reduced.

Main functions per user type

Function / Main Tab	Sub-Tab	Basic type (Eg.: Owners, facility managers)	Professional type (Eg.: Installers, maintenance companies)
AC setting	I_U / O_U operation details	✓	✓
	Cloud adapter (CZ-CFUSCC1) details	✓	✓
	AC maintenance	✓	✓
	Map view	✓	✓
Energy saving function	NEW e-CUT	✓	✓
	Yearly, weekly schedule setting / view	✓	✓
Schedule	Power consumption	✓	✓
	Capacity	✓	✓
Powerful statistics	Efficiency ranking	✓	✓

Function / Main Tab	Sub-Tab	Basic type (Eg.: Owners, facility managers)	Professional type (Eg.: Installers, maintenance companies)
Maintenance function	Notification overview / details	✓	✓
	Maintenance settings	✓	✓
	Map view	✓	✓
	Remote service checker	✓	✓
User account *2	New / update user registration	✓	✓
	Distribution group overview / details	✓	✓
System setting	Cut OFF request	✓	✓
	Map editor	✓	✓

*2 Cloud service fee is additionally required. Please contact an authorised Panasonic dealer.

Remote service checker function

- Zero down time**
 - Quick analysis & response
 - Time & Cost saving for service maintenance task

Recording service checker parameters from wherever you are!

- Data duration: Maximum 120 minutes
- Data frequency: 10 - 90 seconds
- Mode selection: With test run or Without test run
- Count down schedule setting available

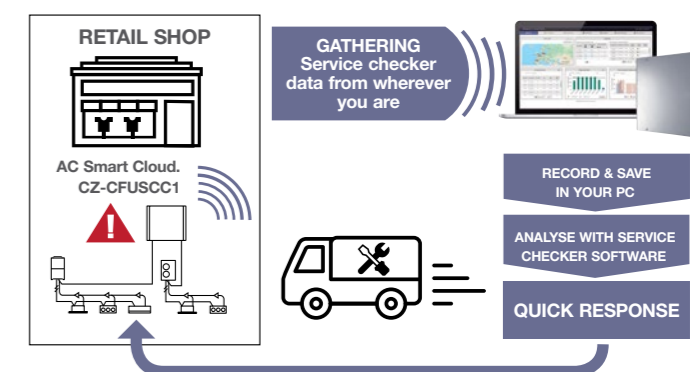

Panasonic AC Smart Cloud parts lists

CZ-CFUSCC1 AC Smart Cloud communication adaptor. Up to 128 groups. 128 units control

Note: Please contact an authorized Panasonic dealer.

Controllers

A wide variety of control options to meet the requirements of different applications.

Next Generation Control Solutions



WLAN Control







Smart Cloud Control













BMS Plug & Play

Note: Additional accessories or devices are required. Please consult Panasonic for details.

OPERATION SYSTEM	INDIVIDUAL CONTROL SYSTEMS				
Requirements	Simplified high-spec operation	Zone controller for residential	High-spec operation	Normal operation	Operation from anywhere in the room
External appearance					
Type, model name	Simplified high-spec Wired Remote Controller CZ-RTC6WBL*1 CZ-RTC6BL CZ-RTC6WBLW*1 CZ-RTC6BLW	Zone controller CZ-RTC6WZ*1 CZ-RTC6Z	Deluxe Wired Remote Controller CZ-RTC5B	Timer Remote Controller (Wired) CZ-RTC4	Wireless Remote Controller Controller: CZ-RWS3 Receiver: CZ-RWRU3 CZ-RWRL3 CZ-RWRD3 CZ-RWRT3 CZ-RWRC3
Built-in thermostat	●	●	●	●	—
nanoe™ X on/off control *not applies to Floor Console	●	●	●	—	●
ECONAVI on/off control	●	—	●	●	●
Number of indoor units which can be controlled	1 group, 8 units	1 Unit	1 group, 8 units	1 group, 8 units	1 group, 8 units
Use limitations	<ul style="list-style-type: none"> CZ-RTC6WBL*1/CZ-RTC6BL : Up to 2 controllers can be connected per group(no combination possible with CZ-RTC6WBLW*1/ CZ-RTC6BLW) CZ-RTC6WBLW*1/ CZ-RTC6BLW :Up to 1 controller can be connected per group 	<ul style="list-style-type: none"> Up to 2 controllers can be connected Main/sub 	<ul style="list-style-type: none"> Up to 2 controllers can be connected per group (When using ECONAVI sensor, only one remote controller is possible to connect at indoor unit) 	<ul style="list-style-type: none"> Up to 2 controllers can be connected per group. (When using ECONAVI sensor, only one remote controller is possible to connect at indoor unit) 	<ul style="list-style-type: none"> Up to 2 controllers can be connected per group.
Function ON/OFF	●	●	●	●	●
Mode setting	●	●	●	●	●
Fan speed setting	●	●	●	●	●
Temperature setting	●	●	●	●	●
Air flow direction	●	—	●	●	●*2
Permit/Prohibit switching	—	—	—	—	—
Weekly program	●*3	● <small>Comfort Cloud APP Only.</small>	●	●	—

*1 Launched in 4th Quarter in CY23. The above image is a new white model. Black models are also available.
 *2 Setting is not possible when a remote controller unit is present (use the remote controller for setting).
 *3 CZ-RTC6WBL*1 or CZ-RTC6BL with H&C Control App, CZ-RTC6WBLW*1 or CZ-RTC6BLW with H&C Control App or Comfort Cloud App.

CENTRALISED CONTROL SYSTEMS			SMART CONTROL SYSTEMS		
Operation with various function from centre station	Only ON/OFF operation from centre station	Simplified load distribution ratio (LDR) for each tenant Touch screen panel	Connection with 3rd Party Controller	Cloud connectivity, operation from anywhere	Schneider Electric room controller
					
System Controller CZ-64ESMC3	ON/OFF Controller CZ-ANC3	Intelligent Controller CZ-256ESMC3 (CZ-CFUNC2)	Seri-Para I/O unit for outdoor unit CZ-CAPDC2	WLAN Smart Adaptor Comfort Cloud App CZ-TACG1 / CZ-CAPWFC1	PAC smart connectivity+ SER8150 (room controller)
—	—	—		—	●
—	—	—	CZ-CAPC3	●	—
●	—	●	Seri-Para I/O unit for each indoor unit	●	—
64 groups, max. 64 units	16 groups, max. 64 units	64 units x 4 links, max. 256 units		1 adaptor : 1 group, 8 units. Multiple adaptors for each indoor units : 200 units (10 location x 20 units)	1 group, 8 units
<ul style="list-style-type: none"> Up to 10 controllers, can be connected to one system. Main unit/sub unit (1 main unit + 1 sub unit) connection is possible. Use without remote controller is possible. 	<ul style="list-style-type: none"> Up to 8 controllers (4 main units + 4 sub units) can be connected to one system. Use without remote controller is impossible. 	<ul style="list-style-type: none"> A communication adaptor (CZ-CFUNC2) must be installed for three or more links. 	CZ-CAPBC2	<ul style="list-style-type: none"> Mobile device, free App and internet router is required separately. Wired remote controller (master) required. 	<ul style="list-style-type: none"> Comparing to RTC5B, up to 1 controller can be connected per IDU. Wired to R1/R2. VRF and PAC(S-link) model only.
●	●	●	Communication Adaptor	●	●
●	—	●		●	●
●	—	●	CZ-CFUNC2	●	●
●	—	●	LonWorks Interface	●	●
●*2	—	●*2		●	●
●	●	●	CZ-CLNC2	●	●
●	—	●	—	—	—
●	—	●	—	●	—

Note: Product images not to scale.

New wired RC & Monitor adaptor & App compatibility**

**1 End User App Recommendation
CZ-RTC6WBL*2 - H&C Control App
CZ-RTC6WBLW*3 - Comfort Cloud App

		Wired RC BLUETOOTH	Wired RC BLUETOOTH & WLAN	WLAN adaptor	Monitor adaptor for diagnosis
		 CZ-RTC6WBL*2 Bluetooth	 CZ-RTC6WBLW*3 Bluetooth	 CZ-CAPWFC1	 New service checker Bluetooth
PZH2 / PZ2 series		✓	✗	✓	✗
NX series	PZH3 / PZ3 Series ODU ✗ NX series IDU	✓	✓	✓	✓
	PZH2 / PZ2 series ODU ✗ NX series IDU	✓	✓	✓	✗

*2 Launched in 4th Quarter in CY23. A black model (CZ-RTC6BL) is also available.
*3 Launched in 4th Quarter in CY23. A black model (CZ-RTC6BLW) is also available.
Note: Power supply is available only when using NX IDU
4 New Zone controller (CZ-RTC6WZ) can be connected with 3.6 kW to 22.4 kW Ducted (PE3, PF3 and PE4) Indoors and VRF Ducted (M1, E1, E2, E1R, F2, F3 and Z1) Indoors.
*5 Launched in 4th Quarter in CY23. A black model (CZ-RTC6Z) is also available.
*6 Connectable to selected Panasonic ducted models only, please consult Panasonic for more details

Timer remote controller (CZ-RTC4)



Dimensions
H 120 x W 120 x D 20 mm

Basic remote controller ON/OFF

- Operation mode changeover (Cooling, Heating, Dry, Auto, Fan).
- Temperature setting (Cooling / Dry: 18-30 °C Heating: 16-30 °C).
- Fan speed setting H / M / L and Auto.
- Air flow direction adjustment.
- ECONAVI on / off*7

Time Function 24 hours real time clock

- Day of the week indicator.

Weekly Programme Function

- A maximum of 6 settings/day and 42 settings/week can be programmed.

Outing Function

- This function can prevent the room temperature from dropping or rising when the occupants are out for a long time.

Sleeping Function

- This function controls the room temperature for comfortable sleeping.

Maximum 8 indoor units can be controlled from one remote controller

Remote control by main remote controller and sub controller is possible

Maximum 2 remote controllers (main remote controller and sub controller) can be installed for one indoor unit.

*7 Depending on the model, some menus cannot be used.

Note: Product images not to scale.

Wireless remote controller



For 4-WAY Cassette type
CZ-RWS3
+CZ-RWRU3



For all Ducted types
CZ-RWS3
+CZ-RWRC3



For Under Ceiling type
CZ-RWS3
+CZ-RWRT3

Remote control by main remote controller and sub controller is possible

- Maximum 2 remote controllers (main remote controller and sub controller) can be installed for one indoor unit.

When CZ-RWS3+CZ-RWRC3 is used, wireless control becomes possible for all indoor units

- When a separate receiver is set up in a different room, control from that room also becomes possible.
- Automatic operation by means of the emergency operation button is possible even when the remote controller has been lost or the batteries have been exhausted.

In addition, there are other functions such as temperature setting, operation switching, wind direction/fan speed setting, etc

Ventilation independent operation is possible

When commercial ventilation fans or heat-exchange ventilation fans have been installed, they can be operated with this remote control (interlocked operation with the indoor unit or independent ventilation ON/OFF).

Note: Product images not to scale.

T10 Terminal for External Control (Digital Connection)

Connecting an indoor unit to an external device is easy. The T10 Terminal featured in the electronic circuit board of all indoor units enables digital connection to external devices.



1. T10 Terminal Specification (T10:CN061 at indoor unit PCB)

- Control items:
 1. Start/stop input
 2. Remote controller prohibit input
 3. Start signal output
 4. Alarm signal output

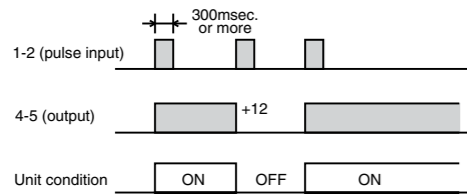

NOTE: The wire length from indoor unit to the Relay must be within 2.0m. Pulse signal changeable to static with JP cutting. (Refer to JP001)

Example of wiring

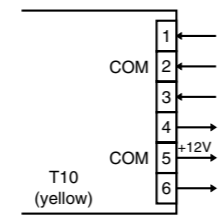

Condition

- 1-2 (Pulse input): Unit ON/OFF condition switching with a pulse signal. (1 pulse signal: shortage status more than 300msec.or more)
- 2-3 (Static input): Open/ Operation with Remote is permitted.(Normal condition) Close/ Remote controller is prohibited.
- 3-4-5 (Static output): 12V output during the unit ON. / No output at OFF.
- 4-5-6 (Static output): 12V output when some errors occur / No output at normal.

2. Usage Example

Forced OFF control

Condition

1-2 (Static input): Close/ Operation with Remote is permitted. (Normal condition) Open/ Unit is forcibly OFF and Remote controller operation is prohibited.

Example of wiring

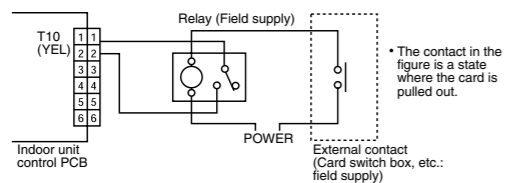

Note: The wire length from indoor unit to the Relay must be within 2.0m

Operation ON/OFF signal output

Condition

4-5 (Static output): 12V output during the unit ON / No output at OFF

Example of wiring

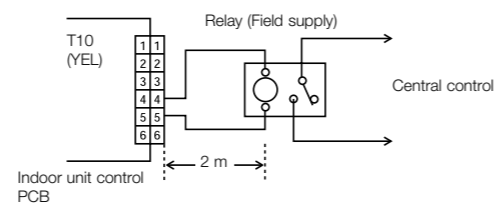

Note: The wire length from indoor unit to the Relay must be within 2.0m. Pulse signal changeable to static with JP cutting. (Refer to JP001)