

Panasonic

air-eTM
FV-15CSD1

PURIFY YOUR AIR
CEILING MOUNTED
air-e nanoeTMX GENERATOR



DEODORISES & INHIBITS BACTERIA, VIRUSES, MOULD, POLLENS & ALLERGENS
FOR BETTER INDOOR AIR QUALITY

QUALITY AIR FOR LIFE

nanoeXTM



The daily indoor activities which we undertake generate various odours and smells, which can impact our comfort levels. The pollutants which we bring in from outside also have consequences to the indoor air quality. Additionally the growth of mould in humid seasons may cause allergic problems for some people. All these factors can result in the quality of our indoor air being as bad if not worse than the outside air quality.



Smoke



Bacteria



Pollen



Mould



Viruses



Odours

**PURIFY THE INDOOR AIR WITH PANASONIC'S UNIQUE nanoe™X TECHNOLOGY
BUILT INTO THE
air-e (nanoe™X GENERATOR)**



Homes



Hotels



Retail Outlets



Aged Care



Child Care/Schools



Gyms



Offices



Hospitals



Restaurants

WHAT IS nanoe™X?

nanoe™ = nano-technology + electric

nanoe™ are Hydroxyl Radicals (OH) inculcated in water, giving them a longer life span (up to 10 min*1). Their size is 5-20nm*2 which allows them to penetrate fabrics thoroughly and reach every corner of the room in order to inhibit pollutants like viruses and allergens etc.

The FV-15CSD1 air-e nanoe™X device generates 4.8 trillion nanoe™ per second, effectively inhibiting both adhered and airborne pollutants for an improved air quality and comfort.

*1 <https://www.panasonic.com/global/consumer/clean/hydroxyl/history.html>

*2 1nm (nanometre = 0.000000001m (one billionth of a metre))

HOW nanoe™X INHIBITS POLLUTANTS

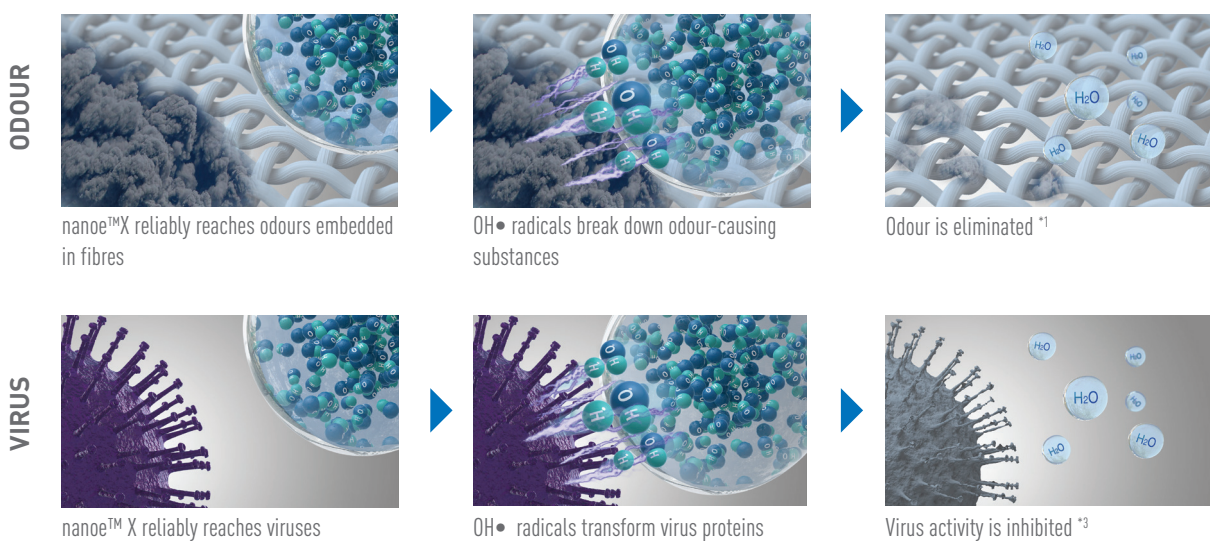

THE TESTED EFFECTS OF nanoe™X

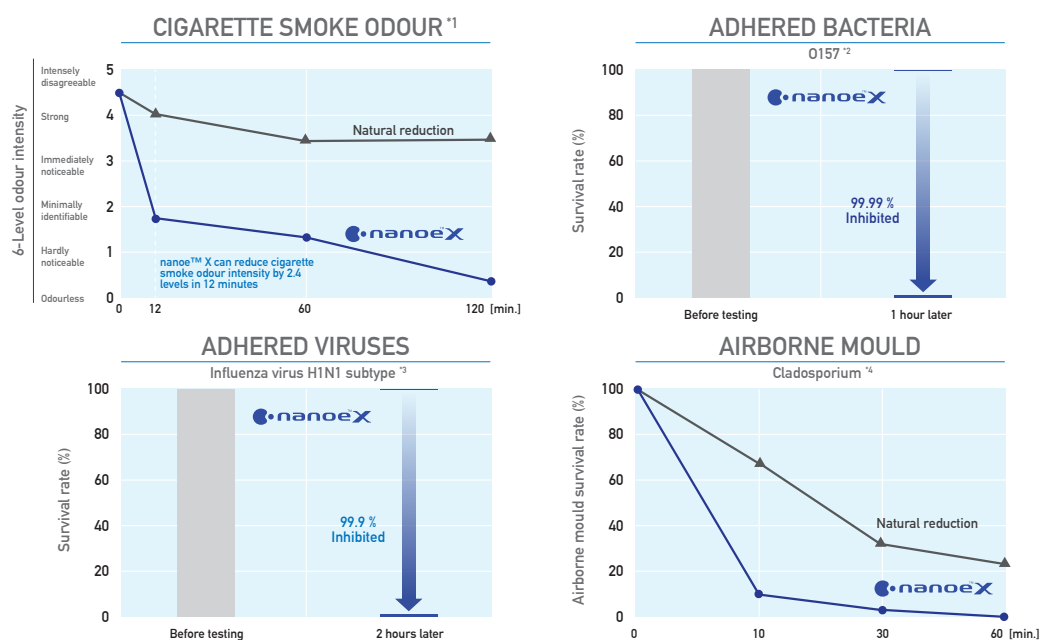

*1 <Cigarette smoke odour> [Test organisation] Panasonic Product Analysis Centre [Test method] Verified using the 6-level odour intensity scale method in an approximately 23m³ sized test room [Test method] nanoe™ released [Test substance] Surface-attached cigarette smoke odour [Test result] Odour intensity reduced by 2.4 levels in 12 min. [4AA33-160615-N04]

*2 <Adhered bacteria [O157]> [Test organisation] Japan Food Research Laboratories [Test method] Measured the number of bacteria adhered to a cloth in an approximately 45L sized airtight test room [Test method] nanoe™ released [Test substance] Adhered bacteria [Test result] Inhibited by at least 99.99% in 1 hour [208120880_001]

*3 <Adhered virus [Influenza virus H1N1 subtype]> [Test organisation] Kitasato Research Centre for Environmental Science [Test method] Measured the number of virus adhered to a cloth in an approximately 1m³ sized airtight test room [Test method] nanoe™ released [Test substance] Adhered virus [Test result] Inhibited by at least 99.9% in 2 hours [21_0084_1]

*4 <Airborne mould [Cladosporium]> [Test organisation] Japan Food Research Laboratories [Test method] Measured the number of mould altered in an approximately 23m³ sized test room [Test method] nanoe™ released [Test substance] Airborne mould [Test result] Inhibited by at least 99% in 1 hour [205061541-001]

air-e (Ceiling Mount nanoe™X Generator)

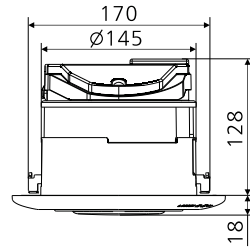

DIMENSIONS
Unit : mm

FEATURES

- nanoe™X Technology - approved by the National Asthma Council of Australia's Sensitive Choice Program
- Whisper quiet - at 27dB(A)
- Easy Installation - built-in cord & 3-pin plug
- Compact and Modern Design

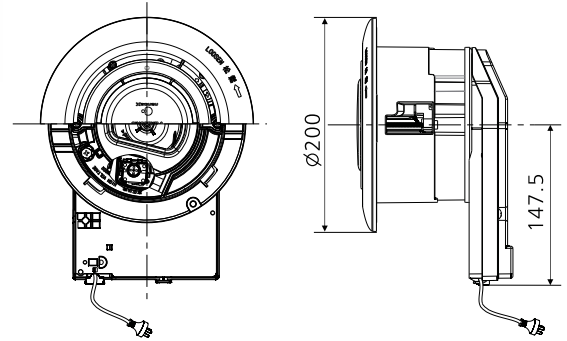







SPECIFICATIONS

Model	Electrical Supply		Air Volume	Power Consumption	Noise @1m	Weight
FV-15CSD1	240V	50Hz	4.7L/s	4W	27dB(A)	1.3kg

- The value of air volume, power consumption and noise are specified at static pressure 0Pa.
- The value of air volume is the mean value and a tolerance of +-10% is allowed.
- The value of noise level is a weighted average sound pressure level, the mean value is measured by Panasonic. A tolerance of +3dB/-7dB is allowed. The noise is measure at 1m apart from the left, the front and below of the tested product.
- Conditions of generating nanoe™X
 - Room temperature: about 5°C ~ 40°C (dew point temperature more than 2°C).
 - Relative humidity: about 30% ~ 85%.
- nanoe™X is generated using the air in the room, and its amount is subject to the temperature and humidity in the air.

EFFECTIVENESS OF nanoe™X

DEODORISES	INHIBITS 5 TYPES OF POLLUTANTS					MOISTURISES
						
Odours	Bacteria & Viruses	Mould	Allergens	Pollen	Hazardous Substances	Skin & Hair

For further details and validation data, please refer to the following website:
https://aircon.panasonic.com/introducing/whats_nanoe/nanorex.html



Please read the Installation Instructions carefully before installing the unit, and the Operating Instructions before using it. Specifications are subject to change without prior notice. The contents of this catalogue are accurate as of August 2021. Due to printing considerations, the actual colours may vary slightly from those shown. All graphics are provided merely for the purpose of illustrating a point.

21VEN0801AE

Panasonic Australia Pty. Limited

1 Innovation Road
 Macquarie Park
 NSW 2113
 ACN 001 592 187
 ABN 83 001 592 187
 Website : aircon.panasonic.com.au

Panasonic

AIR CONDITIONING