

Panasonic®

Operating Instructions

Home Theater Audio System

Model No. **SC-HTB258**
SC-HTB250
SC-HTB208
SC-HTB200

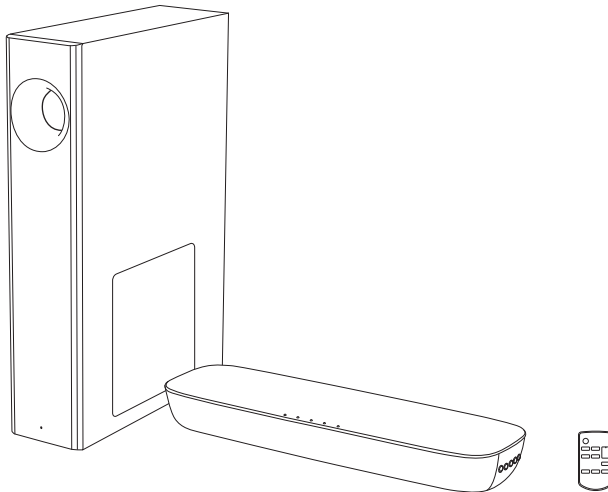

This illustration shows SC-HTB250.

Thank you for purchasing this product.
For optimum performance and safety, please read these instructions carefully.
Please keep this manual for future reference.

"EB" indicates the United Kingdom model.

EB **EG** **GN**

TQBJ2086

Safety precautions

WARNING!

Unit

- To reduce the risk of fire, electric shock or product damage,
 - Do not expose this unit to rain, moisture, dripping or splashing.
 - Do not place objects filled with liquids, such as vases, on this unit.
 - Use the recommended accessories.
 - Do not remove covers.
 - Do not repair this unit by yourself. Refer servicing to qualified service personnel.

AC mains lead

- To reduce the risk of fire, electric shock or product damage,
 - Ensure that the power supply voltage corresponds to the voltage printed on this unit.
 - Insert the mains plug fully into the socket outlet.
 - Do not pull, bend, or place heavy items on the lead.
 - Do not handle the plug with wet hands.
 - Hold onto the mains plug body when disconnecting the plug.
 - Do not use a damaged mains plug or socket outlet.

Small objects

- Keep the speaker feet out of reach of children to prevent swallowing.

Button-type battery (Lithium battery)

- Risk of fire, explosion and burns. Do not recharge, disassemble, heat above 60°C or incinerate.



WARNING
DO NOT INGEST BATTERY,
CHEMICAL BURN HAZARD

This remote control contains a coin/button cell battery. If the coin/button cell battery is swallowed, it can cause severe internal burns in just 2 hours and can lead to death. Keep new and used batteries away from children. If the battery compartment does not close securely, stop using the remote control and keep it away from children. If you think batteries might have been swallowed or placed inside any part of the body, seek immediate medical attention.

CAUTION!

Unit

- To reduce the risk of fire, electric shock or product damage,
 - Do not install or place this unit in a bookcase, built-in cabinet or in another confined space. Ensure this unit is well ventilated.
 - Do not obstruct this unit's ventilation openings with newspapers, tablecloths, curtains, and similar items.
 - Do not place sources of naked flames, such as lighted candles, on this unit.
- This unit is intended for use in moderate climates.
- This unit may receive radio interference caused by mobile telephones during use. If such interference occurs, please increase separation between this unit and the mobile telephone.
- Product Identification Marking is located on the bottom of the unit.
- Set the unit up on an even surface away from direct sunlight, high temperatures, high humidity, and excessive vibration.
- This system might get warm after prolonged usage. This is normal. Do not be alarmed.

AC mains lead

- The mains plug is the disconnecting device. Install this unit so that the mains plug can be unplugged from the socket outlet immediately.

Button-type battery (Lithium battery)

- Danger of explosion if battery is incorrectly replaced. Replace only with the type recommended by the manufacturer.
- When disposing of the batteries, please contact your local authorities or dealer and ask for the correct method of disposal.
- Do not heat or expose to flame.
- Do not leave the battery(ies) in a car exposed to direct sunlight for a long period of time with doors and windows closed.
- Insert with poles aligned.
- Remove the battery if you do not use the remote control for a long period of time. Keep in a cool, dark area.

Caution for AC mains lead

(For the AC mains plug of three pins)

For your safety, please read the following text carefully.

This appliance is supplied with a moulded three pin mains plug for your safety and convenience. A 5-ampere fuse is fitted in this plug. Should the fuse need to be replaced please ensure that the replacement fuse has a rating of 5-ampere and that it is approved by ASTA or BSI to BS1362.

Check for the ASTA mark  or the BSI mark  on the body of the fuse.

If the plug contains a removable fuse cover you must ensure that it is refitted when the fuse is replaced.

If you lose the fuse cover the plug must not be used until a replacement cover is obtained. A replacement fuse cover can be purchased from your local dealer.

Before use

Remove the connector cover.

How to replace the fuse

The location of the fuse differ according to the type of AC mains plug (figures A and B). Confirm the AC mains plug fitted and follow the instructions below.

Illustrations may differ from actual AC mains plug.



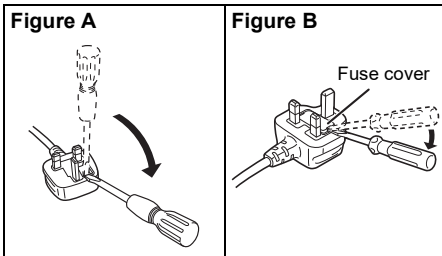

1. Open the fuse cover with a screwdriver.

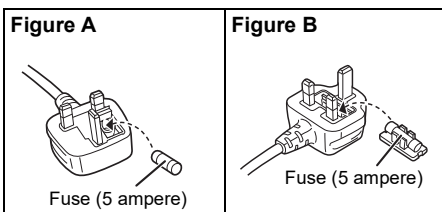

2. Replace the fuse and close or attach the fuse cover.



The symbols on this product (including the accessories) represent the following:

	AC
	Class II equipment (The construction of the product is double-insulated.)
	ON
	Standby

Sales and Support Information

For the United Kingdom and Ireland

Customer Communications Centre

- For customers within the UK: 0344 844 3899
- For customers within Ireland: 01 289 8333
- Monday – Friday 9:00am – 5:00pm (Excluding public holidays).
- For further support on your product, please visit our website: www.panasonic.co.uk

Direct Sales at Panasonic UK

- Order accessory and consumable items for your product with ease and confidence by phoning our Customer Communications Centre Monday – Friday 9:00am – 5:00pm (Excluding public holidays).
- Or go on line through our Internet Accessory ordering application at www.pas-europe.com.
- Most major credit and debit cards accepted.
- All enquiries transactions and distribution facilities are provided directly by Panasonic UK.
- It couldn't be simpler!
- Also available through our Internet is direct shopping for a wide range of finished products. Take a browse on our website for further details.

Table of contents

Safety precautions	2
Caution for AC mains lead	3
Sales and Support Information	3
Supplied items	4
References	5
Placement	5
Overview of controls	7
Making the connections	9
Basic control	12
Advanced operations	12
HDMI CEC	14
Troubleshooting	14
Unit care	16
Indicators illumination	17
Specifications	18
Limited Warranty (For Australia only)	23

HTB258: Indicate features applicable to SC-HTB258 only.

HTB250: Indicate features applicable to SC-HTB250 only.

HTB208: Indicate features applicable to SC-HTB208 only.

HTB200: Indicate features applicable to SC-HTB200 only.

Supplied items



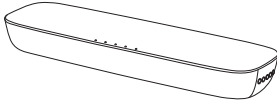
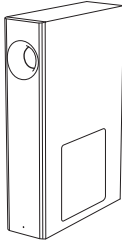

Product numbers correct as of January 2018. These may be subject to change.

This system

<p><input type="checkbox"/> 1 Main unit (speaker)</p> <p>HTB258: SU-HTB258 HTB250: SU-HTB250 HTB208: SC-HTB208 HTB200: SC-HTB200</p> 	<p><input type="checkbox"/> HTB258 HTB250</p> <p>1 Active subwoofer (SB-HWA250)</p> 
---	--

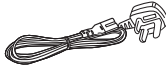
Accessories

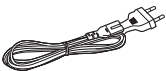
Check and identify the supplied accessories.

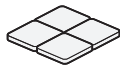
<p><input type="checkbox"/> 1 AC mains leads</p> <p>For the United Kingdom and Ireland (TSXA170)</p>  <p>For Australia and New Zealand (TSXA172)</p>  <p>For others (TSXA168)</p> 	<p><input type="checkbox"/> 1 Remote control (with a battery)</p> <p>HTB258 HTB250 (N2QAYC000126)</p>  <p>HTB208 HTB200 (N2QAYC000123)</p> 	<p><input type="checkbox"/> HTB258 HTB250</p> <p>4 Speaker feet (for active subwoofer) (TMKK727)</p> 
---	--	---

References

About Bluetooth®

Panasonic bears no responsibility for data and/or information that is compromised during a wireless transmission.

Frequency band

- This system uses the 2.4 GHz frequency band.

Certification

- This system conforms to the frequency restrictions and has received certification based on frequency laws. Thus, a wireless permit is not necessary.
- The actions below are punishable by law in some countries:
 - Taking apart or modifying the unit.
 - Removing specification indications.

Restrictions of use

- Wireless transmission and/or usage with all Bluetooth® equipped devices is not guaranteed.
- All devices must conform to standards set by the Bluetooth SIG, Inc.
- Depending on the specifications and settings of a device, it can fail to connect or some operations can be different.
- This system supports Bluetooth® security features. But depending on the operating environment and/or settings, this security is possibly not sufficient. Transmit data wirelessly to this system with caution.
- This system cannot transmit data to a Bluetooth® device.

Range of use

- Use this device at a maximum range of 10 m.
- The range can decrease depending on the environment, obstacles or interference.

Interference from other devices

- This system may not function properly and troubles such as noise and sound jumps may arise due to radio wave interference if this unit is located too close to other Bluetooth® devices or the devices that use the 2.4 GHz band.
- This system may not function properly if radio waves from a nearby broadcasting station, etc. is too strong.

Intended usage

- This system is for normal, general use only.
- Do not use this system near an equipment or in an environment that is sensitive to radio frequency interference (example: airports, hospitals, laboratories, etc.).

Licenses

Dolby, Dolby Audio, and the double-D symbol are trademarks of Dolby Laboratories.

For DTS patents, see <http://patents.dts.com>.
Manufactured under license from DTS Licensing Limited.

DTS, the Symbol, & DTS and the Symbol together are registered trademarks, and DTS Digital Surround is a trademark of DTS, Inc. © DTS, Inc. All Rights Reserved.

The terms HDMI and HDMI High-Definition Multimedia Interface, and the HDMI Logo are trademarks or registered trademarks of HDMI Licensing Administrator, Inc. in the United States and other countries.

The Bluetooth® word mark and logos are registered trademarks owned by the Bluetooth SIG, Inc. and any use of such marks by Panasonic Corporation is under license. Other trademarks and trade names are those of their respective owners.

Placement

Place the main unit in a rack or on a table.

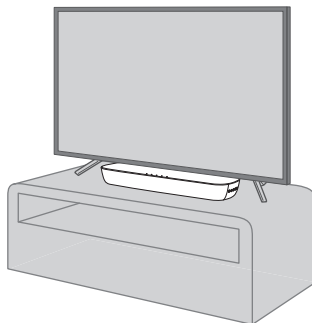

When placing the main unit in front of the TV

The main unit may block or interfere with the TV's various sensors and the 3D Eyewear transmitter of a 3D compatible TV. If interferences occur, move the main unit further away from the TV. If the TV still does not function correctly, try using it in a rack.

Placement of the active subwoofer

HTB258 HTB250

You can place the subwoofer vertically or horizontally.

Based on your option of subwoofer placement, paste the supplied speaker feet on the subwoofer accordingly.

Vertical placement

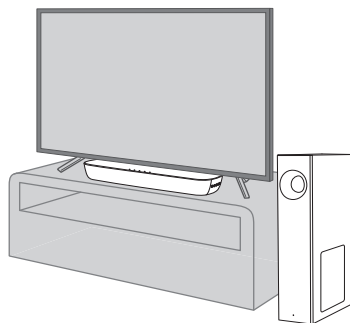
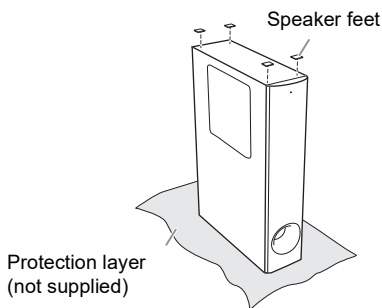

For stability and to avoid injury, when the subwoofer is placed vertically,

- Do not stack any object on the subwoofer.
- Do not allow children to climb on the subwoofer.
- Be careful when babies or children are near.



Horizontal placement

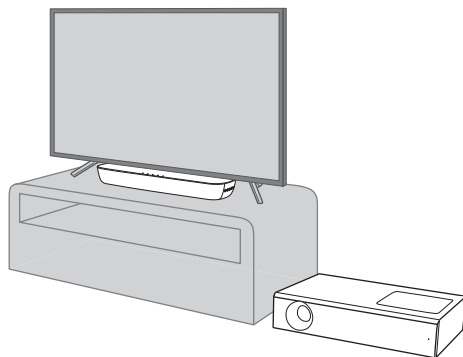
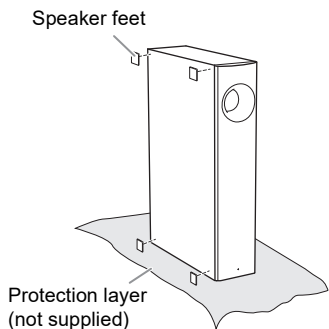

Note:

- Place the system on a flat safe surface.
- Do not put the system in a metal cabinet.
- Place the active subwoofer within a few meters from the main unit.
- Depending on the position of the active subwoofer, the effect may vary. Placing the active subwoofer too close to the walls and corners can result in excessive bass. Cover walls and windows with thick curtains. You may change the position of the active subwoofer, or adjust the subwoofer level (⇔ 12) to achieve optimum effect.
- Keep other 2.4 GHz frequency band electronic devices such as wireless router, cordless phone, etc. at least 2 m away from this system to avoid wireless interference.
- If irregular colouring occurs on the TV, switch off the TV for 30 minutes. If the demagnetising of the TV does not correct the problem, increase the distance between this system and the TV.
- Keep magnetised items away. Magnetised cards, watches, etc., can be damaged if put too near to the system.

Overview of controls

Main unit

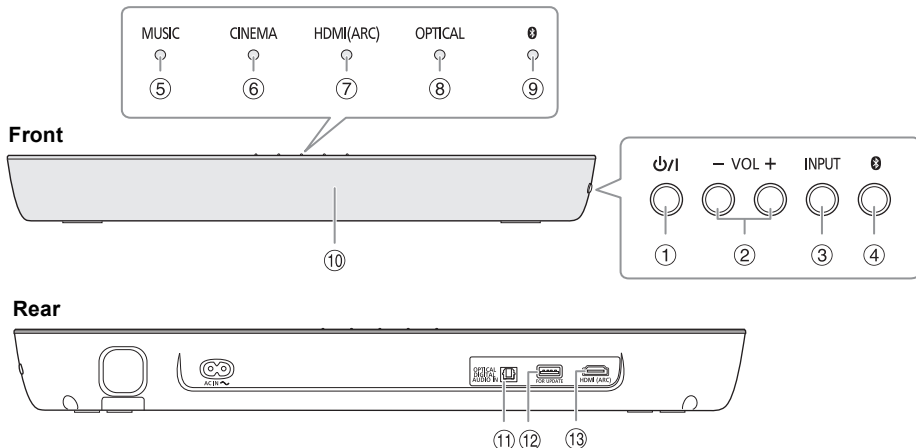

- ① **Standby/on switch** [⏻/⏻]
Press to switch the unit from on to standby mode or vice versa. In standby mode, the unit is still consuming a small amount of power.
- ② Adjust the volume level (⇒ 12)
- ③ **Select the input source**
→ HDMI (ARC) → OPTICAL → [Bluetooth symbol]
- ④ **Select the Bluetooth® device as the source**
To start Bluetooth® pairing, press and hold [Bluetooth symbol].
- ⑤ MUSIC indicator
- ⑥ CINEMA indicator
- ⑦ HDMI (ARC) indicator
- ⑧ OPTICAL indicator
- ⑨ [Bluetooth symbol] (Bluetooth®) indicator
- ⑩ **Remote control sensor**
Distance: Within approximately 7 m
Angle: Approximately 20° up and down, 30° left and right
- ⑪ OPTICAL DIGITAL AUDIO IN terminal
- ⑫ USB port (for software update) (⇒ 16)
- ⑬ HDMI (ARC) terminal (ARC compatible)

Active subwoofer

HTB258 HTB250

Front



Rear

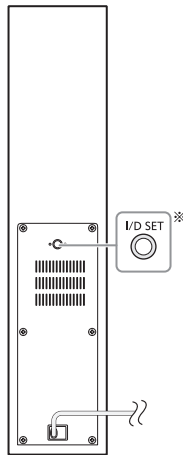

WIRELESS LINK indicator

※ The I/D SET button is only used when the main unit is not paired with the active subwoofer.

Remote control

HTB258 **HTB250**

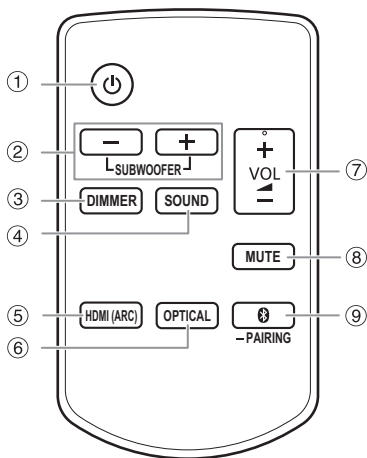

HTB208 **HTB200**

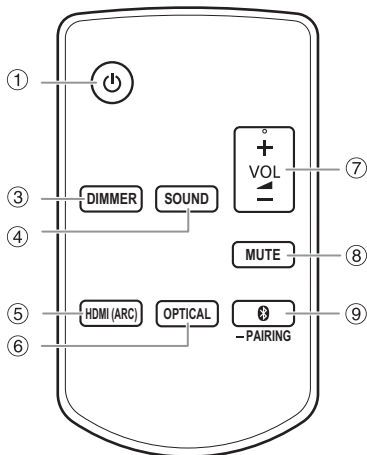

■ Preparing the remote control

Before using for the first time

Remove the insulation sheet.

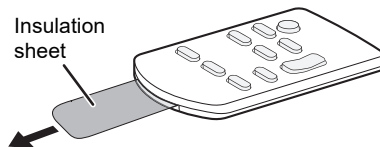

Replacing the battery

Replace with a new battery (CR2025 lithium battery).

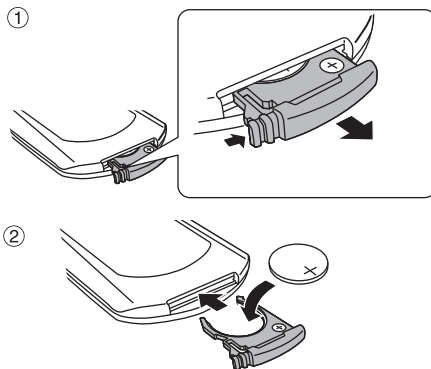

Insert a new battery with the (+) side facing up.

- ① Switch the main unit on or off
- ② **HTB258** **HTB250**
Adjust the subwoofer level (⇒ 12)
- ③ Dim the indicators on the main unit
- ④ Select the sound mode (⇒ 12)
- ⑤ Select the HDMI (ARC) device as the source
- ⑥ Select the optical device as the source
- ⑦ Adjust the volume level (⇒ 12)
- ⑧ Mute the sound (⇒ 12)
- ⑨ **Select the Bluetooth® device as the source**
To start Bluetooth® pairing, press and hold [Bluetooth symbol -PAIRING].

Making the connections

Switch off all equipment before connection.

Components and cables are sold separately.

Connect the AC mains lead only after all the other connections have been made.

Connecting the TV

■ Connect an ARC compatible TV

Connect to the ARC compatible terminal of the TV with an ARC compatible high speed HDMI cable.

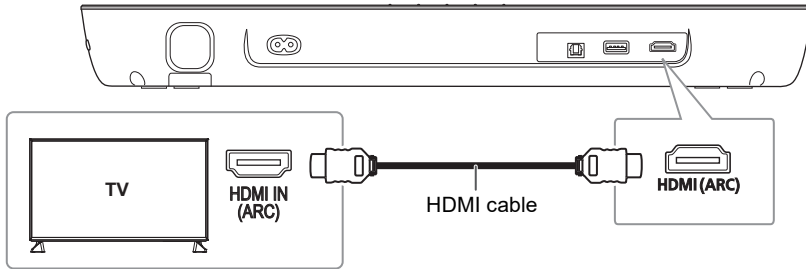

ARC (Audio Return Channel)

ARC is an HDMI function that lets you enjoy both sound and TV pictures with one HDMI cable, the optical digital audio cable that is usually required in order to listen to sound from a TV is no longer required.

■ Connect a non-ARC compatible TV

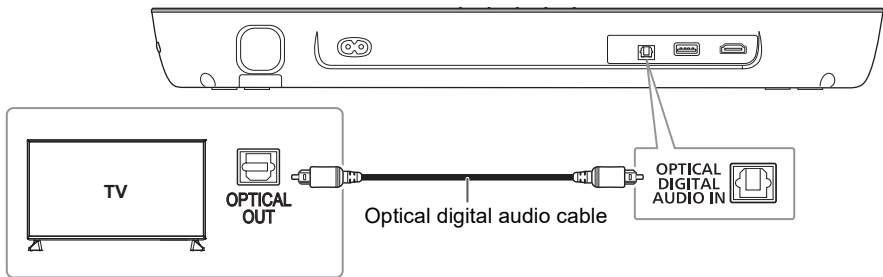

When connecting the optical digital audio cable, observe the orientation and insert the tip correctly into the terminal.

Connecting a 4K Ultra HD TV

The system cannot pass-through the 4K video signal of a 4K compatible equipment to a 4K Ultra HD TV. However, you can connect the system to a 4K Ultra HD TV to enjoy the 4K content.

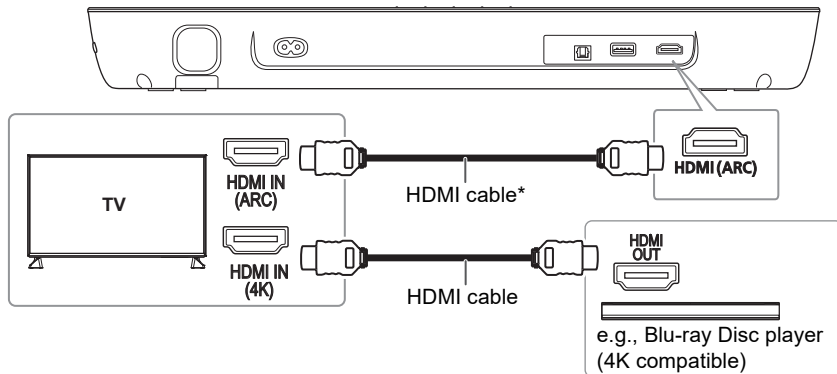

* Make sure to connect the HDMI cable to ARC compatible terminals.

Note:

- Refer to the operating instructions of the 4K Ultra HD TV (VIERA) and the 4K/60p compatible equipment for setup and for playing the 4K content.
- To enjoy multi-channel output from this system, set the audio output of other equipment to Bitstream.
- The audio signal input to this system is up to 5.1 channels.

Connecting the AC mains lead

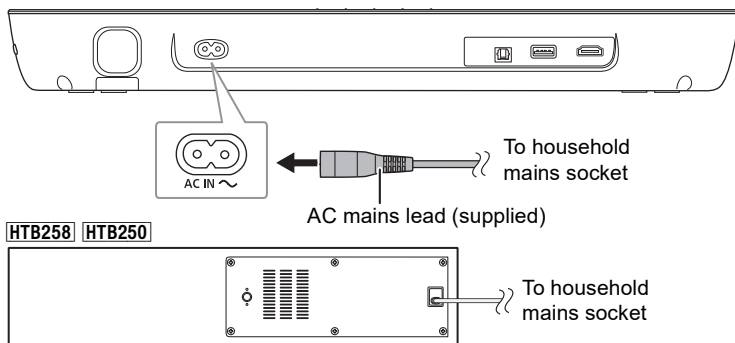

Conserving power

The system consumes a small amount of power when it is in standby mode. Disconnect the power supply if you do not use the system.

The main unit will automatically switch to standby mode when no signal is input and no operation is performed for approx. 20 minutes. Refer to page 13 "Auto power down" to switch this function off.

Note:

The active subwoofer is in the standby condition when the AC mains lead is connected. The primary circuit is always "live" as long as the AC mains lead is connected to an electrical outlet.

Bluetooth® connection

You can connect and play an audio device wirelessly through Bluetooth®.

Preparation

- Switch on the main unit.
- Switch on the Bluetooth® feature of the device and put the device near the system.
- Read the operating instructions of the device for details.

Pairing a device

Preparation

If this system is connected to a Bluetooth® device, disconnect it (⇒ right).

1 Press [-PAIRING].

If the “  ” indicator blinks quickly, continue with step 3.

2 Press and hold [-PAIRING] until the “ ” indicator blinks quickly.

If the “  ” indicator blinks slowly, repeat this step.

3 Select “SC-HTB258”, “SC-HTB250”, “SC-HTB208” or “SC-HTB200” from the Bluetooth® menu of the device.

The MAC address (e.g., 6C:5A:B5:B3:1D:0F) may be shown before “SC-HTB258”, “SC-HTB250”, “SC-HTB208” or “SC-HTB200” is shown.

If prompted for a passkey, input “0000” or “1234”.

Once the Bluetooth® device is connected, the “  ” indicator stops blinking and lights up.

Note:

You can pair up to 8 devices with this system. If a 9th device is paired, the device that has not been used for the longest time will be replaced.

Connecting a paired device

Preparation

If this system is connected to a Bluetooth® device, disconnect it (⇒ right).

1 Press [-PAIRING].

2 Select “SC-HTB258”, “SC-HTB250”, “SC-HTB208” or “SC-HTB200” from the Bluetooth® menu of the device.

Disconnecting a device

Press and hold [ -PAIRING] until the “  ” indicator blinks slowly.

Note:

- This system can only connect to one device at a time.
- When “  ” is selected as the source, this system will automatically try to connect to the last connected device.
- The Bluetooth® device will be disconnected when you select another source.

Active subwoofer wireless connection

HTB258 **HTB250**

Preparation

Switch on the main unit.

Check that the wireless link is activated.

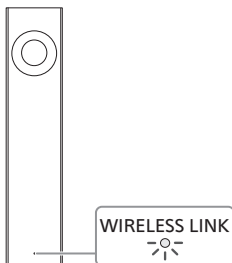

WIRELESS LINK indicator

Lights up: The wireless link is activated.

Lights off: The wireless link is not activated.

Blinks: The active subwoofer is trying to activate the wireless link with the main unit.

Note:

- The wireless link will be activated when the main unit and the active subwoofer are both switched on.
- The I/D SET button is only used when the main unit is not paired with the active subwoofer. (⇒ 16)

Basic control

Preparation

Switch on the TV and/or connected device.

1 Press [⏻] to switch on the system.

2 Select the source.

HDMI: Press [HDMI (ARC)] on the remote control or [INPUT] on the main unit.

OPTICAL: Press [OPTICAL] on the remote control or [INPUT] on the main unit.

Ⓜ (Bluetooth®): Press [Ⓜ -PAIRING] on the remote control or [Ⓜ] on the main unit.

3 Press [+ VOL -] to adjust the volume of the system.

Volume range: 0 to 100

The indicators will scroll every time you adjust the volume, and stop blinking when reached the minimum or maximum level.



When “Ⓜ” is selected as the source

Select this system as the output speaker from the menu of the connected Bluetooth® device.

When “OPTICAL” is selected as the source

On the TV and the connected device, select the TV's input for this system and starts playback on the connected device.

To select the sound mode

Press [SOUND].

Sound mode	Indication
Standard Best suited for dramas and comedy shows.	MUSIC CINEMA ● ●
Music Enhance the sound of musical instruments and songs.	MUSIC CINEMA -○- ●
Cinema (default) Produces three-dimensional sound unique to movies.	MUSIC CINEMA ● -○-

To mute the sound

Press [MUTE].

All indicators blinks simultaneously.

To cancel, press [MUTE] again or adjust the volume.

To adjust the subwoofer level

HTB258 HTB250

Press [SUBWOOFER +] or [SUBWOOFER -] to adjust the level.

Indication				Effect levels	
MUSIC -○-	CINEMA -○-	HDMI(ARC) -○-	OPTICAL -○-	4	Highest
MUSIC -○-	CINEMA -○-	HDMI(ARC) -○-	OPTICAL ●	3	↕
MUSIC -○-	CINEMA -○-	HDMI(ARC) ●	OPTICAL ●	2	
MUSIC -○-	CINEMA ●	HDMI(ARC) ●	OPTICAL ●	1	

Advanced operations

Dual audio

Sets the preferred audio channel mode when there are two audio modes received by this system.

Press and hold [MUTE] for a minimum of 4 seconds.

Audio mode	Indication				
Main (default)	MUSIC -○-	CINEMA ●	HDMI(ARC) ●	OPTICAL ●	Ⓜ ●
Secondary	MUSIC ●	CINEMA ●	HDMI(ARC) -○-	OPTICAL ●	Ⓜ ●
Main + Secondary	MUSIC -○-	CINEMA ●	HDMI(ARC) -○-	OPTICAL ●	Ⓜ ●



Note:

- This effect only works if the audio output of the TV or player is set to “Bitstream” and “Dolby Dual Mono” is available in the sound source.
- The indicator for the selected setting blinks for 5 seconds and then exits the setting mode.

Audio format

You can view the current audio format.

Press and hold [SOUND] for a minimum of 4 seconds.

Audio mode	Indication
Dolby Digital	MUSIC CINEMA HDMI(ARC) OPTICAL ③  ● ● ● ●
DTS®	MUSIC CINEMA HDMI(ARC) OPTICAL ③ ●  ● ● ●
PCM	MUSIC CINEMA HDMI(ARC) OPTICAL ③ ● ●  ● ●



Note:

- The indicator for the selected setting blinks for 5 seconds and then exits the setting mode.
- The indicators may work differently if the main unit detects an unsupported audio format from the connected TV.
- This function does not work when ③ is selected as the source.

Auto power down

The main unit is automatically switched off if there is no audio input and when you do not use it for approx. 20 minutes.

Press and hold [HDMI (ARC)] for a minimum of 4 seconds to select the mode.

Mode	Indication
On (default)	MUSIC CINEMA HDMI(ARC) OPTICAL ③  ● ● ● ●
Off	MUSIC CINEMA HDMI(ARC) OPTICAL ③ ● ●  ● ●



Note:

- The indicator for the selected setting blinks for 5 seconds and then exits the setting mode.
- The setting is maintained until it is changed again.

Bluetooth® standby

This function allows you to connect a paired Bluetooth® device when the main unit is in standby mode.

Press and hold [OPTICAL] for a minimum of 4 seconds.

Mode	Indication
On	MUSIC CINEMA HDMI(ARC) OPTICAL ③ ● ● ● ● 
Off (default)	MUSIC CINEMA HDMI(ARC) OPTICAL ③ ● ●  ● ●



Note:

- The indicator for the selected setting blinks for 5 seconds and then exits the setting mode.
- The setting is maintained until it is changed again.
- If the AC mains lead is disconnected, the Bluetooth® standby function may not work. Make the setting again.

Volume limitation

The volume is set to 50 when you switch on the system although the volume is set to above 50 before it is switched off.

Press and hold [DIMMER] for a minimum of 4 seconds.

Mode	Indication
On (default)	MUSIC CINEMA HDMI(ARC) OPTICAL ③  ● ● ● ●
Off	MUSIC CINEMA HDMI(ARC) OPTICAL ③ ● ●  ● ●

Note:

- The indicator for the selected setting blinks for 5 seconds and then exits the setting mode.
- The setting is maintained until it is changed again.

HDMI CEC

This unit supports “HDMI CEC” (Consumer Electronics Control) function.

See the operating instructions for connected equipment for operational details.

Preparation

Confirm that the HDMI connection has been made. (⇒ 9, 10)

Power on link

When the TV is switched on, the main unit also switches on automatically. (This function does not work when OPTICAL or Bluetooth® is the source.)

Power off link

When the TV is switched off, the main unit also switches off automatically. (This function does not work when OPTICAL or Bluetooth® is the source.)

Volume adjustment

You can control the volume setting of this system using the volume or mute button on the TV remote control.

If the TV's speaker selection is changed to the TV speakers, the main unit's speakers are muted.

Muting will be cancelled by selecting the main unit's speakers again.

Changing speakers

When the main unit switches on, this system will be selected as the TV's speakers automatically. When you switch off the main unit, TV speakers will be automatically activated.

Note:

The operation cannot be guaranteed on all HDMI CEC equipment.

Troubleshooting

Before requesting service, make the following checks. If you are in doubt about some of the check points, or if the solutions indicated do not solve the problem, consult your dealer for instructions.

Common problems

No power

- After connecting the AC mains lead, wait about 10 seconds before switching on the main unit.
- Disconnect the AC mains lead for 10 seconds before connect again.
- After switching on the main unit, if the main unit immediately switches off, disconnect the AC mains lead and consult your dealer.
- If the main unit does not switch on when switching on TV (HDMI CEC), switch on the main unit manually.

No operations can be done with the remote control.

- Remove the insulation sheet before you use the remote control for the first time. (⇒ 8)
- Examine that the battery is installed correctly. (⇒ 8)
- The battery is weak. Replace it with a new one. (⇒ 8)
- Set the remote control code again after replacing the battery. (⇒ 16)
- Use the remote control within the correct operation range. (⇒ 7)

The system automatically switched to standby mode

- “Auto power down” function is on.
The system automatically switches to standby mode if there is no signal input and no operation is being performed for approximately 20 minutes. Refer to page 13 to switch off this function.

Bluetooth®

Pairing cannot be done.

- Check the Bluetooth® device condition.
- The device is out of the 10 m communication range. Move the device nearer to the system.

The device cannot be connected.

- The pairing of the device was unsuccessful. Do pairing again.
- The pairing of the device has been replaced. Do pairing again.
- This system might be connected to a different device. Disconnect the other device and try connecting the device again.
- The system may have a problem. Switch off the system and then switch on again.

The device is connected but audio cannot be heard through the system.

- For some built-in Bluetooth® devices, you have to set the audio output to “SC-HTB258”, “SC-HTB250”, “SC-HTB208” or “SC-HTB200” manually. Read the operating instructions of the device for details.

Sound from the device is interrupted.

- The device is out of the 10 m communication range. Move the device nearer to the system.
- Remove any obstacle between the system and the device.
- Other devices that use the 2.4 GHz frequency band (wireless router, microwaves, cordless phones, etc.) are interfering. Move the device nearer to the system and distance it from the other devices.

HDMI

HDMI CEC related operations no longer function properly.

- Check the setting on the connected devices.
 - Switch on HDMI CEC function on the connected devices.
 - Select this system as the speaker in the TV’s HDMI CEC menu.
- When the HDMI connections are changed, after a power failure or after the AC mains lead has been removed, HDMI CEC operations may not function properly.
 - Switch on all the devices that are connected to the TV with an HDMI cable and then switch on the TV.
 - Switch off the HDMI CEC settings of the TV and switch it on again. For details refer to the operating instructions for the TV.
 - While the system and the TV are connected with an HDMI cable, switch on the TV, disconnect the AC mains lead of this system and then connect it again.

Sound

No sound

- Cancel muting. (⇒ 12)
- Check the connections to the other devices. (⇒ 9, 10)
- Make sure that the received audio signal is compatible with this system.
- If the system is connected to the TV with an HDMI cable only, make sure that the HDMI terminal of the TV is labelled “HDMI (ARC)”. If not, connect an optical digital audio cable. (⇒ 9, 10)
- Check the connections. Change the cables if the connections are correct.
- Check the audio output settings on the connected device.

The dual audio cannot be changed from main to secondary.

- If the audio received from the connected device is not “Dolby Dual Mono” or the output setting is not “Bitstream”, the setting cannot be changed from this system. Change the setting on the connected device.

The volume is lowered when the system is switched on.

- “Volume limitation” is on. (⇒ 13)
- If the system is switched off with the volume above 50, the volume will automatically set to 50 when you switch on the system. (⇒ 13)

The sound lags behind the image.

- Depending on the TV, when this system is connected to it via Bluetooth®, the sound output from this system may lag behind the TV image. Connect this system and the TV with an HDMI cable/optical digital audio cable. (⇒ 9, 10)

The audio format indicator does not correspond to the playback source.

- If the playback source is Dolby Digital or DTS®, set the audio output setting of the connected equipment (e.g., TV, player) to bitstream. For details, refer to the operating instructions for the connected equipment.

There is no audio.

The power of the main unit switches off automatically.

(When the main unit detects a problem, a safety measure is activated and the main unit automatically switches to standby mode.)

- There is a problem with the amplifier.
- Is the volume extremely high?
 - If so, lower the volume.
- Is this system placed in an extremely hot place?
 - If so, move this system to a cooler place and wait a few moments and then try to switch it on again.

If the problem persists, confirm the indicators status, switch off this system, disconnect the AC mains lead and consult your dealer. Please be sure to remember the indicators status and inform the dealer.

Active subwoofer

No power.

- Make sure the AC mains lead of the active subwoofer is connected.

After switching on the subwoofer, it immediately switches off.

- Disconnect the AC mains lead and consult your dealer.

No sound from the subwoofer.

- Check that the active subwoofer is switched on.
- Check that the WIRELESS LINK indicator lights up. (⇒ 11)

The WIRELESS LINK indicator does not lights up.

- There is no link between the main unit and the active subwoofer.
Check that the main unit is switched on.
- The active subwoofer and the main unit may not be paired correctly. Try the following operation.
(Wireless pairing)
 - ① Switch on the main unit.
 - ② Press and hold [I/D SET] on the rear of active subwoofer for a minimum of 4 seconds.
The wireless link indicator will blink.
 - ③ Press [MUTE], [SOUND]*, [MUTE]*, [PAIRING]* consecutively.
* Within 3 seconds.
“PAIRING”, “OPTICAL” and “HDMI (ARC)” indicators will blink in rotation.

When the wireless link pairing is successful, “PAIRING”, “OPTICAL” and “HDMI (ARC)” indicators will switch off.

Consult your dealer if the problem persists.

Remote control code

When other Panasonic equipment responds to the remote control of this system, change the remote control code for this system.

Preparation

- Switch off all other Panasonic products.
- Switch on this system.
- Aim the remote control at the remote control sensor of this system.

To set the code to code 2

Press and hold [PAIRING] and [SOUND] on the remote control for a minimum of 4 seconds.



To set the code to code 1

Press and hold [PAIRING] and [DIMMER] on the remote control for a minimum of 4 seconds.



System memory reset

Reset the memory when the following situations occur:

- There is no response when buttons are pressed.
- You want to clear and reset the memory contents.

Press and hold [ON] on the main unit for a minimum of 4 seconds.

All the indicators blink until the system restarts.

Note:

The remote control code will set back to code 1 after memory reset, refer to “Remote control code” on how to change to code 2.

Unit care

Disconnect the AC mains lead before maintenance. Clean this system with a soft, dry cloth.

- When dirt is heavy, wring a cloth moistened in water tightly to wipe the dirt, and then wipe it with a dry cloth.
- When cleaning the speakers, use a fine cloth. Do not use tissues or other materials (towels, etc.) that can fall apart. Small grains may get stuck inside the speaker cover.
- Never use alcohol, paint thinner or benzine to clean this system.
- Before using chemically treated cloth, read the instructions that came with the cloth carefully.

To dispose or transfer this system

This system may keep the user settings information in the main unit. If you discard the main unit either by disposal or transfer, then follow the procedure to return all the settings to the factory presets to delete the user settings.

(⇒ above)

- The operation history may be recorded in the memory of the main unit.



























Software update

Occasionally, Panasonic may release updated software for this unit that may add or improve the way a feature operates. These updates are available free of charge. For more details, refer to the following website.

<http://panasonic.jp/support/global/cs/>
(This site is in English only.)

Indicators illumination

The indicators show the condition of this system. The indicator patterns illustrated below are shown during normal operational conditions. They do not refer to the indications of a problem.

Indicators	Description
MUSIC CINEMA HDMI(ARC) OPTICAL   ● ● ● ●	The indicator blinks for 5 seconds. <ul style="list-style-type: none"> When the setting is on (“Auto power down”, “Bluetooth® standby”, “Volume limitation”) (⇒ 13) When the audio format is Dolby Digital. (⇒ 13) When the dual audio is main. (⇒ 12)
MUSIC CINEMA HDMI(ARC) OPTICAL  ●  ● ● ●	The indicator blinks for 5 seconds. <ul style="list-style-type: none"> When the audio format is DTS®. (⇒ 13)
MUSIC CINEMA HDMI(ARC) OPTICAL  ● ● ●  ● ●	The indicator blinks for 5 seconds. <ul style="list-style-type: none"> When the setting is off (“Auto power down”, “Bluetooth® standby”, “Volume limitation”) (⇒ 13) When the audio format is PCM. (⇒ 13) When the dual audio is secondary. (⇒ 12)
MUSIC CINEMA HDMI(ARC) OPTICAL  ● ● ● ●	The indicator blinks quickly. <ul style="list-style-type: none"> When the main unit is ready for pairing. (⇒ 11) The indicator blinks slowly. <ul style="list-style-type: none"> When the main unit is waiting to connect. (⇒ 11) The indicator lights on. <ul style="list-style-type: none"> When the main unit is connected to a Bluetooth® device. (⇒ 11)
MUSIC CINEMA HDMI(ARC) OPTICAL   ●  ● ● ●	The indicator blinks for 5 seconds. <ul style="list-style-type: none"> When the dual audio is main+secondary. (⇒ 12)
MUSIC CINEMA HDMI(ARC) OPTICAL  ●    	The indicator blinks for 10 seconds. <ul style="list-style-type: none"> When the remote control is set to code 2. (⇒ 16)
MUSIC CINEMA HDMI(ARC) OPTICAL   ●   	The indicator blinks for 10 seconds. <ul style="list-style-type: none"> When the remote control is set to code 1. (⇒ 16)
MUSIC CINEMA HDMI(ARC) OPTICAL      	The indicators blink until the system restarts. <ul style="list-style-type: none"> When the main unit is reset. (⇒ 16) The indicators blink continuously. <ul style="list-style-type: none"> When the sound is muted. (⇒ 12) The indicators blink 10 times. <ul style="list-style-type: none"> When active subwoofer is failed to connect. (⇒ 16)

Specifications

Amplifier section

HTB258 **HTB250**

RMS output power: Dolby Digital Mode

Front ch	40 W per channel (6 Ω), 1 kHz, 10% THD
Subwoofer ch	40 W per channel (4 Ω), 100 Hz, 10% THD
Total RMS Dolby Digital mode power	120 W

HTB208 **HTB200**

RMS output power stereo mode (both ch driven)

Front ch	40 W per channel (6 Ω), 1 kHz, 10% THD
Total RMS Stereo mode power	80 W

Terminals section

HDMI output (ARC)

Output connector	Type A (19 pin)
------------------	-----------------

Digital audio input

Optical digital input	Optical terminal
Sampling frequency	32 kHz, 44.1 kHz, 48 kHz
Audio format	LPCM, Dolby Digital, DTS Digital Surround™

USB Port	For software update
-----------------	---------------------

Bluetooth® section

Version	Bluetooth® Ver. 2.1 + EDR
Class	Class 2
Supported profiles	A2DP
Operating frequency	2.4 GHz band FH-SS
Frequency band	2402 MHz to 2480 MHz
Operation distance	10 m line of sight
Maximum RF Power	4 dBm
Supported codec	SBC

Speaker section

Front speakers (Built-in)

Full range	4 x 10 cm (Cone type) x 1/ch
------------	------------------------------

Active subwoofer **HTB258** **HTB250**

Woofer	14 cm cone type x 1
--------	---------------------

Wireless section

Wireless module

Frequency range	2404 MHz to 2476 MHz
No. of channels	38
RF output power	7 dBm (max.)

General

Power supply	AC 220 V to 240 V, 50 Hz
---------------------	--------------------------

Power consumption

Main unit	15 W
Active subwoofer HTB258 HTB250	7.5 W

Dimensions (W x H x D)

Main unit	450 mm x 51 mm x 135 mm
Active subwoofer HTB258 HTB250	97 mm x 451 mm x 307 mm

Mass

Main unit	1.6 kg
Active subwoofer HTB258 HTB250	4.4 kg

Operating temperature range	0°C to +40°C
------------------------------------	--------------

Operating humidity range	20% to 80% RH (no condensation)
---------------------------------	---------------------------------

Power consumption in standby mode (approximate)

Main unit	
When Bluetooth® standby is off	0.5 W
When Bluetooth® standby is on	2.0 W
Active subwoofer HTB258 HTB250	0.5 W
When wireless activated in network standby	2.0 W

Note:

- Specifications are subject to change without notice. Mass and dimensions are approximate.
- Total harmonic distortion is measured by the digital spectrum analyser.

Disposal of Old Equipment and Batteries Only for European Union and countries with recycling systems



These symbols on the products, packaging, and/or accompanying documents mean that used electrical and electronic products and batteries must not be mixed with general household waste.

For proper treatment, recovery and recycling of old products and used batteries, please take them to applicable collection points in accordance with your national legislation.

By disposing of them correctly, you will help to save valuable resources and prevent any potential negative effects on human health and the environment. For more information about collection and recycling, please contact your local municipality.

Penalties may be applicable for incorrect disposal of this waste, in accordance with national legislation.



Note for the battery symbol (bottom symbol):

This symbol might be used in combination with a chemical symbol. In this case it complies with the requirement set by the Directive for the chemical involved.



English

Declaration of Conformity (DoC)

Hereby, "Panasonic Corporation" declares that this product is in compliance with the essential requirements and other relevant provisions of Directive 2014/53/EU.

Customers can download a copy of the original DoC to our RE products from our DoC Server:

<http://www.ptc.panasonic.eu>

Contact to Authorised Representative:

Panasonic Marketing Europe GmbH, Panasonic Testing Centre, Winsbergring 15, 22525 Hamburg, Germany

Type of wireless	Frequency band	Maximum power (dBm E.I.R.P.)
Bluetooth®	2402 – 2480 MHz	4 dBm
2.4 GHz wireless system	2404 – 2476 MHz	7 dBm

Ελληνικά

Δήλωση συμμόρφωσης (DoC)

Η "Panasonic Corporation" δηλώνει ότι το προϊόν αυτό είναι συμμορφωμένο προς τις βασικές απαιτήσεις και άλλες σχετικές διατάξεις της Οδηγίας 2014/53/ΕΕ.

Οι πελάτες μπορούν να κατεβάσουν ένα αντίγραφο του πρωτοτύπου DoC για τα RE προϊόντα μας από τον DoC server μας:

<http://www.ptc.panasonic.eu>

Επικοινωνήστε με τον Εξουσιοδοτημένο Αντιπροσωπώ μας:

Panasonic Marketing Europe GmbH, Panasonic Testing Centre, Winsbergring 15, 22525 Hamburg, Γερμανία

Τύπο ασύρματης	Ζώνη συχνοτήτων	Μέγιστη ισχύς (dBm e.i.r.p.)
Bluetooth®	2402 – 2480 MHz	4 dBm
2.4 GHz wireless system	2404 – 2476 MHz	7 dBm

Português

Declaração de Conformidade (DoC)

Com o presente documento, a "Panasonic Corporation" declara que este produto se encontra em conformidade com os requisitos específicos e demais especificações referentes à Diretiva 2014/53/UE.

Os clientes podem baixar uma cópia da declaração de conformidade (DoC) para nossos produtos RE do Server DoC:

<http://www.ptc.panasonic.eu>

Contacto com um Representante Autorizado:

Panasonic Marketing Europe GmbH, Panasonic Testing Centre, Winsbergring 15, 22525 Hamburg, Alemanha

Tipo de ligação sem fios	Banda de frequência	Potência máxima (dBm e.i.r.p.)
Bluetooth®	2402 – 2480 MHz	4 dBm
2.4 GHz wireless system	2404 – 2476 MHz	7 dBm

Lietuviškai

Atitikties deklaracija (AD)

Bendrovė "Panasonic Corporation" patvirtina, kad šis gaminytis atitinka direktyvos 2014/53/ES esminius reikalavimus ir kitas taikytinas nuostatas.

Mūsų RE gaminių originalios atitikties deklaracijos kopija klientai gali atsisiųsti iš mūsų AD serverio:

<http://www.ptc.panasonic.eu>

Igaliojoto atstovo adresas:

Panasonic Marketing Europe GmbH, Panasonic Testing Centre, Winsbergring 15, 22525 Hamburg, Vokietija

Beviolio ryšio tinklas	Dažnių diapazonas	Maksimali siuntimo galia (dBm e.i.r.p.)
Bluetooth®	2402 – 2480 MHz	4 dBm
2.4 GHz wireless system	2404 – 2476 MHz	7 dBm

Slovensko

Izjava o skladnosti (DoC)

"Panasonic Corporation" v tem dokumentu izjavlja, da je izdelek v skladu z bistvenimi zahtevami in drugimi pomembnimi določbami Direktive 2014/53/EU.

Stranka lahko naloži izvod izvirnega DoC o naših izdelkih RE s strežnika DoC:

<http://www.ptc.panasonic.eu>

Naslov pooblaščenega predstavnika:

Panasonic Marketing Europe GmbH, Panasonic Testing Centre, Winsbergring 15, 22525 Hamburg, Nemčija

Vrsta brezžične povezave	Frekvenčni pas	Največja moč (dBm EIRP)
Bluetooth®	2402 – 2480 MHz	4 dBm
2.4 GHz wireless system	2404 – 2476 MHz	7 dBm

Slovensky

Vyhlasenie o zhode (DoC)

"Panasonic Corporation" týmto vyhlasuje, že tento výrobok je v súlade so základnými požiadavkami a ďalšími príslušnými ustanoveniami smernice 2014/53/EÚ.

Zákazníci si môžu stiahnuť kópiu pôvodného DoC na naše RE výrobky z nášho servera DoC:

<http://www.ptc.panasonic.eu>

Kontakt na splnomocneného zástupcu:

Panasonic Marketing Europe GmbH, Panasonic Testing Centre, Winsbergring 15, 22525 Hamburg, Nemecko

Typ bezdrôtového pripojenia	Frekvenčné pásmo	Maximálny výkon (dBm e.i.r.p.)
Bluetooth®	2402 – 2480 MHz	4 dBm
2.4 GHz wireless system	2404 – 2476 MHz	7 dBm

Norsk

Samsvarserklæring (DoC)

"Panasonic Corporation" erklærer herved at dette produktet samsvarer med de grunnleggende kravene og andre relevante bestemmelser i direktivet 2014/53/EU. Kundene kan laste ned en kopi av den originale samsvarserklæringen (DoC) for vårt RE utstyr fra vår DoC server:

<http://www.ptc.panasonic.eu>

Kontaktinformasjon autorisert representant:

Panasonic Marketing Europe GmbH, Panasonic Testing Centre, Winsbergring 15, 22525 Hamburg, Tyskland

Type trådløs	Frekvensbånd	Maks. effekt (dBm e.i.r.p.)
Bluetooth®	2402 – 2480 MHz	4 dBm
2.4 GHz wireless system	2404 – 2476 MHz	7 dBm

Latviski

Atbilstības deklarācija (DoC)

Ar šo "Panasonic Corporation" paziņo, ka šis izstrādājums atbilst pamatprasībām un pārējiem Direktīvas 2014/53/ES noteikumiem.

Pircēji var lejupielādēt oriģinālo DoC kopiju mūsu RE izstrādājumos no mūsu DoC servera:

<http://www.ptc.panasonic.eu>

Lūdzam sazināties ar pilnvaroto parstāvi:

Panasonic Marketing Europe GmbH, Panasonic Testing Centre, Winsbergring 15, 22525 Hamburg, Vācijā

Bezvadu tips	Frekvenču josla	Maksimālā jauda (dBm EIRP)
Bluetooth®	2402 – 2480 MHz	4 dBm
2.4 GHz wireless system	2404 – 2476 MHz	7 dBm

Eesti keel

Vastavusdeklaratsioon (DoC)

Käesolevaga kinnitab "Panasonic Corporation", et see toode vastab direktiivi 2014/53/EL olulistele nõuetele ja teistele asjakohastele sätetele.

Kliendid saavad koopia meie RE toodetele kehtiva originaalvastavusdeklaratsiooni koopia alla laadida meie DoC-serverist:

<http://www.ptc.panasonic.eu>

Võtke ühendust volitatud esindajaga:

Panasonic Marketing Europe GmbH, Panasonic Testing Centre, Winsbergring 15, 22525 Hamburg, Saksamaa

Juhtmevaba seadme tüüp	Sagedusriba	Maksimaalne võimsus (dBm EIRP)
Bluetooth®	2402 – 2480 MHz	4 dBm
2.4 GHz wireless system	2404 – 2476 MHz	7 dBm

Български

Декларация за съответствие (DoC)

С настоящото "Panasonic Corporation" декларира, че този продукт е в съответствие с основните изисквания и други съответни разпоредби на Директива 2014/53/EC.

Потребителите могат да свалят копие от оригиналните DoC към нашите продуктите от типа RE от сървъра, на който се съхраняват DoC:

<http://www.ptc.panasonic.eu>

Свържете се с нашия упълномощен представител:

Panasonic Marketing Europe GmbH, Panasonic Testing Centre, Winsbergring 15, 22525 Hamburg, Германия

Вид безжична връзка	Честотна лента	Максимална мощност (dBm e.i.r.p.)
Bluetooth®	2402 – 2480 MHz	4 dBm
2.4 GHz wireless system	2404 – 2476 MHz	7 dBm

Román

Declarație de Conformitate (DoC)

"Panasonic Corporation" declară prin prezenta că acest produs este conform cu cerințele esențiale și alte prevederi relevante ale Directivei 2014/53/UE.

Clienții pot descărca o copie a DoC-ului original al produselor noastre RE de la adresa noastră DoC din Internet:

<http://www.ptc.panasonic.eu>

Contactați Reprezentantul Autorizat:

Panasonic Marketing Europe GmbH, Panasonic Testing Centre, Winsbergring 15, 22525 Hamburg, Germania

Tip de wireless	Interval de frecvență	Putere maximă (dBm e.i.r.p.)
Bluetooth®	2402 – 2480 MHz	4 dBm
2.4 GHz wireless system	2404 – 2476 MHz	7 dBm

Magyar

Megfelelőségi Nyilatkozat (DoC)

Ezennel a "Panasonic Corporation" kijelenti, hogy a jelen termék kielégíti az 2014/53/EU Irányelv létfontosságú követelményeit és más vonatkozó rendelkezéseit.

A vásárlók letölthetik az RE termékek eredeti DoC

másolatát a DoC szerverünkről:

<http://www.ptc.panasonic.eu>

A hivatalos képviselő elérhetősége:

Panasonic Marketing Europe GmbH, Panasonic Testing Centre, Winsbergring 15, 22525 Hamburg, Németország

Wireless típus	Frekvenciasáv	Maximális teljesítmény (dBm e.i.r.p.)
Bluetooth®	2402 – 2480 MHz	4 dBm
2.4 GHz wireless system	2404 – 2476 MHz	7 dBm

Hrvatski

Deklaracija o podobnosti (DoC)

Ovime "Panasonic Corporation" izjavljuje da ovaj proizvod udovoljava osnovnim zahtjevima i ostalim relevantnim odredbama Direktive 2014/53/EU.

Kupci mogu preuzeti kopiju originalne DoC za naše RE proizvode s našeg DoC poslužitelja:
<http://www.ptc.panasonic.eu>

Adresa ovlaštenog predstavništva:

Panasonic Marketing Europe GmbH, Panasonic Testing Centre, Winsbergring 15, 22525 Hamburg, Njemačka

Vrsta bežične mreže	Frekvencijski pojas	Maksimalna snaga (dBm e.i.r.p.)
Bluetooth®	2402 – 2480 MHz	4 dBm
2.4 GHz wireless system	2404 – 2476 MHz	7 dBm

Türkçe

Uygunluk Beyanı (DoC)

"Panasonic Corporation" bu belge ile bu ürünün 2014/53/EU Direkti'nin temel gerekliliklerine ve diğer ilgili hükümlerine uygun olduğunu beyan eder.

Müşterilerimiz RE ürünlerimizle ilgili orijinal DoC belgesinin bir kopyasını DoC sunucumuzdan indirebilir:
<http://www.ptc.panasonic.eu>

Yetkili Temsilci ile temasa geçin:

Panasonic Marketing Europe GmbH, Panasonic Testing Centre, Winsbergring 15, 22525 Hamburg, Almanya

Kablosuz türü	Frekans bandı	Maksimum güç (dBm e.i.r.p.)
Bluetooth®	2402 – 2480 MHz	4 dBm
2.4 GHz wireless system	2404 – 2476 MHz	7 dBm

Limited Warranty (For Australia only)

Panasonic Warranty

1. The product is warranted for 12 months from the date of purchase. Subject to the conditions of this warranty Panasonic or its Authorised Service Centre will perform necessary service on the product without charge for parts or labour, if in the opinion of Panasonic, the product is found to be faulty within the warranty period.
2. This warranty only applies to Panasonic products purchased in Australia and sold by Panasonic Australia or its Authorised Distributors or Dealers and only where the products are used and serviced within Australia or its territories. Warranty cover only applies to service carried out by a Panasonic Authorised Service Centre and only if valid proof of purchase is presented when warranty service is requested.
3. This warranty only applies if the product has been installed and used in accordance with the manufacturer's recommendations (as noted in the operating instructions) under normal use and reasonable care (in the opinion of Panasonic). The warranty covers normal domestic use only and does not cover damage, malfunction or failure resulting from use of incorrect voltages, incorrect installation, accident, misuse, neglect, build-up of dirt or dust, abuse, maladjustment of customer controls, mains supply problems, thunderstorm activity, infestation by insects or vermin, tampering or repair by unauthorised persons (including unauthorised alterations), introduction of sand, humidity or liquids, commercial use such as hotel, office, restaurant, or other business or rental use of the product, exposure to abnormally corrosive conditions or any foreign object or matter having entered the product.
4. This warranty does not cover the following items unless the fault or defect existed at the time of purchase:
 - (a) Cabinet Part(s)
 - (b) Video or Audio Tapes
 - (c) SD cards or USB devices
 - (d) User replaceable Batteries
 - (e) DVD, Blu-ray or Recordable Discs
 - (f) Video / Audio Heads from wear and tear in normal use
 - (g) Information stored on Hard Disk Drive, USB stick or SD card
 - (h) DTV reception issues caused by TV Aerial / Cabling / Wall socket(s) etc
5. Some products may be supplied with Ethernet connection hardware. The warranty is limited on such products and will not cover
 - (a) Internet and or DLNA connection / setup related problems
 - (b) Access fees and or charges incurred for internet connection
 - (c) The use of incompatible software or software not specifically stipulated in the product operations manual; and
 - (d) Any indirect or consequential costs associated with the incorrect use or misuse of the hardware, its connection to the internet or any other device.
6. To claim warranty service, when required, you should:
 - Telephone Panasonic's Customer Care Centre on 132600 or visit our website referred to below and use the Service Centre Locator for the name / address of the nearest Authorised Service Centre.
 - Send or take the product to a Panasonic Authorised Service Centre together with your proof of purchase receipt as a proof of purchase date. Please note that freight and insurance to and / or from your nearest Authorised Service Centre must be arranged by you.
 - Note that home or pick-up / delivery service is available for the following products in the major metropolitan areas of Australia or the normal operating areas of the nearest Authorised Service Centres:
 - Plasma / LCD televisions / displays (screen size greater than 103 cm)
7. The warranties hereby conferred do not extend to, and exclude, any costs associated with the installation, de-installation or re-installation of a product, including costs related to the mounting, de-mounting or remounting of any screen, (and any other ancillary activities), delivery, handling, freighting, transportation or insurance of the product or any part thereof or replacement of and do not extend to, and exclude, any damage or loss occurring by reason of, during, associated with, or related to such installation, de-installation, re-installation or transit.

Panasonic Authorised Service Centres are located in major metropolitan areas and most regional centres of Australia, however, coverage will vary dependant on product. For advice on exact Authorised Service Centre locations for your product, please telephone our Customer Care Centre on 132600 or visit our website and use the Service Centre Locator.

In addition to your rights under this warranty, Panasonic products come with consumer guarantees that cannot be excluded under the Australian Consumer Law. If there is a major failure with the product, you can reject the product and elect to have a refund or to have the product replaced or if you wish you may elect to keep the goods and be compensated for the drop in value of the goods. You are also entitled to have the product repaired or replaced if the product fails to be of acceptable quality and the failure does not amount to a major failure.

If there is a major failure in regard to the product which cannot be remedied then you must notify us within a reasonable period by contacting the Panasonic Customer Care Centre. If the failure in the product is not a major failure then Panasonic may choose to repair or replace the product and will do so in a reasonable period of time from receiving notice from you.

**THIS WARRANTY CARD AND THE PURCHASE DOCKET (OR SIMILAR PROOF OF PURCHASE)
SHOULD BE RETAINED BY THE CUSTOMER AT ALL TIMES**

If you require assistance regarding warranty conditions or any other enquiries, please visit the **Panasonic Australia** website www.panasonic.com.au or contact by phone on **132 600**
If phoning in, please ensure you have your operating instructions available.

Panasonic Australia Pty. Limited

ACN 001 592 187 ABN 83 001 592 187
1 Innovation Road, Macquarie Park NSW 2113

ADVARSEL!**Produkt**

- For å redusere faren for brann, elektrisk støt eller skade på apparatet:
 - Dette apparatet må ikke utsettes for regn, fuktighet, drypp eller sprut.
 - Ikke plasser objekter som er fylt med væske, som vaser, på apparatet.
 - Bruk anbefalt tilbehør.
 - Fjern ikke deksler.
 - Dette apparatet må ikke repareres på egen hånd. Overlat servicearbeider til kvalifisert servicepersonell.

FORSIKTIG!**Produkt**

- For å redusere faren for brann, elektrisk støt eller skade på apparatet:
 - Ikke plasser apparatet i en bokhylle, et innebygget kabinett eller et annet lukket sted. Pass på at apparatet er godt ventilert.
 - Apparatets ventilasjonsåpninger må ikke dekkes til med aviser, duker, gardiner eller lignende.
 - Plasser ikke åpen ild, slik som levende lys, oppå apparatet.
- Dette apparatet er beregnet til bruk under moderate klimaforhold.

Vekselstrømnett

- Støpselet er frakoblende enhet. Strømuttaket må befinne seg i nærheten slik at støpselet lett kan kobles ut fra uttaket umiddelbart.



Manufactured by: Panasonic Corporation
Kadoma, Osaka, Japan

Importer for Europe: Panasonic Marketing Europe GmbH
Panasonic Testing Centre
Winsbergring 15, 22525 Hamburg, Germany



Panasonic Corporation
Web Site: <http://www.panasonic.com>

En

TQBJ2086
L1217CH0