

Model No.

TH-43LX800Z

TH-50LX800Z

TH-55LX800Z

TH-65LX800Z

TH-75LX800Z

Operating Instructions LED TV

43-inch model



50-inch model

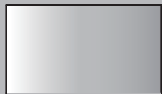

55-inch model



65-inch model



75-inch model



English

Thank you for purchasing this Panasonic product. Please read these instructions carefully before operating this product and retain them for future reference.

The images shown in this manual are for illustrative purposes only.

Some illustrations are presented as conceptual images and may be different from the actual products.

Illustrations shown may be different between models and countries.

The illustrations for 50-inch model is used in this manual unless otherwise mentioned.

Transport only in upright position



The Adopted Trademarks HDMI, HDMI High-Definition Multimedia Interface, and the HDMI Logo are trademarks or registered trademarks of HDMI Licensing Administrator, Inc. in the United States and other countries.



Dolby, Dolby Vision, Dolby Atmos, and the double-D symbol are trademarks of Dolby Laboratories Licensing Corporation. Manufactured under license from Dolby Laboratories. Confidential unpublished works. Copyright 1992–2022 Dolby Laboratories. All rights reserved.

Important Notice

Panasonic does not guarantee operation and performance of peripheral devices made by other manufacturers; and we disclaim any liability or damage arising from operation and/or performance from usage of such other maker's peripheral devices.

Handling of customer information

Panasonic has no authority to and does not grant you that permission and explicitly disclaims any right, ability or intention to obtain such permission on your behalf. It is your responsibility to ensure that your use of this or any other device complies with applicable copyright legislation in your country. Please refer to that legislation for more information on the relevant laws and regulations involved or contact the owner of the rights in the content you wish to record or playback.

This product is licensed under the AVC patent portfolio license for the personal and non-commercial use of a consumer to (i) encode video in compliance with the AVC Standard ("AVC Video") and/or (ii) decode AVC Video that was encoded by a consumer engaged in a personal and non-commercial activity and/or was obtained from a video provider licensed to provide AVC Video. No license is granted or shall be implied for any other use.

Additional information may be obtained from MPEG LA, LLC.

See <http://www.mpegla.com>.

Panasonic and its affiliates make no representations or warranties of any kind with respect to the USB devices and the performance of communication between the USB devices and the USB port of Panasonic products, and expressly disclaims any and all warranties, whether express or implied or otherwise, including without limitation any implied warranty of fitness for a particular purpose, any loss of data, and any implied warranties arising from course of dealing or course of performance of data communication between the USB devices and the USB port of Panasonic products.

Transport only in upright position.



This mark indicates the product operates on AC voltage.



This mark indicates a Class II or double insulated electrical appliance wherein the product does not require a safety connection to electrical earth (ground).

Contents

Safety Precautions	3
Setting Up the TV	4
Connecting the TV	6
Initial Setup	8
Operating the TV	10
Watching External Inputs	13
Using Homepage-Apps	13
Using the Menu Functions	14
Using Media Player	17
Additional Information	18
Troubleshooting	20
Maintenance	20
Specifications	21

Safety Precautions

To help avoid risk of electrical shock, fire, damage or injury, please follow the warnings and cautions below:

Mains plug and lead

Warning

If you detect anything unusual, immediately remove the mains plug.

- Mains plug types vary between countries.

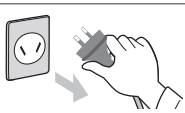

- This TV is designed to operate on AC 100 - 240 V, 50/60 Hz.
- Insert the mains plug fully into the socket outlet.
- Ensure that the mains plug is easily accessible.
- Disconnect the mains plug when cleaning the TV.
- Do not touch the mains plug with wet hands.



- Do not damage the mains lead.
 - Do not place a heavy object on the lead.



- Do not place the lead near a high temperature object.



- Do not pull on the lead. Hold onto the mains plug body when disconnecting the plug.



- Do not move the TV with the lead plugged into a socket outlet.
- Do not twist the lead, bend it excessively or stretch it.
- Do not use a damaged mains plug or socket outlet.
- Ensure the TV does not crush the mains lead.
- Do not use any mains lead other than that provided with this TV.

Take care

Warning

- Do not remove covers and never modify the TV yourself as live parts are accessible when they are removed. There are no user serviceable parts inside.
- Do not expose the TV to rain or excessive moisture. This TV must not be exposed to dripping or splashing water and objects filled with liquid, such as vases, must not be placed on top of or above the TV.



- Do not insert foreign objects into the TV through the air vents.
- Do not use an unapproved pedestal / mounting equipment. Be sure to ask your local Panasonic dealer to perform the setup or installation of approved wall-hanging brackets.
- Do not apply strong force or impact to the display panel.
- Do not place the TV on sloped or unstable surfaces, and ensure that the TV does not hang over the edge of the base.



- This TV is designed for table-top use.
- Do not expose the TV to direct sunlight and other sources of heat.



To prevent the spread of fire, keep candles or other open flames away from this product at all times



Dangerous part / Small object

Warning

- This product contains possibly dangerous parts such as plastic bags, that can be breathed in or swallowed by young children accidentally. Keep these parts out of reach of young children.

Pedestal

Warning

- Do not disassemble or modify the pedestal.

Caution

- Do not use any pedestal other than the one provided with this TV.
- Do not use the pedestal if it becomes warped or physically damaged. If this occurs, contact your nearest Panasonic dealer immediately.
- During setup, make sure that all screws are securely tightened.
- Ensure that the TV does not suffer any impact during installation of the pedestal.
- Ensure that children do not climb onto the pedestal.
- Install or remove the TV from the pedestal with at least two people.
- Install or remove the TV by the specified procedure.

Ventilation

Caution

Allow sufficient space around the TV in order to help prevent excessive heat, which could lead to early failure of some electronic components.

Minimum distance (cm)

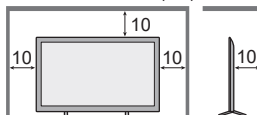

- Ventilation should not be impeded by covering the ventilation openings with items such as newspapers, tablecloths and curtains.



- Whether you are using a pedestal or not, always ensure the vents at the bottom of the TV are not blocked and there is sufficient space to enable adequate ventilation.

Built-in wireless LAN

Caution

- Do not use the built-in wireless LAN to connect to any wireless network (SSID*) for which you do not have usage rights. Such networks may be listed as a result of searches. However, using them may be regarded as illegal access.
 - *SSID is a name for identifying a particular wireless network for transmission.
- Do not subject the built-in wireless LAN to high temperatures, direct sunlight or moisture.
- Data transmitted and received over radio waves may be intercepted and monitored.
- The built-in wireless LAN uses 2.4 GHz and 5 GHz frequency bands. To avoid malfunctions or slow response caused by radio wave interference when using the built-in wireless LAN, keep the TV away from other devices that use 2.4 GHz and 5 GHz signals such as other wireless LAN devices, microwave ovens, and mobile phones.
- When problems occur due to static electricity, etc., the TV might stop operating to protect itself. In this case, turn the TV off at the Mains power On / Off switch, then turn it back on.

Bluetooth® wireless technology

Caution

- The TV use the 2.4 GHz radio frequency ISM band (Bluetooth®). To avoid malfunctions or slow response caused by radio wave interference, keep the TV away from the devices such as other wireless LAN devices, other Bluetooth devices, microwaves, mobile phones and the devices that use 2.4 GHz signal.

Moving the TV

Caution

Before moving the TV, disconnect all cables.

- Move the TV with at least two people. Support as shown to avoid injury by the TV tipping or falling.

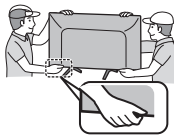

When not in use for a long time

Caution

This TV will still consume some power even in the Off mode, as long as the mains plug is still connected to a live socket outlet.

- Remove the mains plug from the wall socket when the TV is not in use for a prolonged period of time.

Battery for the Remote Control

Caution

- Incorrect installation may cause battery leakage, corrosion and explosion.
- Replace only with the same or equivalent type.
- Do not mix old and new batteries.
- Do not mix different battery types (such as alkaline and manganese batteries).
- Do not use rechargeable batteries (Ni-Cd, etc.).
- Do not burn or break up batteries.
- Do not expose batteries to excessive heat such as sunshine, fire or the like.
- Make sure you dispose of batteries correctly.

Prevention of Dumping

Caution

- Please use the screw in the wall-mount hole of the back cover with the restraining bracket and rope to make sure that it is firmly tied and fixed on the table and other solid position.

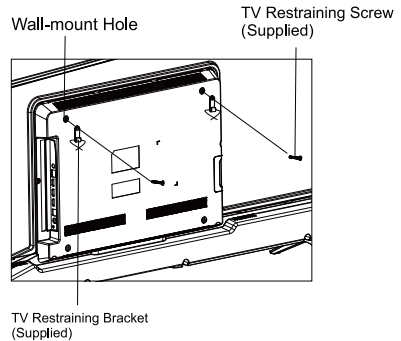

*This images shown for illustration only.

Setting Up the TV

Supplied accessories

Accessories may not be placed all together. Take care not to throw them away unintentionally.

Operating Instructions

Remote Control

- RC700P or RC730P



Batteries (AAA) × 2

➔(p.5)



Mains Lead

➔(p.8)

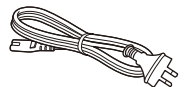

Mini Jack Adapter

- Adapter AV



Pedestal

43-inch model

- Base

- Assembly screws
(M4 × 19) × 4



50-inch model

- Base

- Assembly screws
(M5 × 20) × 4



55-inch model

- Base

- Assembly screws
(M5 × 20) × 4



65-inch model

- Base

- Assembly screws
(M5 × 27) × 4



75-inch model

- Base

- Assembly screws
(M6 × 33) × 4



Anti-falling accessories

Bracket x 2
Rope x 2

Note

Illustrations shown may be different between models and countries.

Preparation

Take out the pedestal and the TV from the packing case and put the TV onto a work table with the screen panel down on the clean and soft cloth (blanket, etc.)

- Use a flat and firm table bigger than the TV.
- Do not hold the screen panel part.
- Make sure not to scratch or break the TV.

Attaching the pedestal

1 Assemble the pedestal

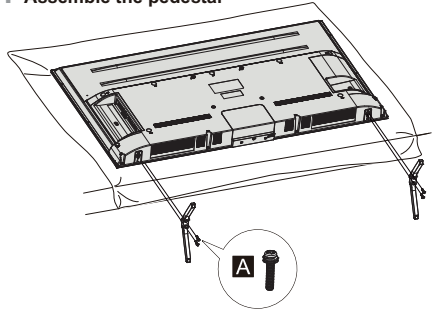

Removing the pedestal from the TV

Be sure to remove the pedestal in the following way when using the wall-hanging bracket or repacking the TV.

- 1 Lay the TV on a foam mat or thick soft cloth on a table.
- 2 Remove the assembly screws **A** from the TV.

Inserting remote's batteries

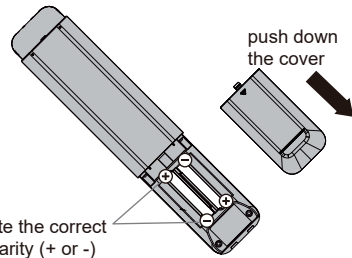

Note the correct polarity (+ or -)

Wall mounting the TV (optional)

Please contact your local Panasonic dealer to purchase the recommended wall-hanging bracket.

Rear of the TV

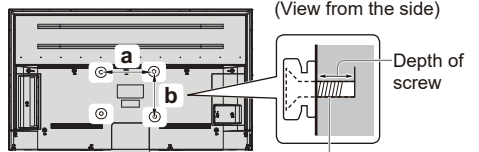

Screw for fixing the TV onto the wall-hanging bracket (not supplied)

Holes for wall-hanging bracket installation

Model	a	b
43-inch	200 mm	200 mm
50-inch	200 mm	200 mm
55-inch	400 mm	300 mm
65-inch	400 mm	300 mm
75-inch	400 mm	300 mm

Screw specification

Model	Type	Depth of screw	
		Minimum	Maximum
43-inch	M6	10 mm	12 mm
50-inch	M6	12 mm	15 mm
55-inch	M6	12 mm	15 mm
65-inch	M6	12 mm	15 mm
75-inch	M6	12 mm	15 mm

Warning

- When optional accessories such as wall brackets etc. are used, always read and follow the manufacturer installation and usage instructions.
- Do not mount the unit directly below ceiling lights (such as spotlights or halogen lights) which typically give off high heat. Doing so may warp or damage plastic cabinet parts.
- When installing wall brackets you must ensure the wall bracket is not electrically grounded to metal wall studs. Always ensure that there are no electrical cables, pipes etc. in the wall before you begin the wall bracket installation.
- To prevent fall and injury, remove the TV from its fixed wall position when it is no longer in use.

Connecting the TV

- Please ensure the TV is disconnected from the mains socket/ power point before attaching or disconnecting any RF/ AV leads.
- External equipment and cables are for illustrative purposes only and not supplied with this TV.
- Check the type of terminals and cable plugs are correct when connecting.
- When using an HDMI cable, use the fully wired one.
- Keep the TV away from electronic equipment (video equipment, etc.) or equipment with an infrared sensor. Otherwise, distortion of image/ sound may occur or operation of other equipment may be interfered.
- Also read the manual of the equipment being connected.

Terminals

Rear of the TV

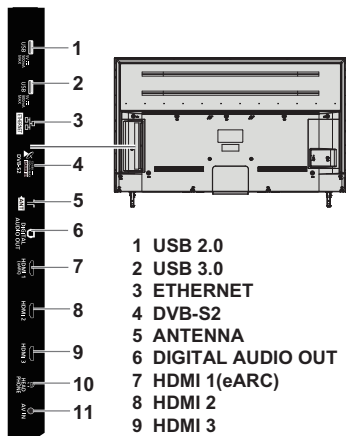

- 1 USB 2.0
- 2 USB 3.0
- 3 ETHERNET
- 4 DVB-S2
- 5 ANTENNA
- 6 DIGITAL AUDIO OUT
- 7 HDMI 1(eARC)
- 8 HDMI 2
- 9 HDMI 3
- 10 HEADPHONE
- 11 AV IN

Connections

Aerial

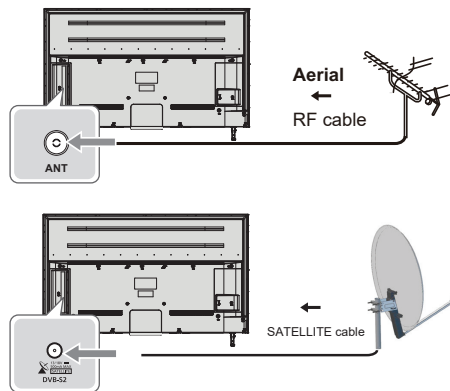

This TV has a satellite tuner, for receiving free satellite channels without the need for an external satellite set-top box or a dedicated remote control for watching by satellite.

- Keep RF (aerial) cable away from the mains lead to avoid and minimise mains interference pickup.
- Do not place the RF cable under the TV.
- An aerial, correct cable (75 Ω coaxial) and correct terminating plug are required to obtain optimum quality picture and sound.
- If a communal aerial system is used, you may require the correct connection cable and plug between the wall aerial socket and the TV.

- Your local Television Service Centre or dealer may be able to assist you in obtaining the correct aerial system for your particular area and the accessories required.
- Any matters regarding aerial installation, upgrading of existing systems or accessories required, and the costs incurred, are the responsibility of you, the customer.
- If the aerial is placed in the wrong location, interference might happen.

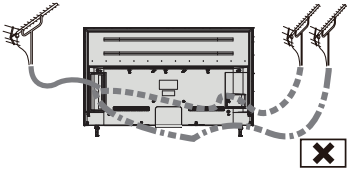
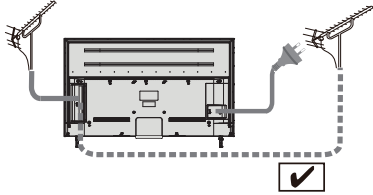

Blu-Ray Player

TV

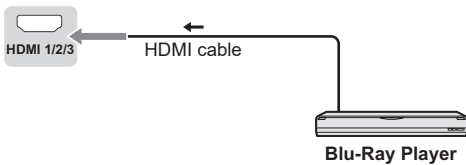

AV / Game equipment

Using HDMI terminal

TV

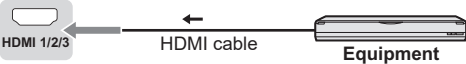

Using AV terminals

TV



DVD Recorder / VCR

TV

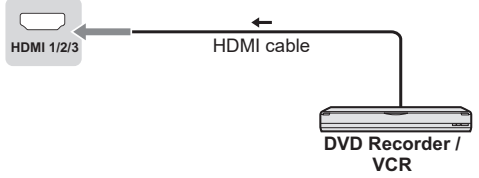

Set top box

TV

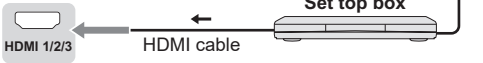

Speaker system

TV

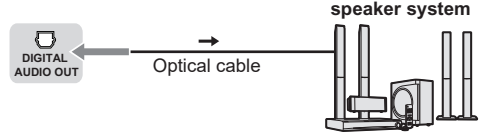

- To enjoy the sound from the external equipment in multi-channel sound (e.g. Dolby Digital 5.1ch), connect the equipment to the amplifier. For the connections, read the manuals of the equipment and amplifier.

Amplifier

TV

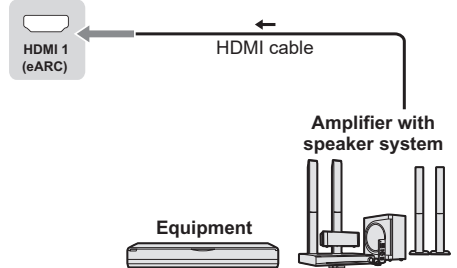

- Use HDMI1 to connect the TV to an amplifier which has eARC/ARC(Audio Return Channel) function. If connecting to an amplifier without eARC/ARC function, use DIGITAL AUDIO OUT.

Initial Setup

When you first turn on the TV, a series of steps will pop-up to guide you to setup your TV.

- These steps are not necessary if the setup has been completed by your local dealer.

1 Plug the mains plug into the socket outlet and turn on the TV.

It may take a few seconds before the screen is displayed.

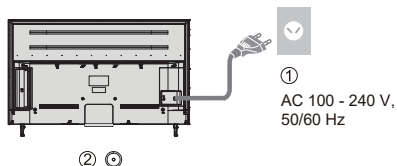

Note: If you don't want to use your Android device to setup the TV, you will skip to Step 3. If you want to use your Android device to setup the TV, please turn on the Bluetooth functions of your Android phone, then find and open "Google" application on your phone. Follow the instruction tips to set device.

Step 3: Select whether or not to connect your TV set to the Wi-Fi network.

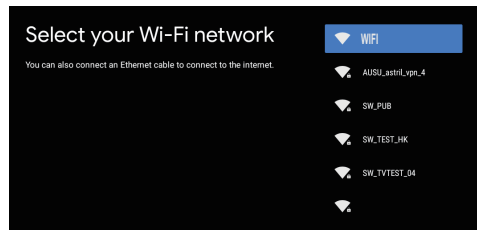

Note: If you have connected the TV to the Wi-Fi network, it will check for updates like Google service updates and so on. Then please select whether or not to sign in to your Google account.

Step 4: Sign in to get new apps, recommendations, movies, the Assistant, and more from Google.

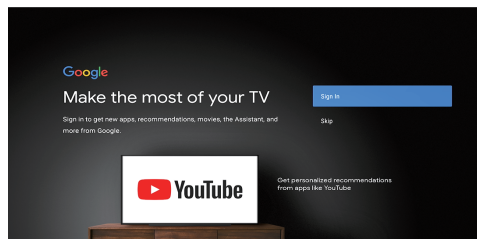

Step 5: Read to accept the Google terms of service and privacy policy.

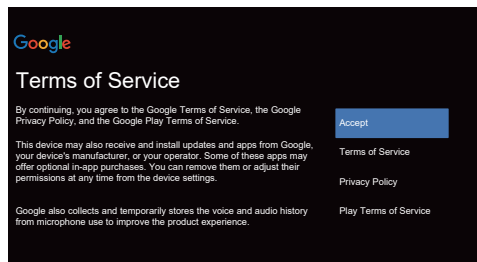

Google - Initial Setup

When you turn on the TV for the first time, there will show a wizard to guide you to finish the following initial settings:

Step 1: Select the menu language as you need.

Note: English(New Zealand) is recommended.

Illustrations within this publication are provided for reference only.

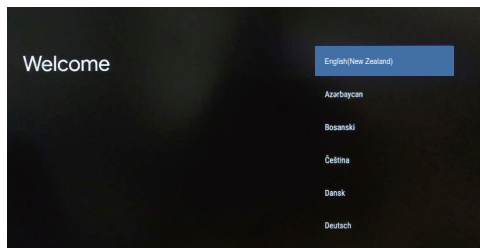

Step 2: (Only for some countries) Select whether or not to use an Android device to setup the TV.

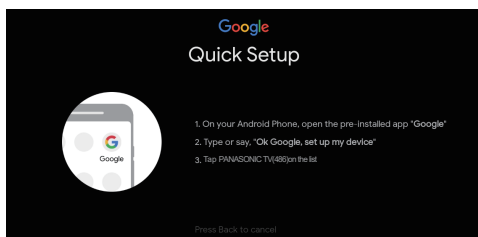
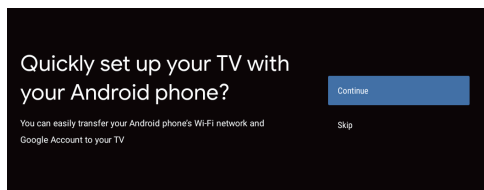

Initial Setting

Initial setup involves selecting all the settings required to be able to search for and store all the analogue channels you can receive.

Make sure that the television is switched on and follow all the steps in turn specified hereafter.

The first time you switch the set on, the Initial Setup wizard opens, which guides you through the initial setup process.

Step 1: Environment

Press ▲/▼ to select your environment. Then press OK to enter next step.

Home Mode: You would be able to view the standard settings for Picture and sound modes.

Shop Mode: You can enjoy enhanced setting for Picture and Sound modes.

Note: Picture mode setting will not be accessible when you select Shop Mode.

Step 2: Where are you?

Press ▲/▼ to select your Country/Region. Press OK to confirm and move to next step.

Step 3: Terms & Conditions

Use ▲/▼ to read Terms & Conditions, then press OK to confirm and move to next step.

Step 4: Channel installation

Use ▲/▼ to select Tuner mode: Antenna, Cable and Satellite; Type: Digital, Analogue and All, then press OK to confirm and move to next step.

Step 5: Please check settings

When all setup is done, the [Please check settings] interface displays on the screen, and press OK to finish the initial setup. You can also go back to former step and make any changes by using ← button.

Step 1:

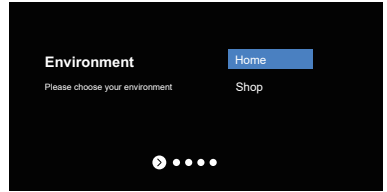

Step 2:

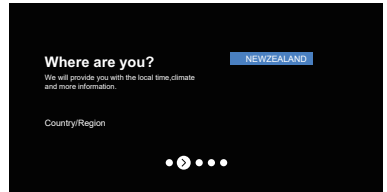

Step 3:

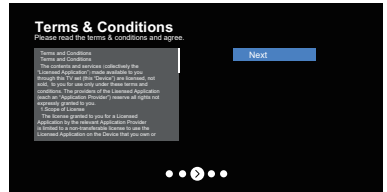

Step 4:

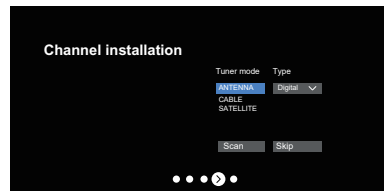

Step 5:

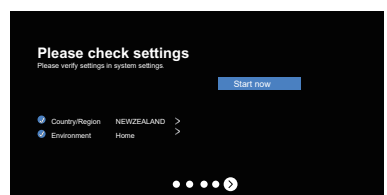

Setup is now complete and your TV is ready for viewing.

Note

































- If tuning has failed, check the connection of the RF cable, then follow the on-screen instructions.

Operating the TV

Using the remote control

Remote Control Functions

Most of your television's functions are available via the menus that appear on the screen. The remote control supplied with your set can be used to navigate through the menus and to configure all the general settings.

- POWER**  (On/Off button) Turns the TV on or off
- PICTURE**  To enter the picture mode.
- OFF TIMER**  To enter the sleep timer.
- INPUT**  To enter source selection interface
- NETFLIX**  Goes to the NETFLIX homepage
- YouTube**  Goes to the YouTube homepage
- prime video**  Goes to the prime video homepage
- AUDIO LINK**  Goes to the AUDIO LINK homepage
- Google Play**  Goes to the Google Play homepage
- APPS**  To select the apps
- Colour buttons** Performs multiple operations which correspond to the operation guide displayed on the menu screen
 - MENU**  To open the settings menu
 -  Goes to the smart TV homepage
 -  Press to display the electronic programme guide
 -  Display to the information
- EXIT**  To exit the program
- OK**  Confirms your selection.
-  (up, down, left and right direction buttons) Highlights different items in the menu system and adjusts the menu controls.
- BACK**  Exit the menu and return to the previous menu
- OPTION**  Displays the options menu of selected functions
- FAV**  To enter the channel list
 -  (Mic)
(Available only when the network connection is normal.)
 -  To open the apps,move the apps or remove from favorites
 -  To fast backward
 -  To play
 -  To fast forward
 -  To end the running program
 -  To pause
 -  Start recording
 -  Increases or decreases the volume
- MUTE**  To mute and un-mute the sound
- TEXT**  To show the text
- STTL**  To show the subtitles



▲	Channel up / down
▼	Channel up / down
0-9	Select the digital key number
MEDIA PLAYER	To enter the media player
AD	Audio description

How to Pair Remote Control with the TV

This is a Bluetooth remote control, and before using it, please pair it with the TV firstly. The following steps are for your reference:

Step 1: Press  button to enter the home page.

Step 2: Press  button to enter the "RC pairing".



Step 3: Follow the "Settings tips page", Press **OK** and  together.

Step 4: The screen will display "Pairing...", Pair finished the screen will display "Success!".

NOTE: If you wait more than 2 minutes and it can't pair, please repeat the above steps for pairing again.

If you want to unpair the Bluetooth remote, As follow:

Step 1: Press  button to enter the home page.

Step 2: Press  to choose , and then press **OK** to enter.

Step 3: Press  to select "Remotes & Accessories" and then to choose the Bluetooth remote name to enter next steps.

Step 4: Press unpair and then choose OK button.

■ When remote control does not respond

1. Press and hold the button as shown below for 3 seconds to reset remote control.



2. Aim remote control reception and unpair by following below.
Home > Settings > Remotes & accessories > RCU03 > Unpair

Using the TV controls

43/50/55/65/75-inch model

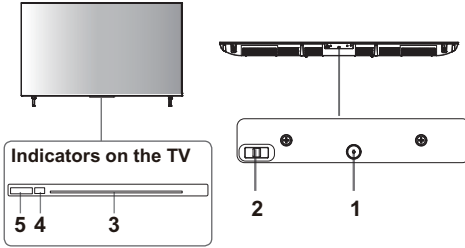







1 Power On /Power Off

- The TV is off, short press the button to turn on the power.
- The TV is on, short press the button, the virtual button will display as shown below.



- When the virtual button appears, press the button briefly to switch the button key functions.
- When the virtual button is present, press the button long enough (for more than 1 second), can perform the following functions.

-  **Power off**
To turn Off the apparatus completely, you must pull the mains plug out of the mains socket.
-  **Next channel**
-  **Previous channel**
-  **Volume increase**
-  **Volume reduction**
-  **Input source**
Long press display input source option, release when the cursor jumps to the source to be switched.

2 Voice On / Voice Off

- Turn it left to set it On, the indicator light will lighting and then go off, follow the steps below to set the Voice:
Home > Settings >Device Preferences > Google Assistant > On
- Follow the steps that appear on the screen, you can say "Ok Google" to use voice function, and the indicator will lighting when the TV receives the voice, then directly say your request.
- Turn it right to set it Off to exit voice function, indicator light will go to yellow.

Note

- Make sure the TV is connected to the Internet before using Voice.
- Please set it to On before using Voice.
- Please log in to your GOOGLE account before using Voice.

3 Power LED

- White: Standby

4 Remote control signal receiver

5 Voice signal receiver

- Yellow: Off

Watching External Inputs

1 Connect the external equipment. → (p. 6 - 7)

2 Display the [Input] menu, then select the input of the connected equipment.

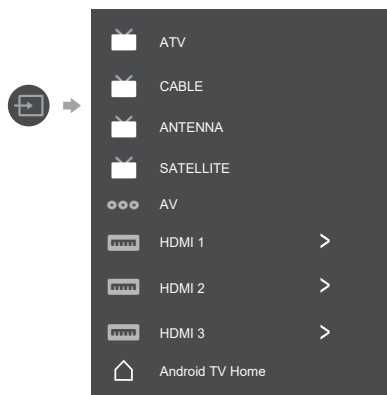

Press OK key access.

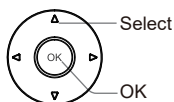

Note





- If the external equipment has an aspect adjustment function, set it to "16:9".

Using Homepage - Apps



Note: This manual is for common use. Figures and illustrations in this User Manual are provided for reference only and may differ from actual product appearance. And for some models, certain options are not available.

You can select all the features from homepage.

Press  to display homepage.

Press /// to select icons from the screen list.

Press **OK** to enter each option.

To exit the APP, press  or .

Google Assistant: Click to interact with Google Assistant of the TV.

Notifications: Remind you of system-critical information, such as low disk space, Google sign in or account errors, network connectivity issues, etc.

Input: Select the input source.

Settings: Access the system setting.

Apps: Show the list of favorite applications, or access the application center.

Customize channels: Add and remove channels from your Home screen.

Note:

- 1) The functions and contents of "Home Page" may vary by different countries or models.
- 2) Before using network functions in home page like network applications and so on, please connect the TV to the network firstly.
- 3) Icon copyrights are owned by the application providers.

Using the Menu Functions

Using Quick Access Menu

Note: Some of the functions might be unavailable in certain sources. And for some models, certain options are not available.

This section explores the menus and settings of your TV. Each menu is outlined and detailed to help you get the most from your TV. To access the menu system:

1. In TV mode, press **MENU** on the remote control to display the quick access list.
2. Press **▲/▼** to select the desired item, then press **OK** to open the corresponding submenu.
3. In submenu, use **◀/▶** and **OK** buttons to make the adjustments, or use **▲/▼** to select an item, use **OK** to enter and operate according to the on-screen display or guide.
4. Press **↶** to return to the previous menu.

Menu

Picture: Enter to adjust picture mode or advanced settings.

Sound: Select this option to set the sound adjustments.

Channel: Select this option to adjust the channel.

System: Select this option to adjust the settings.

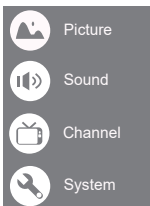

Picture

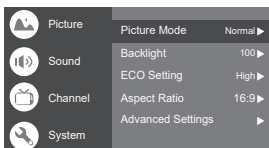

Picture Mode: To select the mode of Normal, Dynamic, Filmmaker, Sport, Game and Custom.

Backlight: Select the level of 0-100.

ECO Setting: To select the Off, Low and High.

Aspect Ratio:

Displays the [Aspect Ratio] screen. Follow the operation guide to select the mode. [16:9] / [4:3] / Auto / Original.

Advanced Setting:

Color Temperature: To select the Normal, Warm, Cool.

Dynamic Contrast: To select ON or OFF.

HDMI PC/ AV Mode: Video/PC/AVto

Overscan: To select ON or OFF

Noise Reduction: To select Off, Low, Middle, High and Auto.

Picture Reset: To reset the picture.

Motion Estimate and Motion Compensation(MEMC):

To select Off, Low, Middle and High.

Gamma: Select 2.2 or 2.4.

Sound

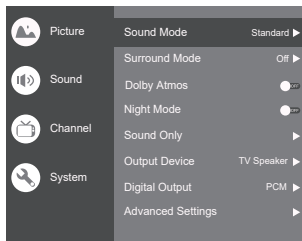

Sound Mode: To select the mode of Standard, Speech, Music, Stadium and User.

Surround Mode: Select Off/ Pure Sound/ Surround.

Dolby Atmos: Select ON or OFF.

Night Mode: Select ON or OFF.

Sound Only: Select it and the TV screen will turn off in 10 seconds.

Output Device: To select the TV Speaker, SPDIF/Optical and HDMI-ARC.

Digital Output : Select the PCM/ByPass/Auto.

Advanced Settings:

1. DAC-4 Dialogue Enhancer
2. DAC-4 Dialogue Enhancer Level
3. Balance
4. Digital Audio Delay (ms)
5. Digital Audio Volume
6. eARC
7. Sound Reset

Channel

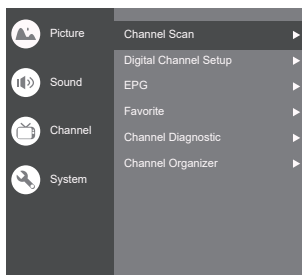

Note: This function is only available in TV mode.

Channel Scan: Allows you to scan for all available analog and digital channels.

Digital Channel Setup:

To select the option to adjust the Subtitle Setup, Teletext Setup, Audio Setup, LCN, Auto service Update, Update Scan(Auto Scan) and HbbTV Settings.

EPG:

Press **OK/▶** to enter the Program Guide menu.

Favorite:

Setup favorite channel list.

Channel Diagnostic:

Press **OK/▶** to display some signal information on current digital channel, such as signal strength, Frequency, etc.

Channel Organizer:

This option allows you to organize channels.

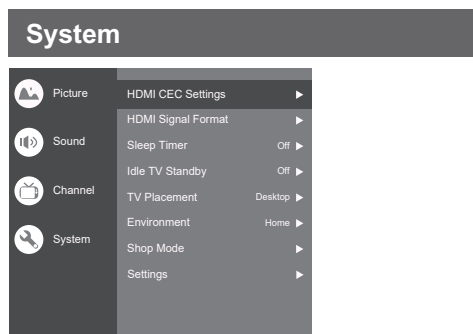

HDMI CEC Settings:

CEC control: To select On or Off.

Device Auto Power Off: To select On or Off.

TV Auto Power On: To select On or Off.

CEC Device List: Turn devices on and select [Enable] to enable control of HDMI devices.

HDMI Signal Format:To select HDMI 1.4 / HDMI 2.0.

Sleep Timer:To select 15min,30min,45min,60min,90min, 120min or Off.

Idle TV Standby:To select After 1 hour of inactivity, After 2 hour of inactivity,After 4 hour of inactivity,After 24 hour of inactivity or Off.

TV Placement:To select Desktop and Wallmount.

Environment:To select Home and Shop.

Shop Mode:To select E-Sticker.

Settings:

1.Lock: Click and lock the TV.

2.Power: Turn the Wake On Network and Network Standby on or off.

3.Recording Storage: Put the storage device and record the storage.

4.OSS License: The content about oss license.

5. Version: Software version.

6.User ID: User ID in use.

Channels setup

Analogue setup:Select ATV and enter.

- Analogue Auto Tuning: Press OK to start the automatic search process. The search may take a few minutes.

- Analogue Manual Tuning: Press OK to enter the interface.

Press **▲/▼** to set program, Audio system or color system item, then Press **▲/▼**select frequency and press OK to search channel.

- Teletext Setup: Press OK and then use **▲/▼** to select preferred teletext.

Digital Cable Tuning:Select Cable and enter.

Auto tuning: Press OK to start the automatic search process. The search may take a few minutes. During the process, you can press Back and choose YES to exit .

Manual Tune: Select the channel number and start to scan LCN: Select on or off.

Auto service Update: Select on or off.

Digital Antenna Tuning:Select Antenna and enter.

Auto Scan: Press OK to start the automatic search process. The search may take a few minutes. During the process, you can press Back and choose YES to exit .

Manual Scan: Select the channel number and start to scan

Press MENU button, then select Channel and press OK to enter Digital Channel setup, press OK to select Subtitle Setup.

Subtitle Setup:

(1)Subtitle Setting:Include off,Basic,Hearing impaired.

(2)Primary Preferred Language:Press OK and then use **▲/▼** to select Primary Preferred Language.

(3)Secondary Preferred Language:Press OK and then use **▲/▼** to select Seconcd Preferred Language.

Press MENU button, then select Channel and press OK to enter Digital Channel setup, press OK to select Teletext Setup.

Teletext Setup: Press OK and then use **▲/▼** to select preferred teletext or Decoding Page Language.

Press MENU button, then select Channel and press OK to enter Digital Channel setup, press OK to select Audio Setup. Audio Setup:

(1)Audio Description:Include Off and On.

(2)Audio Description Mixing Level:Press OK and then use **◀/▶** to set Audio Description Mixing Level.

(3)Audio Type: You can set the audio type.

(4)Primary Preferred Language:Press OK and then use **▲/▼** to select Primary Preferred Language.

(5)Secondary Preferred Language:Press OK and then use **▲/▼** to select Seconcd Preferred Language.

LCN: Select On or Off.

Auto service Update: Select On or Off.

Update Scan(Auto Scan): Include Off and On.

HbbTV Settings: Use the **▲/▼** to select the corresponding option to set.

Satellite Setting

1. Selection of Satellite source.
2. Use the ▲/▼ to moves to Digital Satellite Tuning.
3. Pushing OK in Freeview Setup, then select Freeview.

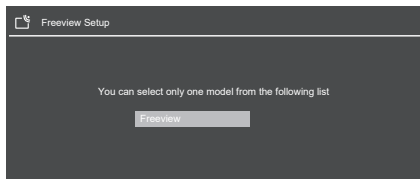

4. The Select Region is displayed.
5. Move the focus to the region where you are resident and push OK.

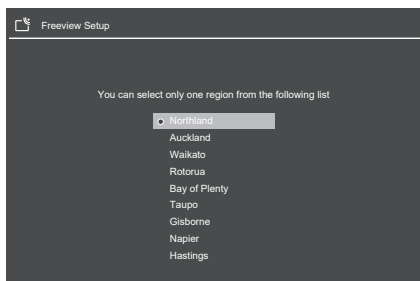

6. After the region selection is done, the satellite tuning scan commences.
7. Pushing OK in Satellite Tune moves to UI with SATELLITE, Transponder and Optus D1 columns (below UI).
8. Satellite 01 Ku-Optus D1 has to be selected by OK for Freeview service tuning.

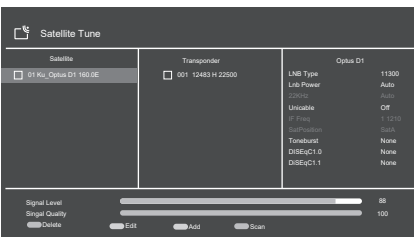

Note:

Freeview satellite transponder has been selected. Signal Level and Signal Quality bars need to be blue coloured. Please press Blue button to scan.

If Signal Level and Signal Quality are zero, please change the LNB Type to 10750. Move the focus to LNB Type and push OK to display the frequency list. Move the focus to 10750 and push OK.

9. Pressing Blue button when the focus is on Scan results in Freeview tuning channel search to be displayed (below UI).

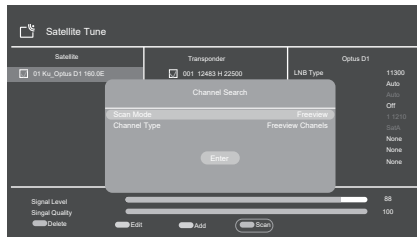

10. There is a serious problem if the viewer pushes directly without selecting and getting a tick in the box for Optus D1 and transponder 12483MHz. The tuning jumps directly to below tuning menu that does not allow selection of Freeview.

Recording to USB HDD

This operation only works under the Digital TV source, please insert a USB with storage space before recording.

Select Saved USB to view or select as follows: Press MENU > SYSTEM > SETTINGS > RECORDING STORAGE.

1. Press the Record button on the remote control, then press the ▲/▼ button to select the time to be recorded. To stop recording, press the ■ button.
2. Press OK button then use ◀/▶ select Start Recording, or press 📺 button on remote control to enter EPG.

Press ▲/▼◀/▶ select the program you want to record, press OK button then select Timer REC to set the recording, and select Set timer after completion, and the TV will record at the set time.

3. To watch the recorded program, press the OK button and then use the ◀/▶ button to select the Recorded programs, and press the ▲/▼ button to select the recorded program to watch or delete. If you want to quit watching, press the back button to quit viewing.

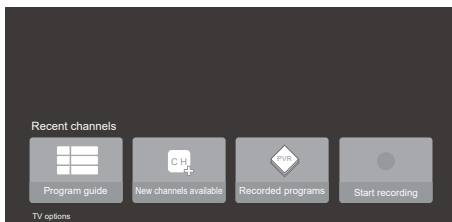

Using Media Player

Media Player allows you to enjoy photo, music or video recorded on a USB Flash Memory.

- The picture may not appear correctly on this TV depending on the digital cameras used.
- Display may take some time when there are many files and folders in the USB Flash Memory.
- Partly degraded files might be displayed at a reduced resolution.
- The folder and file names may be different depending on the digital camera used.

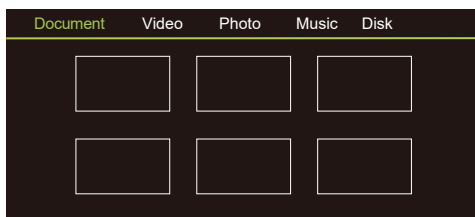

Document:

1. Select **Document** icon.
2. Press Up, Down, Left or Right direction button to select your desired file and press OK to Play.
3. Use OK key to see more option: ZOOM+, ZOOM-.
4. Press Return key of remote to Stop playing.

Video:

1. Select Video icon, then press OK button to view movie file.
2. Press Up, Down, Left or Right direction button to select your desired file and press OK to Play.
3. While playing a Video, press OK Menu of remote to display the play console. For the Play console, Press Ok key of remote to Play and Pause the video file. Left key of remote to Fast backward. Right key of remote to Fast forward.
4. Use OPTION key to see more option: Photo scale, Looping mode, Subtitle, Subtitle code, Audio track, information and video list.
5. Press Return key of remote to Stop playing and Press Return to Exit.

Photo:

1. Select Picture icon, then press OK button to view the picture.
2. Press Up, Down, Left or Right direction button to select your desired picture file and press OK to show.
3. While showing picture, press OK to display the play console. For Previous and Next use remote left and Right key.
4. Use OK key to see more option: Left rotation, Right rotation, ZOOM+, ZOOM-, Manual play/Auto play, Information, Play mode, Play interval, BGM: on or off.

Music:

1. Select Music icon, then press OK button to listen to Music.
2. Press Up, Down, Left or Right direction button to select your desired file and press OK to Play.
3. The Play console includes Previous, Play/Pause, Fast backward/Fast forward, Next. Press OPTION key to see PlayList.
4. Press Return key of remote to Stop playing.

Disk:

1. Select **Disk** icon, then press OK button to choose folder.
2. Press Up, Down, Left or Right direction button to select your desired file and press OK to Play.
3. Press Return key of remote to Stop playing.

Inserting / Removing the USB Flash Memory

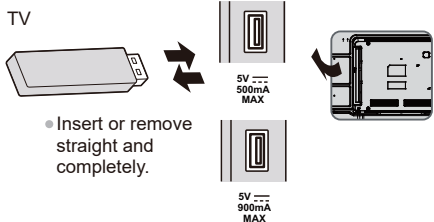

Starting Media Player

- 1 Insert the USB Flash Memory.
- 2 Select the mode.



[DOCUMENT]: Displays the thumbnail of all documents in the USB Flash Memory.

[PHOTO]: Displays the thumbnail of all photos in the USB Flash Memory.

[MUSIC]: Displays the thumbnail of music folders in the USB Flash Memory.

[VIDEO]: Displays the thumbnail of video titles in the USB Flash Memory.

[DISK]: Displays the thumbnail of all document in the USB Flash Memory.

[Contents Display]

Follow the operation guide to perform available operations.

When the cursor stays on the icon, it displays the information of the highlighted content.

Additional Information

Auto power standby function

The TV will automatically go into Standby mode in the following conditions:

- No signal is received for 15 minutes.
- [Sleep timer] is active in the [System] menu (p. 15).

Input signal that can be displayed

Signal name	HDMI
525 (480) / 60i, 60p	○
625 (576) / 50i, 50p	○
750 (720) / 60p, 50p	○
1,125 (1,080) / 60i, 50i	○
1,125 (1,080) / 60p, 50p, 24p	○
2,250 (2,160) / 60p, 50p, 24p	○

- Mark : Applicable input signal
- Signals other than above may not be displayed properly.
 - The above signals are reformatted for optimal viewing on your display.

HDMI connection

This TV incorporates HDMI™ technology. HDMI (high-definition multimedia interface) is the world's first complete digital consumer AV interface complying with a non-compression standard.

HDMI allows you to enjoy high-definition digital images and high-quality sound by connecting the TV and the equipment.

■ Applicable HDMI features

- Input audio signal:
2ch Linear PCM (sampling frequencies - 48 kHz, 44.1 kHz, 32 kHz)
- Input video signal:
➡ **"Input signal that can be displayed"** (p. 18)
Match the output setting of the digital equipment.

USB Flash Memory

For playing back in Media Player

Format: FAT32

Compliance:

- USB2.0 port: Supports only USB1.1 or USB2.0 standard.
- USB3.0 port: Supports only USB1.1 or USB2.0 or USB3.0 standard.
- Maximum USB capacity supported is 1TB.

Note

- Data modified with a PC may not be displayed.
- Do not remove the device while the TV is accessing data. Otherwise this can damage the device or TV.
- Do not touch the pins on the device.
- Insert the device in the correct direction. Otherwise this can damage device or TV.
- Electrical interference, static electricity, or erroneous operation may damage the data or device. Panasonic is not liable for any deterioration or damage of data or device during operations with the TV.
- It is recommended to connect the USB Flash Memory directly to the TV's USB port.
- Some USB devices or USB HUB may not be used with this TV.
- You cannot connect any devices by using USB card reader.
- Additional information for USB devices may be on the following website. (English only)
<http://panasonic.jp/support/global/cs/tv/>
- If you need to expand the memory, you can format the USB expansion memory.
Home > Settings > Device Preferences > Storage > VendorCo USB drive > Delete and format as device storage
If want to restore USB functionality, following below format again.
Home > Settings > Device Preferences > Storage > VendorCo USB drive > Erase & format as removable storage
** This operation has the risk of damaging the USB, please proceed with caution.*

Supported file format in Media Player

■ Image Decoder

JPEG; PNG; BMP; GIF

■ Video Decoder

MPEG1/2/4; H.264; H.265; AVI; WMV; VP8 ; M-JPEG

■ Audio Decoder

PCM; LPCM; MPEG1/2/4; AAC; WMA; AC3; EAC3; FLAC

■ Subtitles

- The video file and subtitles text file are inside the same folder, and the file names are the same except for the file extensions.
- If there are more than one subtitles text file inside the same folder, they are displayed in the following order of priority: ".srt", ".sub".

Note

- Even if these conditions are fulfilled, some files may not play depending on how they are encoded.
- Do not use two-byte characters or other special codes for data.
- Connected devices may become unusable with this TV if the file or folder names are changed.

Read Before Playing Photo, Video, or Music Files

Read this information before playing media content.

Limitations on use of photo, video, and music files

- The TV supports MSC(Mass Storage Class) USB devices only. MSC is a class designation for mass storage devices. Types of MSC devices include external hard drives, flash card readers, and digital cameras. (USB hubs are not supported.) These kinds of devices must be connected directly to the USB port. The TV may not be able to recognise a USB device or read the files on the device if it is connected with a USB extension cable. Do not disconnect USB devices while they are transferring files.
- When connecting an external hard drive, use the USB(HDD) port. We recommend that you use an external hard drive with its own power adapter.
- Certain digital cameras and audio devices may not be compatible with the TV.
- The TV supports the FAT file systems.
- After sorting files in the Folder view mode, the TV can display up to 1,000 files per folder. If the USB device contains more than 8,000 files and folders, however, some files and folders might not be accessible.
- Certain files, depending on how they are encoded, may not play on the TV.
- Certain files are not supported on all models.
- DivX and DTS codecs are not supported by the Panasonic.

Troubleshooting

Before requesting service or assistance, please follow these simple guides to resolve the problem.

If an error message appears, follow the message's instructions.

If the problem still persists, please contact your local Panasonic dealer for assistance.

Screen

Red, blue, green or black spots on the screen.

→ This is the characteristic of liquid crystal panels. The liquid crystal panel is built with very high precision technology. Occasionally, a few non-active pixels may appear on the screen as points of red, green, blue or black. This does not affect the performance of your TV and it is not a quality problem.

Chaotic image, noisy.

- Set [Noise reduction] in the [Picture] menu to remove noise (p. 14).
- Check nearby electrical products (car, motorcycle, fluorescent lamp).

No image is displayed.

- Check the settings of [Contrast] or [Brightness] in the [Picture] menu (p. 14).
- Check the TV is in AV mode. If the TV is in AV mode, check the selected input mode match the output of the external equipment (p. 13).

Unusual image is displayed.

- Turn the TV off with Mains power On / Off switch (p. 12), then turn it on again.

Pictures from equipment connected via HDMI are unusual.

- Check the HDMI cable is connected properly.
- Turn the TV and equipment off, then turn them on again.
- Check an input signal from the equipment (p. 18).
- Use equipment compliant with EIA/CEA-861/861D.

Sound

No sound is produced.

- Check the sound mute setting (p. 14) and volume.

Low level or distorted sound.

- Sound signal reception may be deteriorated.

Sound output via HDMI connection is unusual.

- Set the sound setting of the connected equipment to "2ch L.PCM".

General

The TV goes into Standby mode.

- This TV is equipped with auto power standby function (p. 18).

The remote control does not work or is intermittent.

- Replace the batteries (p. 5).
- Point the remote control directly at the remote control signal receiver of the TV (within about 7 m and 30 degree angle).
- Situate the TV away from sunshine or block sources of bright light from shining on the remote control signal receiver of the TV.

Parts of the TV become hot.

- Even if the temperature of parts of the front, top and rear panels has risen, these temperature rises do not cause any problems in terms of performance or quality.

The TV panel moves slightly when it is pushed with a finger.

Clattered sound might be heard.

- There is some flexibility around the panel to prevent damage. This is not a malfunction.

Overcurrent error message appears.

- The connected USB device might cause this error. Remove the device and turn the TV off with Mains power On / Off switch, then turn it on again.
- Check foreign objects are not inside the USB port.

Maintenance

First, remove the mains plug from the socket outlet.

Regular care

- Gently wipe the surface of the display panel, cabinet and pedestal by using a soft cloth.
- Wipe the mains plug with a dry cloth at regular intervals. Moisture and dust may lead to fire or electrical shock.

For stubborn dirt

First clean the dust on the surface. Dampen a soft cloth with clean water or diluted neutral detergent (1 part detergent to 100 parts water). Wring the cloth and wipe the surface. Finally, wipe away all the moisture.

Caution

- Do not use a hard cloth or rub the surface too hard as this could scratch the surface.
- Do not subject the TV's surfaces to water or detergent. Liquid inside the TV could lead to product failure.
- Do not subject the surfaces to insect repellent, solvent, thinner or other volatile substances. This may degrade surface quality or cause peeling of the paint.
- The surface of the display panel is specially treated and may be easily damaged. Take care not to tap or scratch the surface with your fingernail or other hard objects.
- Do not allow the cabinet and pedestal to make contact with a rubber or PVC substance for a long time. This may degrade surface quality.

Specifications

Model no.

43-inch model
TH-43LX800Z

50-inch model
TH-50LX800Z

55-inch model
TH-55LX800Z

65-inch model
TH-65LX800Z

75-inch model
TH-75LX800Z

Power source

AC 100 - 240 V, 50/60 Hz

Power consumption

(Rated power / Standby power)

43-inch model	65-inch model
120 W / 0.5W	260 W / 0.5W

50-inch model	75-inch model
165 W / 0.5W	310 W / 0.5W

55-inch model
210 W / 0.5W

Display panel

Panel

LCD panel (LED backlight)

Visible screen size (diagonal)

43-inch model: 108 cm

50-inch model: 126 cm

55-inch model: 139 cm

65-inch model: 164 cm

75-inch model: 189 cm

Display resolution

43-inch model: 3,840 (W) × 2160 (H)

50-inch model: 3,840 (W) × 2160 (H)

55-inch model: 3,840 (W) × 2160 (H)

65-inch model: 3,840 (W) × 2160 (H)

75-inch model: 3,840 (W) × 2160 (H)

Dimensions (W × H × D)

43-inch model
965 x 617 x 219 mm (With Pedestal)
965 x 572 x 83 mm (TV only)

50-inch model
1120 x 720 x 269 mm (With Pedestal)
1120 x 658 x 83 mm (TV only)

55-inch model
1234 x 787 x 269 mm (With Pedestal)
1234 x 725 x 83 mm (TV only)

65-inch model

1453 x 912x 318 mm (With Pedestal)

1453 x 846 x 83 mm (TV only)

75-inch model

1673 x 1036 x 365 mm (With Pedestal)

1673 x 970 x 83 mm (TV only)

Mass

43-inch model

8.4 kg (With Pedestal)

8.2 kg (TV only)

50-inch model

10.8 kg (With Pedestal)

10.4 kg (TV only)

55-inch model

14.7 kg (With Pedestal)

14.4 kg (TV only)

65-inch model

19.7 kg (With Pedestal)

19.1 kg (TV only)

75-inch model

29.8 kg (With Pedestal)

28.7 kg (TV only)

Connection terminals

AV in

Mini, 1.0 V[p-p] (75 Ω)

EARPHONE

Mini, 150mV rms ~ 250mV rms

HDMI 1 / 2 / 3 input

TYPE A Connectors

USB

USB 2.0/3.0 TYPE A Connectors

USB2.0 DC 5V, Max.500 mA

USB3.0 DC 5V, Max.900 mA

Speaker Output

43/50/55/65/75-inch model

Audio output

20 W (10 W + 10 W)

Receiving systems / Band name

9 Systems

Systems	Function
1 PAL B, G	Reception of broadcast
2 PAL I	
3 PAL D, K	
4 SECAM B, G	Playback from Special VCR's or DVD
5 SECAM D, K	
6 PAL	Playback from Special Disc Players and Special VCR's or DVD
7 PAL 60 Hz/5.5 MHz	
8 PAL 60 Hz/6.0 MHz	
9 PAL 60 Hz/6.5 MHz	

Receiving channels (Analogue TV)

VHF BAND

- 2-12 (PAL/SECAM B, K1)
- 0-12 (PAL B AUST.)
- 1-9 (PAL B N.Z.)
- 1-12 (PAL/SECAM D)

UHF BAND

- 21-69 (PAL G, H, I/SECAM G, K, K1)
- 28-69 (PAL B AUST.)
- 13-57 (PAL D, K)

Digital TV

- DVB-T/T2 Standard
- DVB-S/S2 Standard

Aerial input

VHF / UHF

Operating conditions

Temperature

0 °C - 45 °C

Humidity

20 % - 80 % RH (non-condensing)

Note

- Design and Specifications are subject to change without notice. Mass and Dimensions shown are approximate.

Built-in wireless LAN

Standard compliance and Frequency range

IEEE 802.11 a/b/g/n/ac
2.4~2.5GHz and 5.15~5.825GHz

Security

Support for WPA/WPA2

Built-in Bluetooth

Bluetooth V5.0
2.4~2.485GHz

Oss License

This product incorporates the following software:

- (1) The software developed independently by or for Panasonic Entertainment & Communication Co., Ltd.,
- (2) The software owned by third party and licensed to Panasonic Entertainment & Communication Co., Ltd.,
- (3) The software licensed under the GNU General Public License, Version 2.0 (GPL V2.0),
- (4) The software licensed under the GNU LESSER General Public License, Version 2.1 (LGPL V2.1), and/or
- (5) Open source software other than the software licensed under the GPL V2.0 and/or LGPL V2.1.

The software categorized as (3) - (5) are distributed in the hope that it will be useful, but WITHOUT ANY WARRANTY, without even the implied warranty of MERCHANTABILITY or FITNESS FOR A PARTICULAR PURPOSE. Please refer to the detailed terms and conditions thereof **【system > settings > Oss License】**

At least three (3) years from delivery of this product, Panasonic will give to any third party who contacts us at the contact information provided below, for a charge no more than our cost of physically performing source code distribution, a complete machine-readable copy of the corresponding source code covered under GPL V2.0, LGPL V2.1 or the other licenses with the obligation to do so, as well as the respective copyright notice thereof.

Contact Information: osd-cd-request@gg.jp.panasonic.com

WARRANTY - New Zealand only

WE WARRANT that the Panasonic Television that you have purchased is free from defects in material and workmanship under normal home use and service.

Accordingly, we undertake to repair, or at our option, replace without cost to the owner, either for material or labour, any part which within 12 months from the date of delivery is found to be defective, provided that the appliance has been used for domestic purposes only and in accordance with the instructions given in the Instruction Book and not been subjected to misuse, neglect or installed, dismantled, repaired or serviced by any other than an authorised Panasonic New Zealand Dealer or Panasonic New Zealand Authorised Service Centre.

NOTE

- Before reporting a fault, please ensure that you read the item "Troubleshooting" in the information section of your Panasonic Instruction Book.
- It is important to retain your proof of purchase as this will be required by the serviceman or retailer as proof of purchase date, should service be required.
- In the event of service being required, contact your Panasonic New Zealand retailer or Panasonic New Zealand Authorised Service Centre.

IMPORTANT

Any request for warranty service must be through an Authorised Panasonic New Zealand Service Centre who during the period of the warranty, undertakes to make any necessary adjustment and fit any replacement part supplied by the manufacturer, during normal working hours, or alternatively will arrange for such service to be provided by some other Panasonic New Zealand Authorised Service Centre.

NEW ZEALAND

Distributed in New Zealand by Panasonic New Zealand Limited

18 Sir Woolf Fisher Drive, Highbrook, East Tamaki, Private Bag 14911, Panmure, Auckland

Tel. 09 272 0100

Customer Care Center

Email: Customerservice@nz.panasonic.com

www.panasonic.co.nz

Information on Disposal in other Countries outside the European Union



This symbol is only valid in the European Union. If you wish to discard this product, please contact your local authorities or dealer and ask for the correct method of disposal.

Customer's Record

The model number and serial number of this product may be found on its rear panel. You should note this serial number in the space provided below and retain this book, plus your purchase receipt, as a permanent record of your purchase to aid in identification in the event of theft or loss, and for Warranty Service purposes.

Model Number _____

Serial Number _____

Panasonic Entertainment & Communication Co., Ltd.

Web Site: <http://www.panasonic.com>

English

72-55LX8Z-E51Z2