

## Operating Instructions

**Household Use** Electronic Rice Cooker

Model No. 1.5 L **SR-DA152**  
1.8 L **SR-DA182**

### Contents



The pictures in these instructions use SR-DA182 as an example.

Thank you for purchasing this Panasonic product.

- This product is intended for household use only.
- Please read these Operating Instructions carefully for safe and proper use of this product. Be sure to read the "**Safety Precautions**" (page 2 - 3) before use.
- Make sure that information such as date of purchase and dealer's name are stated on the warranty card.
- Keep warranty card together with Operating Instructions.

Keep for future use

|                                 |            |                   |
|---------------------------------|------------|-------------------|
| <b>Safety Precautions</b> ..... | <b>2-3</b> | <b>Before use</b> |
| Instructions for Use .....      | 4          |                   |
| Parts Identification .....      | 5          |                   |
| • Main body/Control panel ..... | 5          |                   |

|   |     |              |
|---|-----|--------------|
| Preparation .....                                       | 6   | <b>Usage</b> |
| Menu Functions .....                                    | 7-8 |              |
| • White Rice/Brown Rice/Congee/Soup/<br>Keep Warm ..... | 7   |              |
| • Quick Cook/Steam/Timer .....                          | 8   |              |
| Cleaning and Maintenance .....                          | 9   |              |

|                              |       |                        |
|------------------------------|-------|------------------------|
| Troubleshooting .....        | 10-11 | <b>Troubleshooting</b> |
| Error Codes Indication ..... | 12    |                        |
| Specifications .....         | 13    |                        |
| Warranty .....               | 14-15 |                        |

# Safety Precautions

Be sure to observe the following precautions

To prevent personal injury, injury to others and property damage, the following instructions must be followed.

■The following symbols show the damage or harm level caused by incorrect operation.

 **WARNING:** Indicates a potential hazard which could result in death or serious injury.



 **CAUTION:** Indicates a potential hazard which could result in injury or damage to property.

■Classification and description of symbols are as follows.

 This symbol indicates an action that is prohibited.

 This symbol indicates an action that must be followed.

## WARNING

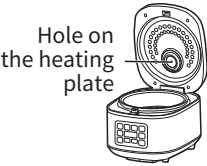
-  Do not use the appliance if the power cord or power plug is damaged or the power plug is loosely connected to the power outlet.  
(To avoid causing an electric shock, or a fire due to a short circuit.)  
→If the power cord is damaged, it must be replaced by a special cord or assembly available from the manufacturer or its service agent.
- Do not damage the power cord or power plug.
  - The following actions are strictly prohibited: Damaging, processing, making contact with or near high-temperature surfaces or heating elements, forcibly bending, twisting, pulling, hanging/pulling over sharp corners, placing heavy objects on it, tying into bundles, sandwiching, pulling the power cord to move.  
(So as to avoid electric shock due to damaged power cord and power plug or avoid fire due to short circuit.)
- Do not connect or disconnect the power plug with wet hands.
  - Make sure your hands are dry before touching the power plug or the product.  
(To avoid causing an electric shock or injury.)
- Do not let anyone lick the instrument plug.  
(To avoid causing an electric shock or injury.)
  - Pay extra attention to children and infants.
- Do not insert anything into the vent or gaps, especially pins or other metal objects.  
(To avoid causing an electric shock or abnormal operation.)
- Do not immerse the appliance in water or splash it with water.  
(To avoid causing an electric shock, or a fire due to a short circuit.)  
→Please contact a Panasonic authorized service center if water gets inside the appliance.
- Do not modify, disassemble, or repair this appliance.  
(To avoid causing a fire, electric shock or injury.)  
→For repair, please contact a Panasonic authorized service center.
- When in use or after cooking, do not put your face or hands near the steam vent. Special attention must be paid to children and infants.  
(To avoid causing a burn.) 
- Do not use this appliance for any purpose other than those described in the Operating Instructions.  
(To avoid causing a fire, burn, injury or electric shock.)
  - Panasonic shall not assume any responsibility for improper use or failure to follow the operating instructions.
- Do not place items which may clog the hole on the heating plate into the pan.  
(So as to avoid burns or injuries resulting from steam or cooked food blowing out.)   
Cooking methods which involve ingredients and seasonings that are placed into a plastic bag to heat cannot be done with this appliance.
- Do not open the lid or move the main body during cooking.  
(So as to avoid burns or injuries resulting from steam or cooked food blowing out.)
- Do not spill water or other liquids on the instrument plug.  
(To avoid causing an electric shock, or fire due to a short circuit.)
- Please use an alternating current power socket with a voltage of AC 230 V - 240 V/10 A.  
(Using the unit together with other equipment on the same outlet can cause overheating and fire.)
  - Only use a power strip rated at least 10 amperes.
- Make sure that the power plug and the instrument plug are fully inserted in place.  
(To avoid causing smoke, fire or electric shock.)
- Single-phase bipolar grounded power outlets should be used for this appliance to ensure reliable grounding. If a grounding device is not installed, electrostatic induction of other metal parts such as housing may occur.  
(To avoid causing the risk of electric shock due to failure or electric leakage.)

# ! WARNING

- **Clean the power plug regularly.**  
(To avoid causing a fire due to poor insulation of the power plug due to accumulation of moisture and foreign matter.)  
→ Disconnect the power plug and wipe it with a dry cloth.
- **This appliance is not intended for use by persons (including children) with reduced physical, sensory or mental capabilities, or lack of experience and knowledge, unless they have been given supervision or instruction concerning use of the appliance by a person responsible for their safety. Children should be supervised to ensure that they do not play with the appliance.**  
(To avoid causing burns, injury or electric shock.)
- **Keep the appliance out of reach of small children.**  
(To avoid causing burns, injury or electric shock.)
- **If an abnormality or malfunction occurs, stop using the appliance immediately and unplug the power plug.**  
(To avoid causing smoke, fire or electric shock.)  
Abnormalities • Malfunction Cases:
  - The power plug and cord become abnormally hot.
  - The power cord is damaged or there are intermittent power outages when being touched.
  - The main body is deformed or abnormally hot.
  - The main body emits smoke or a burning smell.
  - The main body is broken, loose or makes abnormal noise.
  - The heating plate is warped or the pan is deformed.→ Please contact a Panasonic authorized service center for inspection and repair immediately.

# ! CAUTION

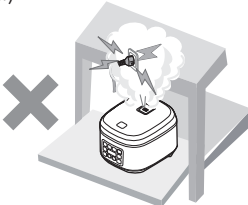
- **Do not use a non-dedicated pan or a deformed pan.**  
(To avoid causing burns or injury due to overheating or malfunction.)
- **Do not use the appliance in the following places:**
  - Near heat or in high humidity environments.  
(To avoid causing electric shock, electric leakage or fire.)
  - On uneven surfaces or a mat which is not heat-resistant.  
(To avoid causing injury, burns or fire.)
  - In places close to walls or furniture, etc.  
(To avoid bumping into them when opening the outer lid, or causing discoloration, deformation and breakage of the furniture.)
- **Do not move the main body while in use.**  
(So as to avoid burns caused by the opening of the outer lid due to touching the hook button.)
- **Do not touch the hot surfaces while the appliance is in use or after cooking.**
  - The main body has a high temperature. In particular, the metal parts such as the heating plate, the pan and cast heater.  
(To avoid causing a burn.)
- **Do not expose the power plug to the steam.**  
(To avoid causing an electric shock, or fire due to a short circuit.)  
→ When using a cabinet with sliding table, use the appliance where the power plug cannot be exposed to steam.
- **Do not let the appliance operate in an empty state.**  
(To avoid causing burns.)
- **Do not connect the appliance to an external timing device or operate the appliance using a separate remote control system.**  
(To avoid fire.)
- **When you unplug the power plug, be sure to hold the plug itself, and never pull the power cord.**  
(To avoid causing an electric shock, or a fire due to a short circuit.)
- **When taking out the pan or when the pan is not in use, remember to turn off the power and unplug the power plug.**  
(To avoid causing burns, injury, or an electric shock, leakage, fire due to insulation aging.)
- **Wait for the main body to cool down sufficiently before cleaning.**  
(To avoid causing burns.)
- **When used within a cupboard or other enclosed spaces, make sure that the steam can emit outward.**  
(To avoid causing discoloration or deformation of the cupboard.)
- **This appliance is intended to be used in household and similar applications such as:**
  - staff kitchen areas in shops, offices and other working environments;
  - farm houses;
  - by clients in hotels, motels and other residential type environments;
  - bed and breakfast type environments.

## If a power outage occurs during use

This includes unplugging of the power plug, trip, etc.

- Return to standby mode.

# Instructions for Use

## About the Main Body

- If the product is on a cabinet with sliding table, make sure that the load capacity of the table is greater than 9 kg. (To avoid dropping the product.)

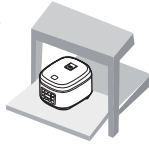

- Do not cover the outer lid with a cloth or other objects when the product is in use. (To avoid causing the steam from being blocked, resulting in deformation, discoloration of the outer lid and malfunction of the product.)



- Please clean rice and other foreign objects that become stuck on the main body (bottom sensor, cast heater, and the bottom of the pan). In order to avoid error displays, scorched rice, half-cooked rice, etc.

Edge or bottom



(Pan)

Cast heater  
Bottom sensor



- Be sure to remove the pan protection bag before use. (So as to avoid poor cooking or fire.)
- Do not pour food that needs to be cooked directly into the protective frame where no pan has been placed. (So as to avoid failure caused by impurities.)
- When there is any overflow of rice water from the steam vent, pull out the power plug immediately to disconnect the power supply. Do not resume use until the rice water on the power plug and the instrument plug is cleaned with a dry cloth.
- Do not use the product outdoors. (Unstable power supply may result in product failure.)
- Avoid using the product under direct sunlight. (So as to avoid color change/discoloration.)
- Do not use this product on items that are not resistant to high temperatures, such as carpets, electric heating carpets, and tablecloths (made of ethylene plastic). (So as to avoid poor cooking or fire.)
- Please make sure to use this product in areas under 2000 meters above sea level. (To avoid affecting cooking performance.)

## About the Inner Pan

- Do not use the pan in places other than the rice cooker.



- Do not use it on a gas stove or induction cooker or in a microwave.



- Avoid hitting the pan against hard objects.



- ( Doing so may cause scratches or dents on the outer surface. )



- Pay attention to the following in order to avoid damaging the coating of the pan.

### Before cooking



- Do not let objects like metal sieves make contact with the coating of the pan.



### During cleaning and maintenance (P9)



- Do not use the pan as a washing container.
- Do not place a spoons or other utensils into the pan.
- After cooking with seasoning, do not leave food inside the pan.  
→ Please clean out the food in the pan as soon as possible and then clean the pan.
- Do not use a bowl dryer or dish washer/dryer for cleaning.
- Do not put the pan onto other utensils to dry after washing.
- Do not use abrasive materials such as powders, metal brushes, nylon brushes or scouring pads to clean or scrub the pan.  
→ To clean the pan, wash it with a soft sponge.



### After cooking



- Do not put vinegar into the rice in the pan. (While cooking Sushi and other food)
- Do not use a metal spoon. (While cooking congee and other food)
- Do not touch or strike the pan. (While filling a bowl with rice)

### Notes

The following will not affect product performance or personal health.

[Outer surface] superficial scratches, small dents or collisions.

[Inner surface] flaking of the coating of the pan.

→ If the pan is deformed or if you are worried about its condition, please purchase a new pan.

# Parts Identification

## Main Body

## Accessories



Rice scoop (1)



Steaming basket (1)



Measuring cup(1)  
(Approx.180 mL)

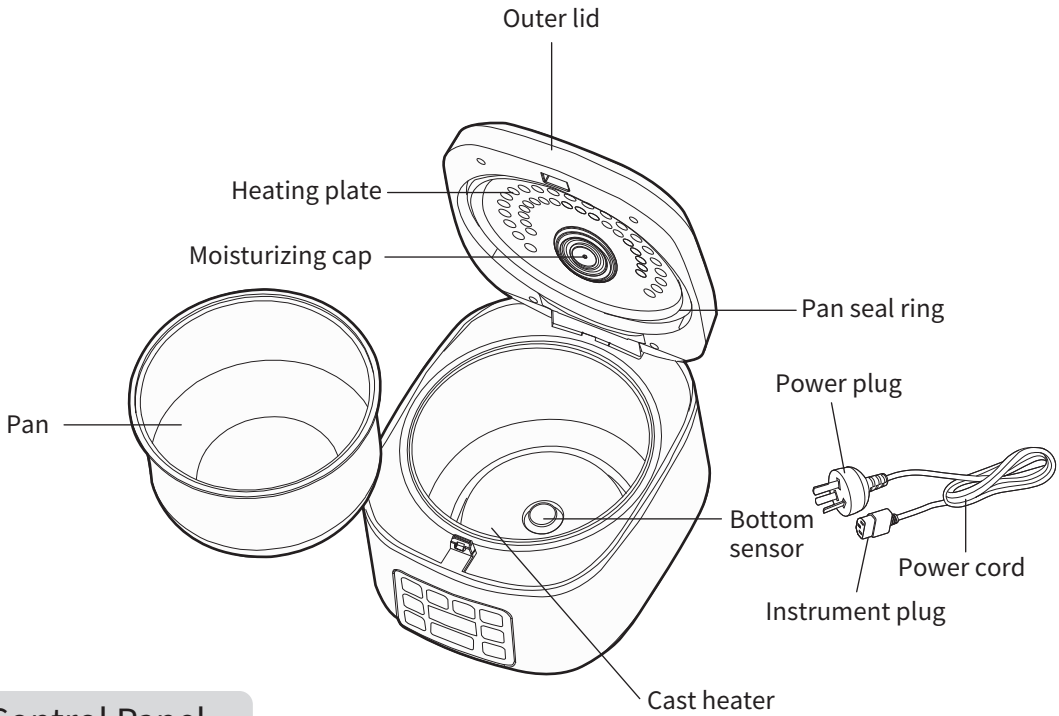

Before use

## Control Panel

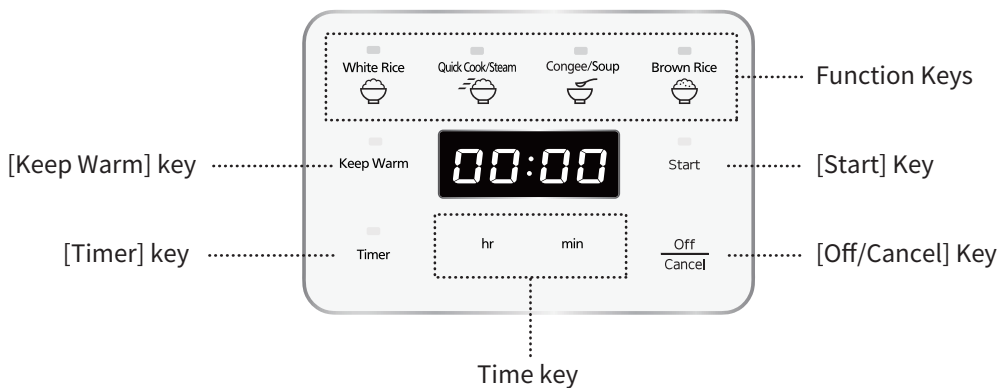

# Preparation

## 1 Measure rice with the measuring cup provided

- Check the maximum quantity of rice that can be cooked at once  
☞ "Specifications" on P13.
- When using the 1.8 L model for quick cooking of rice or cooking of long grain rice, please keep the maximum quantity of rice within 8 cups.

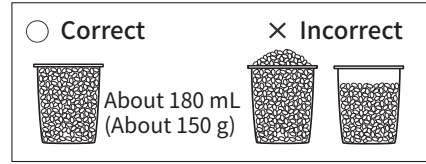

## 2 Wash the rice until the water turns relatively clear

- ① Wash the rice quickly with plenty of water, changing the water as you go.
  - ② Stir the rice gently, and repeat washing several times → rinse with water until the water turns relatively clear.
- In order to avoid scratching the non-stick coating on the pan surface, do not wash rice in the pan.
  - Wash the rice thoroughly. Otherwise, rice crust may appear and the residual rice bran may affect the taste of the rice.

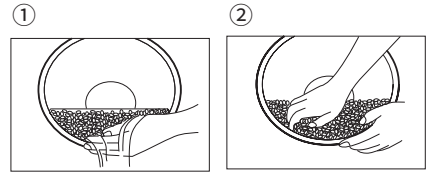

## 3 Place the washed rice into the pan

- Add water up to the corresponding waterline and dry the outside of the pan.
- When adding water, place the pan on a flat surface and flatten the surface of the rice. Confirm that the right amount of water is added based on the correct scale.
  - When too much water is added, it may overflow when cooking.

Example : when cooking 6 cups of rice, add water to the "6" waterline for "White Rice".

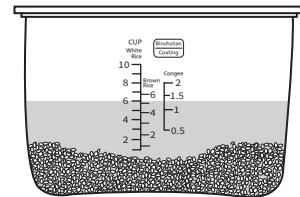

## 4 Put the pan into the body and close the outer lid

- So that the pan bottom can be closely attached to the cast heater, please rotate the pan along the direction indicated by the arrow for 2 or 3 times.
- Check if the moisturizing cap is correctly positioned. (☞ P9)
- When closing the outer lid, confirm that there is a "click" sound.

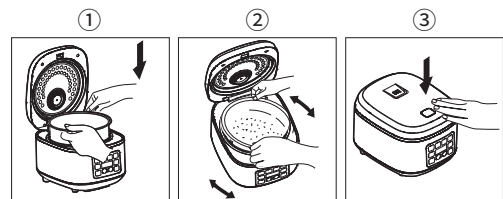

## 5 Connect the plugs

- Plug in the instrument plug, then the power plug, and make sure both are connected securely.

### Attention

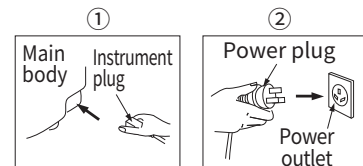

- When cooking with the steaming basket, the maximum cooking capacity is: 1.5 L Model: 4 cups; 1.8 L Model: 5 cups.

# Menu Functions White Rice/Brown Rice/Congee/Soup/Keep Warm

When cooking with the "White Rice" function

**1** Turn on power, and then press  key to select "White Rice" function.

**2** Press  key to start cooking.

- The "White Rice" and "Start" indicators light up.
- Under the "White Rice" function, the remaining cooking time is displayed.
- After entering the cooking stage, the remaining cooking time displayed will be automatically adjusted depending on the rice volume. For example, it may sometimes drop from "After 15 minutes" to "After 11 minutes", rather than decreasing in units of 1 minute.



**3** When cooking is over, loosen the rice.



- After the buzzer rings, cooking has finished. The function will automatically change to keep warm status. To prevent the rice from sticking together, please loosen the rice after cooking.
- Depending on ingredients, you can press  key to cancel keep warm.

■ **Please note**

- Do not mix brown rice with white rice, as this may affect the cooking result.
- With "White Rice" function, you can make rice softer and more delicious.

When cooking with the "Congee/Soup" function

**1** Turn on power, and then press  key to select "Congee/Soup" function.

**2** Press   key to set the cooking time (the initial cooking time is 1 hour and 30 minutes).

- The "Congee/Soup", "Timer" and "Start" indicators flash.
- The range of cooking time: 1 - 4 hours.
- The "hr" key increases time in units of 1 hour.
- The "min" key increases time in units of 10 minutes.



**3** Press  key to start cooking.

- During the cooking process, "Congee/Soup" and "Start" indicators light up.
- Under the "Congee/Soup" function, the remaining cooking time is displayed.

**4** Cooking is over.

- After the buzzer rings, cooking has finished. The function will automatically change to keep warm status. The "Keep Warm" indicator lights up.
- Depending on ingredients, you can press  key to cancel keep warm.

## Keep Warm

- If keeping warm for longer than 24 hours, the "Keep Warm" function will automatically stop, and the display will show "----".
- Cooked rice should be consumed within 5 hours of keeping warm to avoid discoloration or becoming stale.
- When in keep warm function, there may be some droplets at the edge of the pan.
- The rice taste may be affected if the rice scoop is left in the pan when the rice is in keep warm function.

■ **Please note**

- For keeping a small amount of cooked rice warm, stack the cooked rice in the middle of the pan as much as possible to prevent the rice from drying or becoming hard.
- When keeping warm, also always stir the cooked rice to keep the deliciousness unchanged.

# Menu Functions

## Quick Cook/Steam/Timer

When cooking with the "Quick Cook/Steam" function

**1** Turn on power, and then press  key to select "Quick Cook/Steam" function.

**2** Press  key to start cooking.

- During the cooking process, the "Quick Cook/Steam" and "Start" indicators light up.
- Under the "Quick Cook/Steam" function, the remaining cooking time is displayed.

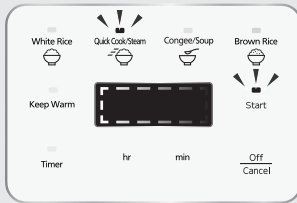

**Table for Steaming Time and Water Quantity**

| Water quantity (approx.) | 1/2 Measuring cup | 1 Measuring cup | 2 Measuring cups | 3 Measuring cups |
|--------------------------|-------------------|-----------------|------------------|------------------|
| Steaming time (approx.)  | 15 minutes        | 30 minutes      | 50 minutes       | 65 minutes       |

\*The maximum time for steaming is about 80 minutes. When the time is up, whether water is completely evaporated or not, the appliance will change to keep warm function automatically.

**3** Cooking is over.

- After the buzzer rings, cooking has finished, and the function will automatically change to keep warm status. The "Keep Warm" indicator remains on.
- Depending on ingredients, you can press  key to cancel keep warm.

### ■ Please note

- "Quick Cook/Steam" can be used for cooking rice. As the cooking time is shortened, the rice may be harder or there may be rice crust.  
→Soak the rice in water in advance, and you can make the cooked rice become softer.

When cooking with the "Timer" function



**1** Turn on power, and then select the desired function, such as "White Rice" function.

- Set the cooking time first when you preset "Congee/Soup" function.

**2** Press  key  
(The initial timer is 5 hours).

- The "White Rice" and "Start" indicators flash, and the "Timer" indicator lights up.



**3** Press   key to set the preset time.

- The "hr" key increases time in units of 1 hour.
- The "min" key increases time in units of 10 minutes.
- The range of the timer: 1 - 24 hours.
- Press and hold "hr" or "min" key to adjust the time quickly.

**4** Press  key, and the timer is set successfully.

- During the cooking process, "White Rice" and "Timer" indicators light up.

### ■ Special notes

- Time indicated by the timer is the length of cooking time.  
(For example, if the timer is 5 hours, it means that cooking finishes after 5 hours.)

### ◆ Function Tips

- After the appliance is powered on, you will hear one "beep", all the indicators on the display light up at once, and then it goes into standby state.
- When it starts cooking, you can stop cooking and return it to standby state by simply pressing [Off/Cancel] key.
- When you select a cooking menu, but do not press [Start] key to start cooking, then the appliance will automatically return to standby state after one minute.



# Cleaning and Maintenance

## Attention

- Before cleaning, pull out the power plug first. Do not clean the main body until it cools down.
- When cleaning the main body, do not immerse it in water, or clean it with lacquer thinner, gasoline, alcohol, cleaning powder or hard brushes, etc.
- Do not use a dishwasher or dish dryer.

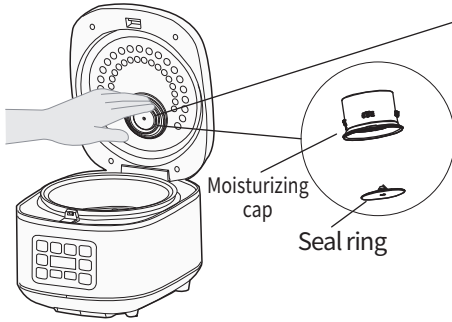

## Moisturizing cap

The moisturizing cap can be taken off directly. Clean it after each use.

### ■ Disassembly

- ① Remove from the heating plate
- ② Separate with a light pull

### ■ Installation

- ① Align into the correct position
- ② Press into the heating plate in the opposite direction of removing. (Please note that it should be installed in place and without a tilt.)

### Caution

- After use, remove the moisturizing cap and put it in warm water for a few minutes, and then rinse with water.
- After cleaning, do not dry it with a dishwasher etc; otherwise deformation or cracks may be caused.

## Main body · Outer lid · Heating plate · Pan seal ring

Wipe with a damp cloth.

- If oil stains are not removed, any oil stains on the outer lid may stick to it and become difficult to remove. Clean the outer lid after each use.
- As the metal parts are heated, there may be color changes or stripes on their surfaces, which will not affect their normal functions.
- Do not pull the pan seal ring.

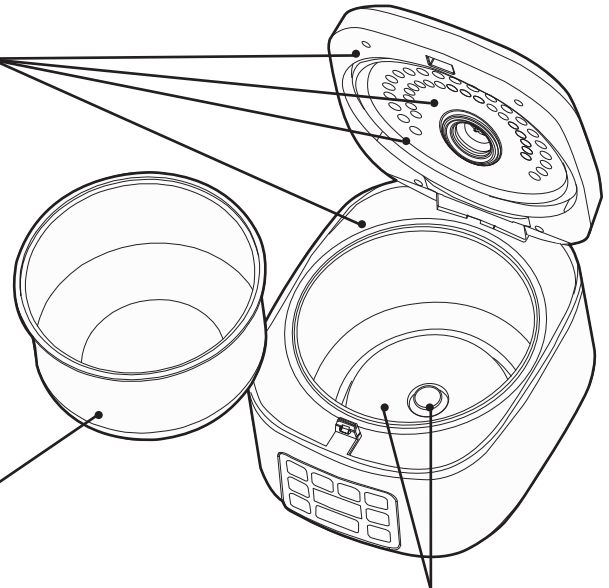

## Pan

- Clean with diluted detergent, a soft sponge and water. Wipe off any water on the outside of the pan.
- Do not use the pan as a container for cleaning.
- Color changes or stripes may appear on the non-stick coating surface, which will not affect human health or normal bodily functions.
- Depending on the frequency of use, rubbing traces may appear on the outside of the pan, which will not affect the performance of the appliance.

## Cast heater/Bottom sensor

Wipe with a damp towel.

- When adhesion is present, wipe with fine sandpaper (around No.600) or a dry cloth.

### Notes

- If you do not clean the bottom sensor and cast heater, the rice may be burned or boiled badly.

# Troubleshooting

Please check before requesting a repair.

| Scenario   | Possible Cause   |
|--|--|
| Does not cook during preset time                         | <ul style="list-style-type: none"><li>• Check if the [Start] key has been pressed.</li></ul>   |
| Cooking time is long                                     | <ul style="list-style-type: none"><li>• If cooking is done continuously, the cooking time will be longer (by up to 30 minutes).</li><li>• Due to the different amounts of rice and water, the remaining time displayed may be stopped for adjustment in the middle of cooking.</li></ul>                                     |
| Cooking time is short                                    | <ul style="list-style-type: none"><li>• Due to the different amounts of rice and water, the remaining time displayed may be adjusted in the middle of cooking.</li></ul>   |
| Steam vapor leaks from places other than from steam vent | <ul style="list-style-type: none"><li>• A foreign object may be attached to the pan seal ring or along the pan.</li><li>• The pan may be deformed.</li></ul>   |
| Key operation can not be performed                       | <ul style="list-style-type: none"><li>• Check if the lights above the keys are on.<br/>→Key operation can not be performed during cooking, while using the timer, or when using the "Keep Warm" function. Press the [Off/Cancel] key before operation.</li></ul>   |
| Sparks occur from the power plug                         | <ul style="list-style-type: none"><li>• When plugging in or pulling out the power plug, small sparks may sometimes be seen. This is not a malfunction.</li></ul>   |
| There is a plastic smell                                 | <ul style="list-style-type: none"><li>• There may be a plastic smell at the beginning of use. This will be eliminated after several more uses. It is not abnormal.</li></ul>   |
| The appliance makes a noise                              | <ul style="list-style-type: none"><li>• The sound of "click, click" in cooking is the sound of the power adjusting, which is not a fault.</li><li>• The "pa" sound in cooking is the cracking sound generated by the thermal expansion of water droplets at the bottom (outside) of the pan, which is not a fault.</li></ul> |
| Cooking ends early in timer mode                         | <ul style="list-style-type: none"><li>• When using the timer function, due to the different amounts of rice and water, the remaining time displayed may be adjusted in the middle of cooking or finish early.</li></ul>  |

## Attention

- If water and rice are accidentally put into the main body without the pan, please contact a Panasonic authorized service center for assistance..

# Troubleshooting

Please check before requesting a repair if it is not a failure.

| Scenario   | Possible Cause  |
|--|---|
| Rice is glutinous (soft)                                 | <ul style="list-style-type: none"><li>• Rice quantity and water volume may be incorrect.</li><li>• There may be broken rice mixed in.</li><li>• The rice may have been immersed in water for a long time (e.g. preset time is too long, etc.).<br/>→When using the timer function to cook, you need to put less water.</li><li>• Hot water was used to wash the rice.</li><li>• The rice was not loosened immediately after cooking.</li><li>• Too much water was added into new rice for cooking.</li></ul>  |
| Rice is hard   | <ul style="list-style-type: none"><li>• The rice amount and water volume may be incorrect.</li><li>• The "Quick Cook/Steam" function was used for cooking.</li></ul>  |
| Congee is mushy  | <ul style="list-style-type: none"><li>• The rice was soaked in water for a long time while using the cooking timer function.</li><li>• The "Keep Warm" function has been used.</li><li>• There is too much broken rice.</li></ul>   |
| Rice is scorched   | <ul style="list-style-type: none"><li>• Rice was not washed adequately.</li><li>• A foreign object is attached to the bottom of the pan, on the bottom sensor, or on the cast heater.</li><li>• The cooking timer hasn't been set.</li><li>• Broken rice has been mixed in.</li><li>• Spices have been added for cooking.</li><li>• The bottom of the pan is uneven.</li><li>• The moisturizing cap is mounted incorrectly.</li></ul>   |
| There is condensation<br>There is odor<br>Rice is yellow | <ul style="list-style-type: none"><li>• Rice has not been loosened immediately after cooking.</li><li>• The "Keep Warm" function has been used for longer than 5 hours.</li><li>• Cooled rice has been added into the pan and the "Keep Warm" function has been used.</li><li>• The rice scoop has been left in the pan while using the "Keep Warm" function.</li><li>• Different types of rice or water quality may cause cooked rice to be yellowish in colour.</li><li>• If seasonings are used during cooking, you may notice a smell. Carefully clean the pan, heating plate and moisturizing cap after use.</li></ul> |
| Rice is dry  | <ul style="list-style-type: none"><li>• The "Keep Warm" function is used for longer than 5 hours.</li><li>• Rice is reheated several times.</li><li>• The moisturizing cap is not mounted correctly.</li><li>• A foreign object is attached to the pan seal ring or along the pan.</li><li>• The pan is deformed.</li></ul>   |
| Rice sticks onto the pan                                 | <ul style="list-style-type: none"><li>• Due to the different varieties of rice, soft rice might easily stick to the pan.</li></ul>  |
| A thin film is formed                                    | <ul style="list-style-type: none"><li>• A paper-like film is the result of dry starch dissolution, and it is harmless. If rice is not washed sufficiently prior to cooking, such a film may form.</li></ul>   |
| Cooked rice has bumpy surface                            | <ul style="list-style-type: none"><li>• Under the following circumstances, rice tends to have an uneven surface:<ul style="list-style-type: none"><li>• When rice has not been sufficiently washed.</li><li>• When a lot of broken rice is mixed in.</li><li>• When rice has been broken due to excessive force used to wash it.</li></ul></li></ul>  |

# Error Codes Indication

Please check before requesting a repair.

## Error display

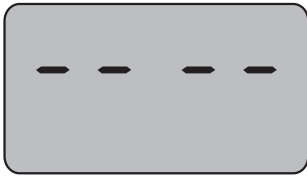

## Please check

- Was the "Keep Warm" duration set to more than 24 hours?
- After keeping warm for 24 consecutive hours, the "Keep Warm" function will automatically stop, and the display will show  as it goes into standby state.



- Is the appliance cooking with nothing inside?  
→Unplug the power plug, and try again after the main body cools down completely.

If the appliance is still not back to normal after the above is confirmed, contact a Panasonic authorized service center for repair.

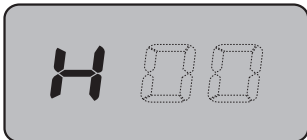

- Unplug the power plug and plug it in again.  
If "H※※" still appears, then there is a fault.  
→Please consult a Panasonic authorized service center, and advise what the error code says (two digits after "H").

# Specifications

| Model No.                                       |                  | SR-DA152            | SR-DA182          |
|---|------------------|---------------------|-------------------|
| Rated Voltage                                   |                  | 230 V - 240 V~      |                   |
| Rated frequency                                 |                  | 50 Hz               |                   |
| Rated power input                               |                  | 770 W               |                   |
| Nominal volume of the pan (Approx.) L           |                  | 1.5                 | 1.8               |
| Cooking quantity<br>(Rice) L (cup)              | White Rice       | 0.18-1.44 [1-8]     | 0.18-1.8 [1-10]   |
|   | Quick Cook/Steam | 0.18-1.44 [1-8]     |                   |
|   | Brown Rice       | 0.18-1.08 [1-6]     |                   |
| Congee cooking volume (Rice) L (cup)            |                  | 0.09-0.27 [0.5-1.5] | 0.09-0.36 [0.5-2] |
| Maximum cooking volume (Ingredients + Water) L* |                  | 2                   | 2.5               |
| Power cord length (Approx.) m                   |                  | 1                   |                   |
| Weight (Approx.) kg                             |                  | 2.8                 | 3.0               |
| Size (Approx.) mm                               | Depth            | 266                 |                   |
|   | Width            | 337                 |                   |
|   | Height           | 210                 | 229               |

(※) Indicates the cooking capacity at the Maximum waterline of "Congee".

# Panasonic Warranty

## Small Kitchen Appliances 12 Month Warranty from Date of Purchase ("Warranty Period")

Microwave Oven, Rice Cooker, Bread Maker, Benchtop Oven and Stick Blenders

1. This warranty does not exclude, restrict or modify in any way other rights and remedies under the law which relates to the product, including any non-excludable statutory guarantees in Australia.
2. Subject to the conditions of this warranty and during the Warranty Period, Panasonic or its Authorised Service Centre will perform the necessary service on the product without charge for parts or labour, if in the opinion of Panasonic, the product is found to be faulty within the Warranty Period.
3. This warranty only applies to Panasonic products purchased in Australia and sold by Panasonic Australia or its Authorised Distributors or Dealers and only where the products are used and serviced within Australia or its territories. Warranty cover only applies to service carried out by a Panasonic Authorised Service Centre and only if valid proof of purchase is presented when warranty service is requested.
4. This warranty only applies if the product has been used in accordance with the manufacturer's recommendations (as noted in the Operating Instructions) under normal use and reasonable care (in the opinion of Panasonic). The warranty covers normal domestic use only and does not cover damage, malfunction or failure resulting from:
  - (a) misuse, abuse, neglect, accidental damage or modifications;
  - (b) infestation by insects or vermin;
  - (c) incorrect installation, assembly, improper voltage, or mains supply problems;
  - (d) natural disaster or acts of God (e.g. lightning, flood, fire, earthquakes etc);
  - (e) rust or damage caused by exposure to abnormally corrosive conditions;
  - (f) an accessory, component or other equipment not supplied by Panasonic Australia;
  - (g) improper maintenance by the customer (refer to the maintenance section of the Operating Instructions) which includes but is not limited to the failure to undertake the following actions:
    - (i) regular cleaning; and
    - (ii) where filters are included, regular cleaning and replacement of filters where necessary.
  - (h) incorrect operation of the product; and
  - (i) where no actual fault of the product is determined to have occurred, during a customer-initiated service call, and where the perceived problem is explained within the Operating Instructions (including the trouble-shooting section) warranty service is not applicable
5. This warranty does not cover the following items unless the fault or defect existed at the time of purchase:
  - (a) Cabinet or Casing Parts
  - (b) Noise or vibration that is considered normal
  - (c) User replaceable Batteries
  - (d) Kneader mounting shaft unit and heads, blades and other accessories
  - (e) Microwave Oven cook plates
6. You will be responsible for costs associated with making the warranty claim where there are costs associated with shipping or handling or travelling outside of the area normally serviced by Panasonic or any repair agent authorised by Panasonic.
7. To the extent permitted by law and subject to your non-excludable statutory rights and guarantees, Panasonic excludes all warranties and liabilities (other than those contained in this warranty) including any liability for loss or damage whether direct or indirect arising from your purchase, use or non-use of the product.
8. In addition to your rights under this warranty, Panasonic products come with consumer guarantees that cannot be excluded under the Australian Consumer Law. You are entitled to a replacement or refund for a major failure and compensation for any reasonably foreseeable loss or damage. You are also entitled to have the product repaired or replaced if the product fails to be of an acceptable quality and the failure does not amount to a major failure.
9. To claim warranty service, when required, you should:
  - Contact Panasonic's Customer Care Centre on 132 600 for Authorised Service Centre information
  - Send or take the product to a Panasonic Authorised Service Centre together with your purchase receipt as a proof of purchase date.

**THIS WARRANTY CARD AND THE PURCHASE DOCKET (OR SIMILAR PROOF OF PURCHASE) SHOULD BE RETAINED BY THE CUSTOMER AT ALL TIMES**

If you require assistance regarding warranty conditions or any other enquiries, please visit the **Panasonic Australia** website [www.panasonic.com.au](http://www.panasonic.com.au) or contact by phone on **132 600**  
*If phoning in, please ensure you have your operating instructions available.*

**Panasonic Australia Pty. Limited**

ACN 001 592 187 ABN 83 001 592 187

1 Innovation Road, Macquarie Park NSW 2113

[www.panasonic.com.au](http://www.panasonic.com.au)

PRO-031-F01 Issue: 2.0

09-12-2021

# Panasonic Warranty

## Home Appliance 24 Month Warranty from Date of Purchase

1. Subject to the conditions of this warranty Panasonic or it's Authorised Service Centre will perform necessary service on the product without charge for parts or labour, if in the opinion of Panasonic, the product is found to be faulty within the warranty period. For Line Communications products (i.e. Cordless Phones, etc) the genuine battery(s) has a 3 month warranty.
2. This warranty only applies to Panasonic products purchased in New Zealand and sold by Panasonic New Zealand or its Authorised Distributors or Dealers and only where the products are used and serviced within New Zealand or it's territories. Warranty cover only applies to service carried out by a Panasonic Authorised Service Centre and only if valid proof of purchase is presented when warranty service is requested.
3. This warranty only applies if the product has been installed and used in accordance with the manufacturer's recommendations (as noted in the operating instructions) under normal use and reasonable care (in the opinion of Panasonic). The warranty covers normal domestic use only (also Clip & Trim Professional use) and does not cover damage, malfunction or failure resulting from use of incorrect voltages, incorrect installation, accident, misuse, neglect, build-up of dirt or dust, abuse, maladjustment of customer controls, mains supply problems, thunderstorm activity, infestation by insects or vermin, tampering or repair by unauthorised persons (including unauthorised alterations), exposure to abnormally corrosive conditions or any foreign object or matter having entered the product.
4. This warranty does not cover the following items unless the fault or defect existed at the time of purchase:
  - (a) Cabinet Parts
  - (b) Microwave Oven cook plates.
  - (c) User replaceable Batteries
  - (d) Kneader mounting shaft unit and Heads, Cutters, Foils, Blades and other accessories.
  - (e) Noise or vibration that is considered normal
  - (f) Wear and tear from normal use
5. To claim warranty service, when required, you should:
  - Telephone Panasonic's Customer Care Centre on 09 2720178 or visit our website referred to below and use the Service Centre Locator for the name/address of the nearest Authorised Service Centre.
  - Send or take the product to a Panasonic Authorised Service Centre together with your proof of purchase receipt as a proof of purchase date. Please note that freight and insurance to and / or from your nearest Authorised Service Centre must be arranged by you.
6. The warranties hereby conferred do not extend to, and exclude, any costs associated with the installation, de-installation or re-installation of a product, including costs related to the mounting, de-mounting or remounting of any screen, (and any other ancillary activities), delivery, handling, freighting, transportation or insurance of the product or any part thereof or replacement of and do not extend to, and exclude, any damage or loss occurring by reason of, during, associated with, or related to such installation, de-installation, re-installation or transit.

Panasonic Authorised Service Centres are located in major metropolitan areas and most regional centres of New Zealand, however, coverage will vary dependant on product. For advice on exact Authorised Service Centre locations for your product, please telephone our Customer Care Centre on 09 2720178 or visit our website and use the Service Centre Locator.

Unless otherwise specified to the consumer the benefits conferred by this express warranty are additional to all other conditions, warranties, guarantees, rights and remedies expressed or implied by the Consumer Guarantees Act of New Zealand and all other obligations and liabilities on the part of the manufacturer or supplier and nothing contained herein shall restrict or modify such rights, remedies, obligations and liabilities.

**THIS WARRANTY CARD AND THE PURCHASE DOCKET (OR SIMILAR PROOF OF PURCHASE) SHOULD BE RETAINED BY THE CUSTOMER AT ALL TIMES**

If you require assistance regarding warranty conditions or any other enquiries, please visit the **Panasonic New Zealand** website **[www.panasonic.co.nz](http://www.panasonic.co.nz)** or contact by phone on **09 2720178**  
*If phoning in, please ensure you have your operating instructions available.*

**Panasonic New Zealand Customer Care Centre**

**Phone: 09 2720178**

**Fax: 09 2720129**

**Email: [customerservice@nz.panasonic.com](mailto:customerservice@nz.panasonic.com)**

**Website: [www.panasonic.co.nz/support](http://www.panasonic.co.nz/support)**

