

Panasonic®

USER'S MANUAL WLAN Adaptor

Model No. **CZ-CAPWFC1**

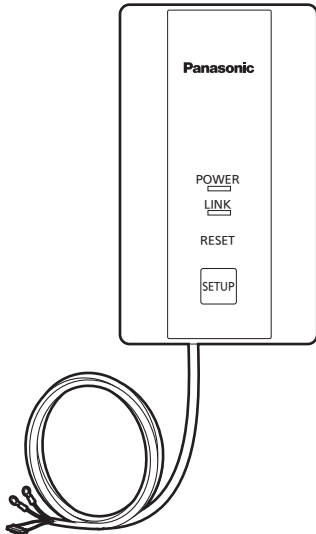

Contents

Safety Precautions	2
System Overview.....	5
Parts Identification	6
Parts.....	7
Dimensions	7
WLAN Adaptor Installation	8
Connecting Network.....	11
Use the “Panasonic Comfort Cloud”	18
WLAN Adaptor Q & A	27
Firmware Update Function	29
Software License Information	29
Specifications	36



Thank you for purchasing this Panasonic product.
Please read these instructions carefully before using this product, and save this manual for future use.



Panasonic Corporation
1006 Kadoma, Kadoma City, Osaka, Japan

Panasonic Corporation
<http://www.panasonic.com>

F1218-20119
ACXF60-34442

Please Read Before Starting

These instructions are all you need for most installation sites and maintenance conditions. If you require help for a special problem, contact our sales/service outlet or your certified dealer for additional instructions.

The English text are the original instructions. Other languages are translations of the original instructions.

Safety Precautions

We assume no responsibility for accidents or damages resulting from methods other than those described in the USER'S MANUAL or methods without using specified parts. Malfunctions that occur due to the unauthorised installation methods are not covered by the product warranty.

- This WLAN Adaptor shall be installed in accordance with National Wiring Regulations.
- Read the installation instructions of devices to be connected as well.
- When relocating or repairing this WLAN Adaptor, provide the USER'S MANUAL to the servicing personnel.
- Please provide this USER'S MANUAL to the user after installation.
Instruct user to keep it in a safe place along with the air conditioner instruction manuals.



WARNING

This symbol refers to a hazard or unsafe practice which can result in severe personal injury or death.



CAUTION

This symbol refers to a hazard or unsafe practice which can result in personal injury or product or property damage.

Precautions for Installation setup and WLAN Adaptor



WARNING

- Turn off the circuit breaker of the units before installation.
- Select an installation location which is rigid and strong enough to support or hold the WLAN Adaptor, and select a location for easy maintenance.
- Use only the parts specified by Panasonic as supplied accessories.
- Ensure cables are installed properly so that external forces cannot affect them.
- Disassembly and modification of the WLAN Adaptor is not permitted under any circumstances.



WARNING

- The WLAN Adaptor must be installed by the sales dealer or installer.
- When installing the WLAN Adaptor, use appropriate protective equipment and tools for safety.
- The WLAN Adaptor should be securely installed in accordance with the USER'S MANUAL.
- Electric work must be performed by authorised personnel in accordance with the local regulations and the instructions detailed in the USER'S MANUAL.
- To avoid malfunctions caused by radio wave interference, keep the WLAN Adaptor away from devices such as other wireless device, microwaves and the device that use 2.4 GHz signal. Depending on the area, the module may not be available.
- Attach the electrical cover to the indoor unit securely.
- Make sure to connect the WLAN Adaptor to the P.C. board and terminal board of the indoor unit properly.
- Do not set up in hospitals or places where electronic medical devices are located.
- If you have a cardiac pacemaker or implantable cardioverter defibrillator, please keep at least 15 cm away from the WLAN Adaptor.
- Do not use the WLAN Adaptor near to automatic control equipment (automatic door, fire alarms, etc.).
- In case of an abnormal condition (such as a burning smell), stop the indoor unit and turn the breaker OFF.
- Do not operate with wet hands.
- Do not splash water on the WLAN Adaptor or use it in the bathroom.



CAUTION

- Ground yourself to discharge static electricity before performing any wiring.
- Do not install the WLAN Adaptor in places with direct sunlight or where the ambient temperature is 55 °C or more or is 0 °C or less.
- The connecting cable must not touch piping directly.
- Do not set up where children can reach the WLAN Adaptor.
- Do not stand on an unstable surface when operating or checking the WLAN Adaptor.
- Do not use in special environments.
Use in places with much oil (including machine oil), steam, flammable or corrosive gas, voltage fluctuation, surrounding the metal body, may lead to severe decrease in functionality and damage to parts.
- Do not use the WLAN Adaptor nearby other wireless devices, microwaves, cordless phones, or facsimiles.
- This equipment is not suitable for use in locations where children are likely to be present.
- This appliance is not intended for use by persons (including children) with reduced physical, sensory or mental capabilities, or lack of experience and knowledge, unless they have been given supervision or instruction concerning use of the appliance by a person responsible for their safety. Children should be supervised to ensure that they do not play with the appliance.
<for European market only>
This appliance can be used by children aged from 8 years and above and persons with reduced physical, sensory or mental capabilities or lack of experience and knowledge if they have been given supervision or instruction concerning use of the appliance in a safe way and understand the hazards involved. Children shall not play with the appliance. Cleaning and user maintenance shall not be made by children without supervision.

NOTE

- Install the WLAN Adaptor vertically or horizontally.
- When attaching the WLAN Adaptor, be sure to use the supplied screws and confirm that the WLAN Adaptor is fixed to the surface so that there are no gaps.
- The warranty does not cover the product if it falls from an elevated location.
- The WLAN coverage must include the air conditioner installation location.
- Please write down the model information and more on the last page “Setting Information”, when you install the WLAN Adaptor.
- Requires a smartphone or tablet that is iOS/Android compatible.
- Please ensure that the Router supports the WPA2-PSK (TKIP/AES) encryption setting before commencement of the installation of this WLAN Adaptor.
- To complete connection of this WLAN Adaptor to the wireless network service the Router may be required.
- The End user should read and accept the Terms of use and Privacy Notice in the contents of “Panasonic Comfort Cloud” app.
- Please avoid to set up multiple WLAN Adaptor registrations at the same time.
- There is a risk of unauthorised operation if a vulnerable password is set for the wireless router.
- Users are responsible for all costs associated with downloading and using the Comfort Cloud App and WLAN Adaptor, including without limitation all fees charged by your Device carrier and internet service provider and any other WLAN or data access charges.
- Panasonic WLAN Adaptor is designed for communication to the “Panasonic Comfort Cloud”.
- Third party WLAN interfaces cannot be connected to the “Panasonic Comfort Cloud”.
- Updates to the service may mean there are changes to the design of the “Panasonic Comfort Cloud” app screen and display.

System Overview

Indoor unit (example: 4-way cassette)

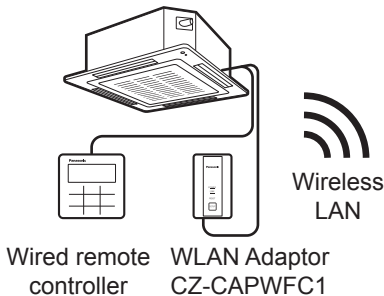

Router

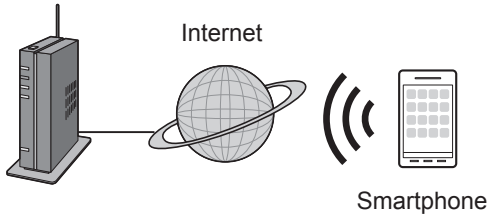

Parts Identification

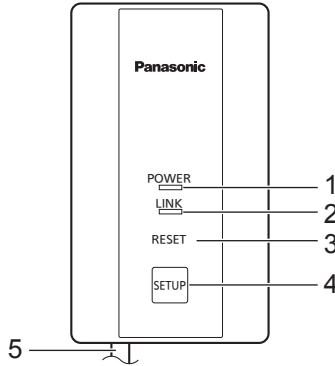



No	Item	Description
1	POWER LED (green)	<p>Indicates that the WLAN Adaptor is being supplied with power.</p> <p>On : Power being supplied Off : No power being supplied</p>
2	LINK LED (green)	<p>Indicates the communication status of the WLAN Adaptor to the router.</p> <p>Off : Not connected to router Blinks : In the process of connecting with router On : Connected to router</p> <p>The LINK LED does not light if the WLAN Adaptor cannot connect with a router.</p> <p>The following are cases with special LED indications.</p> <ul style="list-style-type: none"> When SETUP button is pressed and held The LED blinks to indicate how much time has elapsed. Blinks once after 5 seconds have elapsed Blinks twice after 10 seconds have elapsed Blinks three times after 15 seconds have elapsed Blinks four times after 20 seconds have elapsed Blinks five times after 25 seconds have elapsed Blinks six times after 30 seconds have elapsed Lights constantly after 35 seconds have elapsed When operating in WPS mode Blinks at 1.0-second intervals When operating in AP mode Blinks at 0.5-second intervals

No	Item	Description
3	RESET button*	Resetting the hardware Use to restart the WLAN Adaptor.
4	SETUP button*	Used when making network settings. Refer to “Connecting Network” (Page 11) for details.
5	Communication lines (L=1.9 m)	These are the communication lines connecting the indoor units and the WLAN Adaptor. Refer to “WLAN Adaptor Installation” (Pages 8, 9) for details.

* Initialising the WLAN Adaptor

Press and hold the SETUP button (30 to 35 seconds). After this, press the RESET button within 5 seconds to initialise.

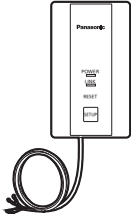
Parts

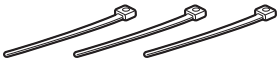
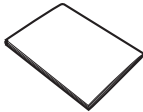
Adaptor Unit (1) (CZ-CAPWFC1) 	Screw (2)  M3.8 x 16
Clamper (3) 	USER'S MANUAL (1) 

Dimensions

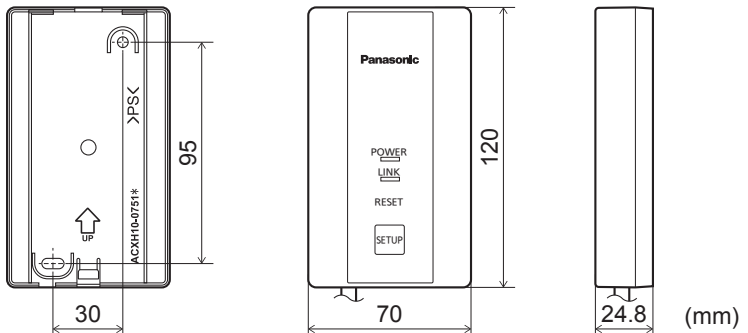

WLAN Adaptor Installation

Basic Wiring Diagram

Irrespective of the number of indoor units, the WLAN Adaptor must be used together with a remote controller.

A remote controller must be connected and it should be set as the “main unit” in the main-sub remote controller settings.

- Refer to the remote controller installation instructions for details on how to make the main-sub settings for the remote controller.
- Total length of remote controller wiring: Within 500 m
(Remote controller wiring between indoor units is within 200 m)
- Number of units that can be connected for group control
 - Indoor units : Up to 8 units
 - WLAN Adaptor : 1 unit
 - Wired remote controller : 1 unit
- The system operates irrespective of the indoor unit you choose to connect the WLAN Adaptor and remote controller to.

■ When there is 1 indoor unit

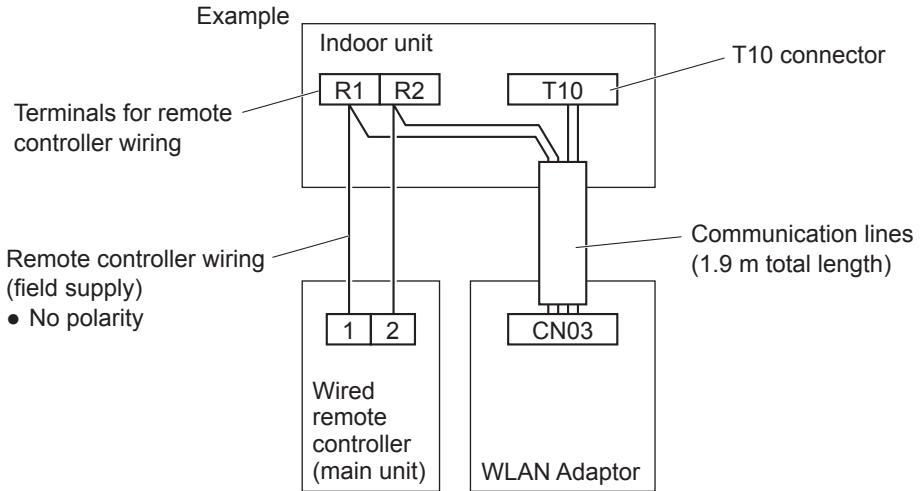

■ When there are multiple indoor units

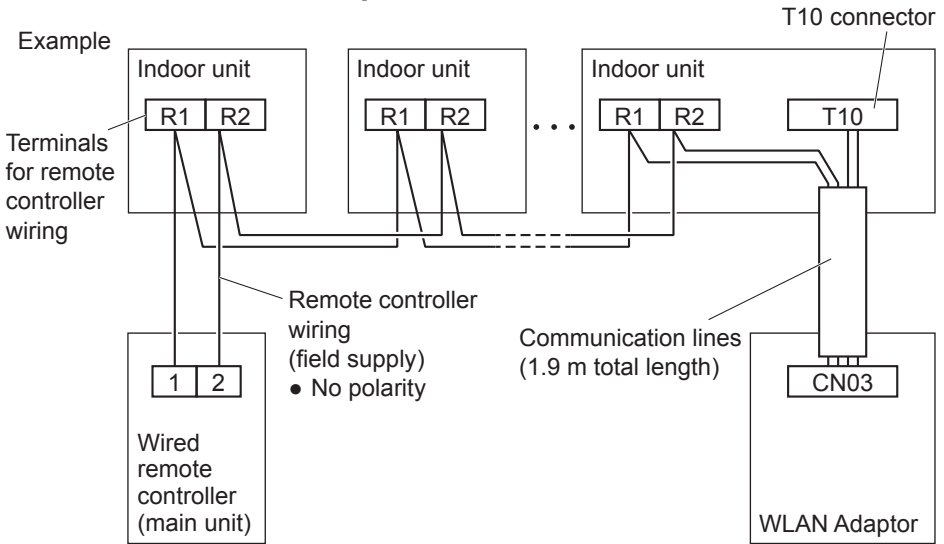

Example of standard installation

1 Connect the communication lines to the indoor unit.

Example: With a 4-way cassette indoor unit

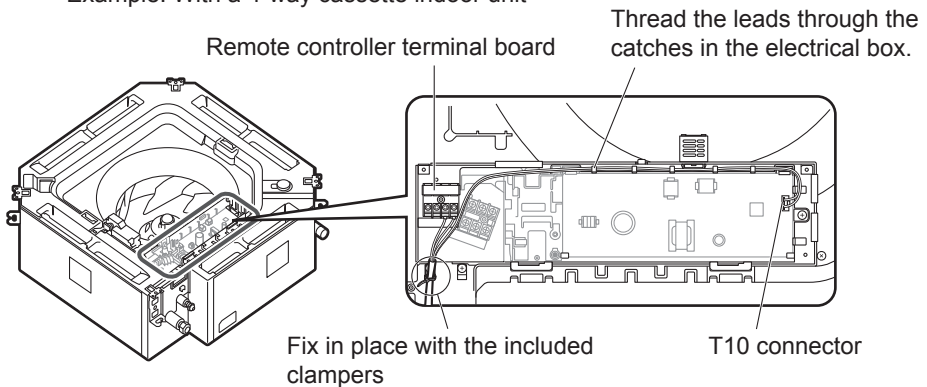

- Fix the communication lines in place with the included clampers*.
* Make sure the clampers hold the parts coated in white.
- Lead wires* with crimp terminals should be connected to the remote controller terminal board. Lead wires* with connectors should be connected to the T10 connector.
* There may be left over lead wires depending on the type of indoor unit. Tie back left over lead wires with the included clampers.
* The lead wires with crimp terminals have no polarity.

2 Remove the top case.

Use a flat head screwdriver or similar tool to push in the catch on the bottom case and remove the top case. Take care not to break the catch when pushing with the screwdriver.

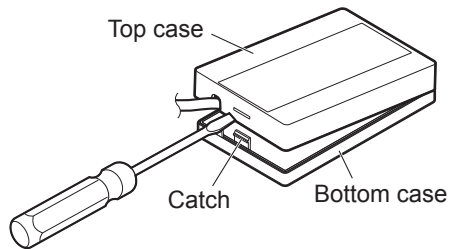

3 When attaching the bottom case to the wall

Screws (supplied): 2

Attach the WLAN Adaptor to the wall with the UP mark facing upwards.

Please ensure screws are tightened firmly. Do not overtighten screws as this may damage the casing.

Ensure that the screws do not contact metallic parts within the wall.

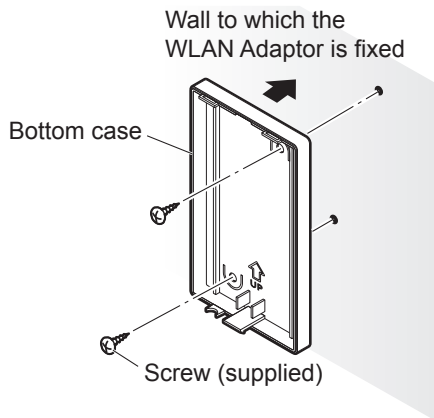

4 Attach the top case.

Fit the upper catches before fitting the lower catch.

Take care not to pinch the communication lines in the case.

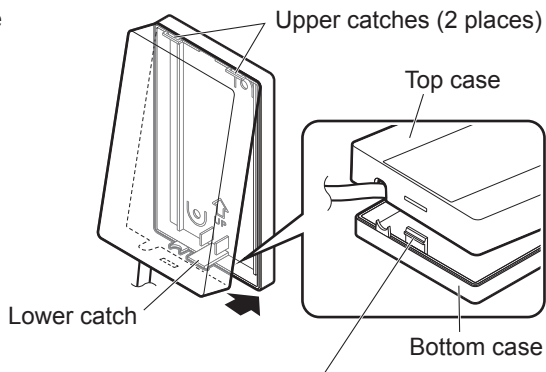

When fitting the lower catch, press down on it with a flat head screwdriver or similar tool and then fit the top case onto it.

* Note that applying too much pressure to the flat head screwdriver may result in damage to the catch.

Connecting Network

Establish network connection to the internet via Wireless mode.

1 Turn on the power supply to the indoor unit.

- The POWER LED will be lit (green).
- The LINK LED will not be lit.

<Note>

- It will not be possible to make network settings for approximately 3 minutes after turning on the power of the WLAN Adaptor due to initial settings being performed.

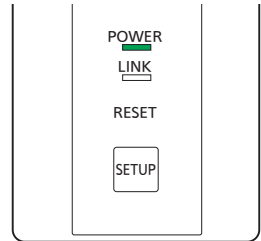

2 App Installation

For iOS user (iOS 9 and above)

- Open  .
- Search for “Panasonic Comfort Cloud” app.
- Download and install.

For Android user (Android 4.4 and above)

- Open  .
- Search for “Panasonic Comfort Cloud” app.
- Download and install.

<Note>

- The app user interface image may change for version upgrade without notification.
- There is no charge for using this application. However, other charges may be incurred for connection and operation.

3 Starting “Panasonic Comfort Cloud”

3.1 Create New Panasonic ID

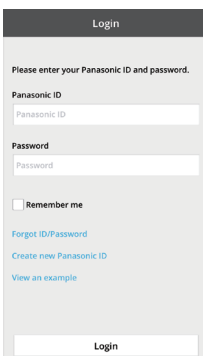

Use “Panasonic Comfort Cloud” app as an option to control the air conditioner.

- For new user, select Create new Panasonic ID to register. Password must be 8-16 characters with letters and numbers.

You can input the following characters. (As of January 2019)

Numeric characters	0123456789
Alphabetical characters (upper and lower cases)	ABCDEFGHIJKLMNOPQRSTUVWXYZabcdefghijklmnopqrstuvwxyz
Symbols	~`!@#\$%^&*()-_+={}[]

- For registered user, login using your Panasonic ID and password.

<Note>

- It is recommended that the password is changed periodically.

3.2 App Setting

Before setting

- Confirm the wireless router is connected to the network and the router has access to the internet.
- Confirm the Wireless LAN of the smartphone is activated.
- Smartphone and air conditioner should be connected to the same wireless LAN.
- Ensure Wireless LAN is broadcasting SSID.

Add new air conditioner device

- The air conditioner needs to be registered before using “Panasonic Comfort Cloud” app.

1. At My Home screen, tap “+” to add new product.



3. Tap “Start” to begin the connection setup.

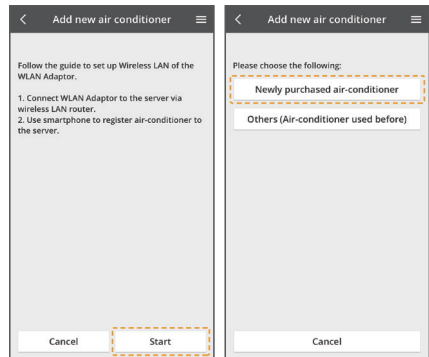

2. Select the “Commercial air conditioner” and choose the “WLAN Adaptor”.

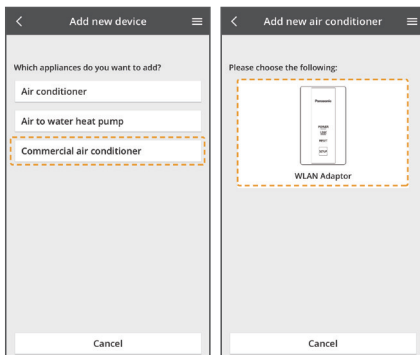

<Note>

The WLAN Adaptor is available for use with all indoor units of commercial air conditioners with names which start with “S-” except S-80/125MW1E5*.

* As of January 2019

Setting connection network

1. Tap “Next” after confirming the POWER LED of the WLAN Adaptor is ON.

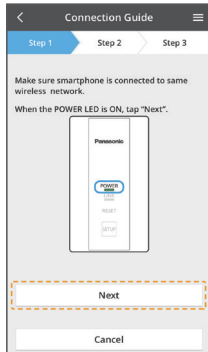

2. Select the option that matches the status of LINK LED.

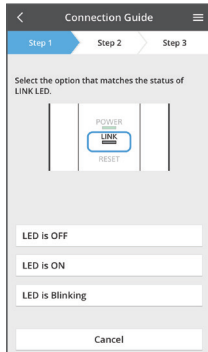

<Note>

- When the “SETUP” button on the WLAN Adaptor can not be operated or when you can not check the LED
 1. Tap “Next”.
 2. Select “LED is OFF”.
 3. Select “Connect with AP mode”.

3. Select the preferred router support connectivity mode.

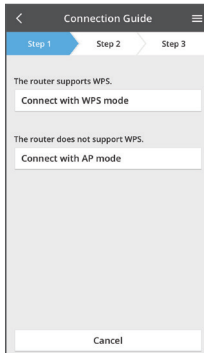

Connection network using WPS mode (method 1)

1. Press the “WPS” button on the router to establish connection.
2. Tap “Next” after the router is ready for connection.

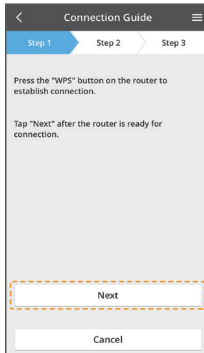

3. Press and hold the "SETUP" button on the WLAN Adaptor for 5 seconds.
4. Release the "SETUP" button on the WLAN Adaptor when the LINK LED blinks once.
5. Tap "Next" when the LINK LED starts to blink continuously.

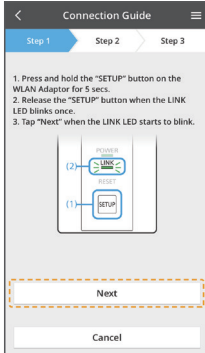

6. When the connection of WLAN Adaptor to router is successful, the LINK LED changes from blinking to ON.

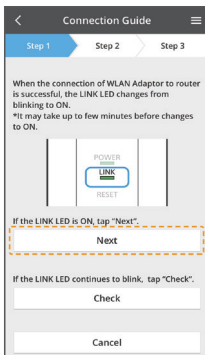

*It may take up to few minutes before changes to ON.

<Note>

- If the LINK LED continues to blink, check the wireless router connection.

Connection network using AP mode (method 2)

1. Press and hold the "SETUP" button on the WLAN Adaptor for 10 seconds.
2. Release the "SETUP" button on the WLAN Adaptor when the LINK LED blinks twice.
3. Tap "Next" when the LINK LED starts to blink continuously.

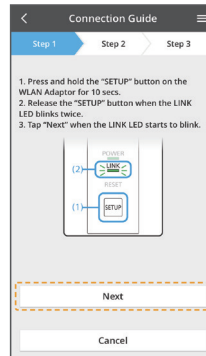

<Note>

- When the "SETUP" button on the WLAN Adaptor can not be operated or when you can not check the LED
 1. Operate the air conditioner with remote controller.
 2. With the remote controller, set the air conditioner to fan mode.
 3. Tap "Next".

4. To change the wireless network connection of the smartphone, tap “To wireless network settings of the smartphone.”. Change the network to the following.
The smartphone will connect to the WLAN Adaptor.

SSID : Panasonic-CZ-C-wirelessAP
Password : Cac8pswa

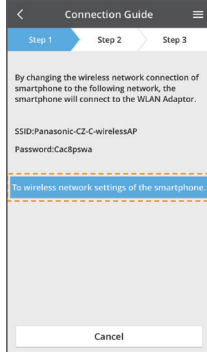

5. A window will prompt, tap “Copy password and next” to proceed to smartphone wireless network setting.

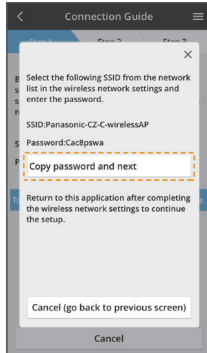

6. Connect to “Panasonic-CZ-C-wirelessAP” network. Once connected, continue with setup in the application.

7. Connect the WLAN Adaptor to wireless router.
Select the SSID of your wireless router.
Enter the password of the selected wireless router.

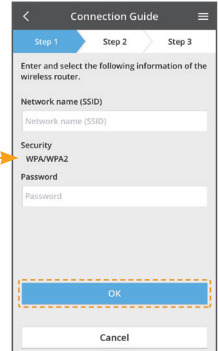
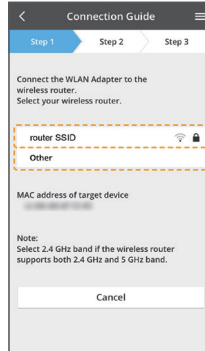

8. When the connection of WLAN Adaptor to router is successful, the LINK LED changes from blinking to ON.

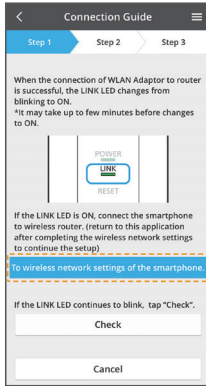

*It may take up to few minutes before changes to ON.

<Note>

- If the LINK LED is ON, connect the smartphone to wireless router. (return to this application after completing the wireless network settings to continue the setup)
- If the LINK LED continues to blink, check the wireless router connection.
- When the “SETUP” button on the WLAN Adaptor can not be operated or when you can not check the LED
 1. Wait one minute.
(waiting for the WLAN Adaptor to be connected to the wireless router)
 2. Tap “To wireless network settings of the smartphone.”.

Select the air conditioner and set the password

1. Select the air conditioner model to register the device.

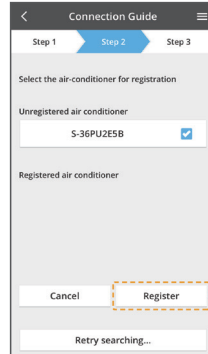

2. Press the “SETUP” button on the WLAN Adaptor.
Tap “Next”.

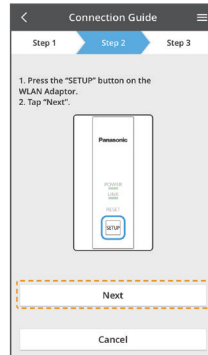

<Note>

- When the “SETUP” button on the WLAN Adaptor can not be operated or when you can not check the LED
 1. With the remote controller, set the air conditioner to fan mode.
 2. Stop the air conditioner with the remote controller.
 3. Tap “Next”.

3. Set a password for new air conditioner model to complete the registration.

Password must be 8-15 characters with letters and numbers.

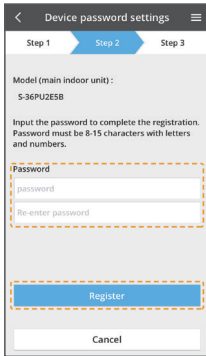

<Note>

- Keep the password for future use with additional user registrations.

Registration completed

Once connection is established between the app and the new air conditioner, set the preferred name for this air conditioner to help identify it.

- By registering the new name of air conditioner, the function of “Panasonic Comfort Cloud” app is ready to be used.

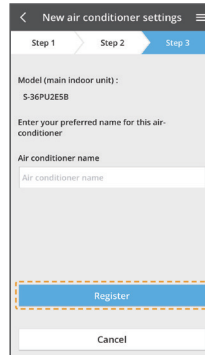

- In addition to operation control, this application can monitor the estimated energy consumption and perform comparisons for different time frames by referring to the statistic's graph.

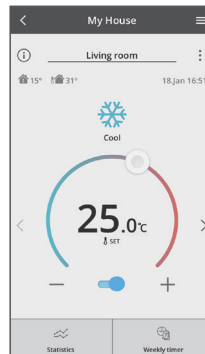

Use the “Panasonic Comfort Cloud”



User’s manual can be found under Menu tab.

The “Panasonic Comfort Cloud” is connected to the WLAN Adaptor and ready for use.

Login

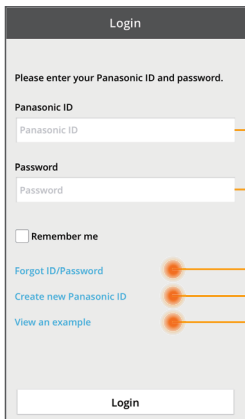

Panasonic ID

Password

Reset Panasonic ID / Password

Register for new Panasonic ID

Start a demonstration

■ Home Screen

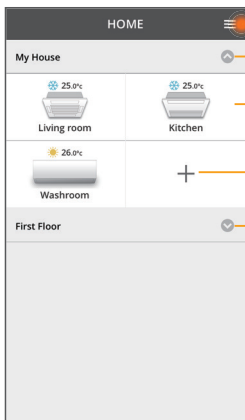

Main menu (Page 19)

1st group

Device

Add new device

2nd group

Main Menu

The screenshot shows a dark-themed menu with the following items and callouts:

- Owner** (expanded):
 - Options for administrator only (points to the Owner header)
 - User list (Page 19)
 - Change device password (Page 20)
 - Replace device (Page 20)
 - Change router settings (Page 20)
- Device list (List of devices (Page 21))
- Group list (List of groups (Page 22))
- Application settings (Change the language of the app)
- User's manual (User's manual)
- Terms of use (Terms of use)
- Privacy Notice (Privacy notice)
- Copyright (Copyright)
- Logout (Logout from current Panasonic ID)

User List

The screenshots show the following screens and callouts:

User list screen:

- Living room (dropdown)
- Table with columns: Note, Edit, Allow control, Delete
- Callouts:
 - Edit the name of the user (points to the Edit icon)
 - Enable control of user (points to the Allow control checkbox)
 - Edit / delete the user control (points to the Edit and Delete icons)
- UserA: Edit icon, Allow control checked, Delete icon
- UserB: Edit icon, Allow control checked, Delete icon
- UserC: Edit icon, Allow control unchecked, Delete icon
- UserD: Edit icon, Allow control unchecked, Delete icon
- UserE: Waiting for approval (orange button)

User approval screen:

- Air conditioner name (input field)
- Radio buttons for approval options:
 - Do not approve
 - Only allow monitoring air conditioner status
 - Allow both monitoring and controlling air conditioner (selected)
- Confirm button

Callout: User's control rights (points to the selected radio button)

Change of Device Password

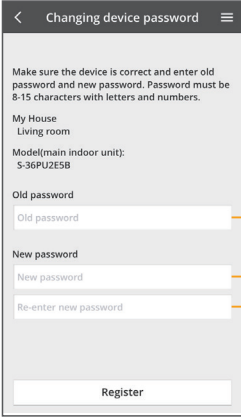

Input old password

Input new password

Retype new password

Replace the Device

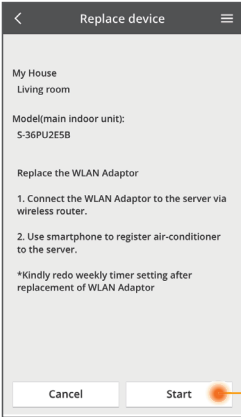

Select "Replace device" from the menu

Tap Start

Follow the step by step instruction from app

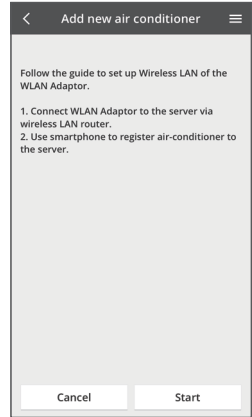

Change the Router Settings

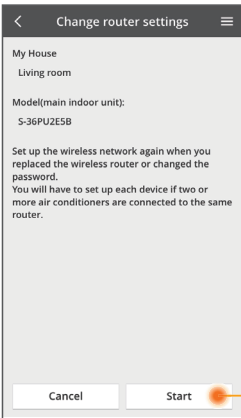

Select "Change router settings" from the menu

Tap Start

Follow the step by step instruction from app

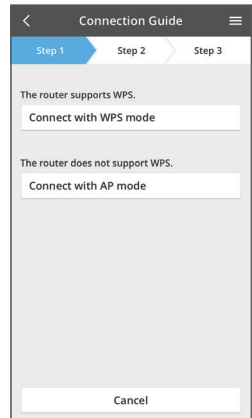

■ Device List

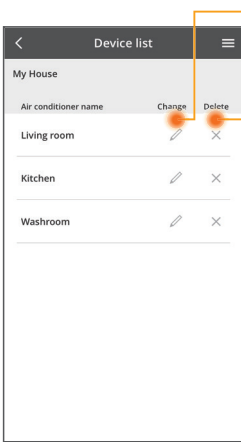

Edit the device information and setting

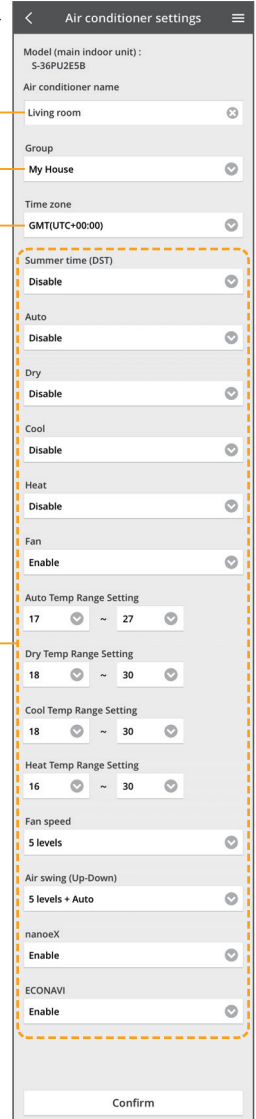

Edit device name

Change device group

Time zone selection

Features selection
(Features vary dependent on air conditioner model)

Delete the device

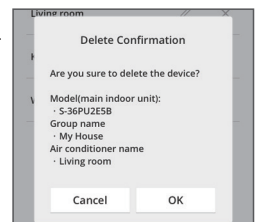

■ Group List

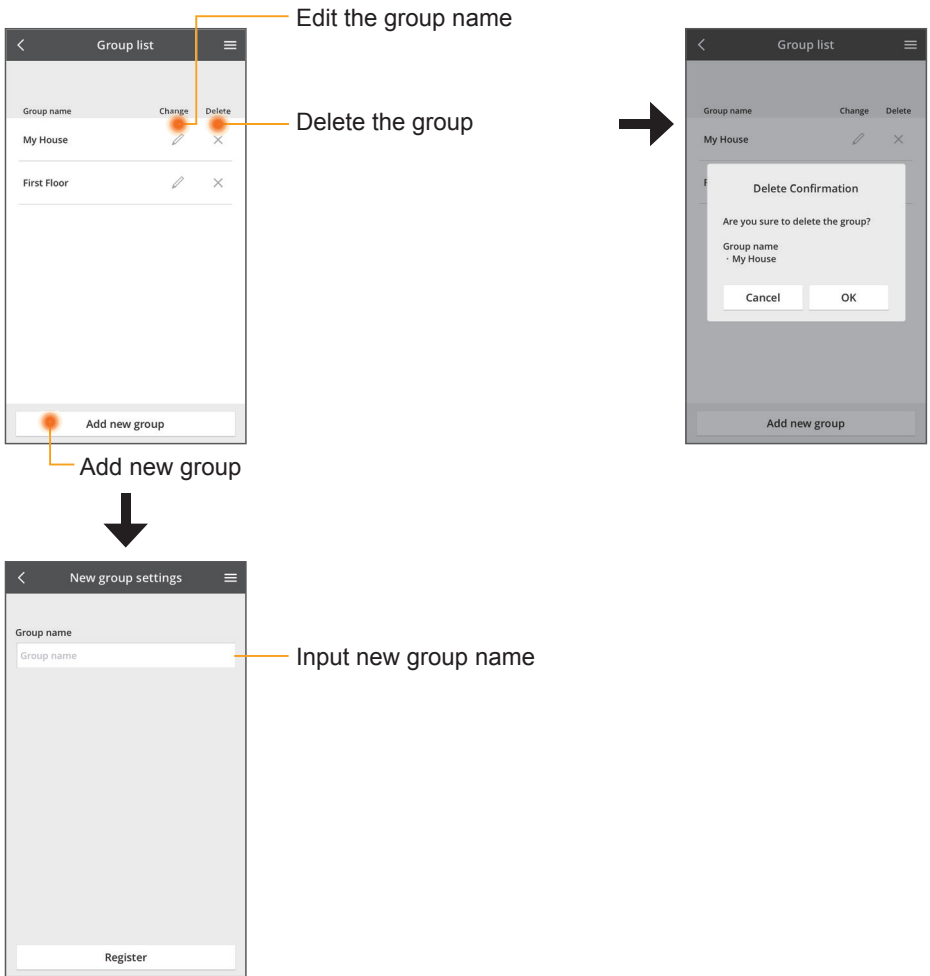

Main Device Screen

Back

Information

Indoor air temperature
* Subject to model compatibility

Outdoor ambient temperature

Switch between connected devices

Air conditioner Off / On

Statistics (Page 25)

My House

Living room

18 Jan 16:51

Cool

25.0°C SET

Change set temperature (dial)

Set temperature (Features vary dependent on air conditioner model)

Change set temperature (+ or -)

Weekly timer (Page 26)

Status for all air conditioners in the same group (Page 24)

Advanced settings (Page 24)

Operating mode (Page 24)

Information

Information

Users awaiting your approval

Please register me as a user

Please register me as a user

Error messages

My House
Living room
ED4 Indoor unit reception error

Notifications

User approval

Air conditioner error messages

Notifications

User's control right

My House
Living room

UserE

Approval note

Air conditioner name

Do not approve

Only allow monitoring air conditioner status

Allow both monitoring and controlling air conditioner

Confirm

■ Air Conditioner Status

Individual off / on toggle

Air conditioners status (Off / On, mode and set temperature)

All off / on

Confirmation
Turn on all air conditioners?
Cancel OK

■ Advanced settings

(Features vary dependent on air conditioner model)

Change fan speed

Auto fan toggle

Change swing position

Auto air swing toggle

Additional features off / on

■ Operating mode

(Features vary dependent on air conditioner model)

Mode selection
* Subject to model compatibility

Statistics



* Estimated energy consumption may not be supported by certain models.

Comparison



Information of the selected comparison dates

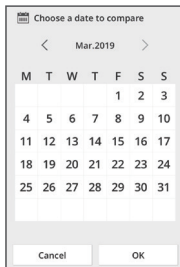

Date selection

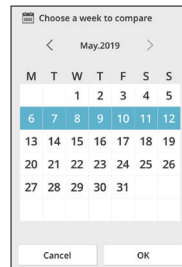

Week selection



Month selection



Year selection

Weekly Timer

Edit timer

Off / On timer toggle

Add new timer

Edit timer

No.	Time	Settings
1.	10:00	25.0°C
2.	14:00	OFF
3.	18:00	25.0°C
4.	20:00	OFF
5.	22:00	27.0°C
6.	-	-

Copy timer

Please select the day you would like to copy to.

- Mon
- Tue
- Wed
- Thu
- Fri
- Sat
- Sun

OK

Add New Timer

Set time

Set conditions

- Select mode**
- Select temperature**
- Off / On**

WLAN Adaptor Q & A

Initial setting

<p>“Panasonic Comfort Cloud” app cannot be installed in smartphone.</p>	<p>Check if OS of the smartphone is compatible. The APP is not guaranteed to work with all versions of Android OS.</p>
<p>WLAN Adaptor and router cannot be connected.</p>	<ul style="list-style-type: none"> ● Confirm that the POWER LED is on. ● Check the following if the LINK LED does not light. ● Ensure the router’s WLAN signal reaches the WLAN Adaptor, the SSID is not hidden, the MAC address setup is enabled for the WLAN Adaptor, the router’s dual band signal is enabled for 2.4 GHz connection. ● Check the network connections. (refer to Page 11) Refer to the smartphone and router installation manual for detail.
<p>Register additional air conditioner to “Panasonic Comfort Cloud” app.</p>	<p>Set the additional unit, following the first unit initial setup. It is recommended to name each of the registered air conditioner units to distinguish them easily.</p>
<p>Register additional user to control the air conditioner.</p>	<p>Download “Panasonic Comfort Cloud” app and create new Panasonic ID. Follow initial setting. Once the air conditioner is registered, input the preset device password (set by first user). Approval from administrator (first user) is required to complete the registration. For administrator approval, select the  Menu. Choose “Owner” and select “User List” to approve additional user.</p>

Wireless Connection

<p>Suspicious unauthorised access to the air conditioner (WLAN Adaptor).</p>	<p>Reset the WLAN Adaptor to manufacturing default condition by referring to “To transfer or dispose the WLAN Adaptor. When resetting the WLAN Adaptor because you have forgotten the password.” method in the next section. Complete initial connection setup.</p>
--	---

Others

<p>Change of smartphone's model.</p>	<p>Ensure the smartphone compatibility. Install "Panasonic Comfort Cloud" app and login using your Panasonic login ID and password. Complete by initial connection setup.</p>
<p>Change of WLAN Adaptor.</p>	<p>Change the WLAN Adaptor and then, use "Panasonic Comfort Cloud" app to select  Menu. Choose "Owner" and "Replace device". This shall be performed by authorised service dealer.</p>
<p>To transfer or dispose the WLAN Adaptor. When resetting the WLAN Adaptor because you have forgotten the password.</p>	<p>Reset the WLAN Adaptor to manufacturing default condition. <ol style="list-style-type: none"> 1. Press and hold the "SETUP" button on the WLAN Adaptor for 30 seconds. 2. After releasing the "SETUP" button on the WLAN Adaptor, press the "RESET" button on the WLAN Adaptor. 3. Once LINK LED has gone out, the factory reset is complete. <p>To unregister the air conditioner unit from "Panasonic Comfort Cloud" app, select the Menu and choose "Device list" to delete the set unit.</p> </p>
<p>Operations are not possible from the smartphone.</p>	<p>Check the following:</p> <ul style="list-style-type: none"> ● Ensure that the function is supported by the air conditioner. ● Ensure that remote controller operation is not disabled by the central control device.

Firmware Update Function

This product has functionality for connecting to the Panasonic firmware update server over the Internet to automatically update the device firmware to the latest version. To update the firmware, the device will do check, once per day, whether its firmware is the latest version after power up. And if an update is required, the update is applied and the device restarts automatically. Operations are not possible while the device is being restarted (Requires a maximum of five minutes).

Software License Information

This product incorporates the following software:

- (1) The software developed independently by or for Panasonic Corporation,
- (2) The software owned by third party and licensed to Panasonic Corporation,
- (3) The open source software under the BSD licence and/or equivalent licenses.

The software categorized as of (3) is distributed in the hope that it will be useful, but WITHOUT ANY WARRANTY, without even the implied warranty of MERCHANTABILITY or FITNESS FOR A PARTICULAR PURPOSE.

The following license terms shall be applied to Open-Sourced Components.

1. Supplicant license

Copyright (C) 2003-2016, Jouni Malinen <j@w1.fi > and contributors.
All rights reserved.

This software may be distributed, used, and modified under the terms of BSD license: Redistribution and use in source and binary forms, with or without modification, are permitted provided that the following conditions are met:

1. Redistributions of source code must retain the above copyright notice, this list of conditions and the following disclaimer.
2. Redistributions in binary form must reproduce the above copyright notice, this list of conditions and the following disclaimer in the documentation and/or other materials provided with the distribution.
3. Neither the name(s) of the above-listed copyright holder(s) nor the names of its contributors may be used to endorse or promote products derived from this software without specific prior written permission.

THIS SOFTWARE IS PROVIDED BY THE COPYRIGHT HOLDERS AND CONTRIBUTORS AS IS AND ANY EXPRESS OR IMPLIED WARRANTIES, INCLUDING, BUT NOT LIMITED TO, THE IMPLIED WARRANTIES OF MERCHANTABILITY AND FITNESS FOR A PARTICULAR PURPOSE ARE DISCLAIMED. IN NO EVENT SHALL THE COPYRIGHT OWNER OR CONTRIBUTORS BE LIABLE FOR ANY DIRECT, INDIRECT, INCIDENTAL, SPECIAL, EXEMPLARY, OR CONSEQUENTIAL DAMAGES (INCLUDING, BUT NOT LIMITED TO, PROCUREMENT OF SUBSTITUTE GOODS OR SERVICES; LOSS OF USE, DATA, OR PROFITS; OR BUSINESS INTERRUPTION) HOWEVER CAUSED AND ON ANY THEORY OF LIABILITY, WHETHER IN CONTRACT, STRICT LIABILITY, OR TORT (INCLUDING NEGLIGENCE OR OTHERWISE) ARISING IN ANY WAY OUT OF THE USE OF THIS SOFTWARE, EVEN IF ADVISED OF THE POSSIBILITY OF SUCH DAMAGE.

Copyright^①

- The App Store is a service mark of Apple Inc.
- iPhone is a trademark of Apple Inc. registered in the United States and other countries. The iPhone trademarks is used under license of iPhone Co., Ltd.
- Android and Google Play are trademarks or registered trademarks of Google Inc.
- "WPATM" and "WPA2TM" are trademarks of "Wi-Fi AllianceSM".
- Other names, company names, product names, etc described in this manual are trademarks or registered trademarks of each company. In the text, some TM and [®] marks are not listed.

About Software

This product incorporates the following software:

- 1) The software developed independently by or for Panasonic Corporation,
- 2) The software owned by third party and licensed to Panasonic Corporation,
- 3) The software licensed under the GNU GENERAL PUBLIC LICENSE Version 2.0 (GPL V2.0),
- 4) Open sourced software other than the software licensed under the GPL V2.0.

The software categorized as (3) and (4) are distributed in the hope that it will be useful, but without any warranty, without even the implied warranty of [merchantability] or [fitness for a particular purpose]. Please refer to the detailed terms and conditions thereof shown in the "Software License" menu on this product.

At least three (3) years from delivery of this product, Panasonic will give to any third party who contacts us at the contact information provided below, for a charge no more than our cost of physically performing source code distribution, a complete machine-readable copy of the corresponding source code covered under GPL V2.0 or the other licenses with the obligation to do so, as well as the respective copyright notice thereof.

Contact information:

oss-cd-request@gg.jp.panasonic.com

The source code and the copyright notice are also available for free in our website below.

<https://panasonic.net/cns/oss/ap/>

lwIP

lwIP is licensed under the BSD licence:

Copyright (c) 2001-2004 Swedish Institute of Computer Science. All rights reserved.

Redistribution and use in source and binary forms, with or without modification, are permitted provided that the following conditions are met:

1. Redistributions of source code must retain the above copyright notice, this list of conditions and the following disclaimer.
2. Redistributions in binary form must reproduce the above copyright notice, this list of conditions and the following disclaimer in the documentation and/or other materials provided with the distribution.
3. The name of the author may not be used to endorse or promote products derived from this software without specific prior written permission.

THIS SOFTWARE IS PROVIDED BY THE AUTHOR ``AS IS AND ANY EXPRESS OR IMPLIED WARRANTIES, INCLUDING, BUT NOT LIMITED TO, THE IMPLIED WARRANTIES OF MERCHANTABILITY AND FITNESS FOR A PARTICULAR PURPOSE ARE DISCLAIMED. IN NO EVENT SHALL THE AUTHOR BE LIABLE FOR ANY DIRECT, INDIRECT, INCIDENTAL, SPECIAL, EXEMPLARY, OR CONSEQUENTIAL DAMAGES (INCLUDING, BUT NOT LIMITED TO, PROCUREMENT OF SUBSTITUTE GOODS OR SERVICES; LOSS OF USE, DATA, OR PROFITS; OR BUSINESS INTERRUPTION) HOWEVER CAUSED AND ON ANY THEORY OF LIABILITY, WHETHER IN CONTRACT, STRICT LIABILITY, OR TORT (INCLUDING NEGLIGENCE OR OTHERWISE) ARISING IN ANY WAY OUT OF THE USE OF THIS SOFTWARE, EVEN IF ADVISED OF THE POSSIBILITY OF SUCH DAMAGE.

mbdTLS

Apache License

Version 2.0, January 2004

<http://www.apache.org/licenses/>

TERMS AND CONDITIONS FOR USE, REPRODUCTION, AND DISTRIBUTION

1. Definitions.

"License" shall mean the terms and conditions for use, reproduction, and distribution as defined by Sections 1 through 9 of this document. "Licensor" shall mean the copyright owner or entity authorized by the copyright owner that is granting the License.

"Legal Entity" shall mean the union of the acting entity and all other entities that control, are controlled by, or are under common control with that entity. For the purposes of this definition, "control" means (i) the power, direct or indirect, to cause the direction or management of such entity, whether by contract or otherwise, or (ii) ownership of fifty percent (50%) or more of the outstanding shares, or (iii) beneficial ownership of such entity.

"You" (or "Your") shall mean an individual or Legal Entity exercising permissions granted by this License.

"Source" form shall mean the preferred form for making modifications, including but not limited to software source code, documentation source, and configuration files.

"Object" form shall mean any form resulting from mechanical transformation or translation of a Source form, including but not limited to compiled object code, generated documentation, and conversions to other media types.

"Work" shall mean the work of authorship, whether in Source or Object form, made available under the License, as indicated by a copyright notice that is included in or attached to the work.

"Derivative Works" shall mean any work, whether in Source or Object form, that is based on (or derived from) the Work and for which the editorial revisions, annotations, elaborations, or other modifications represent, as a whole, an original work of authorship. For the purposes of this License, Derivative Works shall not include works that remain separable from, or merely link (or bind by name) to the interfaces of, the Work and Derivative Works thereof.

"Contribution" shall mean any work of authorship, including the original version of the Work and any modifications or additions to that Work or Derivative Works thereof, that is intentionally submitted to Licensor for inclusion in the Work by the copyright owner or by an individual or Legal Entity authorized to submit on behalf of the copyright owner.

For the purposes of this definition, "submitted" means any form of electronic, verbal, or written communication sent to the Licensor or its representatives, including but not limited to communication on electronic mailing lists, source code control systems, and issue tracking systems that are managed by, or on behalf of, the Licensor for the purpose of discussing and improving the Work, but excluding communication that is conspicuously marked or otherwise designated in writing by the copyright owner as "Not a Contribution." "Contributor" shall mean Licensor and any individual or Legal Entity on behalf of whom a Contribution has been received by Licensor and subsequently incorporated within the Work.

2. Grant of Copyright License. Subject to the terms and conditions of this License, each Contributor hereby grants to You a perpetual, worldwide, non-exclusive, no-charge, royalty-free, irrevocable copyright license to reproduce, prepare Derivative Works of, publicly display, publicly perform, sublicense, and distribute the Work and such Derivative Works in Source or Object form.

3. Grant of Patent License. Subject to the terms and conditions of this License, each Contributor hereby grants to You a perpetual, worldwide, non-exclusive, no-charge, royalty-free, irrevocable (except as stated in this section) patent license to make, have made, use, offer to sell, sell, import, and otherwise transfer the Work, where such license applies only to those patent claims licensable by such

Copyright②

Contributor that are necessarily infringed by their Contribution(s) alone or by combination of their Contribution(s) with the Work to which such Contribution(s) was submitted.

If You institute patent litigation against any entity (including a cross-claim or counterclaim in a lawsuit) alleging that the Work or a Contribution incorporated within the Work constitutes direct or contributory patent infringement, then any patent licenses granted to You under this License for that Work shall terminate as of the date such litigation is filed.

4. Redistribution. You may reproduce and distribute copies of the Work or Derivative Works thereof in any medium, with or without modifications, and in Source or Object form, provided that You meet the following conditions:

You must give any other recipients of the Work or Derivative Works a copy of this License; and

You must cause any modified files to carry prominent notices stating that You changed the files; and

You must retain, in the Source form of any Derivative Works that You distribute, all copyright, patent, trademark, and attribution notices from the Source form of the Work, excluding those notices that do not pertain to any part of the Derivative Works; and

If the Work includes a "NOTICE" text file as part of its distribution, then any Derivative Works that You distribute must include a readable copy of the attribution notices contained within such NOTICE file, excluding those notices that do not pertain to any part of the Derivative Works, in at least one of the following places: within a NOTICE text file distributed as part of the Derivative Works; within the Source form or documentation, if provided along with the Derivative Works; or, within a display generated by the Derivative Works, if and wherever such third-party notices normally appear. The contents of the NOTICE file are for informational purposes only and do not modify the License.

You may add Your own attribution notices within Derivative Works that You distribute, alongside or as an addendum to the NOTICE text from the Work, provided that such additional attribution notices cannot be construed as modifying the License.

You may add Your own copyright statement to Your modifications and may provide additional or different license terms and conditions for use, reproduction, or distribution of Your modifications, or for any such Derivative Works as a whole, provided Your use, reproduction, and distribution of the Work otherwise complies with the conditions stated in this License.

5. Submission of Contributions. Unless You explicitly state otherwise, any Contribution intentionally submitted for inclusion in the Work by You to the Licensor shall be under the terms and conditions of this License, without any additional terms or conditions.

Notwithstanding the above, nothing herein shall supersede or modify the terms of any separate license agreement you may have executed with Licensor regarding such Contributions.

6. Trademarks. This License does not grant permission to use the trade names, trademarks, service marks, or product names of the Licensor, except as required for reasonable and customary use in describing the origin of the Work and reproducing the content of the NOTICE file.

7. Disclaimer of Warranty. Unless required by applicable law or agreed to in writing, Licensor provides the Work (and each Contributor provides its Contributions) on an "AS IS" BASIS, WITHOUT WARRANTIES OR CONDITIONS OF ANY KIND, either express or implied, including, without limitation, any warranties or conditions of TITLE, NON-INFRINGEMENT, MERCHANTABILITY, or FITNESS FOR A PARTICULAR PURPOSE. You are solely responsible for determining the appropriateness of using or redistributing the Work and assume any risks associated with Your exercise of permissions under this License.

8. Limitation of Liability. In no event and under no legal theory, whether in tort (including negligence), contract, or otherwise, unless required by applicable law (such as deliberate and grossly negligent

acts) or agreed to in writing, shall any Contributor be liable to You for damages, including any direct, indirect, special, incidental, or consequential damages of any character arising as a result of this License or out of the use or inability to use the Work (including but not limited to damages for loss of goodwill, work stoppage, computer failure or malfunction, or any and all other commercial damages or losses), even if such Contributor has been advised of the possibility of such damages.

9. Accepting Warranty or Additional Liability. While redistributing the Work or Derivative Works thereof, You may choose to offer, and charge a fee for, acceptance of support, warranty, indemnity, or other liability obligations and/or rights consistent with this License. However, in accepting such obligations, You may act only on Your own behalf and/ or Your sole responsibility, not on behalf of any other Contributor, and only if You agree to indemnify, defend, and hold each Contributor harmless for any liability incurred by, or claims asserted against, such Contributor by reason of your accepting any such warranty or additional liability.

END OF TERMS AND CONDITIONS

WPA Supplicant

Copyright (c) 2003-2016, Jouni Malinen

<j@w1.fi> and contributors All Rights Reserved.

This program is licensed under the BSD license (the one with advertisement clause removed).

If you are submitting changes to the project, please see CONTRIBUTIONS file for more instructions.

License

This software may be distributed, used, and modified under the terms of BSD license:

Redistribution and use in source and binary forms, with or without modification, are permitted provided that the following conditions are met:

1. Redistributions of source code must retain the above copyright notice, this list of conditions and the following disclaimer.
2. Redistributions in binary form must reproduce the above copyright notice, this list of conditions and the following disclaimer in the documentation and/or other materials provided with the distribution.
3. Neither the name(s) of the above-listed copyright holder(s) nor the names of its contributors may be used to endorse or promote products derived from this software without specific prior written permission.

THIS SOFTWARE IS PROVIDED BY THE COPYRIGHT HOLDERS AND CONTRIBUTORS "AS IS" AND ANY EXPRESS OR IMPLIED WARRANTIES, INCLUDING, BUT NOT LIMITED TO, THE IMPLIED WARRANTIES OF MERCHANTABILITY AND FITNESS FOR A PARTICULAR PURPOSE ARE DISCLAIMED. IN NO EVENT SHALL THE COPYRIGHT OWNER OR CONTRIBUTORS BE LIABLE FOR ANY DIRECT, INDIRECT, INCIDENTAL, SPECIAL, EXEMPLARY, OR CONSEQUENTIAL DAMAGES (INCLUDING, BUT NOT LIMITED TO, PROCUREMENT OF SUBSTITUTE GOODS OR SERVICES; LOSS OF USE, DATA, OR PROFITS; OR BUSINESS INTERRUPTION) HOWEVER CAUSED AND ON ANY THEORY OF LIABILITY, WHETHER IN CONTRACT, STRICT LIABILITY, OR TORT (INCLUDING NEGLIGENCE OR OTHERWISE) ARISING IN ANY WAY OUT OF THE USE OF THIS SOFTWARE, EVEN IF ADVISED OF THE POSSIBILITY OF SUCH DAMAGE.

Free RTOS

The FreeRTOS source code is licensed by a "modified" GNU General Public License (GPL). The modification is provided in the form of an exception.

NOTE: The modification to the GPL is included to allow you to distribute a combined work that includes FreeRTOS without being obliged to provide the source code for proprietary components outside of the FreeRTOS kernel.

Copyright②

The FreeRTOS GPL Exception Text:

Any FreeRTOS source code, whether modified or in its original release form, or whether in whole or in part, can only be distributed by you under the terms of the GNU General Public License plus this exception. An independent module is a module which is not derived from or based on FreeRTOS.

Clause 1:

Linking FreeRTOS statically or dynamically with other modules is making a combined work based on FreeRTOS. Thus, the terms and conditions of the GNU General Public License cover the whole combination.

As a special exception, the copyright holder of FreeRTOS gives you permission to link FreeRTOS with independent modules that communicate with FreeRTOS solely through the FreeRTOS API interface, regardless of the license terms of these independent modules, and to copy and distribute the resulting combined work under terms of your choice, provided that

- + Every copy of the combined work is accompanied by a written statement that details to the recipient the version of FreeRTOS used and an offer by yourself to provide the FreeRTOS source code (including any modifications you may have made) should the recipient request it.
- + The combined work is not itself an RTOS, scheduler, kernel or related product.
- + The independent modules add significant and primary functionality to FreeRTOS and do not merely extend the existing functionality already present in FreeRTOS.

Clause 2:

FreeRTOS may not be used for any competitive or comparative purpose, including the publication of any form of run time or compile time metric, without the express permission of Real Time Engineers Ltd. (this is the norm within the industry and is intended to ensure information accuracy).

The standard GPL exception text:

GNU GENERAL PUBLIC LICENSE

Version 2, June 1991

Copyright (C) 1989, 1991 Free Software Foundation, Inc. 59 Temple Place, Suite 330, Boston, MA 02111-1307 USA
Everyone is permitted to copy and distribute verbatim copies of this license document, but changing it is not allowed.

Preamble

The licenses for most software are designed to take away your freedom to share and change it. By contrast, the GNU General Public License is intended to guarantee your freedom to share and change free software—to make sure the software is free for all its users. This General Public License applies to most of the Free Software Foundation's software and to any other program whose authors commit to using it. (Some other Free Software Foundation software is covered by the GNU Library General Public License instead.) You can apply it to your programs, too.

When we speak of free software, we are referring to freedom, not price. Our General Public Licenses are designed to make sure that you have the freedom to distribute copies of free software (and charge for this service if you wish), that you receive source code or can get it if you want it, that you can change the software or use pieces of it in new free programs; and that you know you can do these things.

To protect your rights, we need to make restrictions that forbid anyone to deny you these rights or to ask you to surrender the rights. These restrictions translate to certain responsibilities for you if you distribute copies of the software, or if you modify it.

For example, if you distribute copies of such a program, whether gratis or for a fee, you must give the recipients all the rights that you have. You must make sure that they, too, receive or can get the source code. And you must show them these terms so they know their rights.

We protect your rights with two steps: (1) copyright the software, and (2) offer you this license which gives you legal permission to copy, distribute and/or modify the software.

Also, for each author's protection and ours, we want to make certain that everyone understands that there is no warranty for this free software. If the software is modified by someone else and passed on, we want its recipients to know that what they have is not the original, so that any problems introduced by others will not reflect on the original authors' reputations.

Finally, any free program is threatened constantly by software patents. We wish to avoid the danger that redistributors of a free program will individually obtain patent licenses, in effect making the program proprietary. To prevent this, we have made it clear that any patent must be licensed for everyone's free use or not licensed at all.

The precise terms and conditions for copying, distribution and modification follow.

GNU GENERAL PUBLIC LICENSE TERMS AND CONDITIONS FOR COPYING, DISTRIBUTION AND MODIFICATION

0. This License applies to any program or other work which contains a notice placed by the copyright holder saying it may be distributed under the terms of this General Public License. The "Program", below, refers to any such program or work, and a "work based on the Program" means either the Program or any derivative work under copyright law: that is to say, a work containing the Program or a portion of it, either verbatim or with modifications and/or translated into another language. (Hereinafter, translation is included without limitation in the term "modification".) Each licensee is addressed as "you".

Activities other than copying, distribution and modification are not covered by this License; they are outside its scope. The act of running the Program is not restricted, and the output from the Program is covered only if its contents constitute a work based on the Program (independent of having been made by running the Program). Whether that is true depends on what the Program does.

1. You may copy and distribute verbatim copies of the Program's source code as you receive it, in any medium, provided that you conspicuously and appropriately publish on each copy an appropriate copyright notice and disclaimer of warranty; keep intact all the notices that refer to this License and to the absence of any warranty; and give any other recipients of the Program a copy of this License along with the Program.

You may charge a fee for the physical act of transferring a copy, and you may at your option offer warranty protection in exchange for a fee.

2. You may modify your copy or copies of the Program or any portion of it, thus forming a work based on the Program, and copy and distribute such modifications or work under the terms of Section 1 above, provided that you also meet all of these conditions:

- a) You must cause the modified files to carry prominent notices stating that you changed the files and the date of any change.
- b) You must cause any work that you distribute or publish, that in whole or in part contains or is derived from the Program or any part thereof, to be licensed as a whole at no charge to all third parties under the terms of this License.
- c) If the modified program normally reads commands interactively when run, you must cause it, when started running for such interactive use in the most ordinary way, to print or display an announcement including an appropriate copyright notice and a notice that there is no warranty (or else, saying that you provide a warranty) and that users may redistribute the program under these conditions, and telling the user how to view a copy of this License. (Exception: if the Program itself is interactive but does not normally print such an announcement, your work based on the Program is not required to print an announcement.)

Copyright³

These requirements apply to the modified work as a whole. If identifiable sections of that work are not derived from the Program, and can be reasonably considered independent and separate works in themselves, then this License, and its terms, do not apply to those sections when you distribute them as separate works. But when you distribute the same sections as part of a whole which is a work based on the Program the distribution of the whole must be on the terms of this License, whose permissions for other licensees extend to the entire whole, and thus to each and every part regardless of who wrote it.

Thus, it is not the intent of this section to claim rights or contest your rights to work written entirely by you; rather, the intent is to exercise the right to control the distribution of derivative or collective works based on the Program.

In addition, mere aggregation of another work not based on the Program with the Program (or with a work based on the Program) on a volume of a storage or distribution medium does not bring the other work under the scope of this License.

3. You may copy and distribute the Program (or a work based on it, under Section 2) in object code or executable form under the terms of Sections 1 and 2 above provided that you also do one of the following:

- a) Accompany it with the complete corresponding machine-readable source code, which must be distributed under the terms of Sections 1 and 2 above on a medium customarily used for software interchange; or,
- b) Accompany it with a written offer, valid for at least three years, to give any third party, for a charge no more than your cost of physically performing source distribution, a complete machine-readable copy of the corresponding source code, to be distributed under the terms of Sections 1 and 2 above on a medium customarily used for software interchange; or,
- c) Accompany it with the information you received as to the offer to distribute corresponding source code. (This alternative is allowed only for noncommercial distribution and only if you received the program in object code or executable form with such an offer, in accord with Subsection b above.)

The source code for a work means the preferred form of the work for making modifications to it. For an executable work, complete source code means all the source code for all modules it contains, plus any associated interface definition files, plus the scripts used to control compilation and installation of the executable. However, as a special exception, the source code distributed need not include anything that is normally distributed (in either source or binary form) with the major components (compiler, kernel, and so on) of the operating system on which the executable runs, unless that component itself accompanies the executable.

If distribution of executable or object code is made by offering access to copy from a designated place, then offering equivalent access to copy the source code from the same place counts as distribution of the source code, even though third parties are not compelled to copy the source along with the object code.

4. You may not copy, modify, sublicense, or distribute the Program except as expressly provided under this License. Any attempt otherwise to copy, modify, sublicense or distribute the Program is void, and will automatically terminate your rights under this License. However, parties who have received copies, or rights, from you under this License will not have their licenses terminated so long as such parties remain in full compliance.

5. You are not required to accept this License, since you have not signed it. However, nothing else grants you permission to modify or distribute the Program or its derivative works. These actions are prohibited by law if you do not accept this License. Therefore, by modifying or distributing the Program (or any work based on the Program), you indicate your acceptance of this License to do so, and all its terms and conditions for copying, distributing or modifying the Program or works based on it.

6. Each time you redistribute the Program (or any work based on the Program), the recipient automatically receives a license from the original licensor to copy, distribute or modify the Program subject to these terms and conditions. You may not impose any further restrictions on the recipients' exercise of the rights granted herein. You are not responsible for enforcing compliance by third parties to this License.

7. If, as a consequence of a court judgment or allegation of patent infringement or for any other reason (not limited to patent issues), conditions are imposed on you (whether by court order, agreement or otherwise) that contradict the conditions of this License, they do not excuse you from the conditions of this License. If you cannot distribute so as to satisfy simultaneously your obligations under this License and any other pertinent obligations, then as a consequence you may not distribute the Program at all. For example, if a patent license would not permit royalty-free redistribution of the Program by all those who receive copies directly or indirectly through you, then the only way you could satisfy both it and this License would be to refrain entirely from distribution of the Program.

If any portion of this section is held invalid or unenforceable under any particular circumstance, the balance of the section is intended to apply and the section as a whole is intended to apply in other circumstances. It is not the purpose of this section to induce you to infringe any patents or other property right claims or to contest validity of any such claims; this section has the sole purpose of protecting the integrity of the free software distribution system, which is implemented by public license practices. Many people have made generous contributions to the wide range of software distributed through that system in reliance on consistent application of that system; it is up to the author/donor to decide if he or she is willing to distribute software through any other system and a licensee cannot impose that choice.

This section is intended to make thoroughly clear what is believed to be a consequence of the rest of this License.

8. If the distribution and/or use of the Program is restricted in certain countries either by patents or by copyrighted interfaces, the original copyright holder who places the Program under this License may add an explicit geographical distribution limitation excluding those countries, so that distribution is permitted only in or among countries not thus excluded. In such case, this License incorporates the limitation as if written in the body of this License.

9. The Free Software Foundation may publish revised and/or new versions of the General Public License from time to time. Such new versions will be similar in spirit to the present version, but may differ in detail to address new problems or concerns. Each version is given a distinguishing version number. If the Program specifies version number of this License which applies to it and "any later version", you have the option of following the terms and conditions either of that version or of any later version published by the Free Software Foundation. If the Program does not specify a version number of this License, you may choose any version ever published by the Free Software Foundation.

10. If you wish to incorporate parts of the Program into other free programs whose distribution conditions are different, write to the author to ask for permission. For software which is copyrighted by the Free Software Foundation, write to the Free Software Foundation; we sometimes make exceptions for this. Our decision will be guided by the two goals of preserving the free status of all derivatives of our free software and of promoting the sharing and reuse of software generally.

Copyright③

NO WARRANTY

11. BECAUSE THE PROGRAM IS LICENSED FREE OF CHARGE, THERE IS NO WARRANTY FOR THE PROGRAM, TO THE EXTENT PERMITTED BY APPLICABLE LAW. EXCEPT WHEN OTHERWISE STATED IN WRITING THE COPYRIGHT HOLDERS AND/OR OTHER PARTIES PROVIDE THE PROGRAM "AS IS" WITHOUT WARRANTY OF ANY KIND, EITHER EXPRESSED OR IMPLIED, INCLUDING, BUT NOT LIMITED TO, THE IMPLIED WARRANTIES OF MERCHANTABILITY AND FITNESS FOR A PARTICULAR PURPOSE. THE ENTIRE RISK AS TO THE QUALITY AND PERFORMANCE OF THE PROGRAM IS WITH YOU. SHOULD THE PROGRAM PROVE DEFECTIVE, YOU ASSUME THE COST OF ALL NECESSARY SERVICING, REPAIR OR CORRECTION.

12. IN NO EVENT UNLESS REQUIRED BY APPLICABLE LAW OR AGREED TO IN WRITING WILL ANY COPYRIGHT HOLDER, OR ANY OTHER PARTY WHO MAY MODIFY AND/OR REDISTRIBUTE THE PROGRAM AS PERMITTED ABOVE, BE LIABLE TO YOU FOR DAMAGES, INCLUDING ANY GENERAL, SPECIAL, INCIDENTAL OR CONSEQUENTIAL DAMAGES ARISING OUT OF THE USE OR INABILITY TO USE THE PROGRAM (INCLUDING BUT NOT LIMITED TO LOSS OF DATA OR DATA BEING RENDERED INACCURATE OR LOSSES SUSTAINED BY YOU OR THIRD PARTIES OR A FAILURE OF THE PROGRAM TO OPERATE WITH ANY OTHER PROGRAMS), EVEN IF SUCH HOLDER OR OTHER PARTY HAS BEEN ADVISED OF THE POSSIBILITY OF SUCH DAMAGES.

END OF TERMS AND CONDITIONS

How to Apply These Terms to Your New Programs

If you develop a new program, and you want it to be of the greatest possible use to the public, the best way to achieve this is to make it free software which everyone can redistribute and change under these terms.

To do so, attach the following notices to the program. It is safest to attach them to the start of each source file to most effectively convey the exclusion of warranty; and each file should have at least the "copyright" line and a pointer to where the full notice is found.

<one line to give the program's name and a brief idea of what it does.>

Copyright (C) <year> <name of author>

This program is free software; you can redistribute it and/or modify it under the terms of the GNU General Public License** as published by the Free Software Foundation; either version 2 of the License, or (at your option) any later version.

This program is distributed in the hope that it will be useful, but WITHOUT ANY WARRANTY; without even the implied warranty of MERCHANTABILITY or FITNESS FOR A PARTICULAR PURPOSE. See the GNU General Public License for more details.

You should have received a copy of the GNU General Public License along with this program; if not, write to the Free Software Foundation, Inc., 59 Temple Place, Suite 330, Boston, MA 02111-1307 USA

Also add information on how to contact you by electronic and paper mail.

If the program is interactive, make it output a short notice like this when it starts in an interactive mode:

Gnomovision version 69, Copyright (C) year name of author
Gnomovision comes with ABSOLUTELY NO WARRANTY; for details type `show w`.

This is free software, and you are welcome to redistribute it under certain conditions; type `show c` for details.

The hypothetical commands `show w` and `show c` should show the appropriate parts of the General Public License. Of course, the commands you use may be called something other than `show w` and `show c`; they could even be mouseclicks or menu items--whatever suits your program.

You should also get your employer (if you work as a programmer) or your school, if any, to sign a "copyright disclaimer" for the program, if necessary. Here is a sample; alter the names:

Yoyodyne, Inc., hereby disclaims all copyright interest in the program "Gnomovision" (which makes passes at compilers) written by James Hacker.

<signature of Ty Coon>, 1 April 1989

Ty Coon, President of Vice

This General Public License does not permit incorporating your program into proprietary programs. If your program is a subroutine library, you may consider it more useful to permit linking proprietary applications with the library. If this is what you want to do, use the GNU Library General Public License instead of this License.

Information for Users on Collection and Disposal of Old Equipment



- Your product is marked with this symbol. This symbol means that electrical and electronic products shall not be mixed with unsorted household waste.
- Do not try to dismantle the system yourself: the dismantling of the product and of other parts must be done by a qualified installer in accordance with relevant local and national legislation.
- Product and waste must be treated at a specialized treatment facility for re-use, recycling and recovery.

These symbols on the products, packaging, and/or accompanying documents mean that used electrical and electronic products and batteries should not be mixed with general household waste.

For proper treatment, recovery and recycling of old products and used batteries, please take them to applicable collection points, in accordance with your national legislation and the Directives 2002/96/EC and 2006/66/EC.

By disposing of these products and batteries correctly, you will help to save valuable resources and prevent any potential negative effects on human health and the environment which could otherwise arise from inappropriate waste handling.

For more information about collection and recycling of old products and batteries, please contact your local municipality, your waste disposal service or the point of sale where you purchased the items.

Penalties may be applicable for incorrect disposal of this waste, in accordance with national legislation.

For users in the European Union

If you wish to discard electrical and electronic equipment, please contact your dealer or supplier for further information.

[Information on Disposal in other Countries outside the European Union]

These symbols are only valid in the European Union. If you wish to discard these items, please contact your local authorities or dealer and ask for the correct method of disposal.



Declaration of Conformity (DOC)

Hereby, "Panasonic Corporation" declares that this product is in compliance with the essential requirements and other relevant provisions of Directive 2014/53/EU

The full text of the EU declaration of conformity is available at the following internet address: <http://www.ptc.panasonic.eu/>

Authorized Representative: Panasonic Testing Centre, Panasonic Marketing Europe GmbH, Winsbergring 15, 22525 Hamburg, Germany

Norway: There are usage restrictions within a radius of 20 km from the centre of Ny-Alesund on Svalbard.

Specifications

Input Voltage	DC12 V (supplied from the T10 connector of the indoor unit)
Power consumption	Max: 2.4 W
Size	(H) 120 mm × (W) 70 mm × (D) 25 mm
Weight	190 g (including communication lines)
Interface	Wireless LAN
Wireless LAN standard	IEEE 802.11 b/g/n
Frequency range	2.4 GHz band
Encryption	WPA2-PSK (TKIP/AES)
Temperature/ Humidity range	0 °C to 55 °C / 20 % to 80 % (no condensation) *Indoor use only

Setting Information

WLAN Adaptor serial number (ID)	
Indoor unit model name	
Indoor unit serial number	
Outdoor unit model name	
Outdoor unit serial number	
System commissioning date	
WLAN Adaptor installation date	

Installer Contact Details

Name	
Telephone number	

Maximum radio-frequency power transmitted in the frequency bands

Type of wireless	Frequency band	Max EIRP (dBm)
WLAN	2412-2472 MHz	20 dBm

Regulatory Information

R-NZ 

Authorized representative in EU
Panasonic Testing Centre
Panasonic Marketing Europe GmbH
Winsbergring 15, 22525 Hamburg, Germany