

Panasonic

Operating Instructions (Household use) Oral Irrigator Model No. EW-DJ26



- ▶ **In case of an abnormality or malfunction**
 - Immediately stop using and unplug the power plug when using the charger.
 - Failure to do so may cause fire, electric shock or injury.
 - <Abnormality or malfunction cases>
 - The main unit or charger is deformed or abnormally hot.
 - The main unit or charger smells of burning.
 - There is abnormal sound during use or charging of the main unit or charger.
 - Immediately request inspection or repair to an authorized service center.
- ▶ **This product**
 - This product has a built-in rechargeable battery. Do not throw into fire, apply heat, or charge, use, or leave in a high temperature environment.
 - Doing so may cause overheating, ignition, or explosion of the built-in rechargeable battery.
 - Do not modify or repair.
 - Doing so may cause fire, electric shock, or injury.
 - Contact an authorized service center for repair (battery change, etc.).
 - Never disassemble except when disposing of the product.
 - Doing so may cause fire, electric shock, or injury.
- ▶ **Cleaning**
 - Always unplug the power plug from a household outlet when cleaning the charger.
 - Failure to do so may cause electric shock or injury.
 - Regularly clean the power plug to prevent dust from accumulating (once every half a year).
 - Failure to do so may cause fire due to insulation failure caused by humidity.
 - Disconnect the power plug and wipe with a dry cloth.
- ▶ **Note the following precautions**
 - This appliance is not intended for use by persons (including children) with reduced physical, sensory or mental capabilities, or lack of experience and knowledge, unless they have been given supervision or instruction concerning use of the appliance by a person responsible for their safety.
 - Children should be supervised to ensure that they do not play with the appliance.
 - Failure to do so may cause an accident or injury.
 - The supply cord cannot be replaced. If the cord is damaged, the charger should be scrapped.
 - Failure to do so may cause an accident or injury.

⚠ CAUTION

- ▶ **Preventing damage to teeth and gums**
 - People who are unable to operate should not use this appliance.
 - People with weak oral senses should not use this appliance.
 - Doing so may cause injury or damage to teeth and gums.
 - People who may have periodontal disease, have teeth being treated, or concerned about symptoms within their mouth should consult a dentist before use.
 - Failure to do so may cause injury or damage to teeth and gums.
- ▶ **This product**
 - Never use for a purpose other than oral cleaning.
 - Doing so may cause an accident or injury when the stream of water is pointed toward the eyes, nose, ears, or throat.
 - Do not fill the water tank with water warmer than 40 °C.
 - Doing so may cause burns.
 - Do not share nozzle with your family or other people.
 - Doing so may cause infection or inflammation.
 - Do not place a metallic object such as a coin or a clip on top of the charger.
 - Doing so may cause burns due to excessive heat.
- ▶ **Note the following precautions**
 - Do not allow metal objects or trash to adhere to the power plug.
 - Doing so may cause electric shock or fire due to a short circuit.
 - Do not drop or subject to shock.
 - Doing so may cause injury.
 - Do not wrap the power cord around the charger when storing.
 - Doing so may cause the wire in the power cord to break with the load, and may cause fire due to a short circuit.
 - Disconnect the power plug from the household outlet when not charging.
 - Failure to do so may cause electric shock or fire due to electrical leakage resulting from insulation deterioration.
 - Disconnect the power plug by holding onto it instead of the power cord.
 - Failure to do so may cause electric shock or fire due to a short circuit.
 - After use, clean the main unit and the nozzle and dry them.
 - Failure to do so may cause damage to your health due to propagation of mold and bacteria.

Handling of the removed battery when disposing

⚠ DANGER

- The rechargeable battery is exclusively for use with this appliance. Do not use the battery with other products.
- Do not charge the battery after it has been removed from the product.
- Do not throw into fire or apply heat.
- Do not hit, disassemble, modify, or puncture with a nail.
- Do not let the positive and negative terminals of the battery get in contact with each other through metallic objects.
- Do not carry or store the battery together with metallic jewellery such as necklaces and hairpins.
- Do not use or leave the battery where it will be exposed to high temperatures, such as under direct sunlight or near other sources of heat.
- Never peel off the tube.
 - Doing so may cause overheating, ignition, or explosion.

⚠ WARNING

- After removing the rechargeable battery, do not keep it within reach of children and infants.
 - The battery will harm the body if accidentally swallowed.
 - If this happens, consult a physician immediately.

- If the battery fluid leaks out and comes in contact with the eyes, do not rub the eyes, and thoroughly rinse with clean water, such as tap water.
 - Failure to do so may cause eye injury.
- Consult a physician immediately.

⚠ CAUTION

- If the battery fluid leaks out and comes in contact with the skin or clothes, rinse off with clean water, such as tap water.
 - Failure to do so may cause inflammation.

Important information

- When you first begin using the oral irrigator, you may experience slight bleeding of the gums even though your gums may be healthy. This is because your gums are receiving stimulation by the oral irrigator for the first time. The bleeding should stop after one or two weeks of use. Bleeding that persists for more than two weeks may be indication of an abnormal condition of your gums, such as periodontal disease. In this case, stop using the oral irrigator and consult your dentist.
- Do not put salt, mouthwash or other chemicals into the water tank. Doing so may cause malfunction.
- Do not dry the appliance with a dryer or a fan heater. Doing so may cause malfunction or deformation of the parts.
- Store the appliance in a place with low humidity after use. Leaving the appliance in a bathroom may cause malfunction.
- The following symbol indicates that a specific detachable power supply unit is required for connecting the electrical appliance to the supply mains. The type reference of power supply unit is marked near the symbol.



- Charge the appliance correctly according to these Operating Instructions. (See "Charging".)
- This appliance contains a battery that is only replaceable by skilled persons. Please contact an authorized service center for the details of repair.

Parts identification

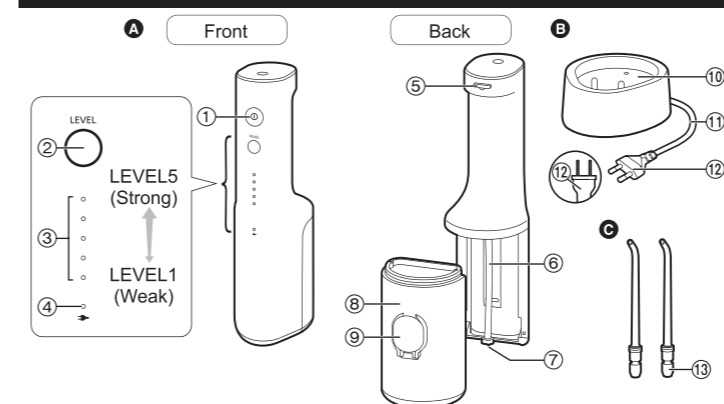

A Main unit

- ① Power switch (⏻)
- ② Level switch
- ③ Water pressure level indicator (blue)
- ④ Low battery/charge status indicator (red)
- ⑤ Nozzle release button
- ⑥ Suction hose
- ⑦ Filter
- ⑧ Water tank
- ⑨ Water tank cap

B Charger (RE8-59)

- (The shape of the power plug differs depending on the area.)
- ⑩ Charging section
- ⑪ Power cord
- ⑫ Power plug
- ⑬ Regular nozzle (x2)
 - The nozzle is a consumable.

Note

There may be moisture inside the main unit (water tank and suction hose) left from the distilled water used for product testing.

Charging

When the battery capacity is low

- The low battery/charge status indicator (🔴) flashes once a second in the following cases.
- When you turn on the power switch
 - When you press the level switch
 - When you turn off the power switch (the flashing stops after 5 seconds)
- When the low battery/charge status indicator (🔴) is flashing, charge the battery.

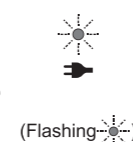

- 1 Insert the power plug into a household outlet.
- 2 Insert the main unit straight into the charging section with the front side facing forward.

- Charging is completed after approx. 17 hours. (The charging time may vary with the remaining battery capacity.)

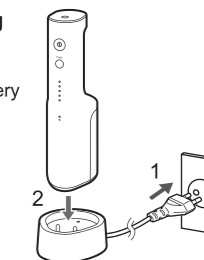

▶ Display while charging

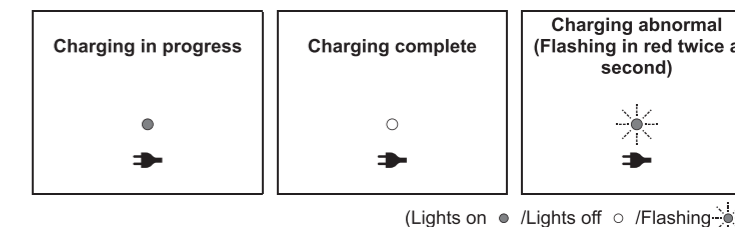

(Lights on ● / Lights off ○ / Flashing 🌟)

- 3 For safety and energy saving, disconnect the power plug.

- Charging the battery for more than 17 hours will not cause any damage to the main unit.

How to check if charging is completed

After charging is completed, if you connect and then disconnect the main unit to and from the charger, the low battery/charge status indicator (🔴) lights on and then lights off after 5 seconds.

Operating time after a full charge

Approx. 10 minutes
(When the water pressure level is set to 5)
• It varies with the ambient temperature and usage condition.

▶ Notes

- The charging time may differ when the appliance is used for the first time, or if it has not been used for more than 6 months. In addition, the low battery/charge status indicator (🔴) may not light on in the first several minutes of charging, but it will light on as the charging proceeds.
- The battery will deteriorate if not used for over 6 months, so make sure to perform a full charge at least once every 6 months.
- Recommended ambient temperature for charging is 5 °C – 35 °C. The battery may not charge properly or not at all under extreme low or high temperatures.
- To keep charging the battery will not affect battery performance.

How to use

- 1 Fill the water tank with water.

1. Open the water tank cap.

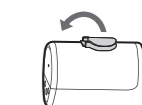

2. Add water while keeping the main unit level.

- Always use new tap water or lukewarm water.
- If you feel the water is cold, use lukewarm water with a temperature of 40 °C or less.



Full-water position



3. Close the water tank cap securely.



- 2 Install the nozzle.

- Press in firmly until a "click" is heard.



Thank you for purchasing this Panasonic product.

Before operating this unit, please read these instructions completely and save them for future use.

Safety precautions

Make sure to follow these instructions.

To prevent accidents, injuries or damage to property, please follow the instructions below.

■ The following chart indicates the degree of damage caused by improper operation.

| | |
|------------------|--|
| ⚠ DANGER | Indicates a potential hazard that will result in serious injury or death. |
| ⚠ WARNING | Indicates a potential hazard that could result in serious injury or death. |
| ⚠ CAUTION | Indicates a potential hazard that could result in minor injury or property damage. |

⚠ WARNING

- ▶ **Preventing accidents**
 - Do not store within the reach of children or infants. Do not let them use it.
 - Doing so may cause an accident or injury due to accidental ingestion of removable parts.
- ▶ **Power supply**
 - Do not connect or disconnect the power plug to a household outlet with a wet hand.
 - Doing so may cause electric shock or injury.
 - Do not immerse the charger in water or wash it with water.
 - Do not place the charger over or near water filled sink or bathtub.
 - Do not use when the power cord or the power plug is damaged or when the fitting into the household outlet is loose.
 - Do not damage, modify, forcefully bend, pull, twist, or bundle the power cord or the power plug. Also, do not place anything heavy on or pinch the power cord.
 - Doing so may cause electric shock or fire due to a short circuit.
 - Do not use anything other than the supplied charger for any purpose. Also, do not use any other product with the supplied charger. (See "Parts identification".)
 - Doing so may cause burns or fire due to a short circuit.
 - Do not use in a way exceeding the rating of the household outlet or the wiring.
 - Exceeding the rating by connecting too many power plugs to one household outlet may cause fire due to overheating.
 - Always ensure the appliance is operated on an electric power source matched to the rated voltage indicated on the charger.
 - Fully insert the power plug.
 - Failure to do so may cause fire or electric shock.

3 Press the level switch, and select the water pressure level.

- When you press the level switch, the water pressure level that was used last time is selected. Then each time you press the level switch, the water pressure level is switched as follows: 1 (weak) → 2 → 3 → 4 → 5 (strong) → 1...

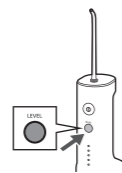

4 Clean inside your mouth with the water jet.

- Place the nozzle in your mouth.
 - Close your mouth gently.
 - Turn on the power switch (ⓘ).
- You can switch the water pressure level by pressing the level switch, even while using the appliance.
 - If the main unit is tilted too much, the water will not come out from the nozzle.
 - It can also be used in a bath.



- Point 1**
Keep your face over the basin.
- Point 2**
Place the main unit upright.

5 To prevent the water from splashing about, turn off the power switch (ⓘ) while keeping the nozzle in your mouth after use.

If the water tank cap comes off
You can attach the water tank cap by following the procedure below when it comes off.

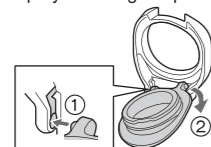

About the water pressure level memory function

The last selected water pressure level will be remembered, from which the appliance will start next time.
When the appliance has not been used for a long time or when the battery is used up, the water pressure level will return to 1.

Operation time with full water
Approx. 50 seconds.
(When the water pressure level is set to 5)

- **Notes**
- When using the appliance for the first time, please press the power switch (ⓘ) and check the water pressure level while water is coming out. When you feel that the irritation is strong, turn off the power switch and use the appliance from water pressure level 1.
 - The appliance may not operate in an ambient temperature approximately 5 °C or lower.
 - Do not push the tip of the nozzle too hard against the teeth or gums.
 - Do not turn on the power switch (ⓘ) when the water tank is empty unless you are drying the moisture inside the main unit. (Doing so may cause malfunction.)

Points of care

- Adjust the angle and movement of the nozzle according to the purpose and the area you want to clean.
- For areas where the gums are sensitive, please set the water pressure level to 1.

Regular nozzle
To clean with gentle water jet.

- **How to use**
- Interdental cleaning**
- Direct the water jet onto the space between the teeth.
 - Direct from the front and rear sides of the teeth.



- Periodontal pocket cleaning**
- Aim the water jet at the space between teeth and gums.
 - Slowly shift the water jet along the gums.
 - Clean the front and back of the teeth and behind the molars as well.



- Gums care**
- Stimulate the gums.

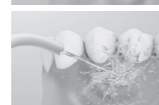

After use

Please clean the appliance after each use.

1 To keep clean, pour out the remaining water.

- Open the water tank cap, and pour out the remaining water.
 - Be sure to pour out the remaining water after each use.

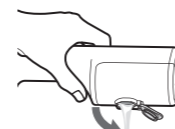

- Turn on the power switch (ⓘ) to drain the remaining water in the main unit.
- Turn off the power switch (ⓘ) when no more water comes out.

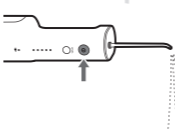

- Pull out the nozzle while pressing the nozzle release button.

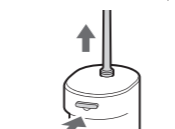

- Pull out the water tank downwards.



2 Clean with water.

- The water tank can be washed in a dishwasher.
- Do not hit the product on the washstand when draining.



3 Store the appliance after drying.

- Wipe any water away from the nozzle, water tank and the main unit with a towel or something similar, and dry them in a well-ventilated shade.



- Attach the water tank.

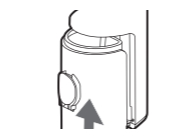

- Put the main unit upright on the charger.

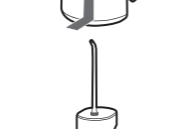

- **Notes**
- Do not wash with lukewarm water exceeding 50 °C (except the water tank).
 - Use neutral kitchen detergent and rinse well with water to ensure no detergent remains after cleaning.
 - Never use thinners, benzine, or alcohol. (Doing so may cause malfunction, or cracking or discoloration of the parts.)

When the water jet is poor
Remove the dirt from the filter (the tip of the suction hose). Rub the filter gently with a soft brush.



When dirt is a concern

Wipe the charger with a dry cloth. (Do not rinse it with water.)



Frequently asked questions

| Question | Answer |
|--|---|
| Will the battery deteriorate if not used for an extended period of time? | The battery will deteriorate if not used for over 6 months, so make sure to perform a full charge at least once every 6 months. |
| Can I charge the appliance after every use? | The battery used is a lithium-ion, so charging after every use will have no effect on battery life. |

Troubleshooting

Perform the following actions.
If the problems still cannot be solved, contact the store where you purchased the unit or a service center authorized by Panasonic for repair.

| Problem | Possible cause | Action |
|----------------|--|--|
| While charging | The low battery/charge status indicator does not light on. | <ul style="list-style-type: none"> Although the low battery/charge status indicator may not light on in the first several minutes of charging, it will light on as the charging proceeds. If it does not light on after a while, please request a repair at the store where you purchased the unit or Service Center. The main unit is not properly in contact with the charger. |
| | The low battery/charge status indicator flashes rapidly (twice a second). | <ul style="list-style-type: none"> Please charge within the recommended temperature range of 5 °C to 35 °C. If the low battery/charge status indicator flashes even when you charge it within the recommended temperature range, contact the store where you purchased the unit or Service Center for repair. |
| | The appliance can be used for just several minutes even after a full charge. | <ul style="list-style-type: none"> The main unit is not properly in contact with the charger. |
| | The low battery/charge status indicator does not flash, but the appliance stops working. | <ul style="list-style-type: none"> The battery has reached the end of its life (approx. 3 years). |
| While using | The appliance does not operate. | <ul style="list-style-type: none"> The battery has reached the end of its life (approx. 3 years). The appliance is used at approximately 5 °C or lower. |
| | The water jet is poor. | <ul style="list-style-type: none"> The nozzle is clogged. The outlet of nozzle is squashed. The filter is clogged. |
| | No water comes out. | <ul style="list-style-type: none"> The main unit is tilted too much. |
| | The nozzle is hard to install. | <ul style="list-style-type: none"> Apply water to the nozzle insertion port. |
| | | <ul style="list-style-type: none"> Have the battery replaced by the store where you purchased the unit or an authorized service center. Do not use the appliance at approximately 5 °C or lower. Replace the nozzle with a new one. Remove the dirt from the filter. Please use the appliance with the main unit upright. It may take some time to suck up water. |

Battery life

Approximately 3 years. The battery may have reached its operating life if the usage frequency decreases drastically, even after a full charge. (The operating life of the battery may differ depending on usage or storage conditions.)

Disposal of the appliance

- Remove the built-in rechargeable battery before disposing of the appliance.**
- The battery is to be disposed of safely.
 - Please make sure that the battery is disposed of at an officially designated location if there is one.

How to remove the battery

This figure must only be used when disposing of the appliance, and must not be used to repair it. If you dismantle the appliance yourself, it will no longer be waterproof, which may cause it to malfunction.

- Remove the main unit from the charger, press the power switch to turn on the power and then keep the power on until the battery is completely discharged.
- Perform steps ① to ⑤ to disassemble the main unit and remove the battery with a screwdriver.
- Insulate the + and - terminals by applying tape to them. (To prevent short circuit of terminals).

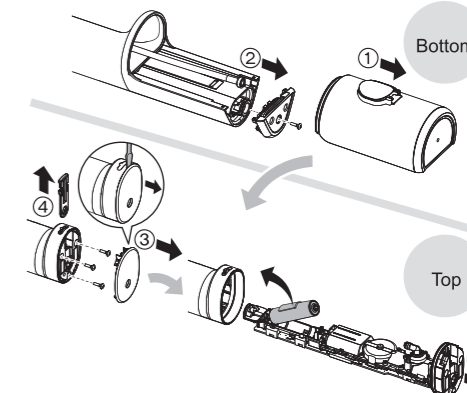

For environmental protection and recycling of materials

This appliance contains a Lithium-ion battery. Please make sure that the battery is disposed of at an officially assigned location, if there is one in your country.

Specifications

| | |
|----------------|---|
| Power source | See the name plate on the product (Automatic voltage conversion) |
| Charging time | Approx. 17 hours |
| Operating time | LEVEL 5: Approx. 10 minutes (at 20 °C when fully charged) |
| Tank volume | Approx. 200 mL (For approx. 50 seconds of operation when the water pressure level is set to 5) |
| Dimensions | Main unit: 219 (H) x 63 (W) x 80 (D) mm (Not including nozzle) Charger: 37 (H) x 86 (W) x 101 (D) mm |
| Mass | Main unit: Approx. 275 g (Including nozzle) Charger: Approx. 200 g |

This product is intended for household use only.

Changing the nozzle (Sold separately)

- The nozzle should be replaced once every 6 months or so due to hygiene reasons, even if it is not deformed.

| | New nozzle (tip) | Deformed (worn) nozzle (tip) |
|----------------|------------------|------------------------------|
| Regular nozzle | | |

| Part number | Replacement Nozzle (x2) | |
|-------------|-------------------------|--|
| WEW0987 | Regular nozzle | |