

Panasonic[®]

Operating Instructions

Digital Cordless Answering System

Model No. **KX-TGU120AZ**
 KX-TGU432AZ



Model shown is KX-TGU120.

Before initial use, see “Getting Started” on page 12.

Thank you for purchasing a Panasonic product.

Please read these operating instructions before using the unit and save them for future reference.

To use this unit in your country, first change the unit's region setting to match your country (page 50).

Table of Contents

Introduction

Model composition	3
Accessory information	4
Graphical symbols for use on equipment and their descriptions	5

Important Information

For your safety	6
Important safety instructions	9
For best performance	9
Other information	10
Specifications	10

Getting Started

Setting up	12
Controls	15
Display icons/Indicators	17
Turning the power on/off	18
Date and time	18
Recording your greeting message	18
Other settings	19

Making/Answering Calls

Making calls	21
Answering calls	22
Useful features during a call	22
Intercom	25
Key lock	26

Nuisance Call Block

Nuisance call block	28
Storing unwanted callers	28

Automated Call Block

Automated call block	31
----------------------------	----

Phonebook

Phonebook	34
Speed dial	36
Favourites Key	36

Programming

Menu list	38
Alarm	45
Do not disturb mode	46
Baby monitor	47
Other programming	49

Caller ID Service

Using Caller ID service	51
Caller list	52

Answering System

Answering system	54
Turning the answering system on/ off	54
Greeting message	55
Listening to messages	55
Advanced new message alerting features	57
Remote operation	59
Answering system settings	61

Useful Information

Voicemail service	63
Character entry	63
Error messages	66
Troubleshooting	66
Registering a unit	73
Warranty (New Zealand)	75
Warranty (Australia)	76

Index

Index.....	77
------------	----

Model composition

■ KX-TGU120 series



- Model shown is KX-TGU120.

■ KX-TGU430 series

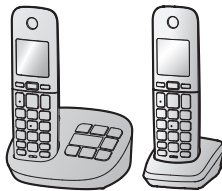

- Model shown is KX-TGU432.

Series	Model No.	Base unit	Handset	
		Part No.	Part No.	Quantity
KX-TGU120 series	KX-TGU120	KX-TGU120	KX-TGUA10	1
KX-TGU430 series	KX-TGU432	KX-TGU430	KX-TGUA40	2

Accessory information

Supplied accessories

No.	Accessory item/Part number	Quantity	
		KX-TGU120	KX-TGU432
①	AC adaptor for base unit/ PNLV226AL0X*1	1	1
②	Telephone line cord (for Australia)*2	1	1
③	Telephone line cord (for New Zealand)	1	1
④	Rechargeable batteries*3	2	4
⑤	Handset cover*4	1	2
⑥	Charger/PNLC1099ZB	–	1
⑦	AC adaptor for charger/ PNLV233ALKZ*1	–	1

*1 The AC adaptor is for use with information technology equipment only.

*2 The telephone line cord comes connected with the telephone plug.

*3 See page 5 for replacement battery information.

*4 The handset cover comes attached to the handset.

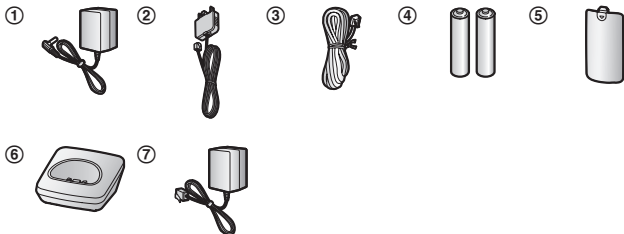

Additional/replacement accessories













Please contact your nearest Panasonic dealer for sales information.

Accessory item	Model number/Specifications
Rechargeable batteries	Battery type: – Nickel metal hydride (Ni-MH) – 2 x AAA (R03) size for each handset – 1.2 V

Other information

- Design and specifications are subject to change without notice.
- The illustrations in these instructions may vary slightly from the actual product.

Graphical symbols for use on equipment and their descriptions

Symbol	Explanation	Symbol	Explanation
	Alternating current (A.C.)		Class II equipment (equipment in which protection against electric shock relies on Double Insulation or Reinforced Insulation)
	Direct current (D.C.)		"ON" (power)
	Protective earth		"OFF" (power)
	Protective bonding earth		Stand-by (power)
	Caution, risk caused by visible radiation		"ON"/"OFF" (power; push-push)
	For indoor use only		Caution, risk of electric shock

For your safety

To prevent severe injury and loss of life/property, read this section carefully before using the product to ensure proper and safe operation of your product.

WARNING

Power connection

- Use only the power source marked on the product.
- Do not overload power outlets and extension cords. This can result in the risk of fire or electric shock.
- Completely insert the AC adaptor/power plug into the power outlet. Failure to do so may cause electric shock and/or excessive heat resulting in a fire.
- Regularly remove any dust, etc. from the AC adaptor/power plug by pulling it from the power outlet, then wiping with a dry cloth. Accumulated dust may cause an insulation defect from moisture, etc. resulting in a fire.
- Unplug the product from power outlets if it emits smoke, an abnormal smell, or makes an unusual noise. These conditions can cause fire or electric shock. Confirm that smoke has stopped emitting and contact an authorised service centre.
- Unplug from power outlets and never touch the inside of the product if its casing has been broken open.
- Never touch the plug with wet hands. Danger of electric shock exists.

Installation

- To prevent the risk of fire or electrical shock, do not expose the product to rain or any type of moisture.
- Do not place or use this product near automatically controlled devices such as automatic doors and fire alarms. Radio waves emitted from this product may cause such devices to malfunction resulting in an accident.
- Do not allow the AC adaptor or telephone line cord to be excessively pulled, bent or placed under heavy objects.
- Do not place the handset on the base unit when battery cover is removed.
- It is advised not to use the equipment at a refuelling point. Users are reminded to observe restrictions on the use of radio equipment in fuel depots, chemical plants or where blasting operations are in progress.

Operating safeguards

- Unplug the product from power outlets before cleaning. Do not use liquid or aerosol cleaners.
- Do not disassemble the product.
- Do not spill liquids (detergents, cleansers, etc.) onto the telephone line cord plug, or allow it to become wet at all. This may cause a fire. If the telephone line cord plug becomes wet, immediately pull it from the telephone wall socket, and do not use.
- To prevent hearing damage, make sure anyone who uses this product is aware that the product can produce very loud sounds, and

make sure children use this product only under adult supervision.

- To prevent hearing damage, we recommend that you set this product to the lowest volume setting at which you can hear adequately. Note that when the  is displayed, the Amplify key feature is enabled and the product may emit sounds at very high volume. (KX-TGU430 series: page 3)
- Avoid prolonged exposure to loud sounds produced by this product. Be aware that the louder a sound is, the less time is needed to cause hearing damage. In the event that you experience hearing discomfort, consult a medical professional.

Medical

- Consult the manufacturer of any personal medical devices, such as pacemakers or hearing aids, to determine if they are adequately shielded from external RF (radio frequency) energy. (The product operates in the frequency range of 1.88 GHz to 1.90 GHz, and the RF transmission power is 250 mW (max.).)
- Do not use the product in health care facilities if any regulations posted in the area instruct you not to do so. Hospitals or health care facilities may be using equipment that could be sensitive to external RF energy.

CAUTION

Installation and location

- Never install telephone wiring during an electrical storm.

- Never install telephone line sockets in wet locations unless the socket is specifically designed for wet locations.
- Never touch uninsulated telephone wires or terminals unless the telephone line has been disconnected at the network interface.
- Use caution when installing or modifying telephone lines.
- The AC adaptor is used as the main disconnect device. Ensure that the AC outlet is installed near the product and is easily accessible.
- This product is unable to make calls when:
 - the handset batteries need recharging or have failed.
 - there is a power failure.
 - the key lock feature is turned on.

Battery

- We recommend using the batteries noted on page 5. **USE ONLY rechargeable Ni-MH batteries AAA (R03) size.**
- Do not mix old and new batteries.
- Do not open or mutilate the batteries. Released electrolyte from the batteries is corrosive and may cause burns or injury to the eyes or skin. The electrolyte is toxic and may be harmful if swallowed.
- Exercise care when handling the batteries. Do not allow conductive materials such as rings, bracelets, or keys to touch the batteries, otherwise a short circuit may cause the batteries and/or the conductive material to overheat and cause burns.
- Charge the batteries provided with or identified for use with this product only, in accordance with the

Important Information

instructions and limitations specified in this manual.

- Only use a compatible base unit (or charger) to charge the batteries. Do not tamper with the base unit (or charger). Failure to follow these instructions may cause the batteries to swell or explode.
- Avoid the use in the following conditions:
 - High or low extreme temperatures during use, storage or transportation.
 - Replacement of a battery with an incorrect type that can defeat a safeguard.
 - Disposal of a battery into fire or a hot oven, or mechanically crushing or cutting of a battery, that can result in an explosion.
 - Extremely high temperature and/or extremely low air pressure that can result in an explosion or the leakage of flammable liquid or gas.

General notices

- This equipment will be inoperable when mains power fails.
- When a failure occurs which results in the internal parts becoming accessible, disconnect the power supply cord immediately and return this unit to an authorised service centre.
- To minimise the possibility of lightning damage, when you know that a thunderstorm is coming, we recommend that you:
 - Unplug the telephone line cord from the phone socket.
 - Unplug the AC adaptor from the AC power outlet.

- No “000” (for Australia), “111” (for New Zealand), and/or other calls can be made from this device during a mains power failure.
- The earpiece on the handset is magnetised and may retain small metallic objects.

Important notice:

- Under power failure conditions, this telephone may not operate. Please ensure that a separate telephone, not dependent on local power, is available for emergency use.

For New Zealand

- Disconnect the telephone connection before disconnecting the power connection prior to relocating the equipment, and reconnect the power first.
- This equipment shall not be set to make automatic calls to the National “111” Emergency Service.
- The unit’s answering system only responds to Distinctive Alert cadence(s) DA1 and DA3.
- Not all telephones will respond to incoming ringing when connected to the extension socket.
- This equipment may not provide for the effective hand-over of a call to another device connected to the same line.
- The grant of a Telepermit for any item of terminal equipment indicates only that Spark has accepted that the item complies with minimum conditions for connection to its network. It indicates no endorsement of the product by Spark, nor does it provide any sort of warranty. Above all, it provides no assurance that any item will work correctly in all respects with another item of Telepermitted equipment of a

different make or model, nor does it imply that any product is compatible with all of Spark's network services.

Important safety instructions

When using your product, basic safety precautions should always be followed to reduce the risk of fire, electric shock, and injury to persons, including the following:

1. Do not use this product near water for example, near a bathtub, washbowl, kitchen sink, or laundry tub, in a wet basement or near a swimming pool.
2. Avoid using a telephone (including a cordless type) during an electrical storm. There may be a remote risk of electric shock from lightning.
3. Do not use the telephone to report a gas leak in the vicinity of the leak.
4. Use only the power cord and batteries indicated in this manual. Do not dispose of batteries in a fire. They may explode. Check with local codes for possible special disposal instructions.

SAVE THESE INSTRUCTIONS

For best performance

Base unit location/avoiding noise

The base unit and other compatible Panasonic units use radio waves to communicate with each other.

- For maximum coverage and noise-free communications, place your base unit:

- at a convenient, high, and central location with no obstructions between the handset and base unit in an indoor environment.
- away from electronic appliances such as TVs, radios, personal computers, wireless devices, or other phones.
- facing away from radio frequency transmitters, such as external antennas of mobile phone cell stations. (Avoid putting the base unit on a bay window or near a window.)
- Coverage and voice quality depends on the local environmental conditions.
- If the reception for a base unit location is not satisfactory, move the base unit to another location for better reception.

Environment

- Keep the product away from electrical noise generating devices, such as fluorescent lamps and motors.
- The product should be kept free from excessive smoke, dust, high temperature, and vibration.
- The product should not be exposed to direct sunlight.
- Do not place heavy objects on top of the product.
- When you leave the product unused for a long period of time, unplug the product from the power outlet.
- The product should be kept away from heat sources such as heating devices, cooking appliances, etc. It should not be placed in rooms where the temperature is less than 0 °C or greater than 40 °C. Damp basements should also be avoided.

Important Information

- The maximum calling distance may be shortened when the product is used in the following places: Near obstacles such as hills, tunnels, underground, near metal objects such as wire fences, etc.
- Operating the product near electrical appliances may cause interference. Move away from the electrical appliances.

Routine care

- **Wipe the outer surface of the product with a soft moist cloth.**
- Do not use benzine, thinner, or any abrasive powder.

Other information

- The applied nameplate is located at the bottom or rear of the product.

⚠ CAUTION: Risk of explosion if battery is replaced by an incorrect type. Dispose of used batteries according to the instructions.

Notice for product disposal, transfer, or return

- This product can store your private/confidential information. To protect your privacy/confidentiality, we recommend that you erase information such as phonebook or caller list entries from the memory before you dispose of, transfer, or return the product.

Information on Disposal in other Countries outside the European Union

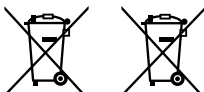

These symbols are only valid in the European Union. If you wish to discard these items, please contact your local authorities or dealer and ask for the correct method of disposal.

Note for the battery removal procedure

Refer to “Removing the battery” on page 13.

Specifications

- **Standard:**
DECT (Digital Enhanced Cordless Telecommunications),
GAP (Generic Access Profile)
- **Frequency range:**
1.88 GHz to 1.90 GHz
- **RF transmission power:**
Approx. 10 mW (average power per channel)
250 mW (max.)
- **Power source:**
220 – 240 V AC, 50/60 Hz
- **Rechargeable battery:**
AAA (R03) Ni-MH battery (1.2 V, 550 mAh)

- **Power consumption:**

- **Base unit:**

- Standby: 0.8 W

- Maximum: 2.7 W

- **Charger:**

- Standby: 0.2 W

- Maximum: 1.2 W

- **Operating conditions:**

- 0 °C–40 °C, 20 %–80 % relative air
humidity (dry)

Setting up

Connections

■ Base unit

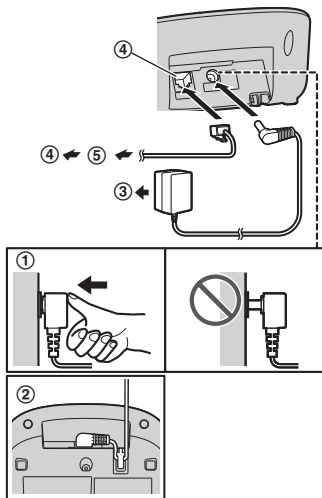

- ① Connect the AC adaptor to the unit by pressing the plug firmly.
- ② Fasten the cord by hooking it.
- ③ Connect the AC adaptor to the power outlet.
- ④ Connect the telephone line cord to the unit, then to the telephone line socket until you hear a click.
- ⑤ A DSL/ADSL filter (not supplied)*1 is required if you have a DSL/ADSL service.

*1 For Australia: Connect a DSL/ADSL filter between the telephone plug and telephone line cord.

Note:

- Use only the supplied Panasonic AC adaptor PNLV226AL.
- Use only the supplied telephone line cord.

■ Charger

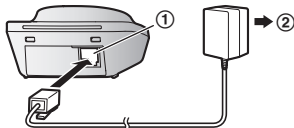

- ① Connect the AC adaptor plug to the unit until you hear a click.
- ② Connect the AC adaptor to the power outlet.

Note:

- Use only the supplied Panasonic AC adaptor PNLV233AL.

Battery installation

- USE ONLY rechargeable Ni-MH batteries AAA (R03) size (A).
- Do NOT use alkaline/manganese/ Ni-Cd batteries.
- Confirm correct polarities (+, -).

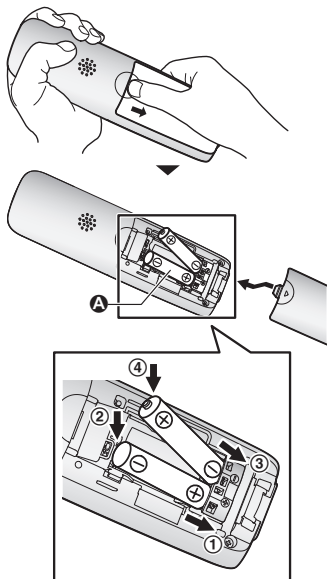

- Follow the directions on the display to set up the unit.

Removing the battery

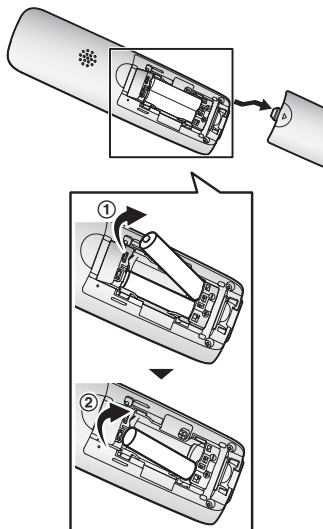

Battery charging

Charge for about 7 hours.

- Confirm “Charging” is displayed (A).
- When the batteries are fully charged, “Fully Charged” is displayed.

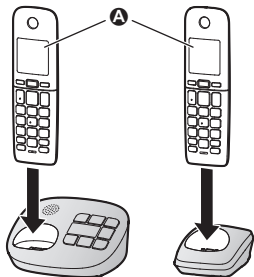

Model shown is KX-TGU432.

Note when setting up

Note for connections

- The AC adaptor must remain connected at all times. (It is normal for the adaptor to feel warm during use.)
- The AC adaptor should be connected to a vertically oriented AC outlet. Do not connect the AC adaptor to a horizontally oriented AC outlet that faces the floor, such as an AC outlet installed on a ceiling or under a table, as the weight of the adaptor may cause it to become disconnected.
- The unit is not designed to be used with rotary/pulse dialling services.

- The unit's answering system will not answer incoming calls on your FaxAbility number. (for New Zealand)

Power failure

- The unit cannot be used to make or receive calls during a power failure. We recommend connecting a corded-type telephone that does not use an AC adaptor to your telephone line.

Note for battery installation

- Use the supplied rechargeable batteries. For replacement, we recommend using the Panasonic rechargeable batteries noted on page 5, 7.

Note for battery charging

- It is normal for the handset to feel warm during charging.
- Clean the charge contacts of the handset, base unit, and charger with a soft and dry cloth once a month. Before cleaning the unit, disconnect from power outlets and any telephone line cords. Clean more often if the unit is exposed to grease, dust, or high humidity.

Battery level

Icon	Battery level
	High
	Medium
	Low
	Needs charging.

Ni-MH battery performance (supplied batteries)

Operation	Operating time
In continuous use	18 hours max.*1, *2
Not in use (standby)	250 hours max.*1, *2

*1 When eco mode is on.

*2 When torchlight or Amplify key feature is off. (KX-TGU430 series: page 3)

Note:

- Actual battery performance depends on usage and ambient environment.

Controls

Base unit

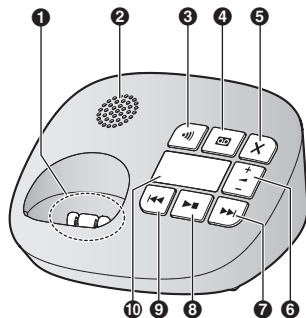

- Charge contacts**
- Speaker**
- [📞]** (Locator)
 - You can locate a misplaced handset by pressing [📞].
- [📞]** (Answer on/off)

- [X]** (Erase)
- [+]/[-]** (▲: Volume up/down)
- [▶▶]** (Skip)
- [▶■]** (Play/Stop)
- [◀◀]** (Repeat)
- Message indicator (—)**
- Answer on/off indicator (—)*1**
- Message counter*2**

*1 KX-TGU120 series: page 3

*2 KX-TGU430 series: page 3

Handset

■ KX-TGU120 series: page 3

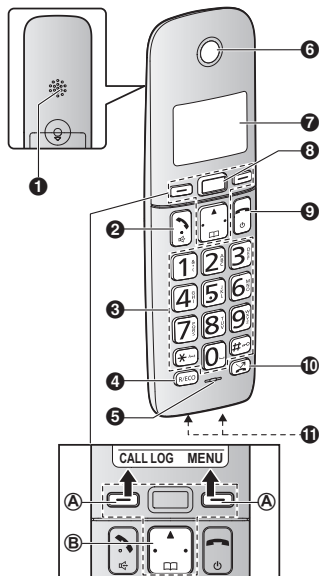

- Speaker**

Getting Started

- 2 (Talk/Speakerphone)
- 3 Dial keypad
 (Key lock)
- 4 (R/ECO)
R: Recall/Flash
ECO: Eco mode shortcut key
- 5 Microphone
- 6 Receiver
- 7 Display
- 8 Favourites Key (Favourites call)
Favourites Key indicator
- 9 (Off/Power)
- 10 (Call block)
- 11 Charge contacts

■ KX-TGU430 series: page 3

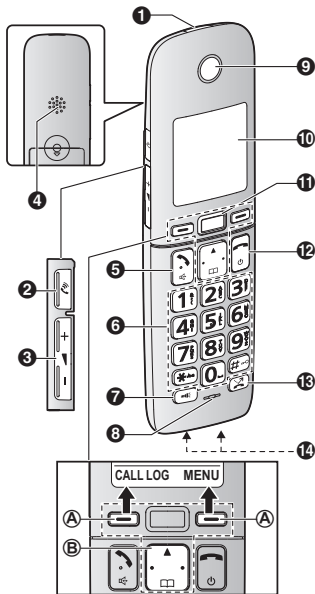

- 1 Torchlight/Ringer indicator
- 2 (Amplify key)
- 3 (+)/(-) (▲: Volume up/down)
- 4 Speaker
- 5 (Talk/Speakerphone)
- 6 Dial keypad
 (Key lock)
- 7 (Torchlight)
- 8 Microphone
- 9 Receiver
- 10 Display
- 11 Favourites Key (Favourites call)
Favourites Key indicator
- 12 (Off/Power)
- 13 (Call block)
- 14 Charge contacts

■ Control type

Ⓐ Soft keys

By pressing a soft key, you can select the feature shown directly above it on the display.

Ⓑ Navigator key



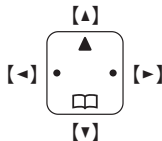







Navigator keys functions as follows.















- [▲], [▼], [◀], or [▶]: Scroll through various lists and items.
- [▲] or [▼] (▲): Adjust the receiver or speaker volume while talking.
- Right [●]: View the redial list.
- Left [●]: View the caller list.
- [☰] (Phonebook): View the phonebook entry.

Display icons/ Indicators

Handset display items

Item	Meaning
	Range status: The more bars visible, the closer the handset is to the base unit.
	Out of base unit range.
	Security for phone calls is set to "Enhanced".* ¹ (page 50)
	Paging, intercom mode.* ²
	Speakerphone is on. (page 21)
	The line is in use. <ul style="list-style-type: none"> • When flashing slowly: The call is on hold. • When flashing rapidly: An incoming call is now being received.
	Missed call.* ³ (page 51, page 70)
	Eco mode is set to "Eco". (page 19)
	Noise reduction is set. (page 24)
	The LCD and key backlight is off. (page 42)

Item	Meaning
	<ul style="list-style-type: none"> • When displayed near the battery icon: Answering system is on. (page 54) • When displayed with a number: New messages have been recorded. (page 56)
	"Greeting Only" is selected. Caller messages are not recorded. (page 62)
	Battery level.
	Amplify key feature is on.* ¹ (page 23)
	Alarm is on. (page 45)
	Privacy mode is on.* ² (page 42)
	Ringer volume is off. (page 40)
	Do not disturb mode is on. (page 46)
	Nuisance call blocked.* ³ (page 28)
	Automated call block is set to "Block". (page 32)
	Automated call blocked.* ³ (page 52)
	New voicemail message received.* ⁴ (page 63)

Item	Meaning
	Baby monitor is activated. The name/number displayed next to the icon indicates the monitoring unit.*1 (page 47)
Line in use	Someone is using the line.*2
IN USE	Answering system is being used by another unit.

*1 KX-TGU430 series: page 3

*2 KX-TGU432

*3 Caller ID subscribers only

*4 Voicemail subscribers only



Base unit display items (KX-TGU430 series)

Item	Meaning
--	<ul style="list-style-type: none"> “Greeting Only” is selected. Caller messages are not recorded. (page 62)
-	<ul style="list-style-type: none"> No messages.

Favourites Key indicators on the handset

Status	Meaning
Flashing	There is a missed call from a favourite contacts.
Flashing rapidly	An incoming call from a phone number registered in favourite contacts.



Handset soft key icons

Icon	Action
OK	Accepts the current selection.
	Temporarily turns off the ringer for incoming calls. (page 22)
	Turns the key lock feature off. (page 26)

Turning the power on/off

Press [] for about 2 seconds.

Date and time

- [MENU]#101
- Enter the current date, month, and year. → [OK]
Example: 12 July, 2024
 12 07 24
- Enter the current hour and minute.
Example: 9:30
 09 30
 - You can select 24-hour or 12-hour clock format (“AM” or “PM”) by pressing .
- [OK] → [

Recording your greeting message

You can record your own greeting message instead of using a

pre-recorded greeting message. See page 55 for details.

- 1 **[MENU]** **#** **3** **0** **2**
- 2 **[↕]**: “yes” → **[OK]**
- 3 Record a greeting message. → **[STOP]** → **[📞]**

Other settings

Eco mode

You can select the desired eco mode setting by pressing **[R/ECO]**.^{*1} The following settings are available for eco mode.

- “**Eco**”: Reduces the base unit transmission power by up to 90 % in standby mode.
When this setting is selected, **ECO** is displayed on the handset display instead of **Yil**.
- “**off**” (default setting): Turns off eco mode.
When this setting is selected, **ECO** are not displayed on the handset display.

*1 KX-TGU120 series: page 3

Setting the eco mode

- 1 **[MENU]** **#** **7** **2** **5**
- 2 **[↕]**: Select the desired setting. → **[OK]** → **[📞]**

Note:

- When there is another cordless phone in use nearby, the base unit transmission power may not be reduced. (KX-TGU432)
- When eco mode is active, the range of the base unit is reduced in standby mode.

Torchlight/Ringer indicator

Available for:

KX-TGU430 series: page 3

The indicator is located at the top of handset. There are two features available.

■ Torchlight

Press **[☞☞]** to turn the torchlight on/off. The maximum lighting time is about 5 minutes.

■ Ringer indicator

The LED flashes rapidly to indicate the unit status under the following conditions:

- an incoming call.
- intercom is being received.

The default setting is “on”.

- 1 **[MENU]** **#** **3** **4** **5**
- 2 **[↕]**: Select the desired setting. → **[OK]** → **[📞]**

Note:

- When the torchlight is turned on while receiving an incoming call, the ringer indicator will not work.

Low battery alert

When this feature is turned on, the unit notifies you by beeping 3 times at the selected interval if the battery needs charging when the handset is in standby mode.

Note for handset:

- At the end of each call, the unit displays a large icon for a few moments to indicate the battery level.

Setting low battery alert

To turn this feature on, select the desired alert interval, or select "Off" to turn this feature off. The default setting is "Every Hour".

- 1 **[MENU]** **#** **1** **7** **6**
- 2 **[↓]**: Select the desired setting. →
[OK] → **[🔊]**

Making calls

- 1 Lift the handset and then dial the phone number.
 - To correct a digit, press **[CLEAR]**.
- 2 Press **[📞/📞]** to make the call.
 - To make the call using the speakerphone, press and hold **[📞/📞]** for a few second.
- 3 When you finish talking, press **[📞]** or place the handset on the base unit or charger.

Note:

- While talking, you can switch between the receiver and the speakerphone by pressing **[📞/📞]**.
- In step 1, you can store the dialled phone number to the phonebook by pressing **[SAVE]**.

Adjusting the receiver or speaker volume

■ KX-TGU120 series: page 3

Press **[▲]** or **[▼]** on the navigator key repeatedly, to select the desired volume while talking.

■ KX-TGU430 series: page 3

Press either **[▲]** or **[▼]** on the navigator key, or **[+]** or **[-]** located on the side of the handset repeatedly, to select the desired volume while talking.

Note:

- If the receiver volume is set to level 5 (max.), it will be changed to level 4 in the next call. (KX-TGU120 series: page 3)
- Pressing the **[👉]** key activates the Amplify key feature. Use this key with care. To prevent hearing

damage, we recommend that you set this product to the lowest volume setting at which you can hear adequately (page 23).
(KX-TGU430 series: page 3)

Making a call using the redial list

The last 10 phone numbers dialled are stored in the redial list (24 digits max. each).

- 1 Press right **[●]** navigator key.
 - Or press **[CALL LOG]** (left soft key).
If the caller list is displayed, press right **[●]** navigator key to switch to the redial list.
- 2 **[↕]**: Select the desired entry.
- 3 **[📞/📞]**

Erasing a number in the redial list



- 1 Press right **[●]** navigator key.
 - Or press **[CALL LOG]** (left soft key).
If the caller list is displayed, press right **[●]** navigator key to switch to the redial list.
- 2 **[↕]**: Select the desired entry. → **[ERASE]**
- 3 **[↕]**: "Yes" → **[OK]** → **[📞]**

Pause (for PBX/long distance service users)

A pause is sometimes required when making calls using a PBX or long distance service. When storing a calling card access number and/or PIN in the phonebook, a pause is also needed (page 35).

Example: If you need to dial the line access number "0" when making outside calls with a PBX:

Making/Answering Calls



- 1  → [▲] (Pause)
- 2 Dial the phone number. →  / 

Note:

- A 3 second pause is inserted each time [▲] (Pause) is pressed.

Answering calls

When a call is being received, the ringer indicator flashes rapidly according to its settings.*1 (page 19)

- 1 Lift the handset and then press  when the unit rings.
- 2 When you finish talking, press  or place the handset on the base unit or charger.

*1 KX-TGU430 series: page 3

Any key answer: You can answer the call by pressing any dial key.

Auto talk: You can answer calls simply by lifting the handset (page 42).

Temporary handset ringer off: You can turn the ringer off temporarily by pressing  (left soft key).

Adjusting the ringer volume

Handset

■ KX-TGU120 series: page 3

Press [▲] or [▼] on the navigator key repeatedly, to select the desired volume while ringing.

- To turn the ringer off, press [▼] repeatedly.

■ KX-TGU430 series: page 3

Press either [▲] or [▼] on the navigator key, or [+] or [-] located on the side of the handset repeatedly, to select the desired volume while ringing.

- To turn the ringer off, press either [▼] or [-] repeatedly.

Base unit

Press [+] or [-] repeatedly to select the desired volume.



- To turn the ringer off, press and hold [-] until the unit beeps.

Note:

- To change the ringer volume and ringer tone for an outside call, see page 40.

Useful features during a call

Hold

- 1 Press [MENU] during an outside call.
- 2 : "Hold" → [OK]
- 3 To release hold, press .

Note:

- After holding for 10 minutes, the call is disconnected.

Mute

- 1 Press [MUTE] during a call.
- 2 To return to the call, press [MUTE].

Recall/flash

- KX-TGU120 series: page 3
Press [R/ECO]

■ KX-TGU430 series: page 3

Press **[MENU]** during an outside call.
→ **[↕]**: "Recall" → **[OK]**

Allows you to use the special features of your host PBX such as transferring an extension call, or accessing optional telephone services.

Note:

- To change the recall/flash time, see page 42.

For Call Waiting or Call Waiting Caller ID service users (for New Zealand)

To use call waiting or Call Waiting Caller ID, you must first subscribe with your phone service provider.

This feature allows you to receive calls while you are already talking on the phone. If you receive a call while on the phone, you will hear a call waiting tone.

If you subscribe to both Caller ID and Call Waiting with Caller ID services, the 2nd caller's information is displayed after you hear the call waiting tone on the handset.

- 1** To answer the 2nd call,
■ **KX-TGU120 series: page 3**
Press **[RECO]**

■ **KX-TGU430 series: page 3**
Press **[MENU]** during an outside call. → **[↕]**: "Recall" → **[OK]**
- 2** To switch between calls,
■ **KX-TGU120 series: page 3**
Press **[RECO]**

■ **KX-TGU430 series: page 3**
Press **[MENU]** during an outside call. → **[↕]**: "Recall" → **[OK]**

Note:

- Please contact your phone service provider for details and availability of this service in your area.

Amplify key feature

Available for:

KX-TGU430 series: page 3

This feature allows you to substantially increase the volume of the other party's voice. This feature can be set for each unit.

Amplify key feature is working under the following features:

- Making call (page 21).
- Answering call (page 22).
- Monitoring with a handset (page 47).
- Listening to message from handset (page 56).

WARNING







- This feature is designed for users who are hard of hearing. If other users use the phone, be sure to turn this feature off.
- Do not use this feature unnecessarily. High volume emitted from the product may cause hearing damage.
- Pressing the **[🔊]** key activates the Amplify key feature. Use this key with care. To prevent hearing damage, we recommend that you set this product to the lowest volume setting at which you can hear adequately.

Setting the amplify volume mode

- 1** **[MENU]**#**279**
- 2** **[↕]**: Select the desired setting. → **[OK]** → **[🔊]**

Making/Answering Calls

Turning the Amplify key feature on/off

- 1 Press  while on a call.
 - The unit displays .
- 2 Press either  or  on the navigator key, or  or  located on the side of the handset repeatedly, to select the desired volume while talking.

Note:

- When the amplify volume mode is set to “Normal”:
 - If the receiver volume is set to level 5 (max.), it will be changed to level 4 in the next call or after listening to messages.
 - If the Amplify key feature is on, it will be changed to off in the next call or after listening to messages.
- When the amplify volume mode is set to “Amplified”:
 - The previous receiver volume level and Amplify key feature on/off status will continue in the next call or after listening to messages.
- This feature is not available while using the speakerphone.

Handset noise reduction

This feature allows you to hear the voice of the person you are talking to more clearly, by reducing the surrounding noise coming from the other party's telephone.



- 1 Press **[MENU]** while talking.
- 2 : “Noise Reduction On” or “Noise Reduction Off” → **[OK]**

Note:

- Depending on the environment where this handset is being used, this feature may not be effective.
- This feature is not available while using the speakerphone.

Handset equalizer

This feature clarifies the voice of the person you are talking to, producing a more natural-sounding voice that is easier to hear and understand.

- 1 Press **[MENU]** while talking.
- 2 : “Equalizer” → **[OK]**
- 3 : Select the desired setting.
- 4 Press **[OK]** to exit.

Note:

- Depending on the condition and quality of your telephone line, this feature may emphasise existing line noise. If it becomes difficult to hear, select another setting.
- This feature is not available while using the speakerphone.

Call share

Available for: KX-TGU432

You can join an existing outside call. To join the conversation, press  when the other handset is on an outside call.

Note:

- When another user joins the conversation, the interrupt tone sounds.
- To prevent other users from joining your conversations with outside

callers, turn the privacy mode on (page 42).

Transferring calls, conference calls

Available for:
KX-TGU432

Outside calls can be transferred or a conference call with an outside party can be made between handsets in the same radio cell.

- 1 During an outside call, press **[MENU]**.
- 2 **[↕]**: “Intercom” → **[OK]**
- 3 **[↕]**: Select the desired unit. → **[OK]**
 - If you select “Voice Paging”, the call will be switched from the ear-receiver mode to the speakerphone mode.
- 4 Wait for the paged party to answer.
 - If the paged party does not answer,
 - press **[BACK]** to return to the outside call.
 - if you select “Voice Paging” in step 3, press **[🔊]** and then **[📞/🔊]** to return to the outside call.
- 5 **To complete the transfer:**
Press **[🔊]**.
To establish a conference call:
[MENU] → **[↕]**: “Conference” → **[OK]**
 - To leave the conference, press **[🔊]**. The other 2 parties can continue the conversation.
 - To put the outside call on hold: **[MENU]** → **[↕]**: “Hold” → **[OK]**

To resume the conference:

[MENU] → **[↕]**:

“Conference” → **[OK]**

- To cancel the conference:

[MENU] → **[↕]**: “Stop Conference” → **[OK]**

You can continue the conversation with the outside caller.

Intercom

Available for:
KX-TGU432

Intercom calls can be made between handsets in the same radio cell.

Note:

- When paging the handset, the paged handset beeps for 1 minute.
- If you receive an outside call while talking on the intercom, the interrupt tone sounds. To finish intercom, press **[🔊]**. To answer the call, press **[📞/🔊]**.
- To change the ringer volume and ringer tone for intercom, see page 40.

Making an intercom call

- 1 **[MENU]** → **[📞]**
- 2 **[↕]**: Select the desired unit or “Voice Paging”. → **[OK]**
 - If you select “Voice Paging”, speak into the microphone after the beep. Your voice will be heard using the speakers of all handsets, until a paged party answers your page or until you press **[🔊]**.

Making/Answering Calls



After the other party answers, the speakerphone mode is turned on.

- 3 When you finish talking, press .

Note:

- You cannot use voice paging if other units are in use.

Answering an intercom call



- 1 Press  to answer the page.
- 2 When you finish talking, press .

Turning auto intercom on/off

Available for:

KX-TGU430 series: page 3

This feature allows the handset to answer intercom calls automatically when it is called. You do not need to press . When this feature is set to “On”, the monitoring handset for the baby monitor feature (page 48) will also answer baby monitor calls automatically. The default setting is “Off”.

- 1 **[MENU]#273**
- 2 : Select the desired setting. → **[OK] → **

Note:

- This feature is not available for all handsets paging and voice paging even if it is turned on.

Key lock

The handset can be locked so that no calls or settings can be made. Incoming calls can be answered, but most other functions are disabled while the key lock is on.



You can select to lock the handset with or without a password. The default setting is “without Password”.

When you turn the key lock feature on,  is displayed.

Important:

- Turn the torchlight off (page 19) before turning on the key lock feature.
- Calls to emergency numbers cannot be made until key lock is turned off.

Setting the key lock mode

- 1 **[MENU]#246**
- 2 : Select the desired setting. → **[OK] → **

Turning the key lock on/off

■ Without a password:

Press  for about 3 seconds during standby mode.

■ With a password:

- 1 Press  for about 3 seconds during standby mode.
- 2 Enter your key lock password (4 digits). → **[OK]** 2 times
 - If you forget your password, see page 68.

Note:

- You can turn off the handset while the key lock is on. Depending on the settings, the state of the handset

may change when you turn on the handset again:

- Without a password: The key lock turns off.
- With a password: The key lock stays on.
- The following keys and operations are available when the key lock is on:
 - **[STOP]** to stop the alarm.
 - Without a password: During a call, all available features can be used as usual. When the call ends, the handset turns the key lock on again.
- When the key lock mode is set to “**with Password**”:
 - Dial keypad and right **[•]** navigator key (to view redial list) cannot be used during a call.
 - **[CALL]** (right soft key) is not available during chain dial (page 35).

Nuisance call block

You can press the  key in the following situations to disconnect the current call and add a phone number to the call block list:

- when an incoming call is being received
- when an incoming call is being recorded by the answering system
- when talking on an outside call

Once a phone number has been added to the call block list, the unit will block calls from that phone number in the future.

- 1 Press  under the situations shown above.
- 2 Confirm the call block number and press **[YES]**.
 - The call block number is stored in the call block list, “**Call Blocked**” is displayed, and then the call is disconnected.

Note:

- If the call has no phone number, the call is blocked but it is not stored in the call block list.
- The call block feature is not available for intercom calls or calls received by call waiting.
- Blocked calls are logged in the caller list.

Storing unwanted callers

The unit can block calls by storing the desired items in the call block list beforehand (Caller ID subscribers only).

- “**Single Number**”: The unit blocks calls from specific phone numbers stored in the call block list.
- “**Range of Numbers**”: The unit blocks calls that begin with a number stored in the call block list, such as a toll-free phone number prefix or certain area codes.
- “**Withheld**”: The unit blocks calls that have no phone number.

However, this option may not be available in the following situations:

- If the caller dials from an area which does not provide a Caller ID service.
- International calls.

Single phone numbers and ranges of numbers can be stored in the call block list up to 1,000 items in total.

Blocking unwanted callers:

When a call is received, the unit does not ring while the caller is being identified.



If the caller's phone number matches an entry in the call block list, the unit emits no sound to the caller, and disconnects the call.

Storing a single phone number

Important:

- You must include the area code when storing phone numbers in the call block list.

Adding call blocked numbers from the caller list

- 1 Press left  navigator key.
 - Or press **[CALL LOG]** (left soft key).
If the redial list is displayed, press left  navigator key to switch to the caller list.

- 2 [↕]: Select the desired entry to be blocked.
- 3 [↗] → [↕]: "Yes" → [OK] → [⏻]

Adding call blocked numbers manually

- 1 [↗]
- 2 [↕]: "Nuisance Call Block" → [OK]
- 3 [↕]: "Single Number" → [OK]
- 4 [MENU] → [↕]: "Add" → [OK]
- 5 Enter the phone number (24 digits max.). → [OK] → [⏻]

Storing a range of numbers

- 1 [↗]
- 2 [↕]: "Nuisance Call Block" → [OK]
- 3 [↕]: "Range of Numbers" → [OK]
- 4 [MENU] → [↕]: "Add" → [OK]
- 5 Enter the desired number (2-8 digits). → [OK] → [⏻]

Blocking incoming calls that have no phone number

You can block calls when no phone number is provided, such as private callers.

- 1 [↗]
- 2 [↕]: "Nuisance Call Block" → [OK]
- 3 [↕]: "Withheld" → [OK]
- 4 [↕]: Select the desired setting. → [OK] → [⏻]

Viewing/editing/erasing call block numbers

- 1 [↗]
- 2 [↕]: "Nuisance Call Block" → [OK]
- 3 [↕]: "Single Number" or "Range of Numbers" → [OK]
- 4 [↕]: Select the desired entry.
 - After viewing, press [⏻] to exit.
- 5 **To edit a number:**
[EDIT] → Edit the number. → [OK] → [⏻]
To erase a number:
[ERASE] → [↕]: "Yes" → [OK] → [⏻]

Note:







- When editing, press the desired dial key to add digits and press [CLEAR] to erase digits.

Erasing all call block numbers

- 1 [↗]
- 2 [↕]: "Nuisance Call Block" → [OK]
- 3 [↕]: "Single Number" or "Range of Numbers" → [OK]
- 4 [MENU] → [↕]: "Erase All" → [OK]
- 5 [↕]: "Yes" → [OK]
- 6 [↕]: "Yes" → [OK] → [⏻]

Displaying and clearing the blocked call count

The total number of blocked calls (up to 65,000) will be displayed.

- 1 [
- 2 []: "Nuisance Call Block"
→ [OK]
- 3 []: "Blocked Calls Count"
→ [OK]
 - To exit, press [].
- 4 [CLEAR]
- 5 []: "Yes" → [OK] → []

Automated call block

Automated call block means the unit screens incoming calls before ringing. If the call is allowed, the unit will ring. If the call is identified as an automated/telemarketing call, the unit will not ring. The unit will play a greeting message to the caller and prompt them to enter an access code.

This enables the unit to identify whether the call is automated. You can set the unit to block or unblock mode. The default setting is “Unblock”.

Note:

- The unit connects the call without prompting to enter access code in the following situations:
 - the caller's phone number matches an entry in the phonebook (page 34).
 - the caller's phone number matches an entry in the Favourites Key (page 36).
 - the caller's name matches an entry in the allow name list (page 32).
 - the caller's phone number is memorised in the allowed number database (page 31).
- If the number is stored in the call block list (page 28), the unit disconnects the call without playing the greeting message for automated call block.
- When the answering system answers a call from a caller who is not registered in the phonebook, Favourites Key, allow name list, or allowed number database, the following operations are delayed:
 - answering a call
 - remote turn on

- When the unit receives a call from a caller who is not registered in the phonebook, Favourites Key, allow name list, or allowed number database in the following situations, the unit shifts to standby mode:
 - when searching the phonebook, Favourites Key, caller list, call block list, or allow name list
 - when programming (depending on settings)
 - when using the answering system
 - when paging all handsets
- Blocked calls are logged in the caller list. We recommend you to check the caller list periodically. If necessary, register the entry to the phonebook, Favourites Key, or allow name list to connect the call next time.

Allowed number database

Once the caller enters the access code, the caller's phone number is memorised in the allowed number database as an unblocked number. Callers from this database are allowed to connect without the access code from their next call.

100 entries can be stored to the database (22 digits max. each).

Note:

- When the database memory is full, the latest call received will replace the oldest number stored in the list.
- The numbers stored in the database will be erased when you change the access code (page 32).
- The numbers stored in the database cannot be displayed.

Setting the automated call block

- 1 → [OK]
- 2 : "Block/Unblock" → [OK]
- 3 : Select the desired setting. → [OK]
- 4 : "Yes" → [OK] →

Note:

- We recommend you perform a test run of the automated call block procedure to ensure that the automated call block feature is set correctly.

Changing the access code

If the unit answers undesirable calls such as automated calls even though the automated call block function is on, change the access code (3 digits max.). The default setting is "1".

- 1 → [OK]
- 2 : "Access Code" → [OK]
- 3 [CLEAR]
- 4 Enter the new access code. → [OK] →

Displaying and clearing the blocked call count

The total number of blocked calls (up to 65,000) will be displayed.

- 1 → [OK]
- 2 : "Blocked Calls Count" → [OK]
 - To exit, press .
- 3 [CLEAR]
- 4 : "Yes" → [OK] →

Adding to the allow name list

You can allow specific callers to pass through by adding the caller's name to the allow name list even if you do not know the caller's number.

You can store up to 100 names (16 characters max.). If the name stored in the allow name list matches the incoming Caller ID, the unit rings. Callers listed in the allow name list are not required to enter the access code.

Adding allowed names from the caller list

- 1 Press left navigator key.
 - Or press [CALL LOG] (left soft key).
If the redial list is displayed, press left navigator key to switch to the caller list.
- 2 : Select the desired entry. → [MENU]
- 3 : "Save Allow Name" → [OK] →

Viewing/erasing an entry

- 1 → [OK]
- 2 : "Allow Name List" → [OK]
- 3 : Select the desired entry.
 - After viewing, press to exit.
- 4 [ERASE] → : "Yes" → [OK] →

Erasing all entries

- 1 → [OK]
- 2 : "Allow Name List" → [OK]

3 [ERASE] → [↕]: “Yes” → [OK]

4 [↕]: “Yes” → [OK] → [📞]

Greeting message for automated call block

When the unit answers a call, a greeting message is played to the caller.

You can use either:

- your own greeting message and pre-recorded greeting message.
- a pre-recorded greeting message.

Recording a personalised greeting message for automated call block

Using this feature, the unit can play your own greeting message and pre-recorded greeting message.

Example of your own greeting message:

“Hi, you have reached xxxxxx (Name).”

“Thank you for your calling, You have reached xxxxxx (Name).”

“Hi, you have reached the xxxxxx (Name) residence.”

1 [📞] → [OK]

2 [↕]: “Automated Call Greeting” → [OK]

3 [↕]: “Record Greeting” → [OK]

4 [↕]: “Yes” → [OK]

5 After a beep sounds, hold the handset about 20 cm away and speak clearly into the microphone (2 minutes 30 seconds max.).

6 Press [STOP] to stop recording.

7 The unit will play the recorded greeting message for automated call block. → [📞]

Resetting to the pre-recorded greeting message for automated call block

This procedure will erase your greeting message for automated call block and reset to the pre-recorded one.

1 [📞] → [OK]

2 [↕]: “Automated Call Greeting” → [OK]

3 [↕]: “Default” → [OK] 2 times → [📞]

Playing back the greeting message for automated call block

1 [📞] → [OK]

2 [↕]: “Automated Call Greeting” → [OK]

3 [↕]: “Play Greeting” → [OK]

4 To exit, press [📞].

Phonebook

You can add 100*1/200*2 names (16 characters max.) and phone numbers (24 digits max.) to the phonebook, and assign each phonebook entry to the desired category (page 34).

*1 KX-TGU120 series: page 3

*2 KX-TGU430 series: page 3

Important:

- All entries can be shared by any registered handset.

Adding phonebook entries

- 1 [□□] → [MENU]
- 2 [↕]: "New Entry" → [OK]
- 3 Enter the party's name. → [OK]
 - You can change the character entry mode by pressing [#] (page 63).
- 4 Enter the party's phone number. → [OK]
- 5 [↕]: Select the desired category. → [OK] 2 times → [🔇]

Note for New Zealand:

- Your phone service provider may charge you for a local call if the number dialled has the area code prefix included. If this is unacceptable, dial only the 7-digit local number. Do not dial the "0" prefix or the area code.

Storing a redial list number to the phonebook

- 1 Press right [•] navigator key.
 - Or press [CALL LOG] (left soft key).

If the caller list is displayed, press right [•] navigator key to switch to the redial list.

- 2 [↕]: Select the desired entry. → [SAVE]
- 3 To store the name, continue from step 3, "Editing entries", page 35.

Storing caller information to the phonebook

- 1 Press left [•] navigator key.
 - Or press [CALL LOG] (left soft key).
If the redial list is displayed, press left [•] navigator key to switch to the caller list.
- 2 [↕]: Select the desired entry. → [MENU]
- 3 [↕]: "Save Phonebook" → [OK]
- 4 To store the name, continue from step 3, "Editing entries", page 35.

Categories

Categories can help you find entries in the phonebook quickly and easily. You can change the names of categories ("Friends", "Family", etc.). By assigning different ringer tones for different categories of callers, you can identify who is calling (category ringer tone), if you have subscribed to Caller ID service.

Changing category names/setting category ringer tone

- 1 [□□] → [MENU]
- 2 [↕]: "Category" → [OK]
- 3 [↕]: Select the desired category. → [OK]

- 4 To change category names**
 [↕]: "Category Name" → [OK]
 → Edit the name (10 characters max.). → [OK]

To set category ringer tone
 [↕]: Select the current setting of the category ringer tone. → [OK]
 → [↕]: Select the desired ringer tone. → [OK]

- 5** [🔔]

Finding and calling from a phonebook entry

- 1** [☐]
- 2 To scroll through all entries**
 [↕]: Select the desired entry.
To search by first character
- Press the dial key ([0] to [9], or [#]) which contains the character you are searching for (page 63).
 - [↕]: Scroll through the phonebook if necessary.
- To search by category**
- [SEARCH] → [↕]: "Category" → [OK]
 - [↕]: Select the desired category. → [OK]
 - [↕]: Scroll through the phonebook if necessary.
- 3** [📞/📞]

Editing entries

- Find the desired entry (page 35). → [MENU]
- [↕]: "Edit" → [OK]
- Edit the name if necessary. → [OK]
- Edit the phone number if necessary. → [OK]

- 5** [↕]: Select the desired category (page 34). → [OK] 2 times → [🔔]

Erasing entries

Erasing an entry

- Find the desired entry (page 35). → [MENU]
- [↕]: "Erase" → [OK]
- [↕]: "Yes" → [OK] → [🔔]

Erasing all entries

- [☐] → [MENU]
- [↕]: "Erase All" → [OK]
- [↕]: "Yes" → [OK]
- [↕]: "Yes" → [OK] → [🔔]

Chain dial

This feature allows you to dial phone numbers in the phonebook while you are on a call. This feature can be used, for example, to dial a calling card access number or bank account PIN that you have stored in the phonebook, without having to dial manually.

- During an outside call, press [MENU].
- [↕]: "Phonebook" → [OK]
- Continue from step 2, "Finding and calling from a phonebook entry", page 35.
- Press [CALL] (right soft key) to dial the number.

Note:

- When storing a calling card access number and your PIN in the phonebook as one phonebook entry,

Phonebook

press [▲] (Pause) to add pauses after the number and PIN as necessary (page 21).

Speed dial

You can assign 1 phone number to each of the dial keys ([1] to [9]) on the handset.

Adding phone numbers to speed dial keys

■ By entering phone numbers:

- 1 Press and hold the desired speed dial key ([1] to [9]). → [ADD]
- 2 [↕]: "Manual" → [OK]
- 3 Enter the party's name (16 characters max.). → [OK]
- 4 Enter the party's phone number (24 digits max.). → [OK] 2 times → [📞]

■ From the phonebook:

- 1 Press and hold the desired speed dial key ([1] to [9]). → [ADD]
- 2 [↕]: "Phonebook" → [OK]
- 3 [↕]: Select the desired entry. → [OK] → [📞]

Note:

- If you edit a phonebook entry which is assigned to a speed dial key, the edited entry does not transfer to the speed dial key.

Editing an entry

- 1 Press and hold the desired speed dial key ([1] to [9]). → [MENU]

- 2 [↕]: "Edit" → [OK]
- 3 Edit the name if necessary. → [OK]
- 4 Edit the phone number if necessary. → [OK] 2 times → [📞]

Erasing an entry

- 1 Press and hold the desired speed dial key ([1] to [9]). → [MENU]
- 2 [↕]: "Erase" → [OK]
- 3 [↕]: "Yes" → [OK] → [📞]

Viewing an entry/Making a call

- 1 Press and hold the desired speed dial key ([1] to [9]).
- 2 To make a call, press [📞].

Favourites Key

You can add up to 3 favourite names (16 characters max.), phone numbers (24 digits max.) and the desired ringer tone to the Favourites Key. The Favourites Key indicator flashes once you have set your favourite contacts information (page 18).

Important:

- Make sure the unit's date and time setting is correct (page 18).
- This unit is Caller ID compatible. To use Favourites Key indicator and ringer tones features, you must subscribe to a Caller ID service. Contact your phone service provider for details.

Note:

- Favourite contacts are a common feature within the system.

Adding phone numbers manually to Favourites Key

- 1 [MENU]#295
- 2 [↕]: Select the desired entry. → [ADD]
- 3 Enter the party's name. → [OK]
- 4 Enter the party's phone number. → [OK]
- 5 [↕]: Select the desired ringer tone. → [OK] 2 times → [🔔]

Finding and calling from Favourites Key

- 1 Press Favourites Key.
- 2 [↕]: Select desired entry.
- 3 Press [📞] or Favourites Key to make the call.

Answering call from Favourites Key

- 1 Lift the handset and then press Favourites Key or [📞] when the unit rings.
- 2 When you finish talking, press [🔔].

Note:

- If there is a missed call from the favourite contacts, it will not be listed in the caller list. Instead, the Favourites Key will flash slowly to let you know there is a missed call from the favourite contacts.

To view:

- ① Press Favourites Key.
- ② [↕]: Select the desired entry. → [OK]

- If the indicator flashes when the handset is not placed on the base unit or charger, battery consumption will be faster than usual.

Editing a favourites caller's phone number

- 1 [MENU]#295
- 2 [↕]: Select desired entry. → [MENU]
- 3 [↕]: "Edit" → [OK]
- 4 Edit the name if necessary. → [OK]
- 5 Edit the phone number if necessary. → [OK]
- 6 [↕]: Select the desired ringer tone if necessary. → [OK] 2 times → [🔔]

Viewing the favourites information

- 1 [MENU]#295
- 2 [↕]: Select desired entry. → [MENU]
- 3 [↕]: "Detail" → [OK]
- 4 [🔔]

Erasing an entry

- 1 [MENU]#295
- 2 [↕]: Select desired entry. → [MENU]
- 3 [↕]: "Erase" → [OK]
- 4 [↕]: "Yes" → [OK] → [🔔]

Menu list

To access the features, there are 2 methods.

■ Scrolling through the display menus

- 1 [MENU]
- 2 Press [▼], [▲], [▶], or [◀] to select the desired main menu. → [OK]
- 3 Press [▼] or [▲] to select the desired item from the next sub-menus. → [OK]
- 4 Press [▼] or [▲] to select the desired setting. → [OK]

■ Using the direct command code

- 1 [MENU] → Enter the desired code.
Example: Press [MENU]#[1][0][1].
- 2 Select the desired setting. → [OK]

Note:

- To exit the operation, press [⏻].
- In the following table, < > indicates the default settings.
- In the following table,  indicates the reference page number.
- Display menu order and sub-menu may vary depending on your model.

Display the menu tree and direct command code table

Main menu:  "Answer System"

Sub-menu 1	Sub-menu 2	Settings	Code	
Play New Message	—	—	#323	56
Play All Message	—	—	#324	56
Erase All Message ^{*1}	—	—	#325	57
Greeting	Record Greeting ^{*1}	—	#302	55
	Play Greeting	—	#303	55
	Default ^{*1} (Reset to pre-recorded greeting)	—	#304	55

Sub-menu 1	Sub-menu 2	Settings	Code	
New Message Alert ^{*1,*2}	Outgoing Call – On/Off	On <Off>	#338	57
	Outgoing Call – Notification to	–		
	Outgoing Call – Remote Code	Activate <Inactivate>		
	Base Unit Beep	On <Off>	#339	57
Settings	Number of Rings ^{*1}	Auto 2-9 Rings <5 Rings>	#211	61
	Recording Time ^{*1}	<3 Minutes> 1 Minute Greeting Only ^{*4}	#305	62
	Remote Code ^{*1}	–	#306	59
	Call Screening	<On> Off	#310	61
Answer On ^{*1}	–	–	#327	54
Answer Off ^{*1}	–	–	#328	54

Main menu:  “Time Settings”

Sub-menu 1	Sub-menu 2	Settings	Code	
Set Date/Time ^{*1}	–	–	#101	18
Memo Alarm	Alarm1-3	<Off> Once Daily Weekly	#720	45
Time Adjustment ^{*1, *5}	–	<Caller ID> Manual	#226	–

Main menu:  “Intercom”^{*6}

Operation	Code	
Paging the desired unit.	#274	25

Programming

Main menu:  "Initial Setup"

Sub-menu 1	Sub-menu 2	Settings	Code	
Ringer Setup	Ringer Volume (External) – Handset	Off-6 <6>	#160	–
	Ringer Volume (External) – Base Unit	Off-6 <3>	#*160	–
	Ringer Volume (Intercom) (Handset)	1-6 <6>	#175	–
	Ringtone (External) ^{*7} (Handset)	<Ringtone 1>	#161	–
	Ringtone (Intercom) ^{*7} (Handset)	<Ringtone 6>	#163	–
	Do Not Disturb Mode – On/Off	On <Off>	#238	46
	Do Not Disturb Mode – Start/End	<23:00/06:00>	#237	46
	Do Not Disturb Mode – Ring Delay	30 sec. <60 sec.> 90 sec. 120 sec. No Ringing	#239	46
	Do Not Disturb Mode – Select Category	Favourite 1-3 Category 1-9	#241	46
	First Ring ^{*1, *8}	<On> Off	#173	–
	Ringer Indicator ^{*2}	<On> Off	#345	19

Sub-menu 1	Sub-menu 2	Settings	Code		
Time Settings	Set Date/Time ^{*1}	–	#101	18	
	Memo Alarm – Alarm1-3	<Off> Once Daily Weekly	#720	45	
	Time Adjustment ^{*1, *5}	<Caller ID> Manual	#226	–	
Amplify Volume Mode ^{*2}	–	<Normal> Amplified	#279	23	
Low Battery Alert	–	Off <Every Hour> Every 3 Hours Every 6 Hours	#176	19	
Automated Call Block ^{*1}	Block/Unblock	Block <Unblock>	#787	32	
	Allow Name List	–	#794	32	
	Access Code	<1>	#789	32	
	Automated Call Greeting	Record Greeting		#791	33
		Play Greeting		#792	33
		Default		#793	33
	Blocked Calls Count	–	#790	32	
Nuisance Call Block ^{*1}	Single Number	–	#217	28	
	Range of Numbers	–			
	Withheld	On <Off>	#240	29	
	Blocked Calls Count	–	#177	30	
Favourites Key ^{*1}	–	–	#295	36	
Speed Dial	–	–	#261	36	
Eco Mode ^{*1, *2}	–	<Off> Eco	#725	19	

Programming

Sub-menu 1	Sub-menu 2	Settings	Code	
Security ^{*1,*2}	–	<Normal> Enhanced	#729	50
Record Greeting ^{*1}	–	–	#302	55
Display Setup	LCD & Key Backlight	<On> Off	#276	–
	Contrast (Display contrast)	Level 1–4 <2>	#145	–
	Handset Name	–	#104	49
	Display Name	On <Off>	#105	49
Auto Intercom ^{*6}	–	On <Off>	#273	26
Keytones	–	<On> Off	#165	–
Area Code ^{*1}	–	–	#255	53
Key Lock Mode	–	with Password <without Password>	#246	26
Call Restrict ^{*1}	–	–	#256	49
Auto Talk ^{*9}	–	On <Off>	#200	22
Line Setup	Recall/Flash Time ^{*1,*10,*11}	80 msec. 90 msec. <100 msec.> 110 msec. 160 msec. 200 msec. 250 msec. 300 msec. 400 msec. 600 msec. 700 msec. 900 msec.	#121	22
Privacy Mode ^{*1,*6,*12}	–	On <Off>	#194	–

Sub-menu 1	Sub-menu 2	Settings	Code	
Base Unit PIN*1	–	<0000>	#132	50
Register	Register Handset	–	#130	73
	Cancel Register*4	–	#131	74
Country*1	–	<Australia> NewZealand	#136	50

Main menu: 🎵 “Ringer Setup”*3

Sub-menu 1	Sub-menu 2	Settings	Code	
Ringer Volume (External)	Handset	Off-6 <6>	#160	–
	Base Unit	Off-6 <3>	#*160	–
Ringer Volume (Intercom) (Handset)	–	1-6 <6>	#175	–
Ringtone (External)*7 (Handset)	–	<Ringtone 1>	#161	–
Ringtone (Intercom)*7 (Handset)	–	<Ringtone 6>	#163	–
Do Not Disturb Mode	On/Off	On <Off>	#238	46
	Start/End	<23:00/06:00>	#237	46
	Ring Delay	30 sec. <60 sec.> 90 sec. 120 sec. No Ringing	#239	46
	Select Category	Favourite 1-3 Category 1-9	#241	46
First Ring*1,*8	–	<On> Off	#173	–

Programming

Main menu: ☺ “Baby Monitor”^{*2}

Sub-menu 1	Sub-menu 2	Settings	Code	☞
On/Off	–	On <Off>	#268	47
Sensitivity Level	–	Low <Middle> High	#269	48

Main menu: ➔) “Caller List”

Operation	Code	☞
Viewing the caller list.	#213	52

- *1 If you program these settings using one of the handsets, you do not need to program the same item using another handset. (KX-TGU432)
- *2 KX-TGU430 series: page 3
- *3 KX-TGU120 series: page 3
- *4 This menu is not displayed when scrolling through the display menus. It is only available in direct command code.
- *5 This feature allows the unit to automatically adjust the date and time each time caller information including date and time is received.
To turn this feature on, select “**Caller ID**”. To turn this feature off, select “**Manual**”. (Caller ID subscribers only)
To use this feature, set the date and time first (page 18).
- *6 KX-TGU432
- *7 The preset melodies in this product (“**Ringtone 3**” - “**Ringtone 40**”) are used with the permission of © 2012 - 2017 Copyrights Vision Inc.
- *8 If you do not want the unit to ring before the caller information is received, set to “**Off**”. (Caller ID subscribers only)
You can only remove the first ring if the unit rings 2 times or more by default, which depends on your phone service provider.
- *9 If you subscribe to a Caller ID service and want to view the caller's information after lifting up the handset to answer a call, turn off this feature.
- *10 The recall/flash time depends on your telephone exchange or host PBX.
Contact your PBX supplier if necessary.
You can access your phone service provider “call waiting” service by having the recall/flash time set at “**100 msec.**”, and then follow your phone service provider “call waiting” instructions to operate this service. (for Australia)
- *11 The default setting will be as follows if you select the following regional code when changing the unit's region setting (page 50):
“**NewZealand**” = “**600 msec.**”

- *12 To prevent other users from joining your conversations with outside callers, turn this feature on.

Alarm

An alarm sounds at the set time for 1 minute and is repeated 5 times at 5 minute intervals (snooze function). A text memo can also be displayed for the alarm. A total of 3 separate alarm times can be programmed for each handset. You can set one of 3 different alarm options (once, daily, or weekly) for each alarm time.

Important:

- Make sure the unit's date and time setting is correct (page 18).

- 1 **[MENU][#][7][2][0]**
- 2 **[↕]**: Select the desired alarm. → **[OK]**
- 3 **[↕]**: Select the desired alarm option. → **[OK]**

<p>"Off" Turns alarm off. Go to step 9.</p>
--

<p>"Once" An alarm sounds once at the set time.</p>
--

<p>"Daily" An alarm sounds daily at the set time. Go to step 5.</p>
--

<p>"Weekly" Alarm sounds weekly at the set time(s).</p>
--

- 4 Proceed with the operation according to your selection in step 3.
 - **Once:**
Enter the desired date and month. → **[OK]**
 - **Weekly:**
[↕]: Select the desired day of the week and press **[SELECT]**. → **[OK]**
- 5 Set the desired time. → **[OK]**
- 6 Enter a text memo (10 characters max.). → **[OK]**
- 7 **[↕]**: Select the desired alarm tone. → **[OK]**
 - We recommend selecting a different ringer tone from the one used for outside calls.
- 8 **[↕]**: Select the desired snooze setting. → **[OK]**
- 9 **[OK]** → **[🔔]**

Note:

- Press **[STOP]** to stop the alarm completely.
- When the handset is in use, the alarm will not sound until the handset is in standby mode.
- Press any dial key or **[SNOOZE]** to stop the sound but keep the snooze function activated.
- If you want to make an outside call when the snooze function is activated, please stop the snooze function before making the call.

Do not disturb mode

Do not disturb mode allows you to select a period of time during which the handset will not ring for outside calls. This feature is useful for time periods when you do not want to be disturbed, for example, while sleeping. Do not disturb mode can be set for each handset. Using the phonebook's category feature (page 34), you can also select categories of callers whose calls override do not disturb mode and ring the handset (Caller ID subscribers only).

Important:

- Make sure the unit's date and time setting is correct (page 18).
- We recommend turning the base unit ringer off (page 22) in addition to turning do not disturb mode on.
- If you have set the alarm, the alarm sounds even if do not disturb mode is turned on.

Turning do not disturb mode on/off

- 1 **[MENU]#238**
- 2 **[↕]**: Select the desired setting. → **[OK]**
 - If you select "OFF", press **[🔇]** to exit.
- 3 Enter the desired hour and minute you wish to start this feature. → **[OK]**
- 4 Enter the desired hour and minute you wish to end this feature. → **[OK]** → **[🔇]**

Changing the start and end time

- 1 **[MENU]#237**

- 2 Continue from step 3, "Turning do not disturb mode on/off", page 46.

Setting the ring delay

This setting allows the handset to ring during do not disturb mode if the caller waits long enough. After the selected amount of time passes, the handset rings. If you select "No Ringing", the handset never rings during do not disturb mode.

- 1 **[MENU]#239**
- 2 **[↕]**: Select the desired setting. → **[OK]** → **[🔇]**

Note:

- When the answering system answers the call, this feature does not work.

Selecting categories to bypass do not disturb mode

- 1 **[MENU]#241**
- 2 **[↕]**: Select the desired categories. → **[SELECT]**
 - "✓" is displayed next to the selected category numbers.
 - To cancel the selected category: **[↕]**: Select the category. → Press **[SELECT]** again. "✓" disappears.
- 3 **[OK]** → **[🔇]**

Note:

- In addition to the phonebook categories, you can select 3 people registered in favourite contacts.

Baby monitor

Available for:

KX-TGU430 series: page 3

This feature allows you to listen in on a room where another handset is located, allowing you to easily monitor from different areas of the house or place. The monitored handset (placed in a baby's room, for example) will automatically call the monitoring handset or the phone number stored when it detects sound.

Important:

- Before using this feature, we recommend that you test this feature and adjust the baby monitor sensitivity as needed, especially if you plan to monitor from outside.
- This feature should not be used as a substitute for a medical or caregiver's supervision. It is the caregiver's responsibility to stay close enough to handle any eventuality.

Note:

- During the monitoring mode, battery consumption is faster than usual. We recommend leaving the monitored handset on the base unit or charger.
- The monitored handset never rings while it is being monitored. If the base unit is placed near the monitored handset, we recommend turning off the base unit ringer volume (page 22).

Setting the baby monitor

Perform the setting operation with the handset to be monitored (for example, the handset placed in a baby's room).

To monitor with a handset

The internal baby monitor feature is available between handsets in the same radio cell.

- 1 **[MENU]#268**
- 2 **[↕]: "On" → [OK]**
- 3 **[↕]:** Select the desired handset number to monitor with. → **[OK]**
 - "Baby Monitor" will be displayed.
 - The registered handset name/number is displayed.

Note:

- When this feature is on, another handset can hear the monitored handset by making an intercom call.

To monitor from an outside line

If you enable this feature, the unit will call a pre-programmed phone number when the handset detects sound. After you answer the call, you can listen in on the room where the handset is located.

■ From the phonebook:

- 1 **[MENU]#268**
- 2 **[↕]: "On" → [OK]**
- 3 **[↕]:** Select "External" to monitor from an outside line. → **[ADD]**
- 4 **[↕]: "Phonebook" → [OK]**
- 5 **[↕]:** Select the phonebook entry. → **[OK]**
 - "Baby Monitor" will be displayed.

Note:

- If you edit a phonebook entry which is assigned for monitoring, the edited entry does not transfer to the monitor.

■ By entering phone numbers:

- 1 **[MENU]** **#** **2** **6** **8**
- 2 **[↕]**: "On" → **[OK]**
- 3 **[↕]**: Select "External" to monitor from an outside line. → **[ADD]**
- 4 **[↕]**: "Manual" → **[OK]**
- 5 Enter the desired name. → **[OK]**
- 6 Enter the desired number. → **[OK]** 2 times
 - "Baby Monitor" will be displayed.

Note:

- The registered name/number is displayed.

Turning off the baby monitor

The monitored handset cannot be used while baby monitor is set to "On".

- 1 Press **[MENU]** on the handset being monitored.
- 2 **[↕]**: "On/Off" → **[OK]**
- 3 **[↕]**: "Off" → **[OK]** → **[🔇]**

Editing an outside monitoring number

- 1 Press **[MENU]** on the handset being monitored.
- 2 **[↕]**: "On/Off" → **[OK]**
- 3 **[↕]**: "On" → **[OK]**
- 4 **[↕]**: Select the outside line.
- 5 **[MENU]** → **[↕]**: "Edit" → **[OK]**

- 6 Edit the name if necessary. → **[OK]**
- 7 Edit the phone number if necessary. → **[OK]** 2 times

Erasing an outside monitoring number

- 1 Press **[MENU]** on the handset being monitored.
- 2 **[↕]**: "On/Off" → **[OK]**
- 3 **[↕]**: "On" → **[OK]**
- 4 **[↕]**: Select the outside line.
- 5 **[MENU]** → **[↕]**: "Erase" → **[OK]**
- 6 **[↕]**: "Yes" → **[OK]** → **[🔇]**

Baby monitor sensitivity

You can adjust the sensitivity of the baby monitor. Increase or decrease the sensitivity to adjust the sound level needed to trigger the baby monitor feature.



- This feature cannot be set during a monitoring call.
- 1 Press **[MENU]** on the handset being monitored.
 - 2 **[↕]**: "Sensitivity Level" → **[OK]**
 - 3 **[↕]**: Select the desired setting. → **[OK]** → **[🔇]**

Answering the baby monitor

- **When monitoring with a handset:**
Press **[📞/🔇]** to answer calls.
If you want to respond from the monitoring handset, press **[MUTE]**.
 - The monitoring handset will answer calls automatically when



the auto intercom feature is set to “On” (page 26).



Note:

- If you receive an outside call when communicating with the monitored handset, the interrupt tone sounds. To answer the call, press , then press .

■ When monitoring from an outside line:

Answer the call.

If you want to respond from the monitoring phone, press   using tone dialling.

You can turn off the baby monitor feature by pressing  .

Note:





- The unit disconnects the call automatically after 2 minutes.

Other programming

Changing the handset name



The default handset name is “Handset 1” to “Handset 2”^{*1}. You can customise the name of each handset (“Bob”, “Kitchen”, etc.). This is useful when you make intercom calls between handsets. To display the handset name in standby mode, turn on the handset name display feature (page 49).

*1 KX-TGU430 series: page 3

- 1 **[MENU]**   
- 2 Enter the desired name (10 characters max.).
- 3 **[OK]** → 









Displaying the handset name

You can select whether or not the handset name is displayed in standby mode. The default setting is “OFF”.

- 1 **[MENU]**   
- 2 : Select the desired setting. → **[OK]** → 

Call restriction

You can restrict selected handsets from dialling certain numbers. You can assign up to 6 phone numbers to be restricted, and select which handsets are to be restricted. Storing area codes here prevents the restricted handsets from dialling any phone number in that area code.

- 1 **[MENU]**   
- 2 Enter the base unit PIN (default: “0000”).
 - If you forget your PIN, contact an authorised service centre.
- 3 : Select the handsets to be restricted. → **[SELECT]**
 - “✓” is displayed next to the selected handset numbers.
 - To cancel the selected handsets:
 - : Select the handset. → Press **[SELECT]** again. “✓” disappears.
- 4 **[OK]**
- 5 : Select a memory location. → **[OK]**
- 6 Enter the phone number or area code to be restricted (8 digits max.). → **[OK]** → 

Enhancing security for phone calls

You can increase the security of phone conversations by setting this feature to “Enhanced”. When “Enhanced” is selected,  is displayed. The default setting is “Normal”.

- 1 **[MENU]#729**
- 2 **[↕]**: Selected the desired setting.
→ **[OK]**
- 3 **[🔒]**

Note:

- When enhanced security is enabled, sound may cut in and out during conversations.

Changing the base unit PIN

Important:

- If you change the PIN (Personal Identification Number), please make note of your new PIN. The unit will not reveal the PIN to you. If you forget your PIN, contact an authorised service centre.

- 1 **[MENU]#132**
- 2 Enter the current 4-digit base unit PIN (default: “0000”).
- 3 Enter the new 4-digit base unit PIN. → **[OK]**
- 4 **[↕]**: “Yes” → **[OK]** → **[🔒]**

Changing the unit's region setting

- 1 **[MENU]#136**
- 2 **[↕]**: Select the desired country.
→ **[OK]**
“Australia” = Australia
“NewZealand” = New Zealand
- 3 **[↕]**: “Yes” → **[OK]** → **[🔒]**

Note:

- Changing the unit's region setting may cause the settings for your country or your customised settings to return to their default settings.

Using Caller ID service

Important:

- This unit is Caller ID compatible. To use Caller ID features (such as displaying caller phone number), you must subscribe to a Caller ID service. Contact your phone service provider for details.

For New Zealand

- For all local and national incoming calls, your display will show the area code (e.g. 09 for Auckland) or the mobile prefix (e.g. 021, 022 and 027) followed by the caller's telephone number. An Auckland caller's number will be displayed as 09XXXXXXXX. The seven X's represent the seven digits of the caller's telephone number. A caller from a 7-digit mobile number will be displayed as 021/022/027XXXXXXXX. For incoming international calls, your display may only show "0000".
For business users on a Centrex line, your display will show Centrex extension numbers in the shorter extension number format used within your company.
- The Caller ID information will not be presented on incoming fax calls if Spark FaxAbility is used.

Using toll services from Spark or another company (for New Zealand)

Your telephone company may charge you for a local call if the number dialled has the area code prefix included. If this is unacceptable, dial only the

7-digit local number. Do not dial the "0" prefix or the area code.

Caller ID features



When an outside call is being received, the caller information is displayed.

Caller information for the last 50 callers is logged in the caller list from the most recent call to the oldest.



- If the unit cannot receive caller information, the following is displayed:
 - "Out of Area": The caller dials from an area which does not provide a Caller ID service.
 - "Private Caller": The caller requests not to send caller information.
- If the unit is connected to a PBX system, caller information may not be properly received. Contact your PBX supplier.

Missed calls

If a call is not answered, the unit treats it as a missed call and  is displayed. This lets you know if you should view the caller list to see who called while you were away.

Even if only one missed call in the caller list is viewed (page 52),  disappears from the display. When you receive another new call,  is displayed again.

Note:

- Even when there are unviewed missed calls,  disappears from the standby display if the following operation is performed by one of the registered handsets:
 - Being replaced on the base unit or charger.
 - Pressing [].

Caller ID Service

Phonebook name display

When caller information is received and it matches a phone number stored in the phonebook, the stored name in the phonebook is displayed and logged in the caller list.

However, if the caller information matches a number in the Favourites Key, the stored name in the Favourites Key is displayed, but it will not be shown in the caller log.

Call waiting and Caller ID compatible (for Australia)

If you subscribe to Caller ID service, your handset displays the 2nd caller's information while talking. After you hear a call waiting tone, the caller's phone number will be displayed.

You can answer the 2nd call, keeping the 1st call on hold.

■ KX-TGU120 series: page 3

Follow your phone service provider instructions using **[R/ECO]**. (Recall/flash function)

■ KX-TGU430 series: page 3

Follow your phone service provider instructions. Press **[MENU]** during an outside call. → **[↕]**: "Recall" → **[OK]** (Recall/flash function)

- If the phone number is stored in the phonebook with its name, the caller's name will also be displayed.
- Please contact your phone service provider for details and availability in your area.

For Caller ID Type II users

When you receive a 2nd call during a conversation, you will hear a signal tone following the call waiting tone and

the conversation will be interrupted or muted for a short period of time.

This is not a fault of the product as these events are normal.

- The tones are generated by your phone service provider.

Caller list

Important:

- Make sure the unit's date and time setting is correct (page 18).

Viewing the caller list and calling back

- 1 Press left **[•]** navigator key.
 - Or press **[CALL LOG]** (left soft key).
If the redial list is displayed, press left **[•]** navigator key to switch to the caller list.
- 2 Press **[▼]** to search from the most recent call, or press **[▲]** to search from the oldest call.
- 3 To call back, press **[↶/☎]**.
To exit, press **[⏻]**.

Note:

- If **[▶]** is displayed in step 2, not all of the information is shown. To see the remaining information, press **[▶]**. To return to the previous screen, press **[◀]**.
- If the entry has already been viewed or answered, "✓" is displayed.
 - "☎" indicates the caller blocked by Nuisance call block.
 - "☎" indicates the caller blocked by Automated call block.
- If you do not want to dial the area code when making calls from the

caller list, you can store the area code which you want the unit to delete automatically (page 53).

Storing an area code to be deleted automatically

In some situations, phone numbers stored automatically in the caller list (page 52) will include area codes. If you do not want to dial the area code when making calls from the caller list, you can store the area code which you want the unit to delete automatically.

Example: You have stored the area code "09". If you make a call from the caller list to the phone number "09-456-7890", the unit dials "456-7890".

- 1 **[MENU]** **#** **2** **5** **5**
- 2 Enter an area code (5 digits max.).
→ **[OK]** → **[📞]**

Note for New Zealand:

- The use of this feature can prevent a National Call from being dialled. E.g., in the case of the South Island, the "03" will be omitted and will therefore prevent a National Call to other areas of the South Island.

Editing a caller's phone number

The caller's telephone number, which is sent to your telephone from your local telephone exchange, includes "0" and an area code prefix. For local calls, "0" and the area code prefix can be omitted. (for New Zealand)

- 1 Press left **[•]** navigator key.
 - Or press **[CALL LOG]** (left soft key).

If the redial list is displayed, press left **[•]** navigator key to switch to the caller list.

- 2 **[↕]**: Select the desired entry. → **[MENU]**
- 3 **[↕]**: "Edit & Call" → **[OK]**
- 4 Edit the number.
- 5 **[📞]**

Erasing selected caller information

- 1 Press left **[•]** navigator key.
 - Or press **[CALL LOG]** (left soft key).
If the redial list is displayed, press left **[•]** navigator key to switch to the caller list.
- 2 **[↕]**: Select the desired entry.
- 3 **[ERASE]** → **[↕]**: "Yes" → **[OK]**
→ **[📞]**

Erasing all caller information

- 1 Press left **[•]** navigator key.
 - Or press **[CALL LOG]** (left soft key).
If the redial list is displayed, press left **[•]** navigator key to switch to the caller list.
- 2 **[ERASE]** → **[↕]**: "Yes" → **[OK]**
→ **[📞]**

Answering system

The answering system can answer and record calls for you when you are unavailable to answer the phone. You can also set the unit to play a greeting message but not to record caller messages by selecting “**Greeting Only**” as the recording time setting (page 62).

Important:

- Make sure the unit's date and time setting is correct (page 18).
- The unit's answering system will not answer incoming calls on your FaxAbility number. (for New Zealand)

Memory capacity (including your greeting message)

The total recording capacity is about 18^h1/20^m2 minutes. A maximum of 64 messages can be recorded.

*1 KX-TGU120 series: page 3

*2 KX-TGU430 series: page 3

Note:

- When message memory becomes full:
 - “**Messages Full**” is shown on the handset display.
 - The message counter (KX-TGU430 series: page 3) on the base unit flashes while the answer on/off indicator (■) (KX-TGU120 series: page 3) on the base unit flashes rapidly, if the answering system is turned on.
 - **00** and the total number of new messages are not displayed on the handset even if the answering system is turned on.

- If you use the pre-recorded greeting message, the unit automatically switches to another pre-recorded greeting message asking callers to call again later.
- If you recorded your own greeting message, the same message is still announced to callers even though their messages are not recorded.

Turning the answering system on/off

The answering system is preset to on.

Base unit

Press **[00]** to turn on/off the answering system.

Handset

- 1 **To turn on:**
[MENU]#327
To turn off:
[MENU]#328
- 2 **[📞]**

Note for base unit and handset:

- When the answering system is turned on:
 - the message counter on the base unit displays the total number of messages (old and new) (KX-TGU430 series: page 3) while the answer on/off indicator (■) on the base unit lights up (KX-TGU120 series: page 3).
 - **00** is displayed on the handset.

Greeting message

When the unit answers a call, a greeting message is played to callers. You can use either:

- your own greeting message
- a pre-recorded greeting message

Recording your greeting message

- 1 **[MENU]** **#** **3** **0** **2**
- 2 **[↕]**: “Yes” → **[OK]**
- 3 After a beep sounds, hold the handset about 20 cm away and speak clearly into the microphone (2 minutes 30 seconds max.).
- 4 Press **[STOP]** to stop recording.
→ **[📞]**

Using a pre-recorded greeting message

The unit provides 2 pre-recorded greeting messages:

- If you reset to pre-recorded greeting or do not record your own greeting message, the unit plays a pre-recorded greeting asking callers to leave a message.
- If the message recording time (page 62) is set to “**Greeting only**”, callers’ messages are not recorded and the unit plays a different pre-recorded greeting message asking callers to call again.

Resetting to a pre-recorded greeting message

Use this procedure to erase your greeting message and use a pre-recorded one.

- 1 **[MENU]** **#** **3** **0** **4**
- 2 **[OK]** → **[📞]**

Playing back the greeting message

- 1 **[MENU]** **#** **3** **0** **3**
- 2 **[📞]**

Listening to messages

Important:

- When using the base unit or handset to listen to messages, the noise reduction feature (page 24) is activated automatically in spite of the setting (**NR** is not displayed).

Using the base unit

When new messages have been recorded, the message indicator **[_]** on the base unit flashes. Press **[▶■]**.

- During playback, the message indicator **[_]** on the base unit lights.
- If new messages have been recorded, the base unit plays back new messages.
- If there are no new messages, the base unit plays back all messages.

Answering System

Operating the answering system during playback

Key	Operation
[+] or [-]	Adjust the speaker volume
[◀◀]	Repeat message*1
[▶▶]	Skip message
[▶■]	Stop playback
[X]	Erase currently playing message

*1 If pressed within the first 5 seconds of a message, the previous message is played.

Rewinding the message

Available for:
KX-TGU430 series: page 3

Press and hold **[◀◀]** until the unit plays the desired part of the message.

- During rewinding, the base unit makes a continuous beeping sound. Rewinding speed may vary depending on the recorded message.
- At the beginning of the message, the unit plays the message at normal speed.

Fast-forwarding the message

Available for:
KX-TGU430 series: page 3

Press and hold **[▶▶]** until the unit plays the desired part of the message.

- During fast-forwarding, the base unit makes a continuous beeping sound. Fast-forwarding speed may vary depending on the recorded message.

- Even if you press and hold **[▶▶]** when the end of this message is played, the next message is played at normal speed.

Erasing all messages

Press **[X]** 2 times while the unit is not in use.

Using the handset

When new messages have been recorded, **00** is displayed on the handset with the total number of new messages.

- 1 To listen to new messages:
[MENU]#323
To listen to all messages:
[MENU]#324
- 2 When finished, press **[📞]**.

Note:

- To switch to the receiver, press **[📞]**. Note to set the lowest volume setting at which you can hear adequately.

Operating the answering system

[MENU] → 00 → [OK]

Key	Operation
[▲] or [▼] / [+] *1 or [-] *1	Adjust the receiver or speaker volume (during playback)
[1] or [◀]	Repeat message (during playback)*2
[2] or [▶]	Skip message (during playback)
[3]	Enter the "Settings" menu
[4]	Play new messages

Key	Operation
[5]	Play all messages
[6]	Play greeting message
[7][6]	Record greeting message
[8]	Turn answering system on
[MENU]	Pause message*3
[9] or [STOP]	Stop recording Stop playback
[0]	Turn answering system off
[*][4]*4	Erase currently playing message
[*][5]	Erase all messages
[*][6]	Reset to a pre-recorded greeting message

*1 KX-TGU430 series: page 3

*2 If pressed within the first 5 seconds of a message, the previous message is played.

*3 To resume playback:
[↕]: "Play" → [OK]

*4 You can also erase as follows:
[MENU] → [↕]: "Erase" → [OK] → [↕]: "Yes" → [OK]

Calling back (Caller ID subscribers only)

1 Press [MENU] during playback.

2 [↕]: "Call Back" → [OK]

■ Editing the number before calling back

1 Press [MENU] during playback.

2 [↕]: "Edit & Call" → [OK]

3 Edit the number. → [↶/↷]

Erasing all messages

1 [MENU][#][3][2][5]

2 [↕]: "Yes" → [OK] → [🔊]

Advanced new message alerting features

Available for:

KX-TGU430 series: page 3

Audible message alert

This feature allows the base unit to beep to inform you of a new message arrival when new messages are recorded. The base unit beeps 2 times every minute until you listen to the messages, if the "Base Unit Beep" setting is turned on. The default setting is "Off".

1 [MENU][#][3][3][9]

2 [↕]: Select the desired setting. → [OK] → [🔊]

New message alert by a call

This feature allows you to receive a notification by phone when new messages are recorded. The base unit calls a phone number you specify. You can then operate the answering system remotely to listen to the new message. To use this feature, you must:

- store a phone number to which the unit makes the call to.
- turn on the new message alert setting.

Answering System

After you answer the new message alert call, you can listen to messages from that call (page 59).

Important:

- A new message alert is stopped 1 minute after the unit starts to call. The unit will not retry the call even if the call is not answered.

Storing a phone number to which the unit makes an alert call

■ From the phonebook:

- 1 [MENU]# 3 3 8
- 2 [↕]: "Notification to" → [OK] → [ADD]
- 3 [↕]: "Phonebook" → [OK]
- 4 [↕]: Select the desired phonebook entry. → [OK] → [📞]

■ By entering a phone number:

- 1 [MENU]# 3 3 8
- 2 [↕]: "Notification to" → [OK] → [ADD]
- 3 [↕]: "Manual" → [OK]
- 4 Enter the desired name (16 characters max.). → [OK]
- 5 Enter the desired number (24 digits max.). → [OK] 2 times → [📞]

Turning on/off the new message alert setting

■ If the phone number is being stored:

- 1 [MENU]# 3 3 8
- 2 [↕]: "On/Off" → [OK]
- 3 [↕]: Select the desired setting. → [OK] → [📞]

■ If the phone number is not being stored:

- 1 [MENU]# 3 3 8
- 2 [↕]: "On/Off" → [OK]
 - If you select "Off", press [OK].
To exit, press [📞].
- 3 [↕]: "On" → [OK] → [ADD]
- 4 [↕]: "Phonebook" → [OK] → Continue from step 4, "Storing a phone number to which the unit makes an alert call", page 58.
or
[↕]: "Manual" → [OK] → Continue from step 4, "Storing a phone number to which the unit makes an alert call", 58.

Editing the set phone number

- 1 [MENU]# 3 3 8
- 2 [↕]: "Notification to" → [OK]
- 3 [MENU] → [↕]: "Edit" → [OK]
- 4 Edit the name if necessary (16 characters max.). → [OK]
- 5 Edit the phone number if necessary (24 digits max.). → [OK] 2 times → [📞]

Erasing the set phone number

- 1 [MENU]# 3 3 8
- 2 [↕]: "Notification to" → [OK]
- 3 [MENU] → [↕]: "Erase" → [OK]
- 4 [↕]: "Yes" → [OK] → [📞]
 - The new message alert setting is turned off.

Activating/inactivating the remote access code to play messages

If you activate this feature, you must enter the remote access code (page 59) to play the new message from the new message alert call. This is so that unauthorised parties cannot listen to your messages. The default setting is “Inactivate”.

- “Inactivate”: You can listen to the message by pressing **[4]** to play new messages (without entering the remote access code).
- “Activate”: You must enter your remote access code and then press **[4]** to play new message.

- 1 **[MENU]#[3][3][8]**
- 2 **[↕]: “Remote Code” → [OK]**
- 3 **[↕]: Select the desired setting. → [OK] → [🔌]**

Listening to messages

After you answer the new message alert, you can listen to the messages as follows.

- **When the remote access code is set to “Inactivate”:**
Press **[4]** to play the new message during the announcement.
- **When the remote access code is set to “Activate”:**
 - 1 Enter the remote access code (page 59) during the announcement.
 - 2 Press **[4]** to play the new message.

Note:

- Within 10 seconds after listening to new messages, you can press **[#][9]** during the call to turn off the new message alert by a call feature.

- Even if the unit makes a new message alert call, the handset redial list does not show the record.

Remote operation

Using a touch-tone phone, you can call your phone number from outside and access the unit to listen to messages or change answering system settings. The unit’s voice guidance prompts you to press certain dial keys to perform different operations.

Remote access code

A 3-digit remote access code must be entered when operating the answering system remotely. This code prevents unauthorised parties from listening to your messages remotely.

Important:

- In order to operate the answering system remotely, you must first set a remote access code.

- 1 **[MENU]#[3][0][6]**
- 2 To turn on remote operation, enter the desired 3-digit remote access code.
- 3 **[OK] → [🔌]**

Deactivating remote operation

Press **[*]** in step 2 on “Remote access code”, page 59.

- The entered remote access code is deleted.

Using the answering system remotely

- 1 Dial your phone number from a touch-tone phone.
- 2 After the greeting message starts, enter your remote access code.
- 3 Follow the voice guidance prompts as necessary or control the unit using remote commands (page 60).
- 4 When finished, hang up.

Voice guidance

During remote operation, the unit's voice guidance starts and prompts you to press **[1]** to perform a specific operation, or press **[2]** to listen to more available operations.

Note:

- If you do not press any dial keys within 10 seconds after a voice guidance prompt, the unit disconnects your call.

Remote commands

You can press dial keys to access certain answering system functions without waiting for the voice guidance to prompt you.

Key	Operation
[1]	Repeat message (during playback)*1
[2]	Skip message (during playback)
[4]	Play new messages
[5]	Play all messages
[6]	Play greeting message

Key	Operation
[7]	Record greeting message
[9]	Stop recording Stop playback
[0]	Turn answering system off
[*][4]	Erase currently playing message
[*][5]	Erase all messages
[*][6]	Reset to a pre-recorded greeting message (during greeting message playback)
[*][#]	End remote operation (or hang up)

- *1 If pressed within the first 5 seconds of a message, the previous message is played.

Turning on the answering system remotely

- 1 Dial your phone number from a touch-tone phone.
- 2 Let the phone ring 15 times.
 - A long beep is heard.
- 3 Enter your remote access code within 10 seconds after the long beep.
 - The greeting message is played back.
 - You can either hang up, or enter your remote access code again and begin remote operation (page 59).

Answering system settings

Call screening

While a caller is leaving a message, you can listen to the call through the handset's speaker. To adjust the speaker volume, press either [▲] or [▼] on the navigator key, or [⊕]^{*1} or [⊖]^{*1} located on the side of the handset repeatedly. You can answer the call by pressing [📞/🔊] on the handset. Call screening can be set for each handset. The default setting is "On".

*1 KX-TGU430 series: page 3

1 [MENU]#310

2 [⬆]: Select the desired setting. →
[OK] → [📞]

Number of rings before the unit answers a call

You can change the number of times the phone rings "Number of Rings" before the unit answers a call. You can select 2 to 9 rings, or "Auto".

The default setting is "5 Rings".

"Auto": The unit's answering system answers at the end of the 2nd ring when new messages have been recorded, or at the end of the 5th ring when there are no new messages. If you call your phone from outside to listen to new messages (page 60), you know that there are no new messages when the phone rings for the 3rd time. You can then hang up without being charged for the call.

1 [MENU]#211

2 [⬆]: Select the desired setting. →
[OK] → [📞]

For service provider voicemail subscribers (for Australia)

To receive voicemail and use the answering system properly, please note the following:

- "Voicemail" is a service provided by your phone service provider (page 63). You will need to first subscribe or activate this service through your phone service provider. Contact your phone service provider on how to operate this service and how you will be notified that you have messages on your voicemail. To use this service, you will be required to leave your answering machine off on your unit. This will allow the voicemail to receive any messages.
- To use the unit's answering machine rather than the voicemail service provided by your phone service provider, please contact your phone service provider to have it removed or deactivated permanently or temporarily. Alternatively you can leave this service connected and change the "Number of Rings" to a shorter duration on your unit so your unit's answering machine can pick up the call prior to the voicemail provided by your phone service provider.

For Call Minder or Voicemail subscribers (for New Zealand)

To receive Call Minder or Message Mailbox messages and use the unit's answering system properly, please note the following:

- "Call Minder" and "Message Mailbox" are services provided by your phone service provider (page 63). You will need to first subscribe or activate this service through your phone service provider. Contact your phone service provider on how to operate this service and how you will be notified that you have messages. To use this service you will be required to leave your answering machine off on your unit (page 54). This will allow the service to receive any messages.
- To use the unit's answering machine rather than the service provided by your phone service provider, please contact your phone service provider to have it removed or deactivated permanently or temporarily. Alternatively you can leave this service connected and change the "Number of Rings" to a shorter duration on your unit so your unit's answering machine can pick up the call prior to the service provided by your phone service provider.

Caller's recording time

You can change the maximum message recording time allowed for each caller. The default setting is "3 Minutes".

- 1 [MENU]#305
- 2 [↕]: Select the desired setting. →
[OK] → [🔊]

Selecting "Greeting Only"

You can select "Greeting Only" which sets the unit to announce a greeting message to callers but not record messages.

Select "Greeting Only" in step 2 on "Caller's recording time", page 62.

Note:

- When you select "Greeting Only":
 - If you do not record your own message, the unit will play the pre-recorded greeting-only message asking callers to call again later.
 - If you use your own message, record the greeting-only message asking callers to call again later (page 55).

Voicemail service

For New Zealand

To receive Call Minder or Message Mailbox messages, please note the following: "Call Minder" and "Message Mailbox" are automatic answering services offered by your phone service provider.

For Australia and New Zealand

In addition to your unit's answering system you may also have voicemail service from your phone service provider. Voicemail is an answering service that may be offered by your phone service provider. This service can also record calls when you are unavailable to answer the phone or when your line is busy. Messages are recorded on the phone company system and not on the unit's answering system.

- To use the voicemail service rather than the unit's answering system, turn off the answering system (page 54).

If you have unit's answering system set to on and also the voicemail enabled, the system with least amount of rings will record the message first.

Example:

If the unit's answering system is set to 5 rings (page 61) and the voicemail answering system provided by your phone company is set to 3 rings (call your service provider), the unit's answering system will record the incoming call first.

When you have new messages,  is displayed on the handset if message indication service is available. Please contact your phone service provider for details of this service.

Important:

- If  still remains on the display even after you have listened to new messages, turn it off by pressing and holding **[MENU]** for 3 seconds.
- To use the voicemail service provided by your phone service provider rather than the unit's answering system, turn off the answering system (page 54). For details, see page 61.

Character entry

The dial keys are used to enter characters and numbers. Each dial key has multiple characters assigned to it. The characters that can be entered depend on the character entry mode (page 64).

- Press **[◀]** or **[▶]** to move the cursor left or right.
- Press dial keys to enter characters and numbers.
- Press **[CLEAR]** to erase the character or number highlighted by the cursor. Press and hold **[CLEAR]** to erase all characters or numbers.
- Press **[x] (A→a)** to switch between uppercase and lowercase.

Useful Information

- To enter another character located on the same dial key, press [▶] to move the cursor to the next space, then press the appropriate dial key.
- If you do not press any dial key within 2 seconds after entering a character, the character is fixed and the cursor moves to the next space.

Character entry modes

The available character entry modes are Alphabet (ABC), Numeric (0-9), Greek (ABΓ), Extended 1 (AÄÅ), Extended 2 (ŠŠŠ), and Cyrillic (АБВ). When in these entry modes except Numeric, you can select which character is entered by pressing a dial key repeatedly.

When the unit displays the character entry screen:

[#] → [↕]: Select a character entry mode. → [OK]

Note:

- ◻ in the following tables represents a single space.

Alphabet character table (ABC)

0	1	2	3	4	5	6	7	8	9
◻ 0	# & ' () * , - . / 1	A B C 2	D E F 3	G H I 4	J K L 5	M N O 6	P Q R S 7	T U V 8	W X Y Z 9
		a b c 2	d e f 3	g h i 4	j k l 5	m n o 6	p q r s 7	t u v 8	w x y z 9

Numeric entry table (0-9)

0	1	2	3	4	5	6	7	8	9
0	1	2	3	4	5	6	7	8	9

Greek character table (ABΓ)

0	1	2	3	4	5	6	7	8	9
◻ 0	# & ' () * , - . / 1	A B Γ 2	Δ E Z 3	H Θ I 4	K Λ M 5	N Ξ O 6	Π Ρ Σ 7	T Υ Φ 8	X Ψ Ω 9

Extended 1 character table (AĂÄ)

0	1	2	3	4	5	6	7	8	9
̀ 0	# & ' () * , - . / 1	A Ä Å Â Ã Ä Å Æ B Ç 2	D E È É Ê Ë Ë F 3	G Ğ H I Ì Í Î Ï 4	J K L 5	M N Ñ O Ó Ô Õ Ö 6	P Q R S Ş ß 7	T U Û Ú Ü Û Ü V 8	W X Y Z 9
		a à á â ä å å æ b ç 2	d e è é ê ë ë f 3	g ğ h i ì í î ï 4	j k l 5	m n ñ o ó ô õ ö 6	p q r s ş ß 7	t u ù ú û ü ü v 8	w x y z 9

- The following are used for both uppercase and lowercase: ø Ŵ Ŷ

Extended 2 character table (SŠŠ)

0	1	2	3	4	5	6	7	8	9
̀ 0	# & ' () * , - . / 1	A Á Ä Å B C Č Ć 2	D Ď E É Ě ě F 3	G H I í 4	J K L ł Ł 5	M N Ń Ń Ó Ó Ō Ő 6	P Q R Ŕ Ŗ Ŗ Ś Š 7	T Ť U Ú Ů Ů ú v 8	W X Y ý Ÿ Z ž Ž 9
		a á ä Å b c Č Ć 2	d ě e é Ě ě f 3	g h i í 4	j k l ł Ł 5	m n Ń ň ó ó ō ő 6	p q r Ŕ Ŗ Ŗ Ś Š 7	t ť u ú ů ů ú v 8	w x y ý Ÿ z ž Ž 9

- The following are used for both uppercase and lowercase:

Ą Ć Ć Ę Ł Ł Ł Ń Ŕ Ś Š ů ŷ Ž Ž Ž

Cyrillic character table (АБВ)

0	1	2	3	4	5	6	7	8	9
̀ 0 Ґ Є І І Ÿ	# & ' () * , - . / 1	А Б В Г 2	Д Е Ж З 3	И Й К Л 4	М Н О П 5	Р С Т У 6	Ф Х Ц Ч 7	Ш Щ Ъ Ы 8	Ь Э Ю Я 9

Error messages

Display message	Cause/solution
Base no power or No link. Reconnect AC adaptor.	<ul style="list-style-type: none">● Confirm the base unit's AC adaptor is connected to the unit and the power outlet correctly.● The handset has lost communication with the base unit. Move closer to the base unit and try again.● Unplug the base unit's AC adaptor to reset the unit. Reconnect the adaptor and try again.● The handset's registration may have been cancelled. Re-register the handset (page 73).
Check Phone Line	<ul style="list-style-type: none">● Make sure that you are using the supplied telephone line cord.● The telephone line cord has not been connected yet or not connected properly. Check the connections (page 12).
Checking	<ul style="list-style-type: none">● The automated call block function is in operation. Try again later.
Error	<ul style="list-style-type: none">● Recording was too short. Try again.
Memory Full	<ul style="list-style-type: none">● The phonebook memory is full. Erase unwanted entries (page 35).● Message memory is full. Erase unwanted messages (page 56, 57).● The call block list memory is full. Erase unwanted entries (page 29).
Use rechargeable battery.	<ul style="list-style-type: none">● A wrong type of battery such as alkaline or manganese was inserted. Use only the rechargeable Ni-MH batteries noted on page 5, 7.
You must first subscribe to Caller ID.	<ul style="list-style-type: none">● You must subscribe to a Caller ID service. Once you receive caller information after subscribing to a Caller ID service, this message will not be displayed.

Troubleshooting

If you still have difficulties after following the instructions in this section, disconnect the base unit's AC adaptor and turn off the handset, then reconnect the base unit's AC adaptor and turn on the handset.

General use

Problem	Cause/solution
The handset does not turn on even after installing charged batteries.	<ul style="list-style-type: none"> ● Place the handset on the base unit or charger to turn on the handset.
The unit does not work.	<ul style="list-style-type: none"> ● Make sure the batteries are installed correctly (page 13). ● Fully charge the batteries (page 14). ● Check the connections (page 12). ● Unplug the base unit's AC adaptor to reset the unit and turn off the handset. Reconnect the adaptor, turn on the handset and try again. ● The handset has not been registered to the base unit. Register the handset (page 73).
The handset display is blank.	<ul style="list-style-type: none"> ● The handset is not turned on. Turn the power on (page 18).
I cannot hear a dial tone.	<ul style="list-style-type: none"> ● Make sure that you are using the supplied telephone line cord. Your old telephone line cord may have a different wiring configuration. ● The base unit's AC adaptor or telephone line cord is not connected. Check the connections. ● Disconnect the base unit from the telephone line and connect the line to a known working telephone. If the working telephone operates properly, contact our service personnel to have the unit repaired. If the working telephone does not operate properly, contact your phone service provider.
The base unit beeps.*1	<ul style="list-style-type: none"> ● New messages have been recorded. Listen to the new messages (page 55).
Error sound is heard when I press some keys on base unit.	<ul style="list-style-type: none"> ● Automated call block is being screened. Try again later.
I cannot use the intercom feature.*1	<ul style="list-style-type: none"> ● This feature is available between the handsets. Although the handset displays "Intercom" or "Auto Intercom", these features are not available for single handset models.
The unit does not emit the specified number of rings.	<ul style="list-style-type: none"> ● If the first ring is turned off, the number of rings decreases by 1 from the specified number of rings (page 40).

Useful Information



Problem	Cause/solution
Excessive use of the torchlight can reduce the battery life.*1	<ul style="list-style-type: none">● Continuous usage of the torchlight will reduce the battery life to 2 hours. <p>Note: Torchlight will automatically turn off after 5 minutes of usage. You can press the [☰☰] key to turn back on.</p>
Handset functions abnormally, such as: <ul style="list-style-type: none">● One-sided connection (only one party can hear the other).● No ring when receiving calls.● Complete inability to connect calls.	<ul style="list-style-type: none">● This could be due to temporary communication errors between the phone and the router/FritzBox.● Please reboot your router/FritzBox by unplugging it from the AC outlet, waiting for 10 seconds, and then plugging it back in. This may fix the problems.

*1 KX-TGU430 series: page 3

Menu list

Problem	Cause/solution
I cannot register a handset to a base unit.	<ul style="list-style-type: none">● You entered the wrong PIN. If you forget your PIN, contact an authorised service centre.
I cannot remember the key lock mode password.	<ul style="list-style-type: none">● If you forget your password, enter [*]7000 instead of your key lock password.

Battery recharge

Problem	Cause/solution
The handset beeps and/or  flashes.	<ul style="list-style-type: none">● Battery charge is low. Fully charge the batteries (page 14).
I fully charged the batteries, but <ul style="list-style-type: none">–  still flashes or– the operating time seems to be shorter.	<ul style="list-style-type: none">● Clean the battery ends (\oplus, \ominus) and the charge contacts with a dry cloth and charge again.● It is time to replace the batteries (page 13).

Making/answering calls, intercom

Problem	Cause/solution
<p>📶 is displayed.</p>	<ul style="list-style-type: none"> ● The handset is too far from the base unit. Move closer. ● The base unit's AC adaptor is not properly connected. Reconnect AC adaptor to the base unit. ● The handset is not registered to the base unit. Register it (page 73). ● Activating eco mode reduces the range of the base unit in standby mode. If required, turn eco mode off (page 19).
<p>Noise is heard, sound cuts in and out.</p>	<ul style="list-style-type: none"> ● You are using the handset or base unit in an area with high electrical interference. Re-position the base unit and use the handset away from sources of interference. ● Move closer to the base unit. ● If you use a DSL/ADSL service, we recommend connecting a filter (contact your DSL/ADSL service provider) to the telephone line between the base unit and the telephone line socket. Contact your DSL/ADSL provider for details. (for Australia) ● If you use a DSL/ADSL (JetStream) service, we recommend that you contact your DSL/ADSL service provider to have a DSL/ADSL Splitter installed. We do not recommend the use of generic DSL/ADSL filters. Contact your DSL/ADSL service provider for details. (for New Zealand)
<p>Sound quality seems to be getting worse.</p>	<ul style="list-style-type: none"> ● You have registered a handset that is not recommended. The clearest sound quality is only possible by registering the provided handset.
<p>The handset does not ring.</p>	<ul style="list-style-type: none"> ● The ringer volume is turned off. Adjust ringer volume (page 22, 40). ● Do not disturb mode is turned on. Turn it off (page 46).
<p>The base unit does not ring.</p>	<ul style="list-style-type: none"> ● The ringer volume is turned off. Adjust ringer volume (page 22).

Useful Information

Problem	Cause/solution
I cannot make a call.	<ul style="list-style-type: none">● You dialled a call restricted number (page 49).● The key lock feature is turned on. Turn it off (page 26).● The unit is not designed to be used with rotary/pulse dialling services.
I cannot use voice paging.	<ul style="list-style-type: none">● You cannot use voice paging if other units are in use.
I cannot hear other party's voice clearly during a conversation.	<ul style="list-style-type: none">● Press either [▲] on the navigator key, or [⊕]^{*1} located on the side of the handset repeatedly, to select the desired volume while talking.● Turn on the Amplify key feature by pressing [👉] while on a call (page 23). Note that volume will be increased substantially.*1

*1 KX-TGU430 series: page 3

Favourites Key

Problem	Cause/solution
The Favourites Key remains flashing.	<ul style="list-style-type: none">● The Favourites Key flashes when there is a missed call from any of your favourite contacts is received and not answered.
No notification of missed call from favourite contacts.	<ul style="list-style-type: none">● When there is a missed call from the favourite contacts, the Favourites Key flashes at 5 second intervals. Press the Favourites Key, if "→)" is displayed besides the favourite contacts that means you had a missed call from that contact. <p>Note: Once you press the Favourites Key to see the missed call and press [🔇], the Favourites Key will stop flashing.</p>

Caller ID

Problem	Cause/solution
Caller information is not displayed.	<ul style="list-style-type: none"> ● You must subscribe to a Caller ID service. Contact your phone service provider for details. ● If your unit is connected to any additional telephone equipment, remove and plug the unit directly into the wall socket. ● If you use a DSL/ADSL service, we recommend connecting a filter (contact your DSL/ADSL service provider) to the telephone line between the base unit and the telephone line socket. Contact your DSL/ADSL provider for details. (for Australia) ● If you use a DSL/ADSL (JetStream) service, we recommend that you contact your DSL/ADSL service provider to have a DSL/ADSL Splitter installed. We do not recommend the use of generic DSL/ADSL filters. Contact your DSL/ADSL service provider for details. (for New Zealand) ● Other telephone equipment may be interfering with this unit. Disconnect the other equipment and try again. (for Australia) ● Other telephone equipment such as a monitored Burglar Alarm or the modem in the SKY Digital decoder may be interfering with this unit. Disconnect the other equipment and try again. (for New Zealand)
Caller information is displayed or announced* ¹ late.	<ul style="list-style-type: none"> ● Depending on your phone service provider, the unit may display the caller's information at the 2nd ring or later. Set the first ring to "OFF" (page 40). ● Move closer to the base unit.
Caller information is not announced.* ¹	<ul style="list-style-type: none"> ● The handset or base unit's ringer volume is turned off. Adjust it (page 22, 40). ● Depending on the number of rings setting, the answering system may answer calls before announcing the caller information. Select a different setting (page 61).
Time on the unit has shifted.	<ul style="list-style-type: none"> ● Incorrect time information from incoming Caller ID changes the time. Set the time adjustment to "Manual" (off) (page 41).

Useful Information

Problem	Cause/solution
The name stored in the phonebook is not fully displayed while an outside call is being received.	<ul style="list-style-type: none">● Edit the phonebook entry name to fit in 1 line of text (page 35).
The following features are not available: <ul style="list-style-type: none">● Phonebook.● CLIP (Caller Line Identification Presentation).● Date and time display (not available or incorrect).	<ul style="list-style-type: none">● If the handset is directly registered to the router/FritzBox, these features may not be available.● Connect the base unit to an analog port on the router/FritzBox, and then register the handset to the base unit.● If connecting the base unit to the router/FritzBox is not feasible, please refer to the manual of the router/FritzBox or contact the manufacturer for potential workarounds or alternative solutions.

*1 KX-TGU430 series: page 3

Answering system

Problem	Cause/solution
The unit does not record new messages.	<ul style="list-style-type: none">● The answering system is turned off. Turn it on (page 54).● The message memory is full. Erase unwanted messages (page 56).● The recording time is set to “Greeting Only”. Change the setting (page 62).● Your phone service provider’s voicemail service may be answering your calls before the unit’s answering system can answer your calls. Change the unit’s number of rings setting (page 61) to a lower value, or contact your phone service provider.
I cannot operate the answering system remotely.	<ul style="list-style-type: none">● The remote access code is not set. Set the remote access code (page 59).● You are entering the wrong remote access code. If you have forgotten your remote access code, enter the remote access code setting to check your current code (page 59).● The answering system is turned off. Turn it on (page 60).

Liquid damage

Problem	Cause/solution
Liquid or other form of moisture has entered the handset/base unit.	<ul style="list-style-type: none"> Disconnect the AC adaptor and telephone line cord from the base unit. Remove the batteries from the handset and leave to dry for at least 3 days. After the handset/base unit are completely dry, reconnect the AC adaptor and telephone line cord. Insert the batteries and charge fully before use. If the unit does not work properly, contact an authorised service centre.

Caution:

- To avoid permanent damage, do not use a microwave oven to speed up the drying process.

Registering a unit

Registering a handset to the base unit

The supplied handset and base unit are pre-registered. If for some reason the handset is not registered to the base unit (for example,  is displayed even when the handset is near the base unit), re-register the handset.

1 Handset:

[MENU] **#** **1** **3** **0**

2 Base unit:

Press and hold **[•••]** for about 5 seconds.

- If all registered handsets start ringing, press **[•••]** again to stop, then repeat this step. (KX-TGU432)

3 Handset:

[OK] → Wait until “Base PIN” is displayed. → Enter the base unit PIN (default: “0000”). → **[OK]**

- If you forget your PIN, contact an authorised service centre.

Deregistering a handset

A handset can cancel its own registration to the base unit, or other handsets registered to the same base unit. This allows the handset to end its wireless connection with the system.

- 1 **[MENU]#131**
 - All handsets registered to the base unit are displayed.
- 2 **[↕]**: Select the handset you want to cancel. → **[OK]**
- 3 **[↕]**: “Yes” → **[OK]** → **[🔌]**

Warranty (New Zealand)

Panasonic New Zealand undertakes to:

Repair or at its option, replace without cost to the owner, either for material or labour, any part which is found to be defective within two years of the date of purchase.

THIS EXPRESS WARRANTY DOES NOT COVER:

- 1) Pick up and delivery.
- 2) Batteries.
- 3) Repairs when the product has not been used in accordance with the Operating Instructions Manual or has been modified.
- 4) Normal maintenance and cleaning as required in the product's Operating Instructions Manual.
- 5) Service calls to:
 - a Correct the set up of the product
 - b Instruct you how to use the product
 - c Replace fuses or correct your building's wiring
- 6) Damage to the product caused by accident, misuse or Act of God.
- 7) Repairs when the product has been dismantled, repaired, modified or serviced by other than a Panasonic Authorised Dealer authorised to service that type of product.

IF YOUR PANASONIC PRODUCT FAILS WITHIN THE WARRANTY PERIOD:

Take it to the Authorised Panasonic Dealer from whom you purchased the product who will repair it (or arrange to have it repaired or replaced) during their normal business hours. All enquiries regarding warranty or otherwise, please call – Customer Support Centre Tel. No.: (09) 272 0178

NOTE: THIS EXPRESS WARRANTY IS OFFERED AS AN EXTRA BENEFIT AND DOES NOT AFFECT YOUR LEGAL RIGHTS.

Warranty (Australia)

Panasonic Warranty

Small Home Appliances 12 Month Warranty from Date of Purchase ("Warranty Period") Cordless Phones & Pet Care Products

- This warranty does not exclude, restrict or modify in any way other rights and remedies under the law which relates to the product, including any non-excludable statutory guarantees in Australia.
- Subject to the conditions of this warranty and during the Warranty Period, Panasonic or its Authorised Service Centre will perform the necessary service on the product without charge for parts or labour, if in the opinion of Panasonic, the product is found to be faulty within the Warranty Period.
- This warranty only applies to Panasonic products purchased in Australia and sold by Panasonic Australia or its Authorised Distributors or Dealers and only where the products are used and serviced within Australia or its territories. Warranty cover only applies to service carried out by a Panasonic Authorised Service Centre and only if valid proof of purchase is presented when warranty service is requested.
- This warranty only applies if the product has been used in accordance with the manufacturer's recommendations (as noted in the Operating Instructions) under normal use and reasonable care (in the opinion of Panasonic). The warranty covers normal domestic use only and does not cover damage, malfunction or failure resulting from:
 - misuse, abuse, neglect, accidental damage, or modifications.
 - infestation by insects or vermin.
 - incorrect installation, assembly, improper voltage, or mains supply problems.
 - natural disaster or acts of God (e.g., lightning, flood, fire, earthquakes etc).
 - rust or damage caused by exposure to abnormally corrosive conditions.
 - an accessory, component or other equipment not supplied by Panasonic Australia.
 - regular maintenance by the customer (refer to the maintenance section of the Operating Instructions) which includes but is not limited to the failure to undertake the following actions:
 - regular cleaning; and
 - where filters are included, regular cleaning and replacement of filters where necessary.
 - incorrect operation of the product; and
 - where no actual fault of the product is determined to have occurred, during a customer-initiated service call, and where the perceived problem is explained within the Operating Instructions (including the troubleshooting section) warranty service is not applicable.
- This warranty does not cover the following items unless the fault or defect existed at the time of purchase:
 - Casing Parts
 - User replaceable Batteries
 - Noise or vibration that is considered normal
 - Filters and bags
- Rechargeable batteries supplied with Cordless Phones are included in this warranty.
- You will be responsible for costs associated with making the warranty claim where there are costs associated with shipping or handling or travelling outside of the area normally serviced by Panasonic or any repair agent authorised by Panasonic.
- To the extent permitted by law and subject to your non-excludable statutory rights and guarantees, Panasonic excludes all warranties and liabilities (other than those contained in this warranty) including any liability for loss or damage whether direct or indirect arising from your purchase, use or non-use of the product.
- In addition to your rights under this warranty, Panasonic products come with consumer guarantees that cannot be excluded under the Australian Consumer Law. You are entitled to a replacement or refund for a major failure and compensation for any reasonably foreseeable loss or damage. You are also entitled to have the product repaired or replaced if the product fails to be of an acceptable quality and the failure does not amount to a major failure.
- To claim warranty service, when required, you should:
 - Contact Panasonic's Customer Care Centre on 132 600 for Authorised Service Centre information.
 - Send or take the product to a Panasonic Authorised Service Centre together with your purchase receipt as a proof of purchase date.

**THIS WARRANTY CARD AND THE PURCHASE DOCKET (OR SIMILAR PROOF OF PURCHASE)
SHOULD BE RETAINED BY THE CUSTOMER AT ALL TIMES**

If you require assistance regarding warranty conditions or any other enquiries, please visit the **Panasonic Australia** website www.panasonic.com.au or contact by phone on **132 600**.
If phoning in, please ensure you have your operating instructions available.

Panasonic Australia Pty. Limited

ACN 001 592 187 ABN 83 001 592 187

1 Innovation Road, Macquarie Park NSW 2113
www.panasonic.com.au

PRO-031-F49 Issue: 2.0

25.06.2024

Index

- A** Alarm: 45
 - Answering calls: 22
 - Answering system: 54
 - Call screening: 61
 - Erasing messages: 56, 57, 60
 - Greeting message: 55
 - Greeting only: 62
 - Listening to messages: 55, 56, 60
 - New message alerting: 57
 - Number of rings: 61
 - Recording time: 62
 - Remote access code: 59
 - Remote operation: 59
 - Turning on/off: 54
 - Area code: 53
 - Auto intercom: 26
 - Auto talk: 22, 42
 - Automated call block: 31
- B** Baby monitor: 47
 - Battery: 13, 14
- C** Call restriction: 49
 - Call share: 24
 - Call Waiting: 23
 - Call waiting and Caller ID compatible: 52
 - Call Waiting Caller ID: 23
 - Caller ID service: 51
 - Caller list: 52
 - Caller list edit: 53
 - Category: 34
 - Chain dial: 35
 - Character entry: 63
 - Conference calls: 25
 - Control type: 16
- D** Date and time: 18
 - Direct command code: 38
 - Display
 - Contrast: 42
 - Do not disturb mode: 46
- E** Eco mode: 19
 - Equalizer: 24
 - Error messages: 66
- F** Favourites Key: 36
 - First ring: 40
- H** Handset
 - Deregistration: 74
 - Name: 49
 - Registration: 73
 - Hold: 22
- I** Intercom: 25
- K** Key lock: 26
 - Keytones: 42
- L** Low battery alert: 19
- M** Making calls: 21
 - Missed calls: 51
 - Mute: 22
- N** Noise reduction: 24
 - Nuisance call block: 28
- P** Pause: 21
 - Phonebook: 34
 - PIN: 50
 - Power failure: 14
 - Power on/off: 18
 - Privacy mode: 42
- R** Recall/flash: 22
 - Redialling: 21
 - Region setting: 50

- Ringer indicator: 19
- Ringer tone
 - Intercom call: 40
 - Outside call: 40
- S** Security for phone calls: 50
- Speakerphone: 21
- Speed dial: 36
- T** Time adjustment: 41
- Torchlight: 19
- Transferring calls: 25
- Troubleshooting: 66
- V** Voicemail: 63
- Volume
 - Amplify key: 23
 - Receiver: 21
 - Ringer (Base unit): 22
 - Ringer for intercom call (Handset): 40
 - Ringer for outside call (Base Unit): 40
 - Ringer for outside call (Handset): 22, 40
 - Speaker: 21

For your future reference

We recommend keeping a record of the following information to assist with any repair under warranty.

Serial No.	Date of purchase
(found on the bottom of the base unit)	
Name and address of dealer	

For Australia

Customer Care Centre Tel. No.: 132600

or website www.panasonic.com/au

For New Zealand

Customer Care Centre Tel. No.: (09) 272 0178

or website www.panasonic.com/nz



Sales Department:

Panasonic Australia Pty. Limited

1 Innovation Road, Macquarie Park NSW 2113, Australia

Panasonic New Zealand Ltd.

18 Sir Woolf Fisher Drive, Highbrook, East Tamaki, Auckland,
New Zealand

Phone: (09) 272 0100

Panasonic Entertainment & Communication Co., Ltd.

1-10-12 Yagumo-higashi-machi, Moriguchi City, Osaka 570-0021, Japan
<http://www.panasonic.com>

© Panasonic Entertainment & Communication Co., Ltd. 2024

PNQP1950ZA PP0724MH0