



Panasonic®

Operating Instructions

Refrigerator (For Household Use)

Model No. NR-CY55C

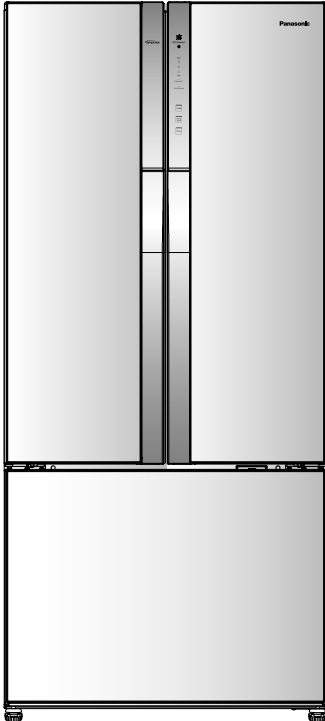

Contents

Introduction	
Safety Precautions.....	2
Installation	
Installation.....	8
Operation	
Parts Identification	10
To use all features.....	11
- Control Panel	11
- ECONAVI Operation.....	13
- Prime Fresh +.....	13
- Quick Freezing	14
- Food Stored	15
- Using Tips.....	16
- Refrigerator Compartment	17
- Prime Fresh.....	17
- Freezer Compartment.....	18
Appendix	
Cleaning, removing and re-installing.....	19
Troubleshooting	22
Specifications.....	24

Thank you for purchasing this Panasonic product.

- Before operating this unit, please read these instructions completely.
Before using this product, please pay particular attention to the “Safety precautions” section (Pages 2 to 7) for safe use.
- Please ensure the date and name of store of purchase are stamped in warranty card and keep it stored together with these operating instructions in a safe place for future reference.

Safety Precautions



WARNING

This expression presumes possibility of a death or serious injury.



CAUTION

This expression presumes possibility of personal injury or property damage.



This sign means prohibited action



This sign means required actions



This sign means do not disassemble



iso-butane

Risk of fire / flammable materials



WARNING

For power plug and cord...



- Periodically wipe the power plug with a dry cloth. (Dust accumulated on the plug of a refrigerator that operates continuously leads to reduced insulation due to moisture and may cause fire.)
- Plug into a wall outlet of the rated voltage on its own with the rated current and insert plug fully.
- Connect to an exclusive wall outlet for the refrigerator only. Avoid connecting other appliances to the same wall outlet. Unroll entire length of the cord before plugging in.
- Unplug the unit when cleaning the refrigerator.
- If the supply cord is damaged, it must be replaced by the manufacturer, its service agent or similarly qualified persons in order to avoid a hazard.
- Please ensure minimum clearance of 10 cm for air ventilation and prevent damage to the power cord.

For power plug and cord...

- Do not let the cord get damaged.
- Do not insert or disconnect the power plug into/from the wall socket with wet hands.
- When positioning the appliance, ensure the supply cord is not trapped or damaged.
- Do not locate multiple portable socket-outlets or portable power supplies at the rear of the appliance.

When recycling the product...

- Before taking the refrigerator to be recycled, please remove all the door gasket to prevent locking a child in it.
- The operating instructions should be handed over to any person who would use or handle the refrigerator whenever the refrigerator would be transferred to another location and delivered to a recycling plant.
- Cyclo-Pentane is used for insulation of this refrigerator and flammable gas is used for refrigerant. When disposing of this unit, please discard it by the proper method and do not dispose of the unit by burning.
- The warning labels mentioned above should be kept throughout the life of the refrigerator.

In order to prevent fires,
electrical shocks, explosion,
injuries, etc.

**In case of emergency...**

R600a
iso-butane

- Maintenance work must only be carried out at workshop by well-trained maintenance worker.



- Do not store explosive substances such as aerosol cans with a flammable propellant and chemicals or scientific specimens in the appliance.

Safety Precautions



WARNING



- Do not use electrical appliances such as a deodorizer in the refrigerator. Leaked refrigerant may catch fire from a spark of the electrical contacts and may cause an explosion.
- Do not use electrical appliances inside the food storage compartments of the appliance, unless they are of the type recommended by the manufacturer.

- Do not use mechanical devices or other means to accelerate the defrosting process, other than those recommended by the manufacturer.



- Do not disassemble, repair or modify the refrigerator by yourself. If you want to repair the refrigerator, please consult your dealer or authorized service center.

On top of the refrigerator...



- Do not put anything on top of refrigerator. Otherwise, it may fall due to vibration of the machine. You may be injured.

When installing...



- Do not install the product in locations exposed to water.
- Provide a grounding connection or install a ground-fault interrupter when the product is installed in a humid or wet location.
(Contact your distributor.)
- Do not block the ventilation port of the refrigerator or spaces around it.
Leaked refrigerant may cause a fire and explosion.
- Keep ventilation openings, in the appliance enclosure or in the built-in structure, clear of obstruction.



- For safety it should be checked that the ground connection system in the house has been installed correctly.

When using...

- Do not let any children hang or ride on the refrigerator door, the unit may turn over and cause an accident.
- Do not apply water on the body or interior. Electrical insulation could deteriorate and may cause shocks or fire.
- Do not damage the refrigerant circuit (piping on the back). The flammable refrigerant may catch fire and lead to an explosion.
- Do not touch the compressor or pipes because of high temperature. There is a risk of burn injury.
- Do not spray combustible chemicals near the refrigerator.



- If you detect a burning smell, disconnect the power plug.
- If you detect a gas leak from the cooling range, ventilate the kitchen.
- If you have damaged the refrigerant circuit (piping on the back), then ventilate the kitchen and contact your distributor.
- Refrigerator LED lamp.

The refrigerator LED lamp is designed specially for this product, it does not function on individual replacing. If replacement is required, please contact your dealer or authorised service agent.



- This appliance is not intended for use by persons (including children) with reduced physical, sensory or mental capabilities, or lack of experience and knowledge, unless they have been given supervision or instruction concerning use of the appliance by a person responsible for their safety.
- Children should be supervised to ensure that they do not play with the appliance.

Safety Precautions



CAUTION

When storing food...



- Do not freeze glass bottles, that there is a risk of injury. (If the liquid in a glass bottle is frozen and broken, you may be injured.)
- Do not touch frozen foods or containers (especially metallic) with wet hands.
- Do not eat any smelling or colour-changed food. Rotten food may cause illness.
- Do not subject glass trays to high impact. (Otherwise those glass trays may break and you may be injured)



- Food containers must reach the bottom of the door shelves.
- The foods must not protrude from the shelf.

When opening/closing the doors...



- Do not open the refrigerator doors when someone is in the vicinity of the refrigerator.
- Mind the gap between the doors. They may nip your hand while closing the door.
- Do not push drawers by holding them at the top.
- Be careful not to place your feet under the bottom drawer.

When cleaning...



- Do not place your hands or feet beneath the bottom of the refrigerator.
- Do not slide hands on the metal rail.
- Be cautious of hot copper pipe inside pan water evap when removing it.
- Do not clean the refrigerator with chemical substance or liquid. It will cause damage and have corrosion on the surface.

When moving or transporting the refrigerator...

- Do not transport the refrigerator in a horizontal position. Laying the refrigerator horizontally may damage the piping. If any damage is noticed, do not touch the refrigerator. Avoid using fire and ventilate the room and contact the service agent immediately.



- Apply protective covering, etc. to floors with a fragile surface.
- Hold the carrying handles when transporting the refrigerator.

**Caution for using****When using...**

- Do not place warm/hot foodstuffs in the refrigerator. Store warm food and drinks after they have cooled.
- Do not open refrigerator frequently or leave it open for long time in order to prevent water dripping inside and waste energy.

When the refrigerator will not be used for a long period of time...

- Unplug the refrigerator and take out all the food in the refrigerator.
- Wipe off all the water and open the refrigerator to keep it dry.

This appliance is intended to be used in household and similar applications such as

- staff kitchen areas in shops, offices and other working environments;
- farm houses and by clients in hotels, motels and other residential type environments;
- bed and breakfast type environments;
- catering and similar non-retail applications.

Installation

Before using for product.

Is the refrigerator installed in the following locations?

- Locations subject to heat and direct sunlight (The cooling power will be reduced and electricity wasted.)
- Poorly ventilated locations with high humidity (Rust will be caused.)
- Locations where the surface is unstable and slanted
→ On carpet, mats, or vinyl floors, place a plate underneath the refrigerator.
- Locations not allowing the power plug to be cleaned easily (Dust accumulated may cause a fire.)

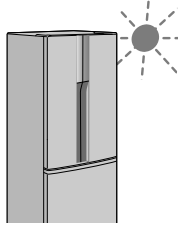

Has a heat radiating space been provided around the refrigerator?

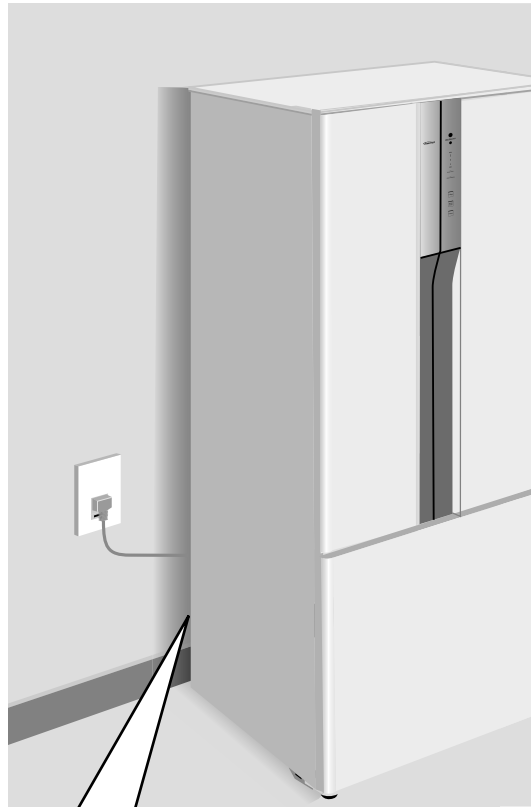
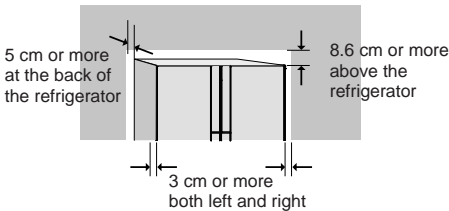

For safety, the grounding connection should be done

(For a refrigerator with plug (2-pin plug) without any grounding wire)

The grounding connection will allow prevention of danger resulted from electricity leakage. The grounding connection can be performed in 2 ways as follows:

- In the case that the grounding receptacle has been prepared for the socket (plug socket), connect the grounding wire to the screw used for grounding connection at the bottom rear of the refrigerator (regarding the screw used for grounding connection, please notice the ⚡ symbol) as shown in the illustration ①.
- In the case that the socket (plug socket) has not been provided with any grounding receptacle, connect the grounding wire to the screw at the bottom of the refrigerator, (as regard to the screw used for grounding connection, please notice the ⚡ symbol). And then connect the other end to the grounding rod as shown in the illustration ②.

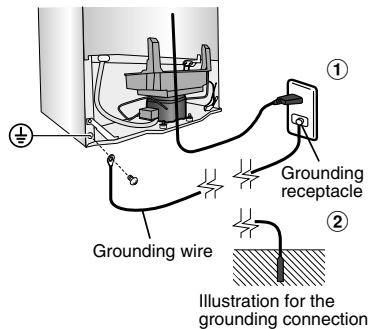

Prohibited spots for grounding connection

- Water supply pipes and gas pipes (dangers from electric shock or explosion).
- The grounding wires of telephone cords and lightning rods (dangers from lightning).

Requests and notices



Do not peel the seal on the back.

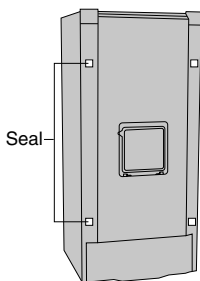

Otherwise, the cooling performance may deteriorate. If you have peeled it, then cut a cloth packing tape into a square and paste it onto the refrigerator.

Refrigerator doors should not be opened during the interior cooling process.

The doors should not be opened until the interior has been cooled down sufficiently. (Warm air flowing into the interior will block the cooling function.)

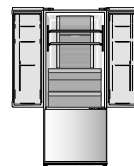

Please wait until the interior has cooled down.

- It may take approximately four hours to cool down the interior.
- It may take 24 hours or more to cool down the interior and achieve equilibrium in the summer, etc.

Fix the refrigerator.

Turn the adjuster bolts (right and left) until they reach the floor to stabilize the refrigerator.

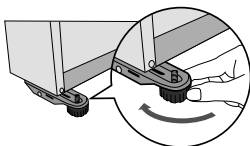

Have any measures taken against tipping due to earthquakes?

In order to prevent the refrigerator from tipping, permanently fix it by using belts, etc.

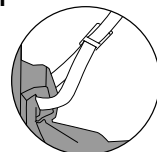

If the door is slanted downwards.

Turn the adjuster bolt on the lower side, as shown in the diagram, in order to adjust the level.

- The freezer/refrigerator doors may tilt within four to five days after installation due to the load of the food or adaptation to the floor surface, turn the corresponding adjuster bolt with the dedicated tool to adjust and level the door again to restore.

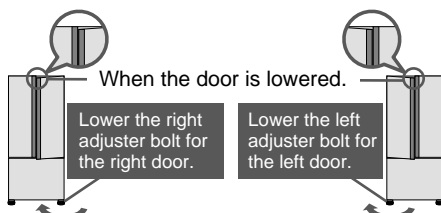

- Dedicated tool (Accessories)

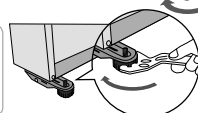

Parts Identification

Ⓐ REFRIGERATOR COMPARTMENT

Ⓑ FREEZER COMPARTMENT

Ⓒ PRIME FRESH CASE
(with Blue AG lamp LED NR-CY55C (GKAU))

- 1 LED lamp
- 2 Small tempered glass tray
- 3 Large tempered glass tray
- 4 Tempered glass tray crisper
- 5 Vegetable case
- 6 Ice twister
- 7 Ice box
- 8 Bottom freezer case
- 9 Egg shelf
- 10 Egg tray
- 11 Free rack PC
- 12 Door gasket
- 13 Bottle shelf
- 14 Freezing case
- 15 Adjuster bolt
- 16 Evap pan
- 17 Compressor

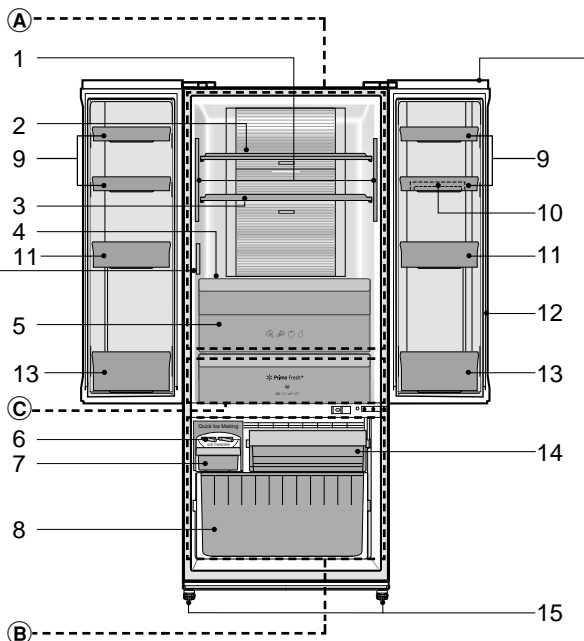

Control panel **NR-CY55C (PSAU)** (P.11)

Control panel **NR-CY55C (GKAU)** (P.11)

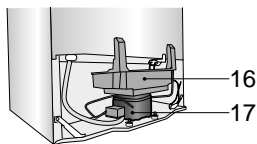

Product view from behind

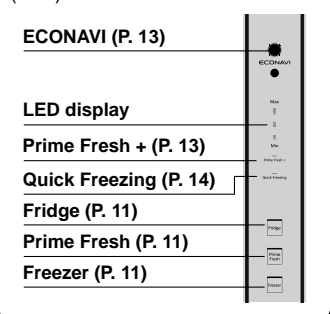
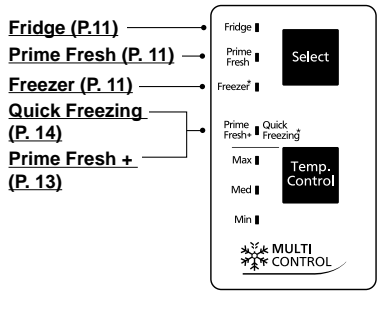

■ SPECIAL FEATURE

●NON-FLON

This unit uses totally NON-FLON MATERIALS both for refrigerant (iso-butane (R600a)) and for insulation (Cyclo-Pentane). These materials do not damage the earth's ozone layer and has almost no effect on global warming.

●INVERTER

In accordance with temperature change inside the compartment, the motor will run at different speeds. When the temperature inside the refrigerator is stable, the motor will run at a lower speed to save energy and lower noise.

When powerful cooling is required, the motor will run at a higher speed.

To use all features

Control Panel

■ Temperature setting and a guide of temperature

Model : NR-CY55C (GKAU)

The temperature can be adjusted for Min-Max levels.

Touch [Fridge] button to adjust temperature in refrigerator compartment and touch [Freezer] button to adjust temperature in freezer compartment.

The setting of [Prime Fresh] can be set to either “Prime Fresh +”, “Min”, “Med” or “Max” levels.

Model : NR-CY55C (PSAU)

① Press the [Select] button to select Refrigerator Compartment [Fridge], Prime Fresh Case [Prime Fresh], or Freezer Compartment [Freezer].

② Press the [Temp. Control] button to select from Max, Mid, or Min levels.

Temperature setting \ Button	Fridge	Prime Fresh	Freezer
Max	Lower than “Med” by approx. 2 °C ~ 3 °C	Lower than “Med” by approx. 2 °C ~ 3 °C	Lower than “Med” by approx. 2 °C ~ 3 °C
Med	Approximately 1 °C ~ 6 °C	Approximately -5 °C ~ -1 °C	Approximately -23 °C ~ -17 °C
Min	Higher than “Med” by approx. 2 °C ~ 3 °C	Higher than “Med” by approx. 2 °C ~ 3 °C	Higher than “Med” by approx. 2 °C ~ 3 °C

Generally, use the refrigerator with the temperature set to “Med”.

(If the temperature control of the freezer compartment or refrigerator compartment is set to other than “Med”, ECONAVI does not operate.)

■ How to operate the “9 levels” mode

This refrigerator is specially designed with 9 adjustable temperature levels.

To adjust the temperature for the Refrigerator Compartment

Model : NR-CY55C (GKAU)

① Set the LED display to the “Min” position by touching the [Fridge] button.

② Touch and hold the [Fridge] button for 10 seconds until the LED display return to show at the “Min” position.

③ Use the [Fridge] button to set the required temperature mode, where one step is the minimum cooling mode and 9 step is the maximum cooling mode.

To adjust the temperature for the Freezer Compartment

Follow steps ① ~ ③ above, but select freezer compartment [Freezer] instead of refrigerator compartment [Fridge].

To use all features

Model : NR-CY55C (PSAU)

- ① Set the LED display to “Min” position by pressing the [Select] button to select [Fridge] (refrigerator compartment) then press the [Temp. Control] button to select Min.
- ② Press and hold the [Temp. Control] button for approximately 10 seconds until the LED display returns to the “Min” position.
- ③ The temperature can be adjusted in 9 different levels as specified in the cooling level table below. By pressing the [Temp. Control] button, the cooling level increases by an increment of 1 level.

To adjust the temperature for the Freezer Compartment

Follow steps ① ~ ③ above respectively while pressing the [Select] button and selecting [Freezer] (freezer compartment) instead of [Fridge] (refrigerator compartment).

To reset the setting “9 levels” mode

Repeat steps ① and ② to return the unit to normal operation mode.

●LED Display table (Model : NR-CY55C (GKAU))

Step	Cooling Level								
	Minimum			→			Maximum		
LED Display	1	2	3	4	5	6	7	8	9
	■ Lighting			⚡ Blinking			■ Not lighting		

●LED Display table (Model : NR-CY55C (PSAU))

Step	Cooling Level								
	Minimum			→			Maximum		
LED Display	1	2	3	4	5	6	7	8	9
	Max Med Min	Max Med Min	Max Med Min	Max Med Min	Max Med Min	Max Med Min	Max Med Min	Max Med Min	Max Med Min
	■ Lighting			⚡ Blinking			■ Not lighting		

- The temperature control can vary depending on the environment and amount of food stored in the refrigerator.

ECONAVI Operation

Model : NR-CY55C (GKAU)

The refrigerator detects the opening and closing of the refrigerator door and the brightness around the refrigerator to automatically control operation to ensure maximum energy saving.*1

■ ECONAVI operation

- The refrigerator learns the lifestyle patterns of your family from door opening and time periods of infrequent use to maximise energy efficiency.
- The refrigerator learns your lifestyle patterns from the previous 3 weeks of use and uses that data from the 4th week onwards.
Therefore the ECONAVI lamp "ON/OFF" pattern may change from the 4th week onwards.
- The refrigerator performs the ECONAVI energy saving operation when it becomes dark*2 around the refrigerator such as overnight when you are asleep.
- The brightness of the ECONAVI lamp is lowered approximately 5 minutes after it is lit.

■ Settings for enabling ECONAVI operation

- ECONAVI operation is automatically enabled when the temperature control for both the freezer and refrigerator compartment is set to "Med".
- ECONAVI mode does not operate if the [Quick Freezing] mode is in operation.
- It is not possible to force to start of the ECONAVI mode.

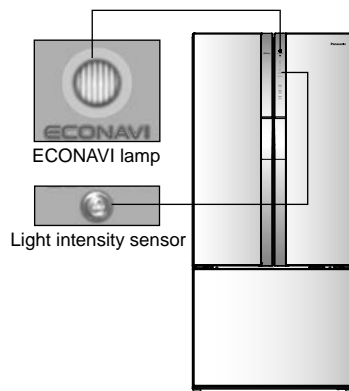

Remark

*1 The effectiveness of the ECONAVI mode is dependant on the ambient temperature, ambient brightness and the number of times the refrigerator door is opened and closed and the state in which food is stored.

*2 Darkness is detected by the light intensity sensor at approximately 3 lx to 10 lx or less.

Model : NR-CY55C (PSAU)

This model also has ECONAVI mode, but it does not feature ECONAVI lamp and light intensity sensor.

Prime Fresh +

■ How to operate the "Prime Fresh +" mode

① **Model :** NR-CY55C (GKAU)

Press the button "Prime Fresh" until the light LED "Prime Fresh +" turns on.

② **Model :** NR-CY55C (PSAU)

Press the button "Select" until the light "Prime Fresh" turns on, then press button "Temp. Control" until the light LED "Prime Fresh +" turns on.

Remark

- If you want to stop the operation immediately, please repeat step ① or step ② until the light LED turns off.
- The system will stop the operation automatically when it runs for 105 mins (as ambient temperature is below 18 °C) or 150 mins (as ambient temperature is above 18 °C) and return to normal mode (the LED turns off)
- The LED flashing means that the defrosting system is now working. "Prime Fresh +" mode will start right after the defrosting operation is finished.

To use all features

Quick Freezing

■ When [Quick Freezing] is set, the refrigerator will reduce the temperature quickly for better performance of preserving food.

Model : NR-CY55C (GKAU)

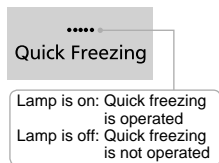

- Touch the [Freezer] button until “Blue LED light at Quick Freezing” turns on. (Quick Freezing mode starts after 10 seconds.)
- The Quick Freezing operation will automatically stop after 60 mins (as ambient temperature is below 19 °C) or 150 mins (as ambient temperature is above 19 °C) and return to normal mode. (The Blue LED light at Quick Freezing turn off)

- To stop the Quick Freezing operation, touch the [Freezer] button until “Blue LED light at Quick Freezing” turns off.
- A flashing “Blue LED light at Quick Freezing” indicates the defrosting system is active. The Quick Freezing operation will start right after the defrosting operation is finished.
- The Freezer temperature control will not operate during Quick Freezing mode as the compressor is already at maximum operating levels for the Quick Freezing mode.

Model : NR-CY55C (PSAU)

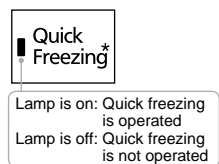

- Press the [Select] button and selecting [Freezer] then press [Temp. Control] button until “Green LED light at Quick Freezing” turns on. (Quick Freezing mode starts after 10 seconds.)
- The Quick Freezing operation will automatically stop after 60 mins (as ambient temperature is below 19 °C) or 150 mins (as ambient temperature is above 19 °C) and return to normal mode. (The Green LED light at Quick Freezing turn off)

- To stop the Quick Freezing operation, press the [Temp. Control] button until “Green LED light at Quick Freezing” turns off.
- A flashing “Green LED light at Quick Freezing” indicates the defrosting system is active. The Quick Freezing operation will start right after the defrosting operation is finished.
- The Freezer temperature control will not operate during Quick Freezing mode as the compressor is already at maximum operating levels for the Quick Freezing mode.

Food Stored

■ In order to preserve food quality for long time, please store it in the right place.

When storing food...

- Foodstuff such as vegetable, fruits and fresh food should be wrapped or pack in box before freezing and refrigerating.
- If you will put high moisture content into refrigerator, should be sealed and wrapped to prevent dew and frost.
- Drinking water, beverage bottles should be sealed to prevent the odour.
- Store fruits and vegetables in vegetable case, where trapped moisture helps preserve food quality for longer time periods.

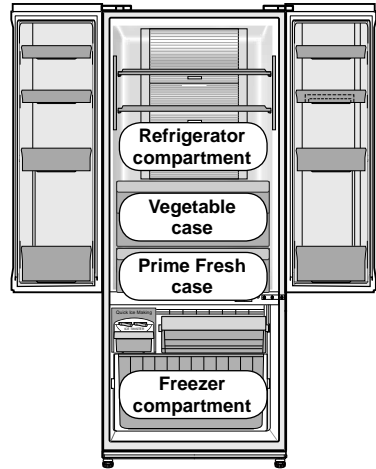

Where to store these different foodstuffs?

Approx.

1°C~6°C

Refrigerator compartment

“Food and drinks readily served”

For regular storage of food and drinks or temporary storage of these to be served soon.



Approx.

3°C~8°C

Vegetable case

“Fruits and vegetables”

A rather high humidity keep fruits and vegetables fresh and juicy.

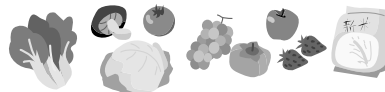

Approx.

-5°C~-1°C

Prime Fresh case

“Partially-freezing”

For storage of meat, fish, processed foods (such as hams and sausages).



Approx.

-23°C~-17°C

Freezer compartment

“If storing food for an extended period”

For storage of frozen or dried foods.



- When set to “Med”, the temperature may vary slightly depending on the usage conditions.

To use all features

Using Tips



Basics of energy saving
Save cool air!

Do not stuff food into the compartments.

That may interfere with the cold air flow. Provide sufficient space between foods.

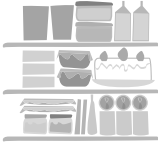

Store warm food and drinks after they have cooled.

Otherwise, they will not only raise the interior temperature, but also affect the freshness of other foods.



Do not block the cold air outlet with food items!

If cool air does not spread into every corner of compartments, then the interior (Air outlet) will not be sufficiently cooled and more electricity will be consumed.

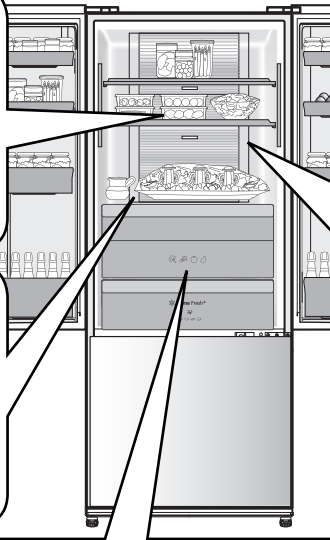
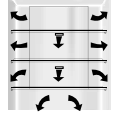

When condensation occurs.

■ The humidity in the vegetable case is high and condensation may occur. Just wipe off the water drops.

Do not put food in the refrigerator when it is not necessary.

■ A cold dark place will suffice!

■ Cool just before you eat!



It is not necessary to store uncut onions, potatoes, etc. in the refrigerator (except during the summer).



If uncut tropical fruits are cooled down excessively, they may be discolored or their vitamin contents may decrease.

Storage using tightly sealed containers is recommended!



● Cut citrus fruits
(→The plastic will be discolored white.)



● Garlicky or other strong smelling vegetables
(→ Odors will spread to other nearby food.)

Refrigerator Compartment

The position of the second tray from the top can be changed

(1) Lift up the back of the tray and pull it forward. Once the protrusions of the tray are unhooked from rails, tilt the tray and remove it.

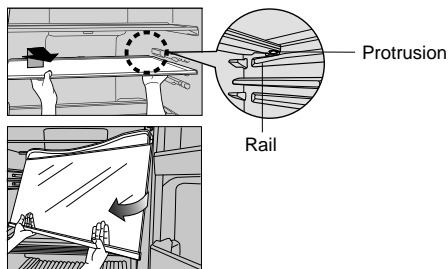

(2) Insert the tray in the desired position by reversing the steps.

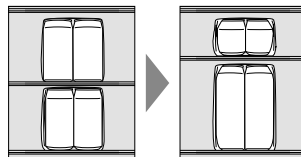

- Glass shelves are heavy. Please handle them with care so that they do not fall and cause any damage or injury.

Close the open door

- There are beeps sound if the refrigerator compartment or the freezer compartment door is remained open as below table.

Please close the door.

(Model : NR-CY55C (GKAU))

Time	Alarm
1 minute later	Double-beep
3 minutes later	2 double-beep
5 minutes later	Continuous double-beep

Request

- When the rotary partition is opened forward, put it back into place. (The doors can not be closed and it may cause damage.)



Prime Fresh

The temperature in the Prime Fresh Case can be selected from "Prime Fresh +", "Min", "Med", or "Max".

When using the refrigerator, temperature can be adjusted according to your personal usage.

*The temperature is set at "Med" as default from factory.

Using as the prime fresh

Approx. -5 °C ~ -1 °C

- When you want to preserve food longer by partially-freezing method.

- Suitable for fresh food such as meat or fish.
 - Temperature can be selected from "Prime Fresh +", "Min", "Med", or "Max" according to kind and quantity of stored food. (P. 11)
- When food is too much frozen
Set the temperature at "Min" (less cool) to reduce coldness and prevent food from over frozen.
- When food is not partially-frozen
It could result from size of stored food (such as too large meat or fish), storage condition, or ambient temperature. Try setting the temperature at "Max" (more cool) to increase coldness and partially-frozen the food.



To use all features

Freezer Compartment

Approx. $-23\text{ }^{\circ}\text{C}$ ~ $-17\text{ }^{\circ}\text{C}$

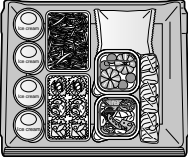

Freezing case (Upper)

- A lot of frozen food and cooked meal can be stored.

Requests

- For the upper case of the freezer, put your food within the height of the case.
- For the lower case of the freezer, put your food below the upper limit line inside the case.
(Otherwise, the door may not close completely and frost may occur.)

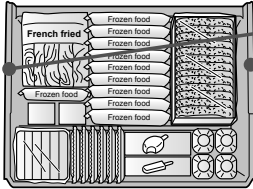

Bottom freezer case (Lower)
[This is a storage example]



Three tips for freezing food and locking in the flavour...

1. Freeze thin and small items of food quickly!
2. Fully sealed
3. Do not refreeze

To make ice

1 Take out the ice twister

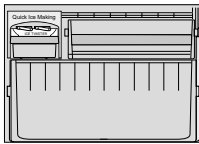

Pull out the ice twister. (P.21)

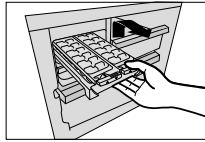

2 Fill with water

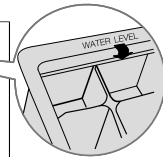
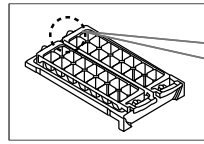

Fill water up to the "WATER LEVEL" line.

3 Install the ice twister



Place tray back into the ice making compartment.

4 To move ice cubes



Twist the ice twister clockwise.
(The ice cubes will drop into the ice box.)

Cleaning, removing and re-installing

Before cleaning or conducting maintenance, be absolutely sure to disconnect the power plug from the power outlet. Do not connect or disconnect the power plug with wet hands. When the plug is disconnected, leave it for 10 minutes before plugging again. If not, the compressor may not work.

Cleaning

Clean the refrigerator immediately after it is stained!

Wipe off stains on the interior surfaces quickly before they harden. In particular, cooking oil may cause plastic to crack and citrus juice may cause the refrigerator to become discolored. When stains cannot be removed easily, wipe them with a cloth lightly soaked in neutral kitchen detergent. Then, wipe with a cloth lightly dipped in water.



Clean the detachable items occasionally...

Once a week for the ice twister. As a guide, remove the trays, door shelves, etc. and wash them by immersing them in lukewarm water every three months.



Clean the door gasket at least once a month.

Clean by wiping with a soft damp cloth. Petroleum gel has been applied to the door gasket on the hinge side of the unit, be careful not to wipe this off.

Rub the door surface with a soft damp cloth.

Rub the control panels with a dry cloth.

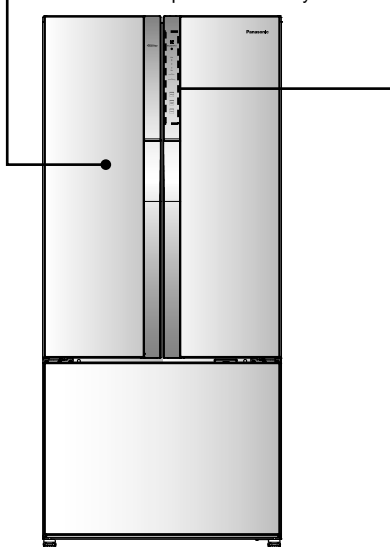

Point where petroleum gel was applied.

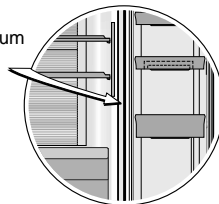

Notices

The "door gasket" is replaceable by an authorised service agent. If the door gasket comes off while cleaning, it can be pushed back into the groove.

Requests

Do not use the following items for cleaning. (Otherwise, the surface will be scratched.)



Kitchen detergents
(They crack plastic!)

Alkaline or faintly
Alkaline



Cleanser or soap powder



Benzene, thinner, alcohol,
acid, petroleum



Scrubber



Hot Water

Cleaning, removing and re-installing

Trays

Once every 3 months

■ Removing

- ① Lift up the back of the tray and pull it forward. Once the protrusions of the tray are unhooked from the rails, tilt the tray and remove it.

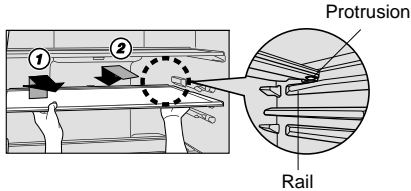

■ Attaching

- ② Push the tray until it reached the end lock.



Attention

- When removing the tray above the vegetable case, please pull out the vegetable case first and then follow to removing the tray as above details.
- In case of attaching the tray and it does not lock, make sure that you did not attach it the wrong tray.
- Trays are made of glass and heavy. Please handle them with care so that they do not fall and cause any damage or injury. For attaching trays, hold them with the protrusion side down and firmly insert.

Door shelf/Bottle shelf

Once every 3 months

■ Removing

Tap the bottom of the small shelves upward or slide alternately the left and right of the big shelves upward, and raise them slowly. (Tightly attached)



■ Attaching

Set each shelf horizontally, with the mark [>PS<] on the right, and push it down to its proper position.

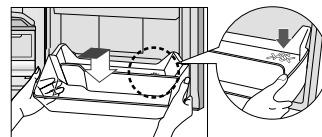

Vegetable case/Prime fresh case

Once every 3 months

■ Removing

- ① Pull the case unit forward until it reaches the end of the stopper.
- ② Lift the front of the case unit slightly and remove completely.



■ Attaching

- ① Insert the case unit into the supports.
- ② Raise the case unit up slightly and push forward until the end is reached.

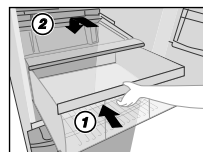

Bottom freezer case (Freezer compartment)

- ① Pull the freezer draw out towards yourself.
- ② Lift up the drawer slightly and pull towards yourself until it reaches the stoppers.
- ③ Lift both sides of the bottom freezer case and move upward.

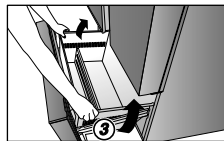
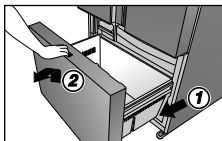
**Attention**

- The contact sections of the drawer rails have been coated with lubricant. Do not wipe it off. (The lubricant complies with the Food Sanitation Law.)

ICE TWISTER (Quick Ice Making corner)**Once every 3 months****Removing**

- ① Unhook the protrusion by lifting it upward and pulling the ice twister and ice box forward until completely removed.

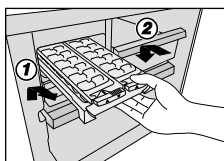

ICE TWISTER

Attaching

- ② Push the ice twister and ice box until it reaches the end lock.



ICE BOX

Attention

- You can disassemble the ice twister and ice box to increase space in the freezer.

Evap pan (Backside of the refrigerator)**Once every 3 months****Removing**

- ① Tilt up the evap pan a bit and then lift it upward until the evap pan hole unlocks from the hook evap pan.
- ② Pull the evap pan until it touches with the evap pipe then carefully take it out under the evap pipe.

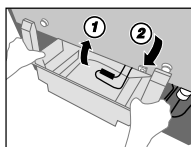
**Attaching**

- ① Insert the evap pan under the evap pipe.
- ② Insert the evap pan hole into the hook evap pan as well as press-fitting both sides.

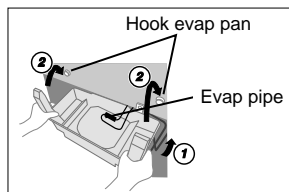
**Request**

- Do not damage or deform the evap pipe.

Troubleshooting

In these cases?	Check here.
The refrigerator does not operate.	<ul style="list-style-type: none"> ● Check that the plug and wall socket are in good condition. ● Check if there is any problem with the mains fuse or house wiring. ● Check by unplugging for 10 minutes and plugging back in.
The refrigerator does not cool enough.	<ul style="list-style-type: none"> ● Check to be sure that light in control panel is display at proper position (P.11, P12) ● Check to ensure that the refrigerator is not overloaded with foodstuffs or that hot food have been placed in the refrigerator. ● Is the refrigerator exposed to direct sunlight or a heat source? ● Is the refrigerator door completely closed? ● Is the refrigerator door opened frequently?
Vapor generated inside and outside the cabinet / surface of door.	<ul style="list-style-type: none"> ● Condensation may appear on the surface of the cabinet when humidity is high or air circulation around the unit is poor. ● If there is condensation inside, check if the door is completely closed. ● Is the refrigerator frequently opened or left open for a long time? ● Have any hot foodstuffs been placed inside the refrigerator?
The refrigerator generates noise.	<ul style="list-style-type: none"> ● Check if the refrigerator is located on a stable, level floor and is installed correctly. Use the adjustable bolt if required to level the refrigerator. (P.9) ● Check if there is any object in contact with the refrigerator. ● Cracking sound within caused by the parts adjusting temperature which is normal. ● After installation, the refrigerator may make loud noise. The noise will be less when the refrigerator has been cooled.
Food becomes frozen	<ul style="list-style-type: none"> ● Was the food placed near the cold air duct? ● If the temperature control has been set to "Max" try adjusting the temperature control to the "Min" setting. ● Has the food been placed in the prime fresh case?

In these cases?		Check here.
The ECONAVI lamp does not light properly. (Model : NR-CY55C (GKAU))	ECONAVI does not operate. (the ECONAVI lamp does not light)	<ul style="list-style-type: none"> ●Has the “Quick Freezing” mode been activated? (P.14) ●Is the temperature setting of the freezer compartment set to something other than “Med”? ●Has the door been opened frequently or has hot food been placed in the refrigerator? ●The learning function may automatically disable ECONAVI operation during times of frequent use.
	ECONAVI operation is rarely performed.	<ul style="list-style-type: none"> ●Is there a power failure? If a power failure occurs, the learning function data collected up until the point of power failure will be lost. The ECONAVI operation will rarely be performed until the learning function has collected data again.
	ECONAVI operation is stopped part way though.	<ul style="list-style-type: none"> ●If the auto defrost function is turned on during ECONAVI operation, the normal cooling operation will need to be performed after defrost. Therefore the ECONAVI operation may be stopped during this defrost/cooling process. ●The learning function may sometimes restart the normal cooling operation.
	ECONAVI operation is performed too often (the ECONAVI lamp rarely turns off).	<ul style="list-style-type: none"> ●Is the light intensity sensor hidden? ●Are there dirt or scratches on the control panel where the light intensity sensor is located? ●ECONAVI operation may be performed while the refrigerator is being used depending on the conditions of use, but the cooling performance is maintained.

Specifications

Model No.		NR-CY55C	
		GKAU	PSAU
Freezer Star Rating		* ** *	
Capacity (L) Gross/Storage (AS/NZS 4474)	Total	551 / 494	551 / 494
	Freezer	157 / 134	157 / 134
	Refrigerator	393 / 360	393 / 360
Outside Dimensions Width x Depth x Height (mm)		770 x 743 x 1714	
Refrigerant Type		R600a	
Net Weight (kg/lb)		89 / 196	82 / 180
Blue AG		Yes	No
Cooling System		Non-frost cooling.	
Rated Voltage (V) Rated Frequency (Hz)		Refer to the rating label attached at the door or the back of the cabinet.	

Panasonic Corporation

<http://www.panasonic.com>

© Panasonic Appliances (Thailand) Co., Ltd. 2019