

Panasonic®

Operating Instructions Rechargeable Professional Hair Clipper Model No. ER-GP21

Contents

Safety precautions	2	Care	8
Important information	6	Troubleshooting	10
Parts identification	6	Removing the built-in rechargeable battery	11
Charging the clipper	7	Specifications	11
Using the clipper	8		

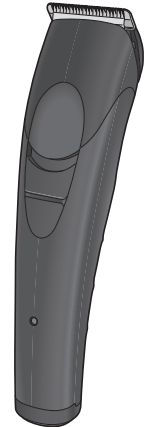

Thank you for purchasing this Panasonic product.

Before operating this unit, please read these instructions completely and save them for future use.

Safety precautions

To reduce the risk of injury, loss of life, electric shock, fire, and damage to property, always observe the following safety precautions.

Explanation of symbols

The following symbols are used to classify and describe the level of hazard, injury, and property damage caused when the denotation is disregarded and improper use is performed.



DANGER

Denotes a potential hazard that will result in serious injury or death.



WARNING

Denotes a potential hazard that could result in serious injury or death.



CAUTION

Denotes a hazard that could result in minor injury or property damage.

The following symbols are used to classify and describe the type of instructions to be observed.



This symbol is used to alert users to a specific operating procedure that must not be performed.



This symbol is used to alert users to a specific operating procedure that must be followed in order to operate the unit safely.



WARNING

► Power supply



Do not connect or disconnect the power plug to a household outlet with a wet hand.

-Doing so may cause electric shock or injury.

Do not immerse the appliance and AC adaptor in water or wash it with water.

Do not place the appliance and AC adaptor over or near water filled sink or bathtub.

Never use the appliance if the AC adaptor is damaged or if the power plug fits loosely in a household outlet.



Do not damage the cord or power plug.

• **Do not deface, modify, forcefully bend or pull the cord or the power plug. Also, do not place anything heavy on, twist or pinch the cord.**

-Doing so may cause burn, electric shock or fire due to a short circuit.

Keep the appliance dry.



WARNING

Do not use in a way exceeding the rating of the household outlet or the wiring.



- Exceeding the rating by connecting too many plugs to one household outlet may cause fire due to overheating.

Do not use anything other than the supplied AC adaptor for any purpose. Also, do not use any other product with the supplied AC adaptor. (See page 6.)



- Doing so may cause burn or fire due to short circuit.

Always ensure the appliance is operated on an electric power source matched to the rated voltage indicated on the AC adaptor. Fully insert the power plug.



- Failure to do so may cause fire or electric shock.

Always unplug the power plug from a household outlet when cleaning.



- Failure to do so may cause electric shock or injury.

Regularly clean the power plug and the charging plug to prevent dust from accumulating.



- Failure to do so may cause fire due to insulation failure caused by humidity.

Disconnect the power plug and wipe with a dry cloth.

► In case of an abnormality or malfunction

Immediately stop using and remove the power plug if there is an abnormality or malfunction.

- Failure to do so may cause fire, electric shock, or injury.

<Abnormality or malfunction cases>



• **The main unit or AC adaptor is deformed or abnormally hot.**

• **The main unit or AC adaptor smells of burning.**

• **There is abnormal sound during use or charging of the main unit or AC adaptor.**

- Immediately request inspection or repair at an authorized service center.

► This product

This product has a built-in rechargeable battery. Do not throw into flame or heat.



- Doing so may cause fluid leak, overheating, or explosion.

Do not modify or repair.



- Doing so may cause fire, electric shock, or injury. Contact an authorized service center for repair (battery change, etc.).

Never disassemble except when disposing of the product.



- Doing so may cause fire, electric shock, or injury.

WARNING

► Preventing accidents

 **Do not store within the reach of children or infants. Do not let them use it.**
- Putting parts or accessories in the mouth may cause an accident or injury.

If the oil is consumed accidentally, do not induce vomiting, drink a large amount of water, and contact a physician.

 **If the oil comes into contact with eyes, immediately wash thoroughly with running water, and contact a physician.**
- Failure to do so may result in physical problems.

This appliance is not intended for use by persons (including children) with reduced physical, sensory or mental capabilities, or lack of experience and knowledge, unless they have been given supervision or instruction concerning use of the appliance by a person responsible for their safety.

 **Children should be supervised to ensure that they do not play with the appliance.**
- Failure to do so may cause an accident or injury.

If the supply cord is damaged, it must be replaced by the manufacturer, its service agent or similarly qualified persons in order to avoid a hazard.
- Failure to do so may cause an accident or injury.

CAUTION

► Protecting the skin

Do not press the blade strongly the skin. Do not use the clipper for any purpose other than hair trimming.
 **Do not directly apply the blades on ears or rough skin (such as swellings, injuries or blemishes).**
- Doing so may cause injury to ears or uneven skin.

 **Check that the blades are not damaged or deformed before use.**
- Failure to do so may cause skin injury.

► Note the following precautions

Do not allow metal objects or trash to adhere to the power plug or the charging plug.
 - Doing so may cause electric shock or fire due to a short circuit.

 **Do not drop or hit against other objects.**
- Doing so may cause injury.

Do not wrap the cord around the AC adaptor and main body when storing.
 - Doing so may cause the wire in the cord to break with the load, and may cause fire due to short circuit.

Disconnect the power plug from the household outlet when not charging.
 - Failure to do so may cause electric shock or fire due to electrical leakage resulting from insulation deterioration.

CAUTION

-  **Disconnect the power plug by holding onto the power plug instead of the cord.**
 - Failure to do so may cause electric shock or injury.

Handling of the removed battery when disposing

DANGER

- **The rechargeable battery is exclusively for use with this appliance. Do not use the battery with other products.**
- **Do not charge the battery after it has been removed from the product.**
- **Do not throw into fire or apply heat.**
- **Do not solder, disassemble, or modify the battery.**
-  • **Do not let the positive and negative terminals of the battery get in contact with each other through metallic objects.**
- **Do not carry or store the battery together with metallic jewellery such as necklaces and hairpins.**
- **Never peel off the tube.**
 - Doing so may cause fluid leak, overheating, or explosion.

The battery contains alkaline fluid. If it comes in contact with the eyes, do not rub the eyes, and thoroughly rinse with clean water, such as tap water.



- Failure to do so may cause loss of vision.
Consult a physician immediately.

WARNING

After removing the rechargeable battery, do not keep it within reach of children and infants.



- The battery will harm the body if accidentally swallowed.
If this happens, consult a physician immediately.

The battery contains alkaline fluid. If it comes in contact with the skin or clothes, rinse off with clean water, such as tap water.



- Failure to do so may cause skin injury.

Important information

- This clipper is designed for professional use to trim hair. It can be operated on rechargeable battery.
- Apply the oil to the blade before and after each use. (See page 9.)
Failure to apply the oil may cause the following problems.
 - The clipper has become blunt.
 - Shorter operating time.
 - Louder sound.
- You should not allow permanent wave lotion, hair dyeing or hair spray to come into contact with the main body or the blades. Doing so may result in cracking or corrosion.
- Before using an attachment, check that it has been installed correctly. Failure to do so may cause hair to be cut too short.
- The following symbol indicates that a specific detachable power supply unit is required for connecting the electrical appliance to the supply mains. The type reference of power supply unit is marked near the symbol.



- Charge the appliance correctly according to these Operating Instructions. (See page 7 “Charging the clipper”.)
- This appliance contains battery that is only replaceable by skilled persons. Please contact an authorized service center for the details of repair.

豪州向けのため5.2版対応

Parts identification

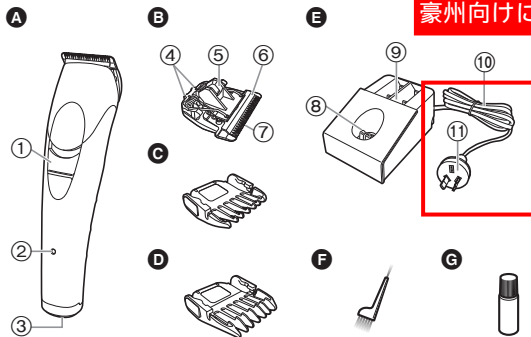

A Main body

- ① Power switch [O / I]
- ② Charge indicator lamp (→)
- ③ Appliance socket

B Blade

- ④ Mounting hook
- ⑤ Cleaning lever
- ⑥ Moving blade
- ⑦ Stationary blade

C 3 mm comb attachment

D 6 mm comb attachment

E AC adaptor (RE9-77)

- ⑧ Charging plug
- ⑨ Comb attachment shelves
- ⑩ Cord
- ⑪ Power plug

Accessories

F Cleaning brush

G Oil

Charging the clipper

- Make sure that the clipper is turned off.

1 Place the clipper on the AC adaptor.

2 Insert the power plug into a household outlet.

- Charging is completed after approx. 8 hours.
- Check the charge indicator lamp (➡) glows.

3 Disconnect the power plug after charging is completed.

(for safety and to reduce energy usage)

- The charge indicator lamp (➡) continues to glow after charging is complete. There is no indication to show that “charging is complete”.

Notes

- If there is noise from the radio or other sources while using or charging the appliance, move to a different location to use the appliance.
- When the appliance is not used for 6 months or more, the battery will weaken (leak battery fluid, etc.). Fully charge the battery once every 6 months.
- When charging the clipper for the first time or when it has not been in use for more than 6 months, the lamp on the main body may not glow for a few minutes, or the operating time may shorten. Please charge it for more than 16 hours in such cases.

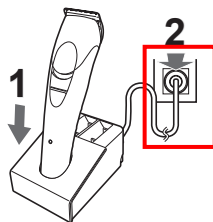

- Recommended ambient temperature for charging is 0 °C – 35 °C. Battery performance may decrease outside of the recommended temperature.
- A full charge will provide approximately 40 minutes of continuous operation. (Based on dry using at 20 °C – 30 °C.)
The operating time may differ depending on the frequency of use and the operating method.
- You can charge the battery before it is completely discharged. However, it is recommended to charge when the battery is completely discharged. The battery life depends strongly on factors such as how it is used and stored.

Using the clipper

- Make sure that the clipper is turned off.
- The appliance may not operate in an ambient temperature approximately 0 °C or lower.

- 1 Select the trimming heights indicated on the insides and sides of the attachments.**
- 2 Slide the power switch on the main body to the “ | ” position to turn on the clipper.**

Removing and mounting the comb attachments

Mounting the attachment

(Example: in the case of 3 mm)

Slide the attachment until it clicks.

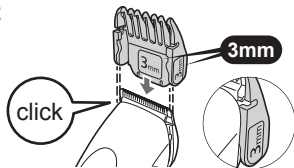

Removing the attachment

Remove the attachment by pressing with your thumb.



Care

- Do not use thinner, benzine, alcohol or other chemicals. Doing so may cause failure, cracking or discoloration of the main body. Clean the main body only with a soft cloth slightly dampened with tap water or soapy tap water.

Removing and mounting the blade

- Make sure that the clipper is turned off.

Removing the blade

Hold the clipper with the switch facing upward and push the blade with your thumb while catching the blade in your other hand.

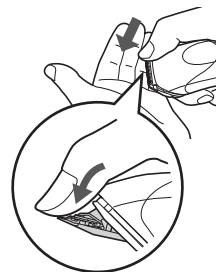

Mounting the blade

Fit the mounting hook into the blade mounting on the clipper and push in until it clicks.

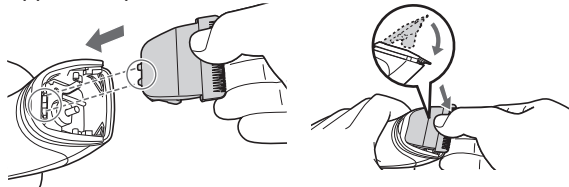

Cleaning

- Clean the clipper and the blade after each use. (If not cleaned, the motion will become poor and the sharpness will worsen.)
- Make sure that the clipper is turned off.

1. Brush off any hairs from the clipper and from around the blade.

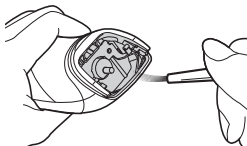

2. Brush off the hairs from the blade edge.

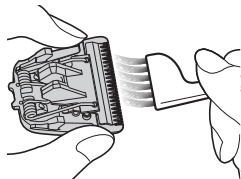

3. Brush the hairs out from between the stationary blade and the moving blade while pressing down on the cleaning lever (a) to raise the moving blade.

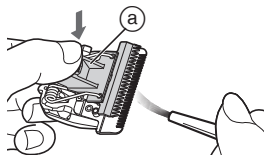

Lubrication

- Apply the oil to the blade before and after each use.

1 Remove the blade. (See page 8.)

2 Apply a drop of the oil to each indicated point.

3 Attach the blade to the main body, turn on the power and allow to run for approximately 5 seconds.

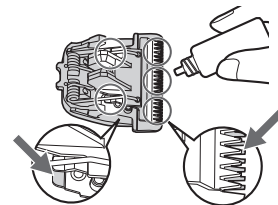

► Replacement parts

Replacement part is available at your dealer or Service Center.

Replacement parts for ER-GP21	Blade	WER9352
----------------------------------	-------	---------

Cleaning the AC adaptor

Use the cleaning brush to clean hair trimmings and dust in the charging plug, the comb attachment shelves or in the hole on the bottom surface.

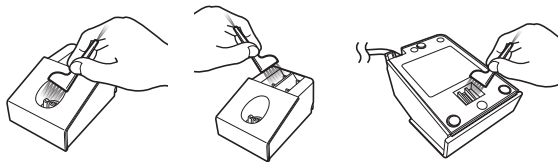

Storing comb attachments

You can store your comb attachments in the comb attachment shelves.



Troubleshooting

Problem	Action
The clipper has become blunt.	Until problems are solved, please follow each procedure as follows; 1. Charge the clipper. (See page 7.) 2. Clean the blade and apply oil. (See page 9.) 3. Replace the blade. (See page 8.) 4. Have the battery replaced by an authorized service center.
Operating time is short.	
Clipper stopped functioning.	
The clipper cannot be charged.	
Makes a loud sound.	Push the main body into the charging stand or appliance plug all the way. Charge within the recommended charging temperature of 0 °C to 35 °C. Apply oil. (See page 9.) Have the battery replaced by an authorized service center.

If the problems still cannot be solved, contact the store where you purchased the appliance or a service center authorised by Panasonic for repair.

Removing the built-in rechargeable battery

Remove the built-in rechargeable battery before disposing the clipper.

The battery is to be disposed of safely.

Please make sure that the battery is disposed of at an officially designated location if there is one.

This figure must only be used when disposing the clipper, and must not be used to repair it. If you dismantle the clipper yourself, it may cause malfunction.

- Remove the clipper from the AC adaptor.
- Slide the power switch to turn on the power and then keep the power on until the battery is completely discharged.
- Perform steps ① to ⑧ and lift the battery, and then remove it.
- Take care not to short circuit the positive and negative terminals of the removed battery, and insulate the terminals by applying tape to them.

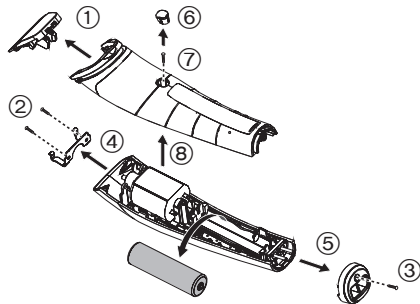

For environmental protection and recycling of materials

This clipper contains a Nickel-Metal Hydride battery. Please make sure that the battery is disposed of at an officially assigned location, if there is one in your country.

Specifications

Power source	See the name plate on the AC adaptor.
Motor voltage	1.2 V ---
Charging time	Approx. 8 hours

Panasonic Corporation
<http://www.panasonic.com>
© Panasonic Corporation 2019