

Panasonic[®]

Operating Instructions for advanced features

Digital Camera

Model No. **DC-LX100M2**



LUMIX

Please read these instructions carefully before using this product,
and save this manual for future use.

Message Display

P290

Troubleshooting

P292

Finding the information you need

P2

Contents

P4

Contents by Function

P9

Menu list

P171

DVQP1786ZA





F0918SQ0



Finding the information you need

In this “Operating Instructions for advanced features”, you can find the information you need from the following pages.

By clicking a page number, you can jump to the linked page and quickly find the information.

	Search from “Contents”	P4
	Click this icon to jump to “Contents”.	
	Search from the list of function names	P9
	Search from the list of buttons and dials	P15
	Search from the list of screens and icons	P284
	Search from “Message Display”	P290
	Search from “Menu list”	P171
	Click this icon to jump to “Menu list”.	
	Search from “Troubleshooting”	P292



1

Click this icon to jump to “Finding the information you need”.



4

Click this icon to return to the previously displayed page.

How to use this manual

About the indication of the applicable mode

Applicable modes:   **P A S M**

The icons indicate the modes available for a function.

- Black icons: Applicable modes
- Grey icons: Unavailable modes

About the symbols in the text

MENU: Indicates that the menu can be set by pressing [MENU/SET] button.

Wi-Fi: Indicates that the Wi-Fi setting can be made by pressing [Wi-Fi] button.



: Tips for skilful use and points for recording.

: Conditions in which a particular function cannot be used.

- Click a cross reference in the text to jump to the corresponding page.

Steps for setting a menu item are described as follows.

Example: In the [Rec] menu, change [Quality] from  to .

MENU →  [Rec] → [Quality] → 

Contents

Finding the information you need	2
How to use this manual	3
Contents by Function	9

1. Before Use

Care of the camera	12
Standard Accessories	14
Names and Functions of Components	15

2. Getting Started/Basic Operations

Attaching the Lens Cap/Shoulder Strap	17
Charging the Battery	19
• Inserting the battery	20
• Charging	21
• Approximate operating time and number of recordable pictures	24
Inserting and removing the card (optional).....	26
Card Information	27
• Formatting the card (initialisation)	28
• Approximate number of recordable pictures and available recording time	29
Setting Date/Time (Clock Set).....	32
Basic Operations.....	34
• Tips for taking good pictures	34
• Using the Viewfinder.....	35
• Zoom operations	36
• Shutter button (Taking pictures)	37
• Motion picture button (Recording motion pictures).....	38
• Select the recording mode	38
• Control Dial.....	40
• Cursor button/[MENU/SET] button	40
• [DISP.] button (Switching the displayed information).....	40
• Touch screen (Touch operations)	43
• Taking Pictures Using the Touch Function	44
Setting menu items	46
Calling frequently-used menus instantly (Quick Menu).....	48
• Customising the Quick Menu settings	49
Assigning Frequently-Used Functions to Buttons (Function Buttons).....	50
Changing settings using the control ring	54
• Changing the function assigned to the control ring	55
Entering Text	56

3. Recording Modes

Taking Pictures using the Automatic Function (Intelligent Auto Mode)	57
• [Intelligent Auto] menu	60
• Taking pictures with customised colour, defocus control, and brightness settings	61
Taking Pictures with Automatically Adjusted Aperture and Shutter Speed (Programme AE Mode)	62
Taking Pictures by Specifying the Aperture/Shutter Speed	64
• Confirm the Effects of Aperture and Shutter Speed (Preview Mode)	70
Registering your preferred settings (Custom Set)	71
• Registering Personal Menu Settings (Registering custom settings)	71
• Calling up a registered set of custom settings	71

4. Focus, Brightness (Exposure) and Colour tone Settings

Adjusting Focus Automatically	73
• Setting the Focus Mode (AFS/AFF/AFC)	75
• Setting the Auto Focus Mode	76
• Changing the position and size of the AF area	82
• Specifying the AF area position with the Touch Pad	85
• Specifying the AF area position with the Touch Function	86
Taking Close-up Pictures	87
Adjusting Focus Manually	88
Fixing the Focus and the Exposure (AF/AE Lock)	90
Compensating the Exposure	91
Setting the Light Sensitivity	93
Adjusting the White Balance	95
• Finely adjusting the White Balance	97

5. 4K Photo and Drive Settings

Select a Drive Mode	98
Taking Pictures using Burst Mode	99
Recording 4K Photos	101
• Notes on the 4K Photo function	103
Selecting pictures from 4K burst file and saving	106
• Operations during selecting pictures	107
Controlling Focus After Recording (Post Focus/Focus Stacking)	111
• Selecting the desired focus area and saving a picture (Post Focus)	113
• Merging multiple pictures to widen the focus range (Focus Stacking)	114
Taking Pictures with the Self-timer	116
Recording panorama pictures	118

6. Recording Images that Suit Your Subjects and Purposes

Changing the Aspect Ratio	122
Taking Pictures with different image effects (Filter).....	123
• Types of image effects.....	125
• Taking a picture with and without an image effect simultaneously ([Simultaneous Record w/o Filter]).....	129
Taking Pictures While Adjusting a Setting Automatically (Bracket Recording).....	130
• Exposure Bracket	132
• Aperture Bracket	132
• Focus Bracket	133
• White Balance Bracket.....	133
Taking Pictures Automatically at Set Intervals ([Time Lapse Shot]).....	134
Creating Stop Motion Pictures ([Stop Motion Animation]).....	137

7. Stabiliser, Zoom and Flash

Image Stabiliser.....	140
Taking Pictures with the Zoom	142
• Zoom types and use	142
• Zooming using touch operations (Touch zoom)	146
Taking pictures using the flash (supplied)	147
• Attaching the flash	147
Setting the Flash Functions	149
• Changing the firing mode	149
• Changing Flash Mode	150
• Setting to the 2nd Curtain Synchro.....	151
• Adjust the flash output.....	152
• Synchronising the output of the flash to the Exposure Compensation	152
Taking Pictures with Wireless Flashes.....	153

8. Recording Motion Pictures

Recording Motion Picture.....	156
• Setting the recording format and recording quality.....	158
• How to set focus when recording a motion picture ([Continuous AF])	160
• Recording still pictures while recording motion pictures.....	161
• Displaying/setting the sound input level	162

9. Playing Back and Editing Images

Playing Back Pictures	163
Playing Back Motion Pictures.....	164
• Creating Still Pictures from a Motion Picture	165
Switching the Playback Method	166
• Using the Playback Zoom	166
• Displaying multiple screens (Multi Playback)	167
• Displaying Pictures by Recording Date (Calendar Playback)	167
Playing Back Group Pictures	168
Deleting Pictures.....	170

10. Using Menu Functions

Menu list.....	171
• [Intelligent Auto] menu.....	171
• [Rec] menu.....	171
• [Motion Picture] menu.....	184
• [Custom] menu.....	185
• [Setup] menu.....	200
• [My Menu] menu.....	209
• [Playback] menu.....	210

11. Using the Wi-Fi/Bluetooth function

What you can do with the Wi-Fi®/Bluetooth® function.....	227
Wi-Fi function/Bluetooth function.....	228
Connecting to a smartphone.....	230
• Installing the smartphone/tablet app “Panasonic Image App”.....	230
• Connecting the camera to a smartphone compatible with Bluetooth low energy.....	231
• Connecting the camera to a smartphone that does not support for Bluetooth low energy.....	233
• Changing the Wi-Fi connection method.....	235
• Terminating the Wi-Fi connection.....	236
Controlling with a Smartphone.....	237
• Turning on/off the camera with a smartphone.....	237
• Taking images via a smartphone (remote recording).....	238
• Operating the shutter button with a smartphone via a Bluetooth connection alone.....	240
• Playing back/saving images stored on the camera, or uploading them on social media sites.....	242
• Transferring recorded images to a smartphone automatically.....	243
• Writing location information of a smartphone on a recorded image.....	245
• Synchronising the camera’s clock with a smartphone.....	246
Displaying pictures on a TV.....	247
Sending images.....	248
Sending images to a smartphone.....	251
Printing Wirelessly.....	252
Sending images to AV device.....	253
Sending images to PC.....	254
Using Web services.....	256
• When sending images to web service.....	256
• When sending images to [Cloud Sync. Service].....	259
• About the [LUMIX CLUB].....	260
About Wi-Fi connections.....	263
• Connecting via a wireless access point ([Via Network]).....	264
• Connecting the camera and another device directly ([Direct]).....	266
• Connecting quickly with the same settings as the previous ones ([Select a destination from History]/[Select a destination from Favorite]).....	267
[Wi-Fi Setup] Menu.....	269

12. Connecting to other equipment

Watching/Saving 4K Motion Pictures on an External Device	271
• Watching motion pictures in 4K	271
• Storing 4K motion pictures	271
Playing Back Pictures on a TV Screen	272
• Using VIERA Link (HDMI)	273
Saving still pictures and motion pictures on your PC	274
• Downloading software	275
• Transferring images to a PC	277
Saving still pictures and motion pictures on a Recorder	279
Printing the Pictures	280
• Adding date and text to pictures	282

13. Others

Optional accessories	283
Monitor Display/Viewfinder Display	284
Message Display	290
Troubleshooting	292
Cautions for Use	301

Contents by Function



Recording

Recording

Recording Mode	P38
[Preview].....	P70
Macro recording	P87
Bracket Recording	P130
[Time Lapse Shot]	P134
[Stop Motion Animation]	P137
[Silent Mode]	P180
[Multi Exp.].....	P183

4K photo

[4K PHOTO]	P101
[Post Focus]	P111

Focus (AF/MF)

Auto focus	P75
[AF Mode].....	P76
Adjusting the AF area position	P82
Manual Focus	P88
[AF/AE Lock]	P90

Drive

[Drive Mode]	P98
[Burst]	P99
[Self Timer]	P116
Panorama	P118

Picture Quality and Colour Tone

[Sensitivity].....	P93
[White Balance].....	P95
[Picture Size].....	P172
[Quality].....	P173
[Photo Style]	P174
[Filter Settings].....	P123
[Color Space]	P176
[Highlight Shadow]	P177
[i.Dynamic]	P178
[i.Resolution]	P178
[Long Shtr NR]	P179
[Diffraction Compensation]	P180
[HDR]	P182

Exposure

[Touch AE]	P45
[AF/AE Lock].....	P90
Exposure Compensation	P91
Exposure Bracket	P132
[Metering Mode].....	P176

Flash

[Flash Mode]	P150
2nd curtain synchro	P151
[Flash Adjust.]	P152
Wireless flash settings	P153

**Motion Picture****Motion Picture**

[Rec Format]/[Rec Quality]	P158
Recording still pictures while recording motion pictures	P161

Audio

[Sound Rec Level Adj.]	P162
[Wind Noise Canceller]	P184

Screen settings

[Sound Rec Level Disp.]	P162
[Monochrome Live View]	P192
[Center Marker]	P194
[Zebra Pattern]	P195

**Setup/Custom****Basic settings**

[Format]	P28
[Clock Set]	P32
Dioptre adjustment	P35
[Q.MENU]	P48
[Beep]	P202
[Economy]	P203
[Reset] (initialisation)	P208

Customisation

Function buttons	P50
Custom Set	P71
[Custom] menu	P185

**Playback****Playback**

Picture playback	P163
Motion picture playback	P164
Playback Zoom	P166
Multi Playback	P167
Delete	P170
[Auto Review]	P191
[Slide Show]	P211
[Rotate]/[Rotate Disp.]	P224, 225

Edit

Post Focus	P113
Focus Stacking	P114
[RAW Processing]	P215
[4K PHOTO Bulk Saving]	P217
[Light Composition]	P218
[Sequence Composition]	P219
[Clear Retouch]	P220
[Resize]	P222
[Cropping]	P223
[Title Edit]	P214
[Text Stamp]	P221

Image settings

[Protect]	P213
[Rating]	P213

**Wi-Fi/Bluetooth****Image App**

“Image App”	P230
[Remote Wakeup].....	P237
Remote recording.....	P238
[Auto Transfer].....	P243

In combination with other devices

Playing back pictures on a TV	P247
Printing images	P252
Sending images to an AV device.....	P253
Sending images to a PC	P254
Sending images to a web service.....	P256
Using cloud sync services	P259

**Connections with other devices****PC**

“PHOTOfunSTUDIO”	P275
“SILKYPIX Developer Studio”	P276
Transferring images to a PC	P254

Recorder

Dubbing	P279
---------------	------

Printer

PictBridge	P280
------------------	------

TV

Playing Back Pictures on a TV Screen	P272
[VIERA Link]	P273

Care of the camera

■ Handling of the camera

Do not subject to strong vibration, shock, or pressure.

Avoid using the camera under the following conditions, which may damage the lens, monitor, viewfinder, or external case.

This may also cause the camera to malfunction or prevent recording.

- Drop or hit the camera.
- Sitting down with the camera in your pants pocket or forcing it into a full bag.
- Press hard on the lens or the monitor.

The camera is not dust resistant, splash resistant, or waterproof.

Avoid using the camera in places with excessive dust or sand, or where water can come into contact with the camera.

- Avoid using the camera under the following conditions, which present a risk that sand, water, or foreign material may enter the camera through the lens or openings around buttons. Be especially careful because these conditions may damage the camera, and such damage may not be repairable.
 - In extremely dusty or sandy places.
 - In the rain or by the shore, where the camera may be exposed to water.

■ About Condensation (When the lens, the viewfinder or monitor is fogged up)

- Condensation occurs when the ambient temperature or humidity changes. Be careful of condensation since it causes lens, viewfinder and monitor stains, fungus and camera malfunction.
- If condensation occurs, turn the camera off and leave it for about 2 hours. The fog will disappear naturally when the temperature of the camera becomes close to the ambient temperature.

■ **Always record a test image first**

Before important events when you will use the camera (at weddings, for example), always record a test image to ensure that images and sound record correctly.

■ **No compensation for missed shots**

We cannot compensate for missed shots if technical problems with the camera or card prevent images and/or sound from being recorded.

■ **Carefully observe copyright laws**

Unauthorised use of recorded images and sound that contain works with copyright for purposes other than personal use is prohibited under copyright law. Recording of certain material may be restricted even for the purpose of personal use.

■ **Please also refer to “Cautions for Use” (P301)**

■ **Before using the camera, be sure to check that the accessories listed in the supplied booklet “Basic Operating Instructions” are present.**

For details on the optional accessories, refer to [P283](#) of these operating instructions and the supplied booklet “Basic Operating Instructions”.



MENU



Standard Accessories

Check that all the accessories are supplied before using the camera.

- The accessories and their shape will differ depending on the country or area where the camera was purchased.
For details on the accessories, refer to “Basic Operating Instructions”.
- Battery Pack is indicated as **battery pack** or **battery** in the text.
- AC Adaptor is indicated as **AC adaptor (supplied)** in the text.
- SD Memory Card, SDHC Memory Card and SDXC Memory Card are indicated as **card** in the text.
- **The card is optional.**



MENU



Names and Functions of Components

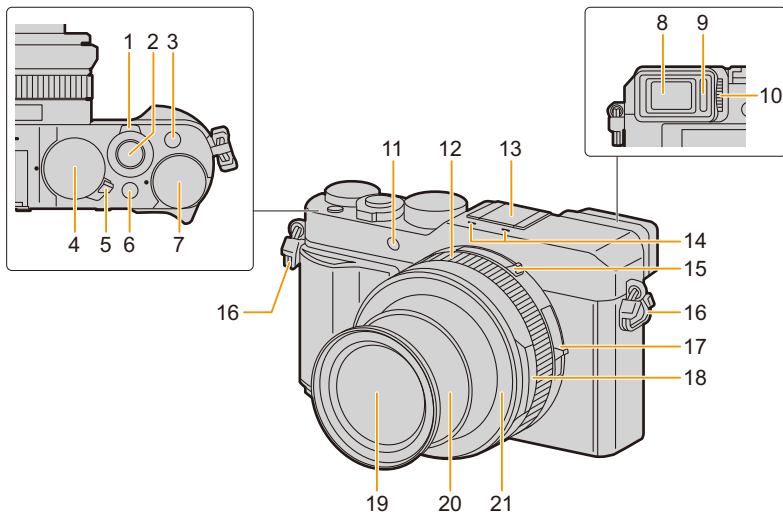

1 Zoom lever (P36)	13 Hot shoe (Hot shoe cover) (P147)
2 Shutter button (P37)	Stereo microphone (P34, 162)
3 [Fn1] button (P50, 101)	14 • Be careful not to cover the microphone with your finger. Doing so may make sound difficult to record.
4 Shutter speed dial (P38, 64)	15 Aspect ratio selector switch (P122)
5 Camera ON/OFF switch (P32)	16 Shoulder strap eyelet (P17)
6 [iA] button (P39, 57)	17 Focus selector switch (P73, 87, 88)
7 Exposure compensation dial (P91)	18 Aperture ring (P38, 64)
8 Viewfinder (P35)	19 Lens (Filter diameter: \varnothing 43 mm)
9 Eye sensor (P35)	20 Lens barrel
10 Dioptre adjustment dial (P35)	21 Lens front ring • To attach the auto lens cap (optional), remove the lens front ring.
11 Self-timer indicator (P116)/ AF Assist Lamp (P34, 187)	
12 Control ring (P55)	

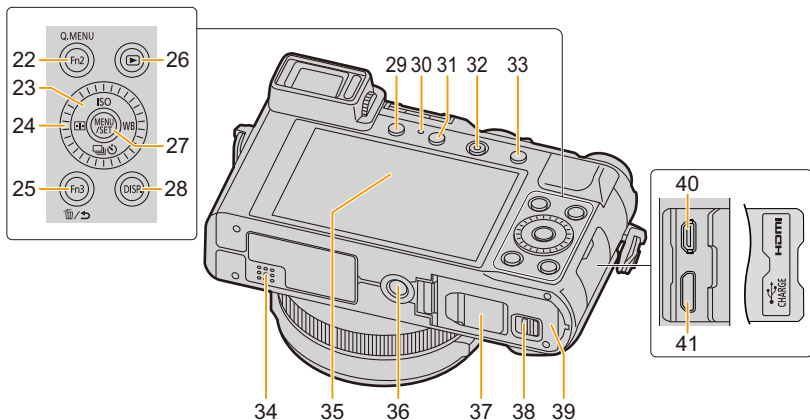

22 [Q.MENU] button (P48)/[Fn2] button (P50)	32 Motion picture button (P156)
Cursor button (P40) ▲: [ISO] (ISO sensitivity) button (P93)	33 [AF/AE LOCK] button (P90)
23 ►: [WB] (White Balance) button (P95) ▼: [] (Drive Mode) (P98) ◀: [] (Auto Focus Mode) button (P76)	34 Speaker (P34, 202)
24 Control dial (P40)	35 Touch screen (P43)/Monitor (P284)
[Fn3] button (P50, 70)/	36 Tripod mount (P304) • It may not be possible to attach and securely fasten a tripod with a screw length of 5.5 mm (0.22 inch) or more to the camera. Doing so may also damage the camera.
25 [] (Delete) button (P170)/ [] (Cancel) button (P47)	37 DC coupler cover (P283) • When using an AC adaptor, ensure that the Panasonic DC coupler (optional) and AC adaptor (optional) are used.
26 [] (Playback) button (P163)	38 Release lever (P20)
27 [MENU/SET] button (P40, 46)	39 Card/Battery door (P20)
28 [DISP.] button (P40)	40 [HDMI] socket (P272)
29 [LVF] button (P35)/[Fn5] button (P50)	41 [USB/CHARGE] socket (P277, 280)
30 Charging lamp (P21)/ WIRELESS connection lamp (P228)	
31 [Fn4] button (P50, 111)	

• **Function buttons ([Fn6] to [Fn10]) are touch icons.**

Touch the [Fn] tab on the recording screen to display them.

Attaching the Lens Cap/Shoulder Strap

When the camera is not in use, attach the lens cap to protect the lens.

- We recommend attaching the lens cap to the camera using the lens cap string to prevent loss of the lens cap.
- Attach the shoulder strap when using the camera to prevent it from dropping.

1 Use the lens cap string (supplied) to attach the lens cap to the camera.

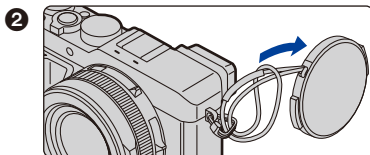
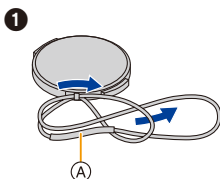

- (A): Make sure that the thicker portion of the string is not hanging over the lens cap or the shoulder strap eyelet.

2 Attach the lens cap.

- To attach and remove the lens cap, press the areas shown by arrows in the illustration.

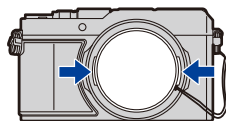

3 Attach the shoulder strap.

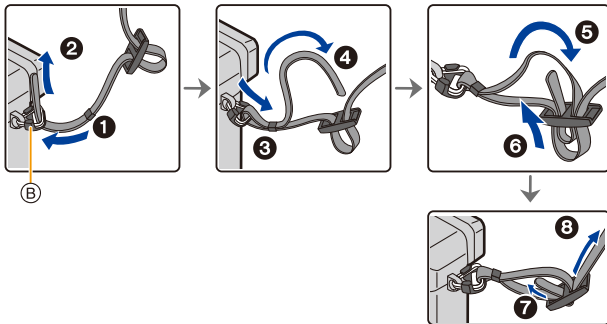

Ⓑ: Shoulder strap eyelet

- In addition, attach the other side of the shoulder strap in the same manner.
 - Make sure that the shoulder strap does not come loose.
- Use the shoulder strap around your shoulder.
 - Do not wrap the strap around your neck. It may result in injury or accident.
 - Do not leave the shoulder strap where an infant can reach it.
 - It may result in an accident by mistakenly wrapping around the neck.
 - Keep the lens cap string out of reach of children to prevent swallowing.

Charging the Battery

- Battery Pack is indicated as the **battery** in these operating instructions.
- Use the dedicated AC adaptor (supplied), USB connection cable (supplied) and battery.
- **The battery is not charged when the camera is shipped. Charge the battery before use.**
- **Charge the battery only when it is inserted in the camera.**

Camera conditions	Charge
Turned off	○
Turned on	—

■ About batteries that you can use with this unit

It has been found that counterfeit battery packs which look very similar to the genuine product are made available for purchase in some markets. Some of these battery packs are not adequately protected with internal protection to meet the requirements of appropriate safety standards. There is a possibility that these battery packs may lead to fire or explosion. Please be advised that we are not liable for any accident or failure occurring as a result of use of a counterfeit battery pack. To ensure that safe products are used, we recommend that a genuine Panasonic battery pack is used.

Inserting the battery

1 Slide the release lever **A** to the [OPEN] position and open the card/battery door.

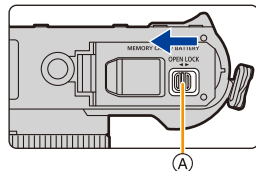

2 Insert the battery **B** all the way in until you hear a locking sound, and then confirm that it is locked by the lever **C**.

- Check the orientation of the battery.

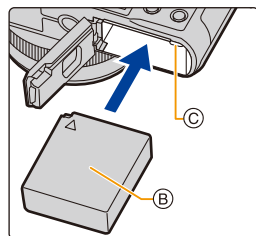

3 Close the card/battery door and slide the release lever to the [LOCK] position.

■ To remove

Pull the lever **D** in the direction of the arrow to remove.

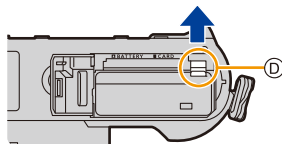

- Turn the camera off and wait for the "LUMIX" display on the monitor to clear before removing the battery. (Otherwise, this unit may no longer operate normally and the card itself may be damaged or the recorded pictures may be lost.)
- Remove the battery after use.

Charging

Charge the battery in areas with an ambient temperature, between 10 °C and 30 °C (50 °F and 86 °F) (same as the battery temperature), is recommended.

Insert the battery into this unit. (P20)
Check that the camera on/off switch is set to [OFF].

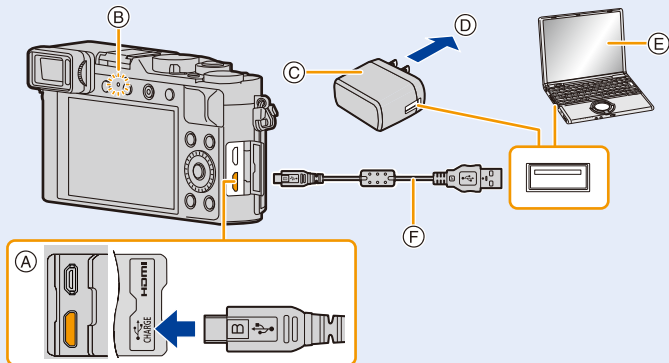

- Ⓐ Connect the USB connection cable (supplied) to the [USB/CHARGE] socket.
 - Place the camera in an upright position, and find the terminal at the bottom.
- Ⓑ Charging lamp
- Ⓒ AC adaptor (supplied)
- Ⓓ To power outlet
- Ⓔ PC (Turned on)
- Ⓕ USB connection cable (supplied)

- Check the direction of the terminals and plug in/out straight holding onto the plug. (It may result in malfunction by the deforming of the terminal if it is plugged in obliquely or in wrong direction.) Do not connect devices to incorrect terminals. Doing so may cause malfunction.

(Charging from the power outlet)

Connect the AC adaptor (supplied) and this camera with the USB connection cable (supplied), and insert the AC adaptor (supplied) into the power outlet.

(Charging from a computer)

Connect the computer and this camera with the USB connection cable (supplied).

- If the computer enters a suspended state while charging the battery, charging will stop.
- Connecting this camera to a notebook computer that is not connected to a power outlet will cause the notebook computer battery to drain faster. Do not leave the camera connected for extended periods of time.
- Be sure to always connect the camera to a computer USB terminal. Do not connect the camera to a monitor, keyboard or printer USB terminal, or a USB hub.

■ About the charging lamp

Lit red: Charging.
Off: Charging has completed.
(When charging is complete, disconnect the camera from the power outlet or computer.)

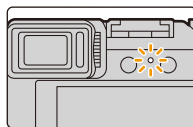

• When the charging lamp flashes

- This occurs when charging is performed in an extremely hot or cold location. Reconnect the USB connection cable (supplied) in a location where the ambient temperature (and the temperature of battery) is in a 10 °C to 30 °C (50 °F to 86 °F) range, and try charging again.
- If your PC is not capable of supplying sufficient power, charging is not possible.

■ Charging time

When using the AC adaptor (supplied)

Charging time

Approx. 190 min

- **The indicated charging time is for when the battery has been discharged completely. The charging time may vary depending on how the battery has been used. The charging time for the battery in hot/cold environments or a battery that has not been used for a long time may be longer than normal.**
- When power is supplied from a computer, the power supply capacity of the computer determines the charging time.

■ Battery indication

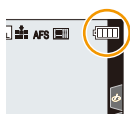

	75% or higher
	74% to 50%
	49% to 25%
	24% or below
 Blinking red	Low battery • Recharge the battery or replace it with a fully charged battery.

- The battery level indicated on the screen is approximate. The exact level varies depending on the environment and the operating conditions.

- **Do not leave any metal items (such as clips) near the contact areas of the power plug. Otherwise, a fire and/or electric shocks may be caused by short-circuiting or the resulting heat generated.**
- Do not use any other USB connection cables except the supplied one.
This may cause malfunction.
- Do not use any other AC adaptors except the supplied one.
This may cause malfunction.
- Do not use a USB extension cable.
- Do not use the AC adaptor (supplied) and the USB connection cable (supplied) for other devices. Doing so may cause malfunction.
- Remove the battery after use. (The battery will be exhausted if left for a long period of time after being charged.)
- **The battery becomes warm after using it and during and after charging. The camera also becomes warm during use. This is not a malfunction.**
- The battery can be recharged even when it still has some charge left, but it is not recommended that the battery charge be frequently topped up while the battery is fully charged. (Since characteristic swelling may occur.)
- If a problem occurs in the power outlet, such as a power outage, charging may not be completed normally. If this happens, disconnect the USB connection cable (supplied) and connect it again.
- The AC adaptor is in the standby condition when the mains plug is connected. The primary circuit is always “live” as long as the mains plug is connected to an electrical outlet.



MENU



Approximate operating time and number of recordable pictures

- The numbers of recordable pictures listed here are based on the CIPA (Camera & Imaging Products Association) standard.
- When a Panasonic SDHC memory card and the supplied battery are used.

■ Recording still pictures (when using the Monitor)

Flash (supplied)	Not used	Used
Number of recordable pictures	Approx. 340 pictures	Approx. 300 pictures
Recording time	Approx. 170 min	Approx. 150 min

■ Recording still pictures (when using the Viewfinder)

The values inside the parentheses apply when [LVF Display Speed] is set to [ECO30fps].

Flash (supplied)	Not used	Used
Number of recordable pictures	Approx. 270 pictures (Approx. 320 pictures)	Approx. 240 pictures (Approx. 280 pictures)
Recording time	Approx. 135 min	Approx. 120 min

■ Recording motion pictures (when using the Monitor)

[Rec Format]	[AVCHD]	[MP4]	
[Rec Quality]	[FHD/17M/50i]	[FHD/28M/60p] [FHD/28M/50p]	[4K/100M/30p] [4K/100M/25p]
Available recording time	Approx. 90 min	Approx. 80 min	Approx. 70 min
Actual available recording time	Approx. 45 min	Approx. 40 min	Approx. 35 min

- Actual recordable time is the time available for recording when repeating actions such as turning this unit on and off, starting/stopping recording, etc.

■ Playback (when using the Monitor)

Playback time	Approx. 240 min
---------------	-----------------

- **The operating times and number of recordable pictures will differ according to the environment and the operating conditions.**

For example, in the following cases, the operating times shorten and the number of recordable pictures is reduced.

- In low-temperature environments, such as on ski slopes.
- When a function such as flash or zoom is used repeatedly.
- When the operating time of the camera becomes extremely short even immediately after charging, the life of the battery has expired. Buy a new battery.



MENU



Inserting and removing the card (optional)

- Check that the camera on/off switch is set to [OFF].

1 Slide the release lever (A) to the [OPEN] position and open the card/battery door.

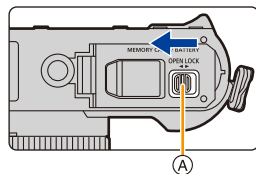

2 Insert the card (B) all the way in until you hear a clicking sound.

- Check the orientation of the card.
- Do not touch the card terminals (C).

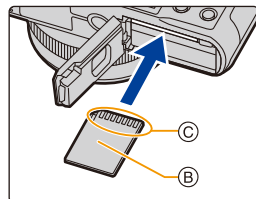

3 Close the card/battery door and slide the release lever to the [LOCK] position.

■ To remove

Insert until a clicking sound is heard and then pull it straight out.

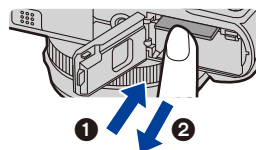

- Turn the camera off and wait for the "LUMIX" display on the monitor to clear before removing the card. (Otherwise, this unit may no longer operate normally and the card itself may be damaged or the recorded pictures may be lost.)





Card Information

The following cards which conform to the SD standard can be used with this unit.
(These cards are indicated as **card** in the text.)

SD Memory Card (512 MB to 2 GB)	<ul style="list-style-type: none"> This unit is compatible with UHS-I UHS Speed Class 3 standard SDHC/SDXC memory cards. Operation of the cards on the left has been confirmed with Panasonic's cards.
SDHC Memory Card (4 GB to 32 GB)	
SDXC Memory Card (48 GB to 128 GB)	

■ Recording of motion pictures/4K photos and speed class ratings

- Use a card that meets the following ratings of the SD Speed Class or UHS Speed Class.
- SD Speed Class and UHS Speed Class are the speed standards regarding continuous writing. To check the class, see the labelled side, etc. of the card.

[Rec Format]	[Rec Quality]	Speed class	Label example
[AVCHD]	All	Class 4 or higher	CLASS  
	FHD/HD		
[MP4]	4K	UHS Speed Class 3	
When recording in 4K Photo/ [Post Focus]		UHS Speed Class 3	

- For the most updated information:
<http://panasonic.jp/support/global/cs/dsc/>
(This Site is English only.)

Access to the card

The access indication displays red when pictures are being recorded on the card.



• **Do not perform the operations below while the card is being accessed (while image data is being written or read or deletion or formatting is in progress, for example). These operations may damage the card or recorded data or cause the camera to stop functioning correctly.**

- Turning off the camera
- Removing the battery or card, or disconnect the AC adaptor (optional) and DC coupler (optional)
- Exposing the camera to vibration, impact or static electricity

• **If operation fails due to vibration, impact or static electricity, perform the operation again.**

- If you set the Write-Protect switch (A) to "LOCK", you may not be able to write, delete or format the data or display it by recording date.
- The data on the card may be damaged or lost due to electromagnetic waves, static electricity or breakdown of the camera or the card. We recommend storing important data on a PC etc.
- Keep the memory card out of reach of children to prevent swallowing.

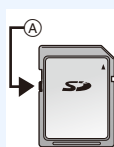

Formatting the card (initialisation)

Format the card before recording a picture with this unit.

After formatting, all data stored on the card will be deleted and cannot be recovered. Back up necessary data on a PC or similar device first, and then format the card.

MENU → **Setup** → **Format**

- This requires a sufficiently charged battery, or an AC adaptor (optional) and DC coupler (optional).
- Do not turn off the camera or perform other operations during formatting.
- Always format cards with this camera. Please reformat the card with this camera if it has already been formatted with a computer or another device.

Approximate number of recordable pictures and available recording time

■ Number of recordable pictures

• Aspect ratio [4:3], Quality [FINE]

[Picture Size]	Card capacity			
	16 GB	32 GB	64 GB	128 GB
L (17M)	1710	3430	6860	13580
EX M (8.5M)	3120	6260	12350	24460
EX S (4M)	5350	10730	20590	40760

• Aspect ratio [4:3], Quality [RAW]

[Picture Size]	Card capacity			
	16 GB	32 GB	64 GB	128 GB
L (17M)	530	1070	2150	4270
EX M (8.5M)	620	1250	2500	4960
EX S (4M)	680	1360	2720	5400

■ Available recording time (when recording motion pictures)

- “h” is an abbreviation for hour, “m” for minute and “s” for second.
- The recordable time is the total time of all the motion pictures which have been recorded.

• [AVCHD]

[Rec Quality]	Card capacity			
	16 GB	32 GB	64 GB	128 GB
[FHD/28M/50p]	1h10m	2h30m	5h00m	9h55m
[FHD/17M/50i]	2h00m	4h05m	8h15m	16h25m
[FHD/24M/25p] [FHD/24M/24p]	1h25m	2h55m	5h50m	11h35m

• [MP4]

[Rec Quality]	Card capacity			
	16 GB	32 GB	64 GB	128 GB
[4K/100M/30p] [4K/100M/25p] [4K/100M/24p]	20m00s	41m00s	1h25m	2h50m
[FHD/28M/60p] [FHD/28M/50p]	1h10m	2h25m	5h00m	9h55m
[FHD/20M/30p] [FHD/20M/25p]	1h35m	3h15m	6h40m	13h15m
[HD/10M/30p] [HD/10M/25p]	3h05m	6h20m	12h45m	25h20m

• Continuous motion picture recordable times

Motion picture recording stops when the continuous recordable times below have elapsed.

[Rec Format]	[Rec Quality]	Continuous recordable time	Size interval for dividing files
[AVCHD]	[FHD/28M/50p]	29 minutes and 59 seconds	Files exceeding 4 GB in size will be divided into smaller files for recording.*
	[FHD/17M/50i]		
	[FHD/24M/25p]		
	[FHD/24M/24p]		
[MP4]	[4K/100M/30p]	15 minutes	When an SDHC card is used: Files exceeding 4 GB in size will be divided into smaller files for recording and playback.* When an SDXC card is used: Files are not divided for recording.
	[4K/100M/25p]		
	[4K/100M/24p]		
	[FHD/28M/60p]	29 minutes and 59 seconds	Files exceeding 4 GB in size will be divided into smaller files for recording and playback.*
	[FHD/28M/50p]		
	[FHD/20M/30p]		
	[FHD/20M/25p]		
	[HD/10M/30p]		
[HD/10M/25p]			

* You can continue recording without interruption.

- Depending on the recording conditions and the type of card, the number of recordable pictures and available recording time vary.
- **The maximum available continuous recording time is displayed on the screen.**
- [9999+] is displayed on the recording screen if there are 10000 or more recordable pictures remaining.

Setting Date/Time (Clock Set)

• The clock is not set when the camera is shipped.

1 Turn the camera on.

- If the language select screen is not displayed, proceed to step 4.

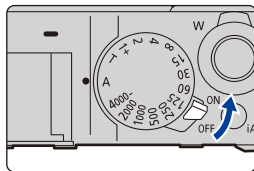

2 Press [MENU/SET].

3 Press ▲/▼ to select the language, and press [MENU/SET].

4 Press [MENU/SET].

5 Press ◀/▶ to select the items (year, month, day, hour, minute), and press ▲/▼ to set.

- Ⓐ: Time at the home area
- Ⓑ: Time at the travel destination

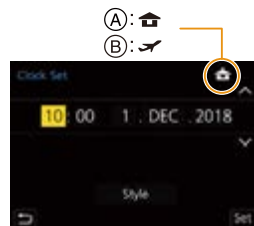

To set the display order and the time display format.

- To display the setting screen of the order/time, select [Style] and then press [MENU/SET].

6 Press [MENU/SET] to set.

7 When [The clock setting has been completed.] is displayed, press [MENU/SET].

8 When [Please set the home area] is displayed, press [MENU/SET].



- 9** Press ◀/▶ to select the home area, and then press [MENU/SET].



■ Re-adjusting the clock

MENU → ⚙ [Setup] → [Clock Set]

- The same screen as in step 5 on P32 is displayed.
- **The clock setting is maintained for 3 months using the built-in clock battery even without the battery.**
(Leave the charged battery in the unit for 24 hours to charge the built-in battery.)
- To place the correct date on pictures, set the clock before recording.

Basic Operations

Tips for taking good pictures

Hold the camera gently with both hands, keep your arms still at your side and stand with your feet slightly apart.

- We recommend using the supplied shoulder strap **(D)** to avoid dropping the camera.
- Do not cover the flash head being used for flash recording **(P147)**, the AF Assist Lamp **(A)**, microphone **(B)**, or speaker **(C)** with your fingers or other objects.
- Make sure that the camera does not move at the moment the shutter button is pressed.
- Make sure your footing is stable and there is no danger of colliding with another person or object in the vicinity while taking pictures.

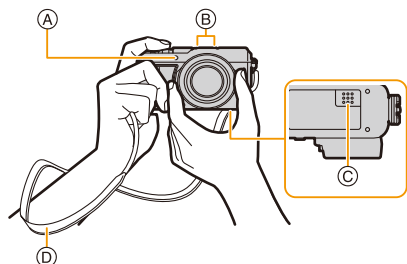

■ Detects orientation of camera (Direction Detection Function)

This function detects the vertical orientation when you record with the camera vertically orientated.

When you play back the recording, the recording is automatically displayed in vertical orientation.

(Only available when [Rotate Disp.] is set to [ON].)



- When the camera is held vertically and tilted significantly up or down to record, the Direction Detection Function may not work correctly.
- Motion pictures, 4K burst files, and images recorded with the Post Focus function cannot be displayed vertically.

Using the Viewfinder

Switching the Monitor/Viewfinder

Press [LVF].

- (A) [LVF] button
- (B) Eye sensor

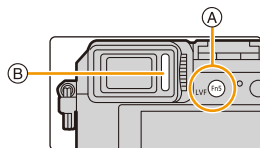

Automatic viewfinder/
monitor switching*

Viewfinder display*

Monitor display

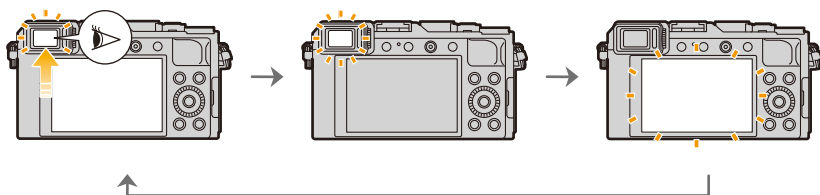

- * If [Eye Sensor AF] in the [Custom] ([Focus / Release Shutter]) menu is set to [ON], the camera automatically adjusts the focus as the eye sensor is activated. The camera does not beep when focus is achieved with [Eye Sensor AF].

■ Notes on automatic viewfinder/monitor switching

Bring your eye or an object near the viewfinder to automatically switch to the viewfinder display using the eye sensor.

Dioptr adjustment

Rotate the dioptre adjustment dial until you can see the characters displayed in the viewfinder clearly.

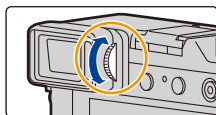



- If [LVF Display Speed] is set to [ECO30fps] when the viewfinder is used, the camera can be operated for a longer period since battery drainage is reduced.
- Eye sensor might not work properly depending on the shape of your eyeglasses, the way you hold the camera, or bright light shining around the eyepiece.
- Automatic viewfinder/monitor switching does not work during motion picture playback and slide shows.

Zoom operations

You can adjust the area of a picture to be taken using the zoom lever or control ring.

- You can also use the zoom function from the touch panel. (P146)
- For details about zoom types and use, refer to P142.

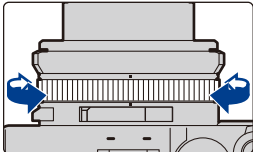
Zoom lever	Control ring
<p>Move the zoom lever</p>  <p>• The operation of the zoom lever is indicated as shown below in these operating instructions.</p> <p>Rotate the zoom lever: </p>	<p>Turn the control ring*</p>  <p>* You can perform zoom operation by assigning the [Zoom] setting to the control ring. (P55)</p>
<p>[T] side: Telephoto, Enlarge the subject</p> <p>[W] side: Wide-angle, Capture a wider area</p>	<p>Clockwise: Telephoto, Enlarge the subject</p> <p>Counterclockwise: Wide-angle, Capture a wider area</p>

- Do not touch the lens barrel during zooming.
- Adjust the focus after adjusting the zoom.
- The camera may make a rattling noise and vibrate when the zoom lever or control ring is operated. This is not a malfunction.

Shutter button (Taking pictures)

The shutter button works in two steps.

1 Press the shutter button halfway to focus.

- (A) Aperture value
- (B) Shutter speed
- (C) Focus indication

- Aperture value and shutter speed are displayed. (It will turn red and blink if the exposure is not correct.)
- Once the subject is in focus, the focus indication is displayed. (When the subject is not in focus, the indication flashes.)

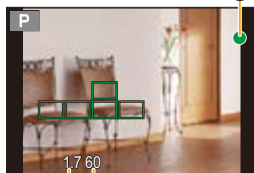
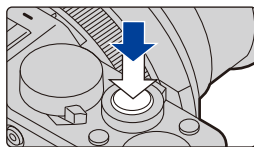

2 Press the shutter button fully (push it in further), and take the picture.

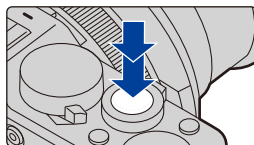

- Pictures cannot be taken until focus is achieved when [Focus/Release Priority] is set to [FOCUS].
- When [Monitor Display Speed] or [LVF Display Speed] (or both) is set to [ECO30fps], Digital Zoom is not available.
- Even during menu operation or image playback, if you press the shutter button halfway, you can instantly set the camera ready for recording.

■ Focus range

Focus range is displayed when operating the zoom. The focus range may change gradually depending on the zoom position.

- (D) Recordable range indication



- The focus range is displayed in red when it is not focused after pressing the shutter button halfway.

Motion picture button (Recording motion pictures)

- Start recording by pressing the motion picture button.**
 - Immediately release the motion picture button.
- Stop the recording by pressing the motion picture picture button again.**

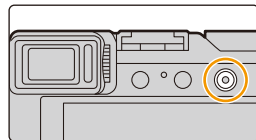

Select the recording mode

Turn the aperture ring (A) and shutter speed dial (B).

- Be sure to align them with the positions where a clicking sound is heard.
- The Recording Mode will change according to the combination of the aperture ring and shutter speed dial positions.

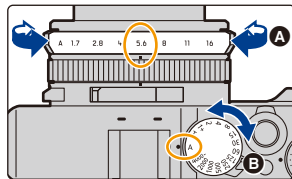

Recording mode	Aperture ring	Shutter speed dial
P Programme AE Mode	[A] (AUTO)	[A] (AUTO)
A Aperture-Priority AE Mode	Setting values other than [A]	
S Shutter-Priority AE Mode	[A] (AUTO)	Setting values other than [A]
M Manual Exposure Mode	Setting values other than [A]	

To switch to Intelligent Auto Mode

Press [iA].

- Intelligent Auto Mode is set and the recording mode icon changes to [iA+] or [iA].
- When you press [iA] again, the recording mode is switched to one that enables settings to be made using the aperture ring and shutter speed dial.

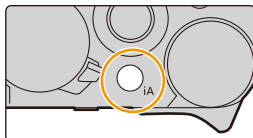

iA	Intelligent Auto Mode (P57)	The camera chooses the optimal settings to match the subject and the recording conditions. We recommend this mode when you want to leave the settings to the camera and take pictures with ease.
iA+	Intelligent Auto Plus Mode (P58)	



P	Programme AE Mode (P62)	The camera automatically sets the shutter speed and the aperture value according to the brightness of the subject.
A	Aperture-Priority AE Mode (P65)	The camera automatically sets the shutter speed according to the brightness of the subject when you set the aperture value.
S	Shutter-Priority AE Mode (P66)	The camera automatically sets the aperture value according to the brightness of the subject when you set the shutter speed.
M	Manual Exposure Mode (P67)	Determine the exposure by manually setting the aperture value and the shutter speed.

Control Dial

Rotating:

Selection of items or setting of values etc., is performed.

- The operation of rotating the control dial is illustrated as below in these operating instructions.

When rotating the control dial to the left or right: 

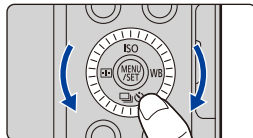

Cursor button/[MENU/SET] button

Pressing the cursor button:

Selection of items or setting of values etc., is performed.

- These operating instructions express the up, down, left, and right of the cursor button as ▲/▼/◀/▶.

Pressing [MENU/SET]:

Confirmation of setting contents, etc., is performed.

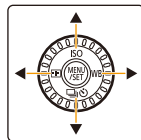

[DISP.] button (Switching the displayed information)

Press [DISP.].

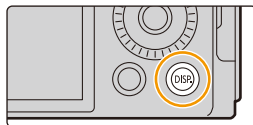

In Recording Mode

You can switch the viewfinder/monitor display method.

MENU → [Custom] → [Monitor / Display] → [LVF/Monitor Disp. Set] → [LVF Disp. Set]/[Monitor Disp. Set]

(viewfinder style)	Scales down images slightly so that you can better review the composition of the images.
(monitor style)	Scales images to fill the entire screen so that you can see their details.

• Viewfinder style (viewfinder display shown as example)

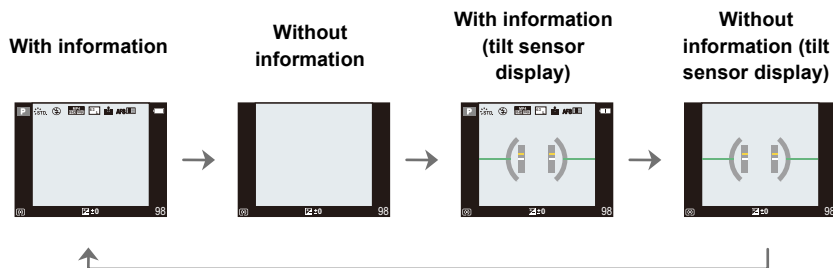

• Monitor style (monitor display shown as example)

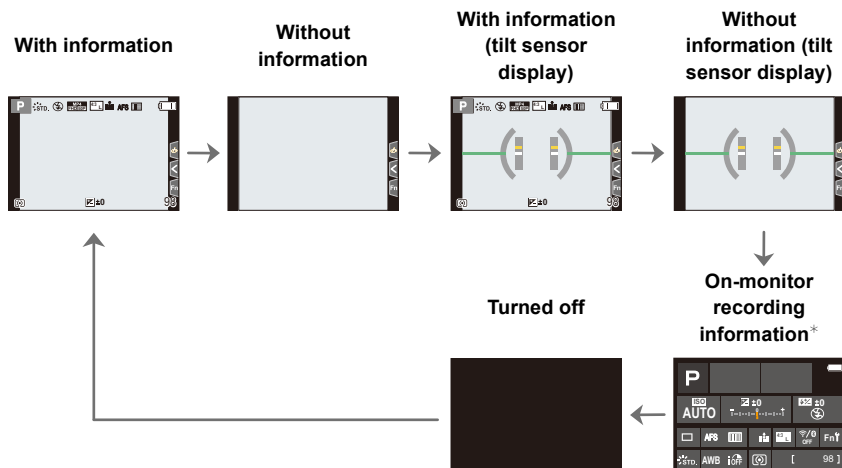

* It is displayed when [Monitor Info. Disp.] in the [Custom] ([Monitor / Display]) is set to [ON]. You can touch the desired item and change its setting directly.

About the tilt sensor display

With the tilt sensor displayed, it is easy to correct the tilt of the camera etc.

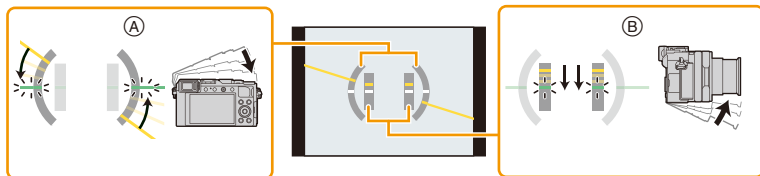

- (A) **Horizontal direction:** Correcting tilt to the left
 (B) **Vertical direction:** Correcting downward tilt

• When the camera is tilted very little or not at all, the level gauge will turn green.

• Even after correcting the tilt, there may still be an error of approximately $\pm 1^\circ$.

• When the camera is tilted significantly upwards or downwards to record, the tilt sensor may not work correctly.

In Playback Mode

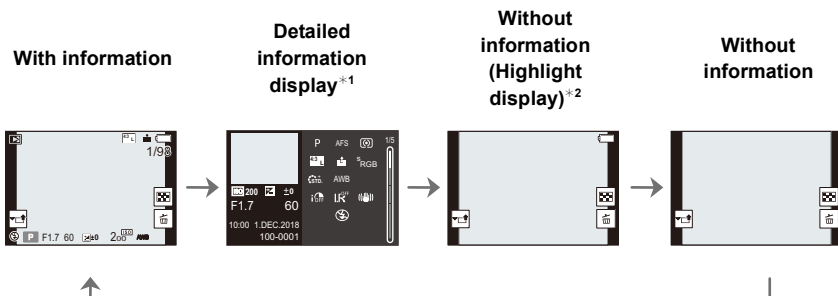

*1 Press $\blacktriangle/\blacktriangledown$ to switch between the following display modes:

- Detailed information display
- Histogram display
- Photo style, Highlight shadow display
- White balance display
- Lens information display

*2 This is displayed if [Highlight] in the [Custom] ([Monitor / Display]) menu is set to [ON].

Touch screen (Touch operations)

■ Touch

To touch and release the touch screen.

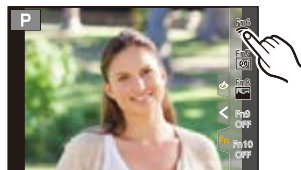

■ Drag

A movement without releasing the touch screen.

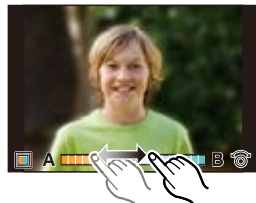

■ Pinch (enlarge/reduce)

On the touch screen, spread (pinch out) two fingers to zoom in and narrow (pinch in) them to zoom out.



- Touch the screen with the clean and dry finger.
- If you use a commercially available monitor protection sheet, please follow the instructions that accompany the sheet.
(Some monitor protection sheets may impair visibility or operability.)

Not available in these cases:

- The touch screen may not function normally in the following cases.
 - When touched by a gloved hand
 - When the touch screen is wet

Taking Pictures Using the Touch Function

Touch AF/Touch Shutter

Applicable modes:   P A S M



1 Touch .



2 Touch an icon.

- The icon switches every time you touch it.



 (Touch AF)	Focuses on the position you touch.*
 (Touch shutter)	Focuses on the touched position before recording takes place.*
 (OFF)	Touch AF and Touch Shutter are disabled.

- * When [Touch AF] in [Touch Settings] of the [Custom] ([Operation]) menu is set to [AF+AE], the focus and brightness are optimised for the touched position. (P86)

3 (When settings other than OFF are selected)
Touch the subject.

- When  (Touch AF) is set, refer to P82 for information about the operation to change the size and position of the AF area.



- If shooting with the touch shutter fails, the AF area turns red and disappears.

Touch AE

Applicable modes:   P A S M

You can easily optimise the brightness for a touched position. When the face of the subject appears dark, you can brighten the screen according to the brightness of the face.

1 Touch [].



2 Touch [].

- The setting screen for the brightness optimisation position is displayed.
- [Metering Mode] is set to [, which is used exclusively for the Touch AE.



3 Touch the subject you want to optimise the brightness for.

- Touch [Reset] to bring the brightness optimisation position back to the centre.



4 Touch [Set].

■ Cancelling the Touch AE function

Touch [].

Not available in these cases:

- This function is not available in the following cases:
 - When using the Digital Zoom
 - When [Touch AF] in [Touch Settings] of the [Custom] ([Operation]) menu has been set to [AF+AE]

Setting menu items

You can either operate the buttons or touch the monitor to set menu items.

1 Press [MENU/SET] to display the menu.



2 Press ◀.

3 Press ▲/▼ to select a menu selector icon, such as [📷].

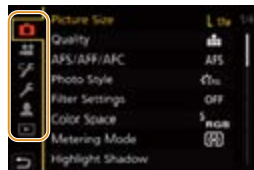

[Intelligent Auto] (P60)	This menu lets you set the functions that can only be used in Intelligent Auto Mode.
[Rec] (P171)	This menu lets you set picture settings.
[Motion Picture] (P184)	This menu lets you set motion picture settings.
[Custom] (P185)	Operation of the unit, such as displaying of the screen and button operations, can be set up according to your preferences.
[Setup] (P200)	This menu lets you perform the clock settings, select the operating beep tone settings and set other settings which make it easier for you to operate the camera. You can also configure the settings of Wi-Fi/Bluetooth related functions.
[My Menu] (P209)	This menu lets you register frequently-used menus.
[Playback] (P210)	This menu lets you set the playback and editing settings for images.

- The [Setup] menu contains some important settings relating to the camera's clock and power. Check the settings of this menu before proceeding to use the camera.

4 Press [MENU/SET].

Touch operation

Touch a menu selector icon, such as [📷].

- 5** Press ▲/▼ to select the menu item and press [MENU/SET].

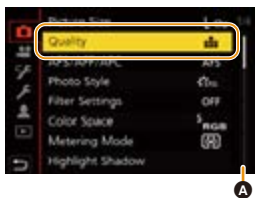

Touch operation

Touch the menu item.

- You can switch the page by touching the bar (A) on the right side of the screen.

- 6** Press ▲/▼ to select the setting and press [MENU/SET].

- Depending on the menu item, its setting may not appear or it may be displayed in a different way.

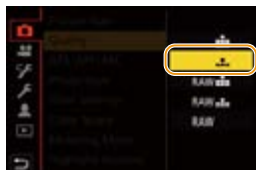

Touch operation

Touch the Setting to set.

- You can also rotate the control dial to select the menu selector icon, menu item, or setting.

Close the menu

Press [DISP.] or press the shutter button halfway.

Touch operation

Touch [DISP.].

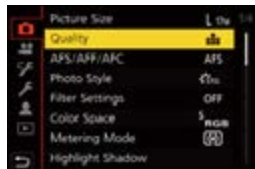

- Press [DISP.] to display the menu description.
- Menu items that are not available are displayed in grey. If you press [MENU/SET] while a grey item is selected, the reason why it cannot be set is displayed in some setting situations.

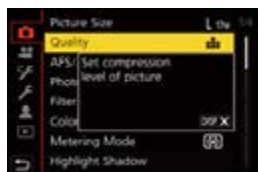

Calling frequently-used menus instantly (Quick Menu)

1 Press [Q.MENU] to display the Quick Menu.

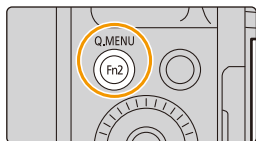

2 Turn the control dial to select the item, and press ▼ or ▲.

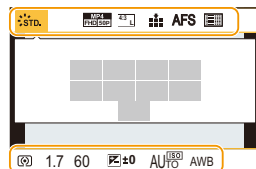

3 Rotate the control dial to select the setting.

4 Press [Q.MENU] to exit the Quick Menu once the setting is complete.

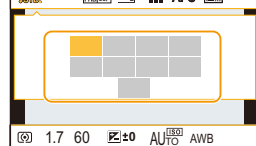

• You can also press ◀/▶ to select the item or setting.

• The features that can be adjusted using Quick Menu are determined by the mode or a display style the camera is in.

When using the on-monitor recording information screen (P41)

1 Press [Q.MENU].

2 Rotate the control dial to select the item and then press [MENU/SET].

3 Rotate the control dial to select the setting.

4 Press [Q.MENU] to finish.

• You can also set with ▲/▼/◀/▶ and [MENU/SET].

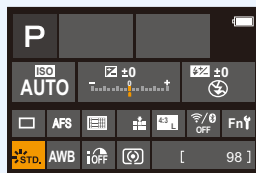

Customising the Quick Menu settings

You can add a maximum of 15 preferred settings to the Quick Menu.

1 Select the menu.

MENU → [Custom] → [Operation] → [Q.MENU] → [CUSTOM]

2 Press the shutter button halfway to close the menu.

3 Press [Q.MENU] to display the Quick Menu.

4 Press ▼ to select [] and then press [MENU/SET].

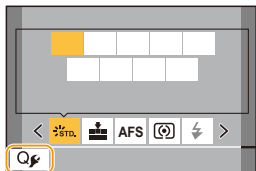

5 Press ▲/▼/◀/▶ to select the menu item in the top row and then press [MENU/SET].

- Items that have already been set in the top row are displayed in light grey.

6 Press ◀/▶ to select the empty space in the bottom row and then press [MENU/SET].

(A) Items that can be set

(B) Set items

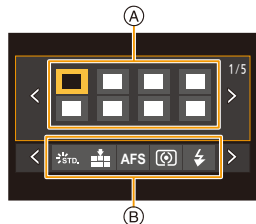

- You can also perform the same operation by dragging the item from the top row to the bottom row.

- If there is no empty space in the bottom row, you can replace an existing item with a new select item by selecting the existing item.

- You can follow the steps below to cancel the setting.

① Press ▼ to move to the bottom row.

② Press ◀/▶ to select the item to be cancelled and then press [MENU/SET].

7 Press [↵].

- It will return to screen of step 4.

Press [MENU/SET] to switch to the recording screen.

Assigning Frequently-Used Functions to Buttons (Function Buttons)

1 Select the menu.

MENU → [Custom] → [Operation] → [Fn Button Set] → [Setting in REC mode]/[Setting in PLAY mode]

2 Press ▲/▼ to select the function button you want to assign a function to and then press [MENU/SET].



3 Press ▲/▼ to select the function you want to assign and then press [MENU/SET].

- For details on the functions that can be assigned in [Setting in REC mode], refer to [P51](#).
- For details on the functions that can be assigned in [Setting in PLAY mode], refer to [P53](#).
- To restore the default function button settings, select [Restore to Default].

■ Setting function buttons from the on-monitor recording information screen

You can also display the screen in step 2 by touching [Fn] on the on-monitor recording information screen ([P41](#)).

■ Assigning functions quickly

You can display the screen in step 3 by pressing and holding a function button ([Fn1] to [Fn5]) (2 seconds).

- Some functions may not be available depending on the mode or the displayed screen.
- Some functions cannot be assigned depending on the function button.

Using the function buttons during recording

Press the function button to use the assigned function.

■ Using function buttons with touch operations

- 1 Touch .
- 2 Touch [Fn6], [Fn7], [Fn8], [Fn9] or [Fn10].



■ Functions that can be assigned in [Setting in REC mode]

– [4K Photo Mode] (P101)	– [Quality] (P173)	– [Sound Rec Level Adj.] (P162)
– [Post Focus] (P111)	– [AFS/AFF/AFC] (P75)	– [Utilize Custom Set feature] (P71)
– [Exposure Comp.] (P91)	– [Metering Mode] (P176)	– [Silent Mode] (P180)
– [Wi-Fi] (P228)	– [Bracket] (P130)	– [Peaking] (P193)
– [Q.MENU] (P48)	– [Highlight Shadow] (P177)	– [Histogram] (P193)
– [Video Record] (P156)	– [i.Dynamic] (P178)	– [Guide Line] (P194)
– [LVF/Monitor Switch] (P35)	– [i.Resolution] (P178)	– [Zebra Pattern] (P195)
– [LVF/Monitor Disp. Style] (P41)	– [Min. Shtr Speed] (P179)	– [Monochrome Live View] (P192)
– [AF/AE LOCK] (P90)	– [HDR] (P182)	– [Constant Preview] (P192)
– [AF-ON] (P90)	– [Shutter Type] (P181)	– [Live View Boost] (P192)
– [Preview] (P70)	– [Flash Mode] (P150)	– [Rec Area] (P196)
– [Touch AE] (P45)	– [Flash Adjust.] (P152)	– [Zoom lever] (P191)
– [Level Gauge] (P42)	– [Wireless Flash Setup] (P153)	– [Sensitivity] (P93)
– [Focus Area Set]	– [i.Zoom] (P143)	– [White Balance] (P95)
– [Operation Lock]	– [Digital Zoom] (P144)	– [AF Mode/MF] (P76)
– [Photo Style] (P174)	– [Stabilizer] (P140)	– [Drive Mode] (P98)
– [Filter Effect] (P123)	– [Motion Pic. Set] (P158)	– [Rec / Playback Switch]
– [Picture Size] (P172)	– [Picture Mode in Rec.] (P161)	– [Restore to Default]

• Function button settings at the time of purchase.

Fn1	[4K Photo Mode]	Fn6	[Wi-Fi]
Fn2	[Q.MENU]	Fn7	[Level Gauge]
Fn3	[Preview]	Fn8	[Histogram]
Fn4	[Post Focus]	Fn9	No function is set by default.
Fn5	[LVF/Monitor Switch]	Fn10	

- With [Video Record], you can start/stop recording a motion picture in the same way as with the motion picture button.
- When set to [Focus Area Set], it is possible to display the position setting screen of either AF area or MF Assist.
- When [Operation Lock] is set, a certain type of operation is disabled. Set the type of operation to be disabled in [Operation Lock Setting] in the [Custom] ([Operation]) menu. (P190)
- If you assign [Rec / Playback Switch], you can switch between recording and playback modes.
- If the screen displays **A** or similar, the displayed operation will be performed instead of the function assigned to function buttons by [Fn Button Set].



Using the function buttons during playback

You can use an assigned function by pressing the appropriate function button.

• Depending on the function, you can directly use it for the image being played back.

Example: When [Fn2] is set to [Rating★3]

- 1 Press ◀▶ to select the picture.
- 2 Press [Fn2], and then set the image as [Rating★3].



■ Functions that can be assigned in [Setting in PLAY mode]

• The following functions can be assigned to the button [Fn1], [Fn2], [Fn4] or [Fn5].

<ul style="list-style-type: none"> - [Wi-Fi] (P228) - [LVF/Monitor Switch] (P35) - [Rec / Playback Switch] - [4K PHOTO Play] - [Delete Single] (P170) - [Protect] (P213) - [Rating★1] (P213) - [Rating★2] (P213) 	<ul style="list-style-type: none"> - [Rating★3] (P213) - [Rating★4] (P213) - [Rating★5] (P213) - [RAW Processing] (P215) - [4K PHOTO Bulk Saving] (P217) - [Restore to Default]
--	---

• Function button settings at the time of purchase.

Fn1	[Wi-Fi]
Fn2	[Rating★3]

Fn4	No function is set by default.
Fn5	[LVF/Monitor Switch]

• If you assign [4K PHOTO Play], a screen will be displayed, allowing you to select the pictures to be extracted from a 4K burst file and saved.

Changing settings using the control ring

You can rotate the control ring to change settings.

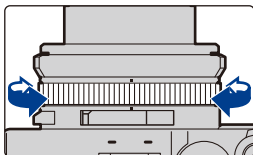

The functions that can be set with the control ring vary depending on the Recording Mode. Listed below are the default ([Normal]) settings.

Recording mode	Setting
iA Intelligent Auto Mode	Step Zoom (P145)
iA+ Intelligent Auto Plus Mode	
P Programme AE Mode	
A Aperture-Priority AE Mode	Shutter speed adjustment* (P65, 67)
S Shutter-Priority AE Mode	
M Manual Exposure Mode	

* You can set shutter speeds that are not indicated on the shutter speed dial. (P67)

- Rotating the control ring during panorama recording will change the selected image effect (filter). (P119)
- Rotating the control ring during Manual Focus will adjust the focus. (P88)
- The control ring can be used to change to your preferred settings. (P55)

Changing the function assigned to the control ring

1 Set the menu.

MENU →  **[Custom]** →  **[Operation]** → **[Control Ring]**

2 Use ▲/▼ to select the setting and press **[MENU/SET]**.

- You can assign the following functions:

– [Normal] (P54)	– [Photo Style] (P174)
– [Zoom] (P36)	– [Filter Effect] (P123)
– [Step Zoom] (P145)	– [Highlight Shadow] (P177)
– [Exposure Comp.] (P91)	– [i.Dynamic] (P178)
– [Sensitivity] (P93)	– [i.Resolution] (P178)
– [White Balance] (P95)	– [Flash Mode] (P150)
– [AF Mode] (P73)	– [Flash Adjust.] (P152)
– [Drive Mode] (P98)	

- To return to the default setting, select [Normal].
- If you do not use the control ring, select [OFF] ([Not Set]).

- The assigned function setting will be applied to all Recording Modes.
- Some functions may not be available depending on the mode or the displayed screen.

Entering Text

Follow the steps below when the text entry screen is displayed.

1 Press ▲/▼/◀/▶ to select text and then press [MENU/SET] to register.

- To enter the same character again, perform either of the following operations to move the cursor.
 - Rotate the control dial to the right.
 - Rotate the zoom lever to the [T] side.
- Operations when the items below are selected



- [A^a]: Switch text between [A] (upper case characters), [a] (lower case characters), [1] (numbers), and [&] (special characters)*¹
- []: Enter a blank
- [Delete]: Delete a character
- [◀]: Move the entry position cursor to the left⁺²
- [▶]: Move the entry position cursor to the right⁺²

*1 You can also switch between text modes by pressing [DISP].

*2 You can also move the entry position with the zoom lever or control dial.

- A maximum of 30 characters can be entered.
(Maximum of 9 characters when setting names in [Face Recog.]
- A maximum of 15 characters can be entered for [], [[], []], [•] and [—].
(Maximum of 6 characters when setting names in [Face Recog.]

2 Press ▲/▼/◀/▶ to select [Set], and then press [MENU/SET] to end the entry.

Taking Pictures using the Automatic Function (Intelligent Auto Mode)

Recording Mode:  

The camera chooses the optimal settings to match the subject and the recording conditions. We recommend this mode when you want to leave the settings to the camera and take pictures with ease.

1 Press [iA].

- The camera switches to Intelligent Auto Mode.
- When you press the [iA] again, the recording mode is switched to one that is set using the aperture ring and shutter speed dial.
- At the time of purchase, the mode is set to Intelligent Auto Plus Mode.

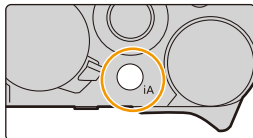

2 Hold the camera with the lens facing toward the subject.

- When the camera identifies the optimum scene, the icon of the scene concerned will change. (Automatic Scene Detection)



The camera detects scenes automatically (Scene Detection)

(📷: When taking pictures, 📹: When recording motion pictures)



[i-Portrait]



[i-Scenery]



[i-Macro]



[i-Night Portrait]*1



[i-Night Scenery]



[iHandheld Night Shot]*2



[i-Food]



[i-Baby]*3



[i-Sunset]



[i-Low Light]

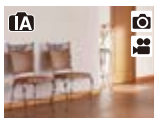

IA+

*1 Displayed when an external flash is used.

*2 Only displayed when [iHandheld Night Shot] is set to [ON].

*3 Displayed when persons under 3 years old registered in the camera with the Face Recognition function are detected.

• [IA+] is set if none of the scenes are applicable, and the standard settings are set.

• When recording is performed with the 4K Photo or Post Focus function, Scene Detection works in the same way as when motion picture is recorded.

■ Switching between Intelligent Auto Plus Mode and Intelligent Auto Mode

1 Select the menu.

MENU → IA IA+ [Intelligent Auto] → [Intelligent Auto Mode]



2 Press ▲/▼ to select [IA+] or [IA] and then press [MENU/SET].



It is also possible to display the selection screen by touching the Recording Mode icon in recording screen.







Intelligent Auto Plus Mode allows you to adjust the settings below while also using Intelligent Auto Mode for other settings.

	 Intelligent Auto Plus Mode	 Intelligent Auto Mode
Setting the brightness	○	—
Setting the colour tone	○	—
Defocus Control	○	—
Menus that can be set	Many	Few





■ Auto Focus, Face/Eye Detection, and Face Recognition

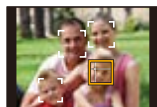



The Auto Focus Mode is automatically set to . If you touch the subject, the AF tracking function will work.

- The AF tracking function will also work if you press  and then press the shutter button halfway.
- When [Face Recog.] is set to [ON], and the face similar to the registered face is detected, [R] is displayed in the top right of , , and .



■ About the flash

When recording with the flash, the camera automatically selects , ,  or  according to the type and brightness of the subject.

- Refer to P147 for details about external flashes.
- When  or  is set, Red-Eye Removal is enabled.
- Shutter speed will be slower during  or .

■ Scene Detection

- Use a tripod or similar support when the scene detection has been identified as . When the camera has judged that camera shake is minimal, the shutter speed becomes slower than normal. Take care not to move the camera while taking pictures.
- Depending on recording conditions, different scene types may be selected for the same subject.



The Backlight Compensation

When there is a backlight, the subject appears darker and the camera will automatically attempt to correct it by increasing the brightness of the picture.

Backlight Compensation works automatically in Intelligent Auto Plus Mode or Intelligent Auto Mode.

[Intelligent Auto] menu

Taking handheld shots of night scenes ([iHandheld Night Shot])

When [iA] is detected while taking handheld night shots, pictures of the night scenery will be taken at a high burst speed and composed into a single picture.

MENU → **[iA]** **[iA]** **[Intelligent Auto]** → **[iHandheld Night Shot]** → **[ON]/[OFF]**

- The angle of view will be slightly narrower.
- Do not move the camera during the continuous shooting after pressing the shutter button.
- Flash is fixed to [S] ([Forced Flash Off]).

Combining pictures into a single picture with rich gradation ([iHDR])

When there is, for example, strong contrast between the background and the subject, multiple still pictures are recorded with differing exposures and combined to create a single still picture rich in gradation.

[iHDR] works automatically as needed. When it does, [HDR] is displayed on the screen.

MENU → **[iA]** **[iA]** **[Intelligent Auto]** → **[iHDR]** → **[ON]/[OFF]**

- The angle of view will be slightly narrower.
- Do not move the camera during the continuous shooting after pressing the shutter button.
- You cannot take the next picture until the combination of pictures is complete.
- A moving subject may be recorded with unnatural blurs.



Not available in these cases:

- [iHandheld Night Shot]/[iHDR] do not work for the pictures taken during a motion picture recording.
- [iHandheld Night Shot]/[iHDR] are not available in the following cases:
 - When recording in Burst Mode
 - When recording 4K photos
 - When recording with the Post Focus function
 - When recording with the Bracket function
 - When [Quality] is set to [RAW], [RAW] or [RAW]
 - When using [Time Lapse Shot]
 - When using [Stop Motion Animation] (only when [Auto Shooting] is set)
- [iHDR] is not available in the following case:
 - When recording using the flash

Taking pictures with customised colour, defocus control, and brightness settings

Recording Mode: 

■ Setting colour

- 1 Press [WB] (▶).
- 2 Rotate the control dial to adjust colour.
 - To return to the recording screen, press [MENU/SET].
 - The colour setting will return to the default level (centre point) when this unit is turned off or the camera is switched to another Recording Mode.



■ Taking a picture with a blurred background (Defocus Control)

- 1 Press [Fn3] to display the setting screen.
- 2 Set the blurriness by rotating the control dial.
 - To return to the recording screen, press [MENU/SET].
 - To cancel the setting, press [Fn3].
 - Auto Focus Mode is set to .





The position of the AF area can be set by touching the screen. (Its size cannot be changed)



■ Setting brightness

- You can rotate the exposure compensation dial to set the brightness. (P91)

Change the settings by using the touch screen

- 1 Touch .
- 2 Touch the item you want to set.
 - []: Colour tone
 - []: Defocus control
 - []: Brightness*

* It is displayed when [Exposure Comp.] is set in a function button. (P50)
- 3 Drag the slide bar to set.
 - To return to the recording screen, press [MENU/SET].



Taking Pictures with Automatically Adjusted Aperture and Shutter Speed (Programme AE Mode)

Recording Mode: **[P]**

The camera automatically sets the shutter speed and the aperture value according to the brightness of the subject.

You can take pictures with greater freedom by changing various settings in the [Rec] menu.

1 Turn the aperture ring to select **[A]** (AUTO).

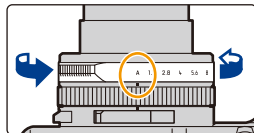

2 Turn the shutter speed dial to select **[A]** (AUTO).

- Programme AE Mode is set and the recording mode icon changes to [P].

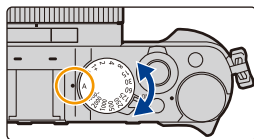

3 Press the shutter button halfway and display the aperture value and shutter speed value on the screen.

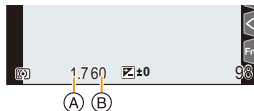

- (A) Aperture value
- (B) Shutter speed

- If the exposure is not adequate, the aperture value and shutter speed turn red and blink.

4 While the numeric values are displayed (approximately 10 seconds), turn the control dial to change the values using Programme Shift.

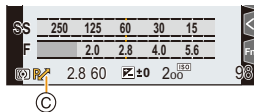

- (C) Programme Shift indication

- To cancel Programme Shift, perform either of the following operations:
 - Set the camera on/off switch to [OFF].
 - Rotate the control dial until the Programme Shift indication disappears.
- When compensating the exposure, adjust it with the exposure compensation dial. (P91)

■ Programme Shift

You can change the preset aperture value and shutter speed without changing the exposure. This is called Programme Shift.

It enables you to, for example, make the background more defocused by decreasing the aperture value or capture a moving subject more dynamically by slowing the shutter speed.

Not available in these cases:

- Programme Shift is not available in the following cases:
 - When recording using the flash
 - When recording 4K photos
 - When recording with the Post Focus function
 - When the ISO sensitivity is set to [ISO]



MENU



Taking Pictures by Specifying the Aperture/ Shutter Speed



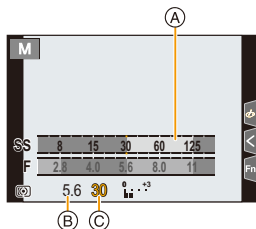

Recording Mode: **A S M**

You can set the exposure using the aperture ring and shutter speed dial settings.

(Example: In Manual Exposure Mode)



- (A) Exposure metre
- (B) Aperture value
- (C) Shutter speed

Aperture value	 <p>Small It becomes easier to defocus the background.</p>	 <p>Large It becomes easier to maintain focus as far as the background.</p>
Shutter speed	 <p>Slow It becomes easier to express movement.</p>	 <p>Fast It becomes easier to freeze movement.</p>

- The effects of the set aperture value and shutter speed will not be visible on the recording screen. To check on the recording screen, please use [Preview]. (P70)
- The brightness of the screen and the recorded pictures may differ. Check the pictures on the playback screen.
- When you turn the aperture ring or shutter speed dial, an exposure metre is displayed. Unsuitable areas of the range are displayed in red.
- If the exposure is not adequate, the aperture value and the shutter speed turn red and blink when the shutter button is pressed halfway.
- A faster shutter speed than the set shutter speed may be used when you record a motion picture.

Aperture-Priority AE Mode

When you set the aperture value, the camera automatically optimises the shutter speed for the brightness of the subject.

1 Turn the shutter speed dial to select [A] (AUTO).

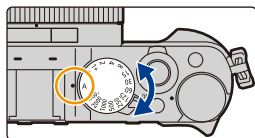

2 Turn the aperture ring to select the aperture value.

- Aperture-Priority AE Mode is set and the recording mode icon changes to [A].
- When compensating the exposure, adjust it with the exposure compensation dial. (P91)

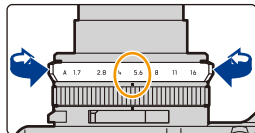

Available aperture values*	Shutter speed set (sec.)
F1.7 to F16	60 to 1/4000 (When the mechanical shutter is used) 1 to 1/16000 (When the electronic shutter is used)

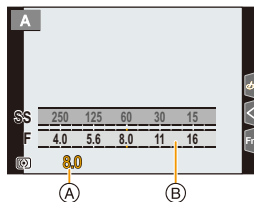

- (A) Aperture value
- (B) Exposure metre

* You may not be able to select some values depending on zoom position.

Shutter-Priority AE Mode

When you set the shutter speed, the camera automatically optimises the aperture value for the brightness of the subject.

1 Turn the aperture ring to select [A] (AUTO).

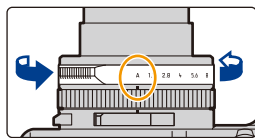

2 Turn the shutter speed dial to select the shutter speed.

- Shutter-Priority AE Mode is set and the recording mode icon changes to [S].
- When compensating the exposure, adjust it with the exposure compensation dial. (P91)

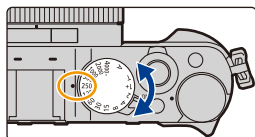

Available Shutter Speed (Sec.)	Aperture value set
60 to 1/4000 (When the mechanical shutter is used)	F1.7 to F16
1 to 1/16000 (When the electronic shutter is used)	

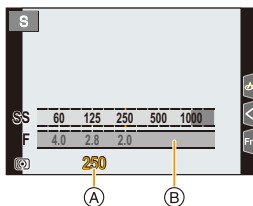

- (A) Shutter speed
(B) Exposure metre

Manual Exposure Mode

Determine the exposure by manually setting the aperture value and the shutter speed.

1 Turn the aperture ring to select the aperture value.

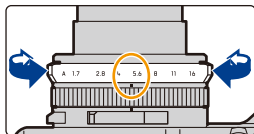

2 Turn the shutter speed dial to select the shutter speed.

- Manual Exposure Mode is set and the recording mode icon changes to [M].

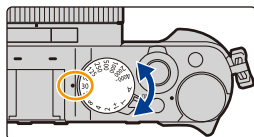

Available aperture values ^{*1}	Shutter speed set (sec.) ^{*2}
F1.7 to F16	[T] (Time) 60 to 1/4000 (When the mechanical shutter is used) 1 to 1/16000 (When the electronic shutter is used)

*1 You may not be able to select some values depending on zoom position.

*2 You may not be able to select some shutter speeds depending on the aperture value.



- (A) Exposure metre
- (B) Aperture value
- (C) Shutter speed
- (D) Manual Exposure Assistance



Setting the shutter speed to values not provided on the shutter speed dial

Turn the control ring or control dial to set the following shutter speeds. Check the shutter speed on the screen.

The available shutter speeds vary depending on the [Shutter Type] setting. Refer to [P181](#) for information on how to change the setting.

Higher shutter speed than 1/4000 seconds or slower shutter speed than 1 second

- 1 Set the [Shutter Type] in the [Rec] menu ([P181](#))
- 2 Turn the shutter speed dial to select [4000-] or [1+]
- 3 Turn the control ring or control dial to select the shutter speed

Shutter speed setting in 1/3 EV steps

- You can set the shutter speed from the setting value of the shutter speed dial in the range of $\pm 2/3$ steps.

Example: To set the shutter speed to 1/400 seconds

- Turn the shutter speed dial to select [500]
- Turn the control ring or control dial to select [400]

**Optimising the ISO sensitivity for the shutter speed and aperture value**

When the ISO sensitivity is set to [AUTO], the camera sets the ISO sensitivity automatically so that the exposure will be appropriate for the shutter speed and aperture value.

- Depending on recording conditions, an appropriate exposure may not be set or the ISO sensitivity may become higher.

**Manual Exposure Assistance**

	The exposure is adequate.
	Set to faster shutter speed or larger aperture value.
	Set to slower shutter speed or smaller aperture value.

- The Manual Exposure Assistance is an approximation. We recommend checking the pictures on the playback screen.

■ About [T] (Time)

If you set the shutter speed to [T] (Time), the shutter stays open while the shutter button is pressed fully (up to approximately 30 minutes).

The shutter will close when the shutter button is pressed again.

Use this when you want to keep the shutter open for a long time to take pictures of fireworks, a night scene etc.

- It can only be used with Manual Exposure Mode.



- When the shutter speed is set to [T] (Time), we recommend using a tripod and taking pictures remotely by connecting the camera to a smartphone via Wi-Fi connection to prevent camera shake. [B] (Bulb) is also available when connected via Bluetooth. (P238, 240)

- When you take still pictures with the shutter speed set to [T] (Time), the pictures may have higher noise levels. If you want to suppress noise, we recommend taking pictures by setting [Long Shtr NR] to [ON] in the [Rec] menu. (P179)



Not available in these cases:

- This function is not available in the following cases:
 - When recording using the flash (only when [Flash Synchro] is set to [2ND])
 - When recording 4K photos
 - When recording with the Post Focus function
 - When recording with the Bracket function
 - When [Silent Mode] is set to [ON]
 - When using the electronic shutter
 - When [HDR] is set to [ON]
 - When using [Time Lapse Shot]
 - When using [Stop Motion Animation] (only when [Auto Shooting] is set)

Confirm the Effects of Aperture and Shutter Speed (Preview Mode)

Applicable modes: **[Fn] [Fn] [P] [A] [S] [M]**

- **Confirm the effects of aperture:** You can check the depth of field (effective focus range) before taking a picture by closing the diaphragm blades to the aperture value you set.
- **Confirm the effects of shutter speed:** Movement can be confirmed by displaying the actual picture that will be taken with that shutter speed.

Press **[Fn3]** to switch between different preview screens.

- [Preview] is assigned to [Fn3] by default. (P50)

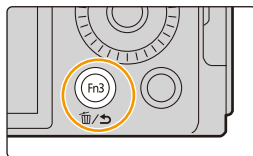

Normal recording screen



Aperture effect preview screen
Aperture effect: ON
Shutter speed effect: OFF



Shutter speed effect preview screen
Aperture effect: ON
Shutter speed effect: ON



Depth of field properties

	Aperture value	Small	Large
*1	Focal length	Tele	Wide
	Distance to the subject	Near	Distant
	Depth of field (effective focus range)	Shallow (Narrow)*2	Deep (Wide)*3

*1 Recording conditions

*2 Example: When you want to take a picture with a blurred background etc.

*3 Example: When you want to take a picture with everything in focus including the background etc.

• It is possible to record while in Preview Mode.

• Range for shutter speed effect check is 8 seconds to 1/16000 seconds.



Not available in these cases:

• Preview Mode is not available when recording with [4K Pre-Burst].

Registering your preferred settings (Custom Set)

Applicable modes:   **P** **A** **S** **M**

Registering Personal Menu Settings (Registering custom settings)

You can register up to 3 combinations of your preferred menu settings.

Preparations:

Change the settings of menus such as [Rec] menu, [Motion Picture] menu, and [Custom] menu to your preferred settings.

MENU →  [Setup] → [Cust.Set Mem.] →

Custom set where you want to register settings

- The following menu items are not registered as custom settings.

[Custom] menu	[Setup] menu
<ul style="list-style-type: none"> - Data registered with [Face Recog.] - The [Profile Setup] setting 	[Playback] menu
	<ul style="list-style-type: none"> - [Rotate Disp.] - [Picture Sort] - [Delete Confirmation]

Calling up a registered set of custom settings

1 Select the menu.

MENU →  [Setup] → [Utilize Custom Set feature]

2 Press ▲/▼ to select the custom setting you want to use, and then press [MENU/SET].

- The settings are switched to those settings you selected for the custom set.



You can also display the selection screen by touching the recording mode icon on the recording screen.



■ Changing registered settings

Even if the menu settings are changed temporarily while any one of the custom settings is selected, the currently registered settings will remain unchanged.

To change the currently registered settings, overwrite the registered data using [Cust.Set Mem.] on the [Setup] menu.



Quickly calling up custom sets

Setting the function button to [Utilize Custom Set feature] allows you to switch quickly to your preferred settings by pressing the function button.

- 1 Use [Fn Button Set] in the [Custom] ([Operation]) menu to set the [Utilize Custom Set feature] in the desired function button. (P50)
 - 2 Press function button.
 - 3 Use ◀/▶ to select custom set and press [MENU/SET].
-



MENU



4.

Focus, Brightness (Exposure) and Colour tone Settings

Adjusting Focus Automatically

Applicable modes: **[A]** **[AF]** **[P]** **[A]** **[S]** **[M]**

1 Switch the focus selector switch to [AF] or [AF].

- The Focus Mode will be set. (P75)

(A): Align with the indicator

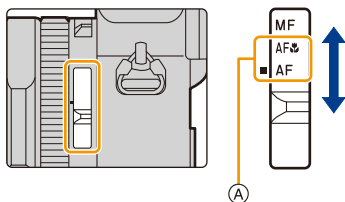

2 Press [] (◀).

3 Press ◀▶ to select AF Mode and then press [MENU/SET].

- The Auto Focus Mode will be set. (P76)

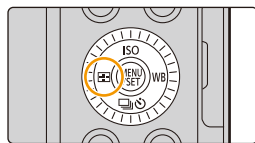

4 Press the shutter button halfway.

- Auto Focus will be activated.

Focus	When the subject is focused	When the subject is not focused
Focus indication (B)	On	Blinks
AF area (C)	Green	—
Sound	Beeps 2 times	Beeps 4 times

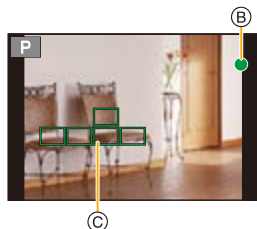

- The focus indication is displayed as [LOW] in a dark environment, and focusing may take longer than usual.
- If the camera detects stars in the night sky after displaying [LOW], Starlight AF will be activated. When focus is achieved, the focus indication [STAR] and AF areas in focus are displayed. (Starlight AF cannot perform detection on the edges of the screen.)

- In Intelligent Auto Mode, the camera performs the same operation as [AF] even if you set the focus selector switch to [AF \uparrow] (AF Macro).
- If you zoom in/out after focusing on a subject, the focus may lose its accuracy. In that case, re-adjust the focus.
- When the lighting is low making it difficult to focus with Auto Focus, set [Monitor Display Speed] or [LVF Display Speed] to [60fps].



Subjects and recording conditions which are difficult to focus

- Fast-moving subjects, extremely bright subjects or subjects without contrast.
- When recording subjects through windows or near shiny objects.
- When it is dark or when jitter occurs.
- When the camera is too close to the subject or when taking a picture of both distant and near subjects.



How to adjust the composition while pressing the shutter button halfway

When recording with [■], follow the steps below if the subject is not in the centre of the composition of the picture you want to take. (When [AFS/AFF/AFC] is set to [AFS])

- 1 Aim the AF area over the subject.
- 2 Press the shutter button halfway.
 - This will lock the focus and exposure.
- 3 While continuing to press and hold the shutter button halfway, move the camera to compose the picture you want to take.
- 4 Press the shutter button to take the picture.

Setting the Focus Mode (AFS/AFF/AFC)

Applicable modes: **[A]** **[AF]** **[P]** **[A]** **[S]** **[M]**

The method for achieving focus when the shutter button is pressed halfway is set.

Preparation:

Set the focus selector switch to [AF] or [AF $\frac{1}{2}$].

[MENU] → **[Rec]/** **[Motion Picture]** → **[AFS/AFF/AFC]**

(A): Align with the indicator

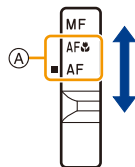

Item	Recommended recording scenes	
[AFS]	Subject is still (Scenery, anniversary photograph, etc.)	"AFS" is an abbreviation of "Auto Focus Single". The focus stays locked while the shutter button is pressed halfway, so you can perform recording while changing the composition.
[AFF]	Movement cannot be predicted (Children, pets, etc.)	"AFF" is an abbreviation of "Auto Focus Flexible". If the subject moves while the shutter button is pressed halfway, the focus is readjusted automatically according to the movement of the subject.
[AFC]	Subject is moving (Sport, trains, etc.)	"AFC" is an abbreviation of "Auto Focus Continuous". In this mode, while the shutter button is pressed halfway, focusing is constantly performed to match the movement of the subject.



When recording using [AFF], [AFC]

- When the subject is moving, the focusing is performed by predicting the subject position at the time of recording. (Movement prediction)
 - It may take time to focus on the subject when you operate the zoom from Wide to Tele or suddenly change the subject from a distant one to a nearby one.
 - Press the shutter button halfway again when it is difficult to focus on the subject.
 - While the shutter button is pressed and held halfway, shake may be seen on the screen.
-
- In the following cases, [AFF] or [AFC] operates in the same way as [AFS]:
 - When recording with [4K Burst(S/S)]
 - In low light situations
 - It is fixed to [AFS] when Panorama Shot Mode is set.
 - [AFF] is not available when recording 4K photos. [Continuous AF] works during recording.
 - The Focus Mode setting cannot be changed when recording is performed with the Post Focus function.

Setting the Auto Focus Mode

Applicable modes: **[A] [Av] [P] [A] [S] [M]**

This allows the focusing method that suits the positions and number of the subjects to be selected.

Press **[]** (**◀**).

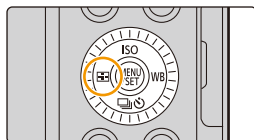



**([Face/Eye
 Detection])**

The camera automatically detects the faces and eyes of subjects. The camera adjusts the focus on the eye that is closer to the camera and the exposure using the face (when [Metering Mode] is set to []). (P77)



([Tracking])

The camera keeps adjusting the focus and exposure automatically to the specified moving object. (Dynamic Tracking)
 (When [Metering Mode] is set to []) (P78)



([49-Area])

Up to 49 AF areas can be focused.
 This is effective when a subject is not in the centre of the screen.



([Custom Multi])

From among 49 AF areas, you can freely set the optimum shape of the AF area for the subject. (P79)





([1-Area])

The camera focuses on the subject in the AF area on the screen.



([Pinpoint])

You can achieve a more precise focus on a point that is smaller than [].
 If you press the shutter button halfway, the screen that lets you check the focus will be enlarged.



• In Intelligent Auto Mode and Intelligent Auto Plus Mode, you can switch to either [] or [].

About [Face/Eye Detection]

When the camera detects faces, AF areas are displayed and the eye to be brought into focus are indicated.

(A): Eye used for focusing

Yellow: The colour changes to green when the shutter button is pressed halfway and focus is achieved.

White: This is displayed when more than one face is detected. Faces that are at the same distance as the face inside the yellow AF area will be brought into focus.

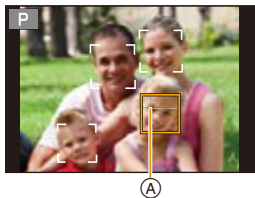

- The camera can detect the faces of up to 15 people.
Only the eyes of the face to be brought into focus can be detected.

Changing the eye to be brought into focus

Touch the eye to be brought into focus.

- Touching [AF] or pressing [MENU/SET] will cancel the setting of the eye that has been brought into focus.



Locking the subject to be tracked ([AF-LOCK] ([Tracking]))

Button operation

Aim the AF Tracking area (B) over the subject and then press the shutter button halfway.

- The AF area turns green when the subject is detected.
- The AF area turns yellow when you release the shutter button.
- Press [MENU/SET] to clear the lock.

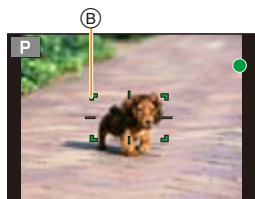

Touch operation

Touch the subject.

- Perform this operation with the Touch Shutter function cancelled.
- The AF Tracking area turns yellow while the subject is locked.
- Touch [AF OFF] to clear the lock.



- The focus range will be the same as that of [AF] (AF Macro). (P87)
- The AF Tracking area will blink in red and then disappear if the lock fails.

Setting the shape of the AF area ([Custom Multi])

- 1 Press [] (◀).
- 2 Select a Custom Multi icon ([], etc.), and press ▲.
- 3 Press ◀/▶ to select a setting and then press ▼.

(A) The current shape of the AF area

<p>([Horizontal Pattern])</p>	<p>This shape is convenient for taking panning shots or similar shots.</p>	
<p>([Vertical Pattern])</p>	<p>This shape is convenient for recording objects, such as buildings.</p>	
<p>([Central Pattern])</p>	<p>This shape is convenient when you want to bring the centre area into focus.</p>	
<p>([Custom1]/[Custom2]/[Custom3])</p>	<p>You can select a customised setting.</p>	

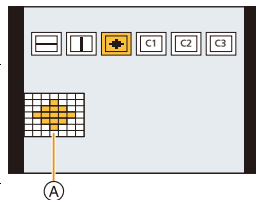

- The AF area setting screen is displayed.

4 Select AF areas.

(B) The selected AF areas

When selecting []/[]/[]

- 1 Change the shape of an AF area.

Button operation	Touch operation	Description of operation
▲/▼/◀/▶	Touching	Moves the position
	Pinching out/in	Changes the size
[DISP.]	[Reset]	First time: The position is reset to the centre Second time: The size is reset to the default

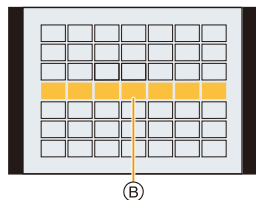

- 2 Press [MENU/SET] to set.

When selecting [C1]/[C2]/[C3]

- ❶ Change the shape of an AF area.

Button operation

Press ▲/▼/◀/▶ to select the AF area, and then press [MENU/SET] to set (repeat).

- The setting is cancelled when [MENU/SET] is pressed again.
- To cancel all selections, press [DISP].

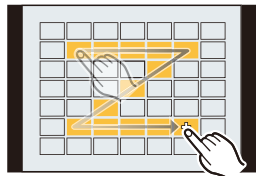

Touch operation

Touch or drag to select AF areas.

- To cancel the selection of a particular AF area, touch the area again.

- ❷ Press [Fn2] to set.

■ **Registering the set AF area to** [C1], [C2] or [C3]

- ❶ On the screen in step 3 on P79, press ▲.



- ❷ Press ▲/▼ to select a destination to which the setting will be registered, and press [MENU/SET].

- Turning off this unit will return the setting adjusted with [.....]/[]/[⊕] back to the default setting.

Restrictions on Auto Focus Mode

- It cannot be set the Auto Focus Mode in the following case.
 - When recording with the Post Focus function
- The AF Mode is fixed to [■] in the following cases.
 - When using the Digital Zoom
 - When using [Miniature Effect] in [Filter Settings]
-  ([Face/Eye Detection])
 - The camera may not detect faces in certain situations, such as when the subjects are moving fast. In such situations, the camera performs the operation of [■].



([Tracking])

- In situations where AF Tracking does not work correctly due to certain recording conditions, such as when the subject is small or the location is dark, the operation of [■] is performed.
- [] cannot be used with [Time Lapse Shot].
- In the following cases, [] operates as [■].
 - When using [Sepia]/[Monochrome]/[Dynamic Monochrome]/[Rough Monochrome]/[Silky Monochrome]/[Soft Focus]/[Star Filter]/[Sunshine] in [Filter Settings]
 - When using [Monochrome]/[L.Monochrome]/[L.Monochrome D] in [Photo Style]

([Custom Multi])

- AF areas at the centre are brought into focus during 4K photo recording or motion picture recording using [Continuous AF].

([Pinpoint])

- In the following cases, [] operates as [■].
 - When recording motion pictures
 - When recording 4K photos
- It cannot be set to [] in the following case.
 - When [AFS/AFF/AFC] in the [Rec] menu is set to [AFF]/[AFC]

Changing the position and size of the AF area

Applicable modes: P A S M

When [], [], [] or [] in Auto Focus Mode is selected, you can change the position and size of the AF area. With [], you can set the lock-on position.

- Perform these operations with the touch shutter function released.
- You can also display the AF area setting screen by touching the recording screen.

MENU → **[Custom]** → **[Operation]** → **[Touch Settings]** → **[Touch AF]** → **[AF]**

- You can use the [Custom] ([Focus / Release Shutter]) menu to set the display method for the AF area according to your preference. (P185)
- The spot metering target can also be moved to match the AF area when the [Metering Mode] is set to [].

Not available in these cases:

- This function is not available in the following case:
 - When using the Digital Zoom

When selecting [], [], []

- 1 Press [] (◀).
- 2 Select [], [] or [] and press ▼.
 - The AF area setting screen appears.



3 Change the position and size of the AF area.

Button operation	Touch operation	Description of operation
▲/▼/◀/▶	Touching	Moves the position
–	Pinching out/in	Changes the size (in small steps)*
	–	Changes the size*
[DISP.]	[Reset]	First time: The position is reset to the centre Second time: The size is reset to the default*

* This operation is not available for [].

4 Press **[MENU/SET]** to set.

- If you have selected [], an AF area with the same function as [] will be set in the set position.
Setting of the AF area is cleared when [MENU/SET] is pressed or [] is touched.

When selecting [AF]

You can set the focus position by selecting an AF area group. The AF area, which is configured with 49 points, is divided into groups consisting of 9 points each (6 points or 4 points for the groups located at the edges of the screen).

- 1 Press [AF] (◀).
- 2 Select [AF] and press ▼.
 - The AF area setting screen appears.
- 3 Press ▲/▼/◀/▶ to select an AF area group.
- 4 Press [MENU/SET] to set.
 - Setting of the AF area is cleared when [MENU/SET] is pressed or [AF OFF] is touched.

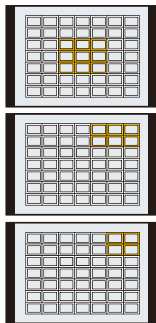

Examples of group

When selecting [+]



You can set the focus position precisely by enlarging the screen.

- 1 Press [] (◀).
- 2 Select [+] and press ▼.
- 3 Press ▲/▼/◀/▶ to set the focus position and then press [MENU/SET].

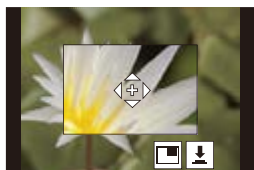
- The enlarged display appears.



- 4 Move [+] to the position to be in focus.

Button operation	Touch operation	Description of operation
▲/▼/◀/▶	Touching	Moves [+].
—	Pinching out/in	Enlarges/reduces the screen in small steps.
	—	Enlarges/reduces the screen.
—		Switches the enlarged display (windowed/full screen). 
[DISP.]	[Reset]	Returns you to the screen in step 3.

- When the picture is displayed in windowed mode, you can enlarge the picture by approximately 3× to 6×; when the picture is displayed in full screen, you can enlarge the picture by approximately 3× to 10×.
- You can also take pictures by touching [].

- 5 Press [MENU/SET] to set.

- You cannot set the position to be in focus at the edges of the screen.

Specifying the AF area position with the Touch Pad

Applicable modes:

You can move the AF area displayed on the viewfinder by touching the monitor.

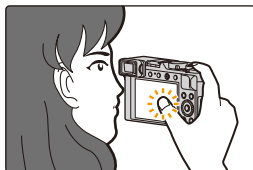

MENU → **[Custom]** → **[Operation]** → **[Touch Settings]** → **[Touch Pad AF]**

[EXACT]	Moves the AF area of the viewfinder by touching a desired position on the touch pad.	
[OFFSET]	Moves the AF area of the viewfinder according to the distance you drag the touch pad.	
[OFF]	—	—

- Press the shutter button halfway to determine the focus position.
To return the focus position to the centre, press [DISP.] before determining the position.
- To cancel the AF area setting when , or is selected, press [MENU/SET].

Specifying the AF area position with the Touch Function

Applicable modes:

MENU → [Custom] → [Operation] → [Touch Settings] → [Touch AF] → [AF+AE]

1 Touch the subject you want to optimise the brightness for.

- The AF area setting screen appears. (P82)
- The brightness optimisation position is displayed on the centre of the AF area. The position follows the movement of the AF area.
- [Metering Mode] is set to , which is used exclusively for the Touch AE.



2 Touch [Set].

- The touched position will be set as an AF area with the same function as .
- To cancel the focus and brightness set with [AF+AE], touch () when is selected).



When the background has become too bright, etc., the brightness contrast with the background can be adjusted by compensating the exposure.



- When recording with the Touch Shutter, the focus and brightness are optimised for the touched position before recording takes place.
- At the edge of the screen, the metering may be affected by the brightness around the touched location.



Not available in these cases:

- The [AF+AE] does not function in the following case:
 - When using the Digital Zoom

Taking Close-up Pictures

Applicable modes: **[A]** **[AF]** **[P]** **[A]** **[S]** **[M]**

This mode allows you to take close-up pictures of a subject, e.g. when taking pictures of flowers.

Switch the focus selector switch to **[AF]**.

- You can take pictures of a subject as close as 3 cm (0.098 feet) from the lens by rotating the zoom lever upmost to Wide.
- The focus range is displayed when you operate the zoom, for example. (P37)

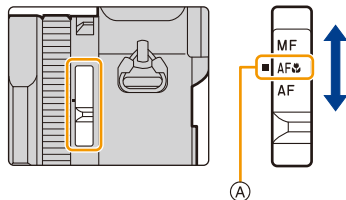

(A) Align with the indicator

- In Intelligent Auto Mode, the shortest recording distance will be the same as that for **[AF]**, regardless of the focus selector switch setting.
- Keep the following points in mind when taking close-up pictures:
 - A picture may be out of focus when the subject is out of focus range, even if the focus display is lit.
 - Using a tripod and [Self Timer] is recommended.
 - We recommend not using the flash.
 - The effective focus range is significantly narrowed. Therefore, if the distance between the camera and the subject is changed after focusing on the subject, it may become difficult to focus on it again.
 - Resolution may be slightly reduced around the edges of the picture. This is not a malfunction.

Adjusting Focus Manually

Applicable modes: **[A]** **[Av]** **[P]** **[A]** **[S]** **[M]**

Use this function when you want to fix the focus or when the distance between the lens and the subject is determined and you do not want to activate Auto Focus.

1 Switch the focus selector switch to [MF].

- (A) Align with the indicator

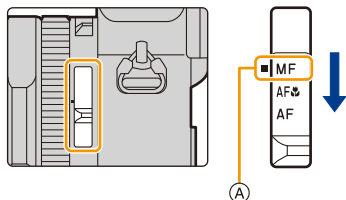

2 Press [MF/AF] (◀).

3 Press ▲/▼/◀/▶ to adjust the focus position, and press [MENU/SET].

- The assist screen is displayed, enlarging the area. (MF Assist)
- You can also adjust the focus position by dragging the screen.
- You can also enlarge the display by pinching out or touching the screen twice.

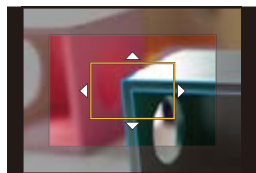

4 Turn the control ring to adjust focus.

Clockwise:

Focusing on a nearby subject

Counter-clockwise:



Focusing on a distant subject

- (B) MF Assist (enlarged screen)
- (C) Peaking
- (D) MF Guide

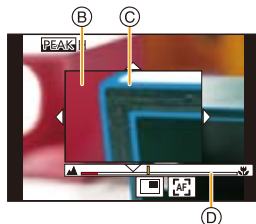
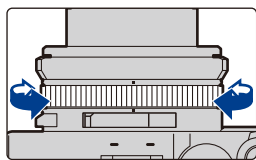
- In-focus portions are highlighted with colour. ([Peaking])
- You can check whether the point of focus is to the near side or to the far side. (MF Guide)



You can perform the following operations:

Button operation	Touch operation	Description of operation
▲/▼/◀/▶	Dragging	Moves the enlarged area.
—	Pinching out/in	Enlarges/reduces the screen in small steps.
	—	Enlarges/reduces the screen.
—		Switches the enlarged display (windowed/full screen). 
[DISP.]	[Reset]	The position of the enlarged area is reset to the centre.

* It cannot be set in Intelligent Auto Mode.

- When the picture is displayed in windowed mode, you can enlarge the picture by approximately 3× to 6×; when the picture is displayed in full screen, you can enlarge the picture by approximately 3× to 20×.

5 Press the shutter button halfway.

- The recording screen will be displayed.
- You can also perform the same operation by pressing [MENU/SET].

- When [Focus Switching for Vert / Hor] in the [Custom] ([Focus / Release Shutter]) menu is enabled, you can set the position of the enlarged MF Assist display for each orientation of the camera.



Achieving focus quickly using Auto Focus

In Manual Focus, the focus can be set on the subject through Auto Focus.

Touch .

- Auto Focus works at the centre of the frame.
- Auto Focus also works with the following operations.
 - Pressing the [AF/AE LOCK] to which [AF-ON] is assigned (P90)
 - Pressing the function button to which [AF-ON] is assigned (P50)
 - Dragging the monitor and releasing your finger at the position you want to focus on

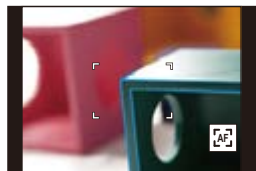

Fixing the Focus and the Exposure (AF/AE Lock)

Applicable modes:  P A S M

Lock the focus and exposure in advance to take pictures with the same focus and exposure settings while changing the composition.

This is useful when you want to bring an edge of the screen into focus or there is a backlight, for example.

1 Point the camera at the subject.

2 Press and hold [AF/AE LOCK] to fix the focus or exposure.

- If you release [AF/AE LOCK], AF/AE Lock is cancelled.

3 While pressing [AF/AE LOCK], move the camera as you compose the picture and then press shutter button fully.

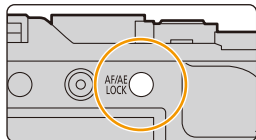

■ Setting the functions of [AF/AE LOCK]

MENU →  [Custom] →  [Focus / Release Shutter] → [AF/AE Lock]

[AE LOCK]	Only the exposure is locked. • When the exposure is set, [AEL] is displayed.
[AF LOCK]	Only the focus is locked. • When the subject is focused, [AFL] is displayed.
[AF/AE LOCK]	Both focus and exposure are locked. • [AFL] and [AEL] are displayed when the focus and the exposure are optimised.
[AF-ON]	Auto Focus is performed.

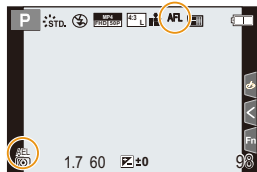

- AF Lock only is effective when taking pictures in Manual Exposure Mode.
- AE Lock only is effective when taking pictures with Manual Focus.
- Programme Shift can be set even when AE is locked.

Compensating the Exposure

Applicable modes:  P A S M

Use this function when you cannot achieve appropriate exposure due to the difference in brightness between the subject and the background.

Turn the exposure compensation dial to select the compensation value.

• With the exposure compensation dial, you can set a value in the -3 EV to $+3$ EV range.

- (A) Align with the indicator
- (B) Exposure compensation value

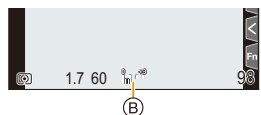
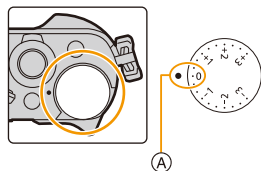

Underexposed



Compensate the exposure towards positive.

Properly exposed



Overexposed



Compensate the exposure towards negative.

■ Compensating the exposure over a wide range

- 1 Set the menu to assign [Exposure Comp.] to a function button. (P50)
- 2 Press the function button in the recording screen.
- 3 Rotate the control dial to compensate the exposure.

- (C) Exposure Bracket
- (D) Exposure Compensation

- When exposure is set with a function button, you can set a value in the -5 EV to $+5$ EV range.
- You can set the Exposure Bracket by pressing $\blacktriangle/\blacktriangledown$. (P132)

- 4 Press [MENU/SET] to set.

- You can also press the shutter button halfway to set.

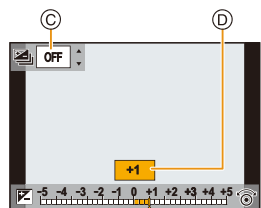

- In Manual Exposure Mode, you can compensate the exposure only when the ISO sensitivity is set to [AUTO].
- Depending on the brightness, this may not be possible in some cases.
- When [Auto Exposure Comp.] in [Flash] in the [Rec] menu is set to [ON], the brightness of the flash will automatically be set to the level appropriate to the selected Exposure Compensation. (This applies if the exposure is set with a function button)
- If you assign [Exposure Comp.] to a function button, the exposure compensation dial will be disabled.
- You can set a value between -3 EV and $+3$ EV while recording motion picture or performing recording with the 4K Photo or Post Focus function.
- When the Exposure Compensation value is out of the -3 EV to $+3$ EV range, the brightness of the recording screen will no longer change. It is recommended to record by checking the actual brightness of the recorded image in the Auto Review or playback screen.
- The exposure compensation value set with the function button is stored even if you set the camera on/off switch to [OFF]. (When [Exposure Comp. Reset] is set to [OFF])

Setting the Light Sensitivity

Applicable modes:

This allows the sensitivity to light (ISO sensitivity) to be set.

1 Press [ISO] (▲).

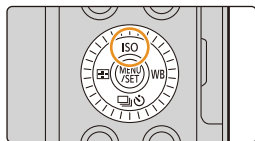

2 Select the ISO sensitivity by rotating the control dial.

(A) ISO sensitivity

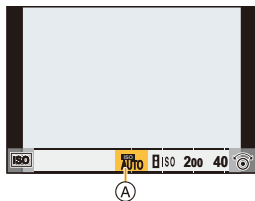

AUTO	The ISO sensitivity is automatically adjusted according to the brightness. • Up to [ISO3200]* ¹
ISO (Intelligent ISO)	The camera automatically sets the optimum ISO sensitivity and shutter speed to suit the movement of the subject and brightness of the scene to minimise the jitter of the subject. • Up to [ISO3200]* ¹ • The shutter speed is not fixed when the shutter button is pressed halfway. It is continuously changing to match the movement of the subject until the shutter button is pressed fully.
L.100 * ² , from 200 to 25600	The ISO sensitivity is fixed to various settings.

*1 When [ISO Auto Upper Limit (Photo)] in the [Rec] menu is set to [AUTO].

*2 When [Extended ISO] in the [Custom] ([Exposure]) menu is set to [ON].

3 Press [MENU/SET] to set.

• You can also press the shutter button halfway to set.

**Characteristics of the ISO sensitivity**

	200 \longleftrightarrow 25600	
Recording location	When it is light (outdoors)	When it is dark
Shutter speed	Slow	Fast
Noise	Less	Increased
Jitter of the subject	Increased	Less

- For details on the available flash range used when the ISO sensitivity is set to [AUTO], refer to P148.
- Cannot select [ISO] in the following cases:
 - Shutter-Priority AE Mode
 - Manual Exposure Mode
- Use the Quick menu (P48) to change the setting when [Direct Focus Area] (P187) is set to [ON], as the AF area is moved with the cursor button in this case.
- When [Multi Exp.] is set, the maximum setting is [ISO3200].
- When recording motion pictures or recording with the 4K Photo or Post Focus function, the setting items change to the following:
 - [AUTO], [200] to [6400] ([L.100] to [6400] if [Extended ISO] is set to [ON])

Adjusting the White Balance

Applicable modes:  P A S M

White Balance adjusts the colour of white according to the light source to make the overall colour hue closer to what is seen by the eye.

1 Press [WB] (▶).

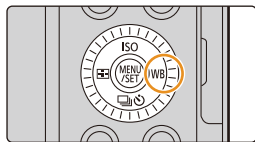



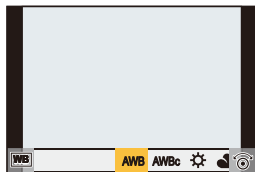

2 Rotate the control dial to select the White Balance.



<p>[AWB]/ [AWBc]</p>	<p>Automatic adjustment</p> <ul style="list-style-type: none"> • Under lighting such as incandescent lighting where reddish tones may occur: <ul style="list-style-type: none"> – With [AWB], reddish tones are maintained to reproduce the ambience of the scene more accurately. – With [AWBc], reddish tones are suppressed to reproduce the original colours of the subject more accurately. The same tones as [AWB] may be applied in a bright environment. • [AWB] and [AWBc] apply the same tones under light sources where reddish tones may not occur.
<p>[☀]</p>	<p>When taking pictures outdoors under a clear sky</p>
<p>[☁]</p>	<p>When taking pictures outdoors under a cloudy sky</p>
<p>[🏠]</p>	<p>When taking pictures outdoors in the shade</p>
<p>[💡]</p>	<p>When taking pictures under incandescent lights</p>
<p>[🔆WB]*</p>	<p>When taking pictures with the flash only</p>

* [AWB] is applied when you record motion picture or perform recording with the 4K Photo or Post Focus function.

	<p>A white object is recorded to set the White Balance. This is convenient for recording under multiple light sources.</p> <ol style="list-style-type: none"> Press ▲. Place a white object such as a piece of paper within the frame at the centre of the screen, and press [MENU/SET]. <ul style="list-style-type: none"> This will set the White Balance and return you to the recording screen. White Balance may not be set when the subject is too bright or too dark. Set the White Balance again after adjusting to appropriate brightness. 	
	<p>Set the White Balance Colour Temperature to suit the light source.</p> <ol style="list-style-type: none"> Press ▲. Press ▲/▼ to select the colour temperature and then press [MENU/SET]. <ul style="list-style-type: none"> You can set a colour temperature from [2500K] to [10000K]. 	

3 Press [MENU/SET] to set.

- You can also press the shutter button halfway to set.



Under fluorescent lighting, LED lighting fixture etc., the appropriate White Balance will vary depending on the lighting type.

Use [AWB], [AWBc], [AWB1], [AWB2], [AWB3] or [AWB4].

- The White Balance may not operate correctly if you take pictures using a flash and the subject is recorded outside of the effective flash range.

Auto White Balance

Depending on the conditions prevailing when pictures are taken, the pictures may take on a reddish or bluish tinge.

Please note that the White Balance may not work correctly in the cases below. In these cases, adjust the White Balance to anything other than [AWB] or [AWBc].

- When there are multiple light sources
- When there are no colours close to white

- [AWB] will work within this range.
- Blue sky
- Cloudy sky (Rain)
- Shade
- Sunlight
- White fluorescent light
- Incandescent light bulb
- Sunrise and sunset
- Candlelight

K=Kelvin Colour Temperature

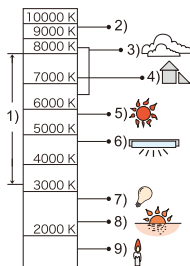

Finely adjusting the White Balance

You can finely adjust the White Balance when you cannot acquire the desired hue by setting the White Balance.

- 1 Select the White Balance and then press ▼.**
- 2 Press ▲/▼/◀/▶ to fine-adjust the White Balance.**

- ◀: [A] (AMBER: ORANGE)
- ▶: [B] (BLUE: BLUISH)
- ▲: [G] (GREEN: GREENISH)
- ▼: [M] (MAGENTA: REDDISH)

- You can also make fine adjustments by touching the White Balance graph.

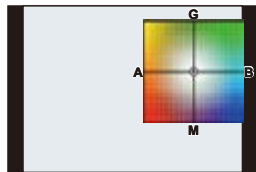

- To reset the position to the centre, press [DISP].
- You can set the White Balance Bracket by rotating the control dial. (P133)

- 3 Press [MENU/SET].**

- Press the shutter button halfway to return to the recording screen.

• If you finely adjust the White Balance to [A] (amber), the White Balance icon on the screen will change to orange.

If you finely adjust the White Balance to [B] (blue), the White Balance icon on the screen will change to blue.

• If you finely adjust the White Balance to [G] (green) or [M] (magenta), [+] or [-] appears beside the White Balance icon on the screen.

Select a Drive Mode

Applicable modes:

You can change what the camera will do when you press the shutter button.

1 Press (▼).

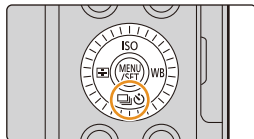

2 Press ◀/▶ to select the drive mode, and then press [MENU/SET].

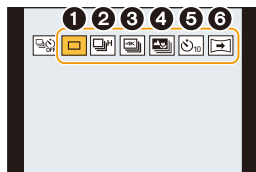

1 [Single]	When the shutter button is pressed, only one picture is recorded.
2 [Burst] (P99)	Recordings are made in succession while the shutter button is pressed.
3 [4K PHOTO] (P101)	When the shutter button is pressed, a 4K photo is recorded.
4 [Post Focus] (P111)	When the shutter button is pressed, Post Focus recording is performed.
5 [Self Timer] (P116)	When the shutter button is pressed, recording takes place after the set time has elapsed.
6 [Panorama Shot] (P118)	The pictures are recorded in succession while you press the shutter button and move the camera horizontally or vertically, and then the camera combines the pictures into a single panorama picture.

- Select to return to [Single] (default setting).

Taking Pictures using Burst Mode

Applicable modes: **[A]** **[Av]** **[P]** **[A]** **[S]** **[M]**

Pictures are taken continuously while the shutter button is pressed.

1 Press [**☺**] (**▼**).

2 Press **◀/▶** to select the burst icon ([**☺**], etc.), and then press **▲**.

3 Select the burst speed with **◀/▶**, and then press [**MENU/SET**].

[H]	Performs high-speed burst recording.
[M]	Performs medium-speed burst recording.
[L]	Performs low-speed burst recording.

4 Focus on the subject and take a picture.

- Hold down the shutter button fully to activate the Burst Mode.

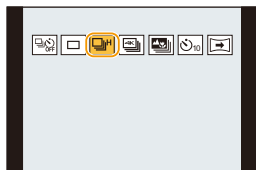

■ Cancelling the Burst Mode

Select [**□**] ([Single]) or [**☺ OFF**] from among the drive modes. (P98)

■ Notes on Burst Mode settings

		[H] (High speed)	[M] (Middle speed)	[L] (Low speed)
Burst speed (pictures/second)	AFS/MF	11	7	2
	AFF/AFC	5.5	5.5	
Live View during Burst Mode	AFS/MF	None	Available	Available
	AFF/AFC	Available		
Number of recordable pictures*	With RAW files	32 or more		
	Without RAW files	100 or more		

- * When recording is performed under the test conditions specified by Panasonic. The burst speed will become slower halfway. However, pictures can be taken until the capacity of the card becomes full. Depending on recording conditions, the number of burst pictures that can be taken will be reduced.

■ About the maximum number of pictures that can be taken continuously

When you press the shutter button halfway, the maximum number of pictures you can take continuously will appear.

Example: When 20 pictures can be taken: [r20]

- Once recording starts, the maximum number of pictures that can be taken continuously will decrease.

The recording speed slows down when [r0] appears.

- When [r99+] is displayed, you can take 100 or more pictures continuously.



■ Notes on focus in Burst Mode

The way focus is achieved varies according to the focus mode setting and the [Focus/Release Priority] setting in the [Custom] ([Focus / Release Shutter]) menu.

Focus settings	[Focus/Release Priority]	[H]	[M]/[L]
[AFS]	[FOCUS]	At the first picture	
	[BALANCE]		
	[RELEASE]		
[AFF]/[AFC] ^{*1}	[FOCUS]	Predicted focusing ^{*2}	Normal focusing ^{*3}
	[BALANCE]	Predicted focusing ^{*2}	
	[RELEASE]		
[MF]	—	Focus set with Manual Focus	

*1 When the subject is dark, the focus is fixed on the first picture.

*2 Burst speed takes priority, and focus is estimated within possible range.

*3 The burst speed may become slower.

- The burst speed may become slower depending on the following settings:
 - [Sensitivity]/[Picture Size]/[Quality]/[AFS/AFF/AFC]/[Focus/Release Priority]
- When the burst rate is set to [H] (when the focus setting is [AFS] or [MF]), the exposure will be set to that of the first picture. In other cases, the exposure will be adjusted for each picture.
- **It may take time to save pictures taken in Burst Mode on the card. If you take pictures continuously while saving, the maximum number of recordable pictures decreases. For continuous shooting, use of a high speed memory card is recommended.**

Not available in these cases:

- The Burst Mode is disabled in the following cases.
 - When using [Rough Monochrome]/[Silky Monochrome]/[Miniature Effect]/[Soft Focus]/[Star Filter]/[Sunshine] in [Filter Settings]
 - When using [Multi Exp.]
 - When recording with the flash (supplied)
 - When using [Time Lapse Shot]
 - When using [Stop Motion Animation] (only when [Auto Shooting] is set)

Recording 4K Photos

Applicable modes: **[A]** **[AF]** **[P]** **[A]** **[S]** **[M]**

The camera allows you to take burst pictures of 8 million pixels (approx.) at 30 frames/second. After taking these pictures, you can save the desired moment extracted from their burst file.

- Use a UHS Speed Class 3 card.

1 Press [] (▼).

2 Press ◀/▶ to select a 4K photo icon ([]), and then press ▲.

- By default, you can also perform the same operations as steps **1** and **2** by pressing [Fn1].

3 Select the recording method with ◀/▶, and then press [MENU/SET].

- You can also set the recording method in [4K PHOTO] in the [Rec] menu.

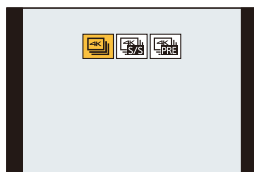
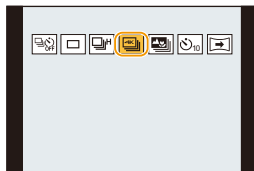

<p>[4K Burst]</p>	<p>For capturing the best shot of a fast-moving subject (e.g., sports, aeroplanes, trains) Audio recording: Not available</p>
<p>[4K Burst(S/S)] “S/S” is an abbreviation of Start/Stop.</p>	<p>For capturing unpredictable photo opportunities (e.g., plants, animals, children) Audio recording: Available*</p>
<p>[4K Pre-Burst]</p>	<p>For recording as needed whenever a photo opportunity arises (e.g., the moment when a ball is thrown) Audio recording: Not available</p>

* Audio is not played back when you perform playback with the camera.

4 Record a 4K photo.

- If you are using Auto Focus, [Continuous AF] will work during recording. Focus will be adjusted continuously.



MENU





[4K Burst]

- 1 Press the shutter button halfway.
- 2 Press and hold the shutter button fully for as long as you want to perform recording.

- (A) Press and hold
(B) Recording is performed

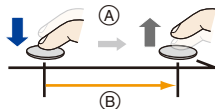
- Press the button fully slightly in advance. Recording starts approximately 0.5 seconds after it has been pressed fully.
- If you remove your finger from the shutter button immediately after the start of recording, up to a period of approximately 1.5 seconds after the moment that the finger has been removed may be recorded.





[4K Burst(S/S)]

- 1 Press the shutter button fully to start recording.
- 2 Press the shutter button fully again to stop recording.

- (C) Start (First)
(D) Stop (Second)
(E) Recording is performed

**Setting markers manually**

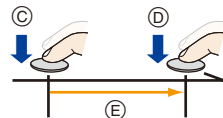
You can add markers if you press [Fn2] during recording. (Up to 40 markers per recording) When selecting and saving pictures from a 4K burst file, you can skip to the positions where you added markers.





[4K Pre-Burst]
Press the shutter button fully.

- (F) Approximately 1 second
(G) Recording is performed

- Auto Focus adjusts focus continuously, and except in Manual Exposure Mode, it also adjusts exposure continuously.
- Images may not be displayed as smoothly as when recording with the normal recording screen.

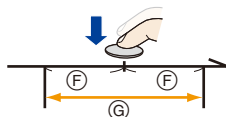

**Recording tips**

In situations where you want to lock focus and exposure, such as when the subject is not at the centre, use [AF/AE LOCK]. (P90)







- The camera will perform burst recording of a 4K photo and saves it as a 4K burst file with a [Rec Format] setting of [MP4].
- When [Auto Review] is enabled, the picture selection screen will be displayed automatically. To continue recording, press the shutter button halfway to display the recording screen.
- For information on how to select and save pictures from recorded 4K burst files, refer to P106.

■ Cancelling 4K Photo

In step 2, select [] ([Single]) or [] (P101)



Battery drainage and camera temperature

- If the ambient temperature is high or 4K photo recording is performed continuously, [] may be displayed and then recording may stop. Wait until the camera cools down.
- When [] ([4K Pre-Burst]) is set, the battery drains faster and the camera temperature rises. (The setting may switch to [] ([4K Burst]) to protect the camera.) Set [] ([4K Pre-Burst]) only when recording.

Notes on the 4K Photo function

■ To change the aspect ratio

You can switch the aspect ratio selector switch to set the aspect ratio of 4K photos.

■ To record the subject with reduced blur

You can reduce the blur of the subject by setting a faster shutter speed.

- 1 Change the Recording Mode to [S] (Shutter-Priority AE Mode). (P66)
- 2 Set the shutter speed by rotating the shutter speed dial.

- Approximate shutter speed for outdoor recording in fine weather conditions: 1/1000 seconds or faster.
- If you increase the shutter speed, the ISO sensitivity becomes higher, which may increase the noise on the screen.

■ Preventing camera shake when you are recording pictures

When you perform [Light Composition] or [Sequence Composition], we recommend using a tripod and taking pictures remotely by connecting the camera to a smartphone to prevent camera shake. (P238)

■ Shutter sound for recording

- When using [4K Burst] or [4K Pre-Burst], you can change the electronic shutter sound settings in [Shutter Vol.] and [Shutter Tone]. (P202)
- When recording with [4K Burst(S/S)], you can set the start/stop tone volume in [Beep Volume].
- High-speed burst recording can be used quietly when used in combination with [Silent Mode].

■ Scenes not suitable

Recording in extremely bright locations or indoors

When subjects are recorded in an extremely bright place or under fluorescent/LED lighting, the colour tone or brightness of the image may change, or horizontal stripes may appear on the screen.

Lowering the shutter speed may reduce the effect of the horizontal stripes.

Subjects that are moving fast

If you record a subject moving fast, the subject in the recorded pictures may appear distorted.

■ The camera's setup for the 4K Photo function

The camera's setup is automatically optimised for 4K photo recording.

- The following [Rec] menu items are fixed to the settings below:

[Picture Size]*	[4K] (8M)	[Quality]	[⚙]
	[4:3]: 3328×2496 [1:1]: 2880×2880 [16:9]: 3840×2160 [3:2]: 3504×2336	[Shutter Type]	[ESHTR]

* Changes according to the aspect ratio.

- 4K burst files are recorded with the settings indicated below:

Settings in the [Motion Picture] menu are not applied to 4K burst files.

[Rec Format]	[MP4]	[Continuous AF]	[ON]
[Rec Quality]	[4K/100M/30p]		

- When recording with the 4K Photo function, the ranges for the following functions differ from the ones available for taking pictures:

- Shutter speed: 1/30 to 1/16000
- [Min. Shtr Speed]: [1/1000] to [1/30]
- Exposure Compensation: –3 EV to +3 EV
- ISO sensitivity: [AUTO], [200] to [6400] ([L.100] to [6400] when [Extended ISO] is set)

- When recording with the 4K Photo function, the following functions are disabled:

- Flash
- Bracket Recording
- Programme Shift
- [AF Mode] ([+])
- [MF Assist] ([4K Pre-Burst] only)
- White Balance ([WB])

- The following menu items are disabled:

[Intelligent Auto]	[iHandheld Night Shot]/[iHDR]
[Rec]	[Picture Size]/[Quality]/[Color Space]/[Flash]/[Long Shtr NR]/[Shutter Type]/[Bracket]/[HDR]
[Custom]	[Rec Area]/[Face Recog.]/[Profile Setup]
[Setup]	[Economy] ([4K Pre-Burst] only)/[Monitor Display Speed]/[LVF Display Speed]

- Recording stops when the continuous recording time exceeds 15 minutes. When using an SDHC memory card, you can continue the recording of a 4K photo without interruption even if the file size exceeds 4 GB, but its burst file will be divided into smaller files for recording and playback. With an SDXC memory card, you can save a burst file size exceeding 4 GB as a single file.
- The following changes occur when recording 4K photos:
 - The angle of view becomes narrower.
 - [Location] in [Travel Date] cannot be recorded.
 - [AFF] in [AFS/AFF/AFC] cannot be set.
 - [Simultaneous Record w/o Filter] in [Filter Settings] is not available.
 - [Step Zoom] does not work during [4K Pre-Burst] recording.
- Scene Detection in Intelligent Auto Mode works the same way as when recording motion pictures.
- When the drive mode is set to 4K Photo, it is not possible to take pictures while recording motion picture. (Only when [📷] ([Photo Priority]) is set)
- To select and save pictures from 4K burst files on a PC, use the software "PHOTOfunSTUDIO". Please note that it is not possible to edit a 4K burst file as a motion picture.

Not available in these cases:

- The 4K Photo function is disabled when using the following settings:
 - When using [Rough Monochrome]/[Silky Monochrome]/[Miniature Effect]/[Soft Focus]/[Star Filter]/[Sunshine] in [Filter Settings]
 - When recording motion pictures
 - When using [Multi Exp.]
 - When using [Time Lapse Shot]
 - When using [Stop Motion Animation]

Selecting pictures from 4K burst file and saving

1 Select an image with the icon on the playback screen, and press **▲**.



- You can also perform the same operation by touching the icon .
- If the image was recorded with [4K Pre-Burst], proceed to step 3.

2 Drag the slide bar to make a rough selection of scenes.

Slide view screen

- For information on how to use the slide view screen, refer to P107.
- You can select its scenes on the 4K burst playback screen by touching  (Fn1). (P108)

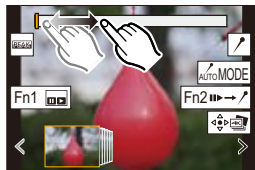

3 Drag the frames to select the frame you want to save as a picture.

- You can also perform the same operation by pressing **◀/▶**.



4 Touch to save the picture.

- The picture will be saved in JPEG format.



If you use [4K PHOTO Bulk Saving] in the [Playback] menu, you can bulk save 5 seconds' worth of 4K recording. (P217)

- The picture will be saved with recording information (Exif information), including its shutter speed, aperture and ISO sensitivity information.
- 4K burst files saved on a PC will be treated as MP4 motion pictures.

Operations during selecting pictures

■ Navigating the slide view screen

Position of the displayed frame

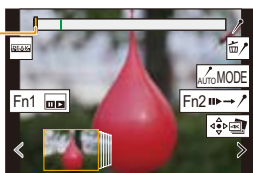

Button operation	Touch operation	Description of operation
	Dragging/ < / >	Selects a frame. • To change the frames displayed in slide view, select the frame at the left/right end, and touch [<] or [>].
 Press and hold	< / > Touch and hold	Continuously rewinds/forwards frame-by-frame.
—	 Touching/ Dragging	Selects the frame to be displayed. • The previous or next frame is displayed in slide view.
	Pinching out/in	Enlarges/reduces the display.
	Dragging	Moves the enlarged area (during enlarged display).
—		Switches a marker to be displayed. (P109)
[Fn1]		Displays the 4K burst playback screen.
[Fn2]		Switches to marker operation. (P109)
—		Adds/deletes a marker.
—		In-focus portions are highlighted with colour. ([Peaking]) • Switches in order of [PEAK OFF] → [PEAK L] ([LOW]) → [PEAK H] ([HIGH]).
[MENU/SET]		Saves the picture

■ Navigating the 4K burst playback screen

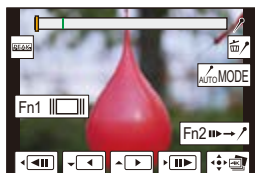

During pause



During continuous playback

Button operation	Touch operation	Description of operation
▲	▶/	Continuous playback/Pause (during continuous playback).
▼	◀/	Continuous rewind/Pause (during continuous rewind).
▶/⊙	▶▶/ ▶▶	Fast forward/Frame-by-frame forward (during pause).
◀/⊙	◀◀/◀◀	Fast rewind/Frame-by-frame rewind (during pause).
—	Touching/ Dragging	Selects the frames to be displayed (during pause).
🔄	Pinching out/in	Enlarges/reduces the display (during pause).
▲/▼/◀/▶	Dragging	Moves the enlarged area (during enlarged display).
[Fn1]	▢	Displays the slide view screen (during pause).
[Fn2]	▶▶→	Switches to marker operation.
—	📍/🗑️	Adds/deletes a marker.
—	PEAK	In-focus portions are highlighted with colour. ([Peaking]) • Switches in order of [PEAK OFF] → [PEAK L] ([LOW]) → [PEAK H] ([HIGH]).
[MENU/SET]	📁	Saves the picture (during pause).

- Each time you touch the screen twice, the display switches between enlarged and normal view.

Selecting and saving pictures on the TV screen

- Set [HDMI Mode (Play)] to either [AUTO] or a setting with a resolution of [4K/25p].
When connecting to a TV that does not support 4K motion picture, select [AUTO].
- If you display 4K burst files on a TV connected to the camera, they will be displayed only on the 4K burst playback screen.
- Depending on the TV to be connected, 4K burst files may not be played back correctly.

Marker

When selecting and saving pictures from a 4K burst file, you can select pictures easily by skipping between marked positions.

Two types of markers are available.

White marker:

This is manually set during recording or playback.

Green marker:

This is automatically set by the camera during recording. (Auto Marking function)



Marker operation screen

■ Skips to the marked positions

When [Fn1 / Fn2] is touched on the slide view screen or 4K burst playback screen, the marker operation screen appears and you can skip to the marked positions. Touch [Fn2 / Fn1] to return to the original operation.

Button operation	Touch operation	Description of operation
◀▶	◀ / ▶	Moves to the previous/next marker.



Auto Marking function

The camera automatically sets markers on scenes in which a face or the movement of a subject is detected.

(Example: At the scene when a vehicle passes by, a balloon bursts, or a person turns around)

- Up to 10 markers are displayed for each file.
- In the following cases, markers may not be set by the Auto Marking function depending on the recording conditions and the status of subjects.
 - The camera is moving because of panning or jitter
 - The movement of a subject is slow/small
 - The subject is small
 - A face is not facing front

■ Switches a marker to be displayed

Touch [] on the slide view screen, 4K burst playback screen, or marker operation screen.

[Auto]	Displays a marker on a scene in which a face or the movement of a subject is detected.
[Face Priority]	Displays a marker with preference given to a scene in which a face is detected.
[Motion Priority]	Displays a marker with preference given to a scene in which the movement of a subject is detected.
[Off]	Displays manually set markers only.

- You cannot delete markers set by the Auto Marking function.
- The markers set by the Auto Marking function may not be displayed correctly if you split the 4K burst file on another device and then play it back on the camera.
- In the following case, markers set by the Auto Marking function are not displayed.
 - 4K burst files recorded with [4K Pre-Burst]

Controlling Focus After Recording (Post Focus/ Focus Stacking)

Applicable modes: **[A] [Av] [P] [A] [S] [M]**

The camera allows you to take 4K burst pictures while shifting the focus to different areas. After taking these pictures, you can select the desired focus area. This function is suited for recording still objects.



4K burst recording while automatically shifting the focus.



Touch the desired focus point.



A picture with the desired focus point is made.

- Use a UHS Speed Class 3 card.
- We recommend that you use a tripod when recording images to be used for Focus Stacking.

1 Press [**☰**] (**▼**).

2 Press **◀/▶** to select the Post Focus icon ([**📷**]), and press [**MENU/SET**].

- By default, you can also perform the same operations as steps **1** and **2** by pressing [**Fn4**] and then selecting [**ON**].

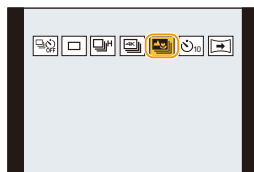

3 Decide on the composition, and press the shutter button halfway.

- Auto Focus will detect focus areas on the screen. (Excluding the edges of the screen)
- If no areas on the screen can be brought into focus, the focus display (**A**) will flash. Recording is not possible in this case.

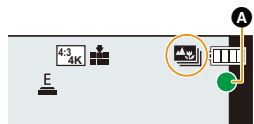



From the time you press the shutter button halfway until the end of recording:

- Maintain the same distance to the subject and the same composition.

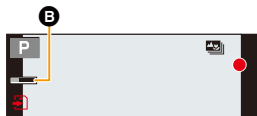
4 Press the shutter button fully to start recording.



- The focus point changes automatically while recording. When the icon (B) disappears, recording automatically ends.
- A motion picture will be recorded with [Rec Format] set to [MP4]. (Audio will not be recorded.)
- When [Auto Review] is enabled, a screen that lets you select the desired focus area will be displayed. (P113)

■ To cancel the [Post Focus] recording
In step 2, select [] ([Single]) or [] ([Off]). (P111)

About camera temperature

- When the ambient temperature is high or Post Focus recording is performed continuously, the camera may display [] and recording may stop. Wait until the camera cools down.

■ Limitations on the Post Focus function

- Since recording is performed in the same image quality as 4K photos, certain limitations apply to recording functions and menu settings. For details, refer to “The camera’s setup for the 4K Photo function” on P104.
- In addition to the limitations of the 4K Photo function, the following limitations apply to the Post Focus function:
 - Manual Focus operation is disabled.
 - Auto Focus Mode and [AFS/AFF/AFC] are not available.
 - Motion pictures cannot be recorded.
 - [Digital Zoom] is disabled.
 - The following [Custom] menu items are disabled: [Shutter AF]

Not available in these cases:

- The Post Focus function is disabled when using the following settings:
 - When using [Rough Monochrome]/[Silky Monochrome]/[Miniature Effect]/[Soft Focus]/[Star Filter]/[Sunshine] in [Filter Settings]
 - When [Multi Exp.] is set
 - When using [Time Lapse Shot]
 - When using [Stop Motion Animation]

Selecting the desired focus area and saving a picture (Post Focus)

- 1 **Select an image with the [▲▶] icon on the playback screen, and press ▲.**

- You can also perform the same operation by touching the icon [▲▶].



- 2 **Touch the desired focus area.**

- If a picture that is in focus is not available for the selected area, a red frame will be displayed. You cannot save a picture in this case.
- You cannot select the edges of the screen.



Button operation	Touch operation	Description of operation
▲/▼/◀/▶/ 	Touching	Selects a focus area. • It cannot be selected during enlarged display.
		Enlarges the display.
		Reduces the display (during enlarged display).
[Fn1]		Switches to the Focus Stacking function. (P114)
[Fn2]		In-focus portions are highlighted with colour. ([Peaking]) • Switches in order of [PEAK OFF] → [PEAK L] ([LOW]) → [PEAK H] ([HIGH]).
[MENU/SET]		Saves the picture.

- You can fine-adjust the focus by dragging the slide bar during enlarged display. (You can also perform the same operation by pressing ◀/▶.)



- 3 **Touch [◀▶] to save the picture.**

- The picture will be saved in JPEG format.



Not available in these cases:

- The Post Focus function cannot be set when the camera and a TV are connected with an HDMI micro cable.

Merging multiple pictures to widen the focus range (Focus Stacking)



(A) Focus: closer

(B) Focus: farther away

1 Touch in step 2 of “Selecting the desired focus area and saving a picture (Post Focus)” (P113).

• You can also perform the same operation by pressing [Fn1].

2 Touch the merging method.

[Auto Merging]	Automatically selects pictures that are suited to be merged, and merges them into a single picture. <ul style="list-style-type: none"> • Priority will be given to pictures with closer focus. • Perform the focus stacking and save the picture.
[Range Merging]	Merges pictures with specified focus areas into a single picture.

(When [Range Merging] is selected)

3 Touch the desired focus area.

- Specify at least two areas.
- In-focus areas between the selected two points are indicated.
- Parts that cannot be selected are indicated in grey.
- To cancel the selection, touch the focus area again.
- To select multiple areas, drag the screen.

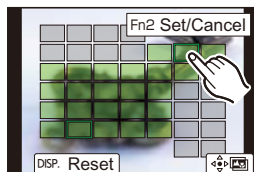
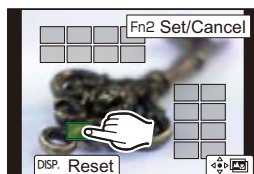

Button operation	Touch operation	Description of operation
/	Touching	Selects an area.
[Fn2]	[Set/Cancel]	Specifies/cancels an area.
[DISP.]	[All]	Selects all areas. (Before selecting areas)
	[Reset]	Cancels all selections. (After selecting areas)
[MENU/SET]		Merges pictures and saves the resulting picture.

4 Touch [] to merge the pictures and save the resulting picture.

- The picture will be saved in JPEG format. Recording information (Exif information) of the original picture with the closest focus distance, including the shutter speed, aperture, and ISO sensitivity, will also be recorded to the new picture.
- The camera may automatically correct the misalignments of pictures caused by camera shake. If they are corrected, the angle of view becomes slightly narrower when pictures are merged.
- Pictures may be merged into an unnatural picture in the following cases:
 - When the subject moves during recording
 - When the distance between subjects is great
 - When pictures are too defocused (If you take pictures with a larger aperture value, the resulting picture may look less unnatural.)
- You may not be able to use Focus Stacking for images recorded with other devices.



MENU



Taking Pictures with the Self-timer

Applicable modes: **[A]** **[Av]** **[P]** **[A]** **[S]** **[M]**

1 Press **[]** (**▼**).

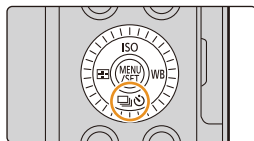

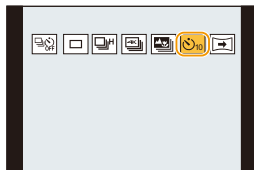

2 Press **◀/▶** to select the self-timer icon (**[]**, etc.), and then press **▲**.

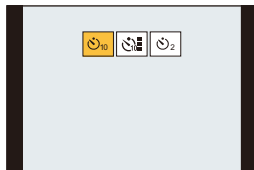

3 Press **◀/▶** to select the operation setting, and then press **[MENU/SET]**.



	Picture is taken 10 seconds after shutter is pressed.
	After 10 seconds the camera takes 3 pictures at about 2 seconds intervals.
	Picture is taken 2 seconds after shutter is pressed. • When using a tripod, etc., this setting is a convenient way to avoid the jitter caused by pressing the shutter button.

• Time setting for the self timer can also be set by [Self Timer] in the [Rec] menu.

4 Press the shutter button halfway to focus and then press it fully to take the picture.

- Focus and exposure will be set when the shutter button is pressed halfway.
- After the self-timer indicator flashes, recording starts.

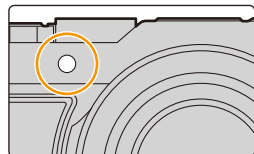

■ Cancelling the self-timer

Select [] ([Single]) or [] from among the drive modes. (P98)

- The self-timer can also be cancelled by turning off the camera. (When [Self Timer Auto Off] (P196) is set to [ON])

- We recommend using a tripod when recording with the self-timer.

Not available in these cases:

- It cannot be set to [] in the following cases.
 - When [Simultaneous Record w/o Filter] of [Filter Settings] is set to [ON]
 - When recording with the Bracket function
 - When using [Multi Exp.]
- Self-timer is disabled in the following cases.
 - When recording motion pictures
 - When using [Time Lapse Shot]
 - When using [Stop Motion Animation] (only when [Auto Shooting] is set)



MENU







Recording panorama pictures

Applicable modes:   **P A S M**

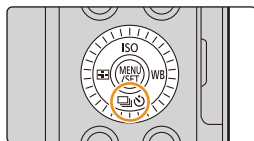

Consecutive photos taken while the camera is moved are combined to form a panorama.

1 Press [] ().



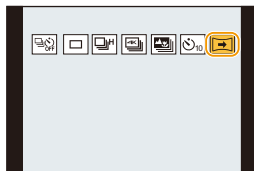



2 Press / to select the panorama icon ([], etc.), and then press .

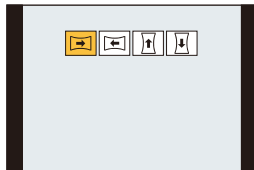

3 Press / to select the recording direction and then press [MENU/SET].



	Left → Right	A horizontal guide line is displayed.
	Right → Left	
	Down → Up	A vertical guide line is displayed.
	Up → Down	

4 Press the shutter button halfway to focus.

5 Press the shutter button fully and move the camera in a small circle in the direction of the arrow on the screen.

Recording from left to right

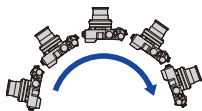

Picture size: [STANDARD]

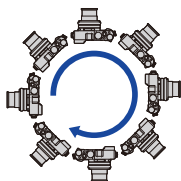

Picture size: [WIDE]



(A)

(B)

- Move the camera at a constant speed.
Pictures may not be able to be recorded properly if the camera is moved too fast or slow.

- (A) Recording direction and progress (Guide)
- (B) Horizontal/vertical guide

6 Press the shutter button once again to end the picture recording.

- Recording can also be ended by keeping the camera still while recording.
- Recording can also be ended by moving the camera to the end of the guide.



To add image effects (filters)

By default you can set the image effect by rotating the control ring.

- 1 Rotate the control ring to select the image effect.
 - 2 Press [MENU/SET].
- You can also set the effect by touching [Filter Settings] (P123) in the [Rec] menu or touching  (P129) on the touch panel.
 - Refer to P123 to P129 for details about the adjustment and limitations of image effects.

■ Changing panorama picture settings

MENU →  **[Rec]** → **[Panorama Settings]**

[Direction]	Sets the recording direction.
[Picture Size]	Sets the angle of view (image size). [STANDARD]/[WIDE]

- The number of recording pixels in the horizontal and vertical directions of the panorama picture varies depending on the image size, the recording direction and the number of combined pictures.

The maximum number of pixels is shown below.

Image size	Recording direction	Horizontal Resolution	Vertical Resolution
[STANDARD]	Horizontal	8176 pixels	1920 pixels
	Vertical	2560 pixels	7680 pixels
[WIDE]	Horizontal	8176 pixels	960 pixels
	Vertical	1280 pixels	7680 pixels

■ Technique for Panorama Shot Mode



- Ⓐ Move the camera in the recording direction without shaking it. (If the camera shakes too much, pictures may not be recorded, or the created panorama picture may become narrower (smaller).)
- Ⓑ Move the camera towards the edge of the range you wish to record. (However, the last frame is not recorded to the end.)

■ About playback

Pressing ▲ will start scrolling playback automatically in the same direction as the recording.

- The following operations can be performed during scrolling playback.

		Start panorama playback/Pause*
		Stop

- * While paused, you can drag the screen to scroll forwards or backwards. If you touch the scroll bar, the playback position jumps to the touched position.

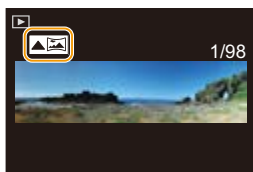

■ To cancel the panorama function

Select [] ([Single]) or [] from the drive mode (P98).

- The zoom position is fixed to Wide.
- The shutter type is fixed to the electronic shutter.
- The camera automatically sets the aperture value and shutter speed during panorama recording. The settings of the aperture ring and shutter speed dial are disabled.
- The focus, White Balance, and exposure are fixed at the optimum values for the first picture. As a result, if the focus or brightness changes substantially during recording, the entire panorama picture may not have the suitable focus or brightness.
- When multiple pictures are combined to create a single panorama picture, the subject may appear distorted or the connection points may be noticeable in some cases.

Not available in these cases:

- Panorama recording is disabled in the following cases:
 - When using [Multi Exp.]
 - When using [Time Lapse Shot]
 - When using [Stop Motion Animation]
- A panorama picture may not be able to be created, or the pictures may not be combined properly when recording the following subjects or under the recording conditions below.
 - Subjects with a single, uniform colour or repetitive pattern (such as the sky or a beach)
 - Moving subjects (person, pet, car, waves, flowers blowing in the breeze, etc.)
 - Subjects where the colour or patterns change in a short time (such as an image appearing on a display)
 - Dark places
 - Locations with flickering light sources such as fluorescent lights or candles

6.

Recording Images that Suit Your Subjects and Purposes

Changing the Aspect Ratio

Applicable modes: **P A S M**

You can easily switch the aspect ratio of still pictures using the aspect ratio selector switch.

Switching the aspect ratio selector switch

(A) Align with the indicator

[4:3]	Aspect ratio of a 4:3 TV
[1:1]	Aspect ratio of a square image
[16:9]	Aspect ratio of high-definition TV, etc.
[3:2]	Aspect ratio of standard film cameras

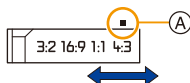
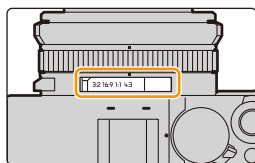

Not available in these cases:

- The setting of the aspect ratio selector switch is disabled during panorama recording.

Taking Pictures with different image effects (Filter)

Applicable modes:

You can record with additional image effects.

Image effects can be added even when you take panorama pictures.

1 Select the menu.

MENU → **[Rec]/** **[Motion Picture]** → **[Filter Settings]** → **[Filter Effect]** → **[SET]**

2 Press ▲/▼ to select the image effects (filters).

(A) Preview display

- You can also select the image effects (filters) by touching the example images.

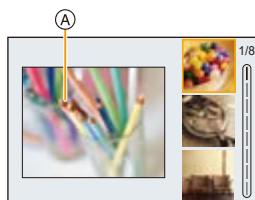

3 Press [MENU/SET].



Displaying the description of each image effect

Press **[DISP.]** while the image effect selection screen is displayed.

- When it is set to the guide display, explanations for each picture effect are displayed.

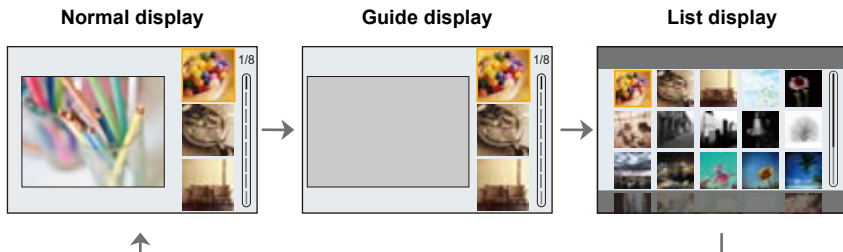

- The following items are fixed to the settings below when you set the image effect:
 - [White Balance]: [AWB]
 - [Photo Style]: [Standard]
 - [Color Space]: [sRGB]
 - [Highlight Shadow]: [Standard]
 - [i.Dynamic]: [OFF]
 - [HDR]: [OFF]
- Depending on the image effect, the recording screen may seem as if frames are missed.
- [Rough Monochrome]/[Silky Monochrome]/[Soft Focus]/[Star Filter]/[Sunshine] are not available in the following case.
 - When recording motion pictures
- The available ISO sensitivity settings will be limited up to [ISO3200].
- The ISO sensitivity for [High Dynamic] will be fixed to [AUTO].
- The following limitations apply when Panorama Shot Mode is set:
 - [Toy Effect]/[Toy Pop]/[Miniature Effect]/[Sunshine] are not available.
 - The image effects of [Rough Monochrome]/[Silky Monochrome]/[Soft Focus]/[Star Filter] will not be applied to the screen during recording.
 - When [High Key] is set, its effect may not appear clearly in scenes that are not bright enough.

Types of image effects



[Expressive]



[Retro]



[Old Days]



[High Key]



[Low Key]



[Sepia]



[Monochrome]



[Dynamic Monochrome]



[Rough Monochrome]



[Silky Monochrome]



[Impressive Art]



[High Dynamic]



[Cross Process]



[Toy Effect]



[Toy Pop]



[Bleach Bypass]



[Miniature Effect]



[Soft Focus]



[Fantasy]



[Star Filter]





[One Point Color]



[Sunshine]

■ Setting the type of defocus ([Miniature Effect])

- 1 Touch [] and then select [].
- 2 Press $\blacktriangle/\blacktriangledown$ or $\blacktriangleleft/\blacktriangleright$ to move the in-focus portion.
 - You can also move the in-focus portion by touching the screen on the recording screen.
 - To set the recording orientation (defocus orientation), touch [].
- 3 Rotate the Control dial to change the size of in-focus portion.
 - The portion can also be enlarged/reduced by pinching out/pinching in the screen.
 - To reset the in-focus portion setting to the default, press [DISP.].
- 4 Press [MENU/SET] to set.





- No sound is recorded in motion pictures.
- Approximately 1/8 of the time period is recorded.
(If you record for 8 minutes, the resulting motion picture recording will be approximately 1 minute long.)

The displayed available recording time is approximately 8 times.

Depending on the recording frame rate of the motion picture, the recording time of the motion picture and the available recording time may differ from the values above.

- If you end motion picture recording after a short time, the camera may go on recording for a certain period.







■ Set the colour to leave in ([One Point Color])

- 1 Touch [] and then select [].
- 2 Select the colour you want to leave by moving the frame with $\blacktriangle/\blacktriangledown/\blacktriangleleft/\blacktriangleright$.
 - You can also select the colour you want to leave by touching the screen.
 - To return the frame back to the centre, press [DISP.].
- 3 Press [MENU/SET] to set.



- Depending on the subject, the set colour may not be left in.

■ Setting the position and size of the light source ([Sunshine])

- 1 Touch  and then select .
- 2 Press /// to move the centre position of the light source.
 - The position of the light source can also be moved by touching the screen.



Point for when placing the centre of the light source

A more natural appearance can be created by placing the centre of the light source outside the image.

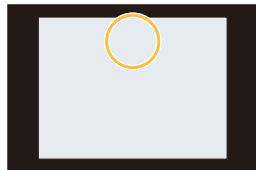

- 3 Adjust the size of the light source by rotating the Control dial.
 - The display can also be enlarged/reduced by pinching out/pinching in.
 - To reset the light source setting to the default, press [DISP].
- 4 Press [MENU/SET] to set.

Adjust the effect to fit your preferences







- 1 Press .
- 2 Rotate the control dial to adjust the setting.
 - Press [MENU/SET] to return to the recording screen.



Image effect	Items that can be set		
[Expressive]	Freshness	Understated colours	⇔ Pop colours
[Retro]	Colour	Yellowish tinge	⇔ Reddish tinge
[Old Days]	Contrast	Low contrast	⇔ High contrast
[High Key]	Colour	Pinkish tinge	⇔ Aquamarinish tinge
[Low Key]	Colour	Reddish tinge	⇔ Bluish tinge
[Sepia]	Contrast	Low contrast	⇔ High contrast

Image effect	Items that can be set		
[Monochrome]	Colour	Yellowish tinge	↔ Bluish tinge
[Dynamic Monochrome]	Contrast	Low contrast	↔ High contrast
[Rough Monochrome]	Grittiness	Less gritty	↔ Grittier
[Silky Monochrome]	Extent of defocus	Weak defocus	↔ Strong defocus
[Impressive Art]	Freshness	Black and white	↔ Pop colours
[High Dynamic]	Freshness	Black and white	↔ Pop colours
[Cross Process]	Colour	Greenish tinge/Bluish tinge/Yellowish tinge/Reddish tinge	
[Toy Effect]	Colour	Orangish tinge	↔ Bluish tinge
[Toy Pop]	Area with reduced peripheral brightness	Small	↔ Large
[Bleach Bypass]	Contrast	Low contrast	↔ High contrast
[Miniature Effect]	Freshness	Understated colours	↔ Pop colours
[Soft Focus]	Extent of defocus	Weak defocus	↔ Strong defocus
[Fantasy]	Freshness	Understated colours	↔ Pop colours
[Star Filter]		Length of the rays of light Short ↔ Long	
		Number of the rays of light Smaller ↔ Larger	
		Angle of the rays of light Rotate to the left ↔ Rotate to the right	
[One Point Color]	Amount of colour left	Small amount of colour	↔ Large amount of colour
[Sunshine]	Colour	Yellowish tinge/Reddish tinge/Bluish tinge/Whitish tinge	

Change the settings by using the touch screen

- 1 Touch .
- 2 Touch the item you want to set.
 - []: Image effect ON/OFF
 - [EXPS]: Selects an image effect (filter)
 - []: Adjusts an image effect
- 3 Drag the slide bar to adjust the setting.
 - Press [MENU/SET] to return to the recording screen.



Taking a picture with and without an image effect simultaneously ([Simultaneous Record w/o Filter])

You can press the shutter button once and take two pictures simultaneously, one with an image effect and the other one without it.

MENU →  **[Rec]** → **[Filter Settings]** → **[Simultaneous Record w/o Filter]**

Settings: [ON]/[OFF]

- A picture with an image effect will be taken first, followed by a picture without it.
- Only an image with an image effect is displayed for Auto Review.

Not available in these cases:

- In the following cases, [Simultaneous Record w/o Filter] does not work:
 - Recording still pictures while recording a motion picture
 - When recording 4K photos
 - When recording with the Post Focus function
 - When recording in Burst Mode
 - When using [Panorama Shot]
 - When [Quality] is set to [RAW₁], [RAW₂] or [RAW]
 - When recording with the Bracket function
 - When using [Time Lapse Shot]
 - When using [Stop Motion Animation]

Taking Pictures While Adjusting a Setting Automatically (Bracket Recording)

Applicable modes: **P** **A** **S** **M**

You can take multiple pictures while automatically adjusting a setting by pressing the shutter button.

1 Select the menu.

MENU → [Rec] → [Bracket] → [Bracket Type]	
Exposure Bracket	Press the shutter button to perform recording while adjusting the exposure. (P132)
Aperture Bracket	Press the shutter button to perform recording while adjusting the aperture. (P132) • Available in Aperture-Priority AE Mode or when the ISO sensitivity is set to [AUTO] in Manual Exposure Mode.
FOCUS Focus Bracket	Press the shutter button to perform recording while adjusting the focus position. (P133)
WB White Balance Bracket	Press the shutter button once to take three pictures with different white balance settings automatically. (P133)
Aspect Bracket	When you press the shutter button once, the camera automatically takes four pictures with four types of aspect ratios (4:3, 3:2, 16:9, and 1:1). (The shutter sounds only once.) • The range that can be recorded for each aspect ratio is displayed. 

2 Press ▲/▼ to select [More Settings] and then press [MENU/SET].

- For information on [More Settings], refer to the page that describes each function. Aspect Bracket does not have [More Settings].
- Press the shutter button halfway to exit the menu.

3 Focus on the subject and take a picture.

- When Exposure Bracket is selected, the bracket display flashes until all of the pictures you have set are taken. If you change the bracket settings or turn off the camera before all of the pictures you have set are taken, the camera restarts recording from the first picture.

■ To cancel [Bracket Type]

Select [OFF] in step 1.

- The following changes occur when Aspect Bracket is set:
 - When [Picture Size] is set to [S], the setting is automatically changed to [M].
 - The same shutter speed, aperture value, focus, [Sensitivity], [Exposure Comp.] and [White Balance] settings are used for all four pictures.

Not available in these cases:

- Bracket recording is disabled in the following cases.
 - When using [Rough Monochrome]/[Silky Monochrome]/[Miniature Effect]/[Soft Focus]/[Star Filter]/[Sunshine] in [Filter Settings]
 - When recording motion pictures
 - When recording 4K photos
 - When recording with the Post Focus function
 - When using [Panorama Shot]
 - When using [Multi Exp.]
 - When using [Time Lapse Shot]
 - When using [Stop Motion Animation] (only when [Auto Shooting] is set)
 - When recording with the flash (except for when using White Balance Bracket or Aspect Bracket)
- White Balance Bracket is disabled in the following cases:
 - Intelligent Auto Plus Mode
 - When using [Filter Settings]
 - When recording in Burst Mode
 - When [Quality] is set to [RAW $\frac{1}{2}$], [RAW $\frac{1}{4}$] or [RAW]
- Aspect Bracket is disabled in the following cases:
 - When [Toy Effect]/[Toy Pop] in [Filter Settings] is used
 - When recording in Burst Mode
 - When [Quality] is set to [RAW $\frac{1}{2}$], [RAW $\frac{1}{4}$] or [RAW]

Exposure Bracket

About [More Settings] (step 2 in P130)

[Step]	Sets the number of pictures to be taken and the exposure compensation range. [3•1/3] (Takes three pictures with an interval of 1/3 EV) to [7•1] (Takes seven pictures with an interval of 1 EV)
[Sequence]	Sets the order in which pictures are taken.
[Single Shot Setting]*	[□]: Takes one picture each time you press the shutter button. [📷]: Takes all the pictures set to be taken when you press the shutter button once.

* Not available for burst recording. When using burst recording, if you press and hold the shutter button, recording will be performed continuously until a specified number of pictures are taken.

[Step]: [3•1/3], [Sequence]: [0/-/+]

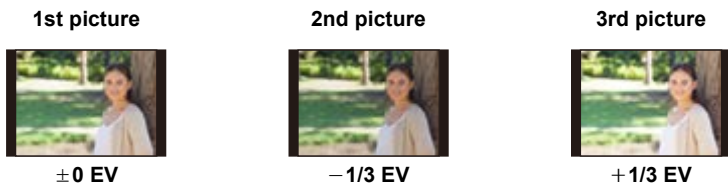

• When taking pictures using Exposure Bracket after setting the Exposure Compensation value, the pictures taken are based on the selected Exposure Compensation value.

Aperture Bracket

Recording Mode: [A] [M]

About [More Settings] (step 2 in P130)

[Image Count]	[3], [5]: Takes a specified number of pictures with different aperture values within the range based on the initial aperture value. [ALL]: Takes pictures using all aperture values.
---------------	---

• When using burst recording, if you press and hold the shutter button, recording will be performed until a specified number of pictures are taken.

Example:

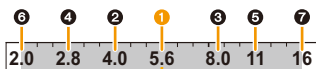

When the initial position is set to F5.6:

① first picture, ② second picture, ③ third picture... ⑦ seventh picture

Focus Bracket

About [More Settings] (step 2 in P130)

[Step]	Sets the interval between focus positions.
[Image Count]*	Sets the number of pictures to be taken.
[Sequence]	<p>[0/-/+]: Alternately moves the focus position closer and farther away within the range centred on the initial position as you take pictures.</p> <p>[0/+]: Moves the focus position farther away from the initial position as you take pictures.</p>

- * Not available for burst recording. When using burst recording, if you press and hold the shutter button, recording will be performed continuously until a specified number of pictures are taken.



(A) Focus: closer

(B) Focus: farther away

① first picture, ② second picture... ⑤ fifth picture...

- Pictures taken with Focus Bracket are displayed as group images.

White Balance Bracket

About [More Settings] (step 2 in P130)

Rotate the control dial to adjust the correction range, and press [MENU/SET].

: Horizontal ([A] to [B])

: Vertical ([G] to [M])

- You can also set the correction range by touching **A**.

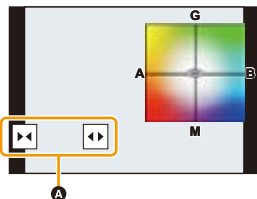

Taking Pictures Automatically at Set Intervals ([Time Lapse Shot])

Applicable modes: **[A] [Av] [P] [A] [S] [M]**

The camera can automatically take pictures of subjects such as animals or plants as time elapses and create a motion picture.

- **Set the date and time settings in advance. (P32)**
- Recorded pictures are displayed as group pictures.

1 Select the menu.

[MENU] → **[Rec]** → **[Time Lapse Shot]**



[Shooting Interval Setting]	[ON]	Sets the time from recording start time to the next recording start time.
	[OFF]	After recording is finished, the next recording is started without any interval.
[Start Time]	[Now]	Starts the recording by fully-pressing the shutter button.
	[Start Time Set]	Any time up to 23 hours 59 minutes ahead can be set. Select the item (hour or minute) by pressing ◀/▶, set the start time by pressing ▲/▼, and then press [MENU/SET].
[Image Count]/ [Shooting Interval]*1		The number of pictures and the recording interval can be set. ◀/▶: Select the item (number of pictures/minute/second) ▲/▼: Setting [MENU/SET]: Set

*1 Can be set only when [Shooting Interval Setting] is set to [ON].



- The estimated recording ending time is displayed on the setting screen. It is displayed under the following conditions when [Shooting Interval Setting] is set to [OFF]:
 - Recording Mode: Shutter-Priority AE Mode or Manual Exposure Mode
 - Focus Mode: [MF]
- The camera may not be able to record using the pre-set interval and number of pictures to be recorded or may not finish recording at the estimated recording ending time under some recording conditions.

2 Press ▲/▼ to select [Start] and then press [MENU/SET].

3 Press the shutter button halfway to focus.

4 Press the shutter button fully.

- The recording starts automatically.
- During recording standby, the camera will turn off automatically if no operation is performed for a certain period. The Time Lapse Shot is continued even with the camera turned off. When the recording start time arrives, the camera turns on automatically. To turn on the camera manually, press the shutter button halfway.
- Operations during recording standby (The camera is turned on)

Button operation	Touch operation	Description of operation
[Fn1] ^{*2}	 *3	Displays a selection screen that lets you pause or stop the recording
		Displays a selection screen that lets you resume or stop the recording (during pause)

- *2 When you record pictures by setting [Shooting Interval Setting] to [OFF], you can press [Fn1] even while recording is in progress. After recording (exposure) of a picture taken at the time when you pressed [Fn1] is finished, a selection screen is displayed.
- *3 When you record pictures by setting [Shooting Interval Setting] to [OFF], you cannot perform touch operation.

5 Select the methods for creating a motion picture.

- The recording format is set to [MP4].

[Rec Quality]	Sets the quality of a motion picture.
[Frame Rate]	Sets the number of frames per second. The larger the number is, the smoother the motion picture will be.
[Sequence]	[NORMAL]: Splices pictures together in recording order. [REVERSE]: Splices pictures together in reverse recording order.

6 Press ▲/▼ to select [OK] and then press [MENU/SET].

- Motion pictures can also be created from [Time Lapse Video] in the [Playback] menu. (P225)

- This function is not for use in a security camera.
- When using zoom, the camera could tilt when the lens barrel extends. Make sure to secure the camera in place with a tripod or by other means.
- [Time Lapse Shot] is paused in the following cases.
 - When the charge on the battery runs out
 - When the camera on/off switch is set to [OFF](When [Shooting Interval] is set to 31 seconds or longer)
During [Time Lapse Shot], you can replace the battery and the card, and then restart by turning on this unit. (Note that the pictures taken after replacing the card will be saved as a separate set of group pictures.)
Set the camera on/off switch to [OFF] when replacing the battery or card.
- We recommend using auto focus for time lapse recording in cases where a long [Shooting Interval] is set and the camera will turn off automatically between shots.
- When creating motion pictures with a [Rec Quality] setting of [4K], recording times are limited to 29 minutes and 59 seconds.
 - In addition, when using an SDHC memory card, you cannot create motion pictures with a file size exceeding 4 GB.
 - When using an SDXC memory card, you can create motion pictures with a file size exceeding 4 GB.
- A motion picture with a [Rec Quality] setting of [FHD] or [HD] cannot be created if the recording time exceeds 29 minutes and 59 seconds or the file size exceeds 4 GB.



Not available in these cases:

- This function is not available in the following cases:
 - When using [Panorama Shot]
 - When using [Multi Exp.]
 - When using [Stop Motion Animation]

Creating Stop Motion Pictures ([Stop Motion Animation])

Applicable modes: **[M] [A] [P] [A] [S] [M]**

A stop motion picture is created by splicing pictures together.

- Set the date and time settings in advance. (P32)
- Recorded pictures are displayed as group pictures.

1 Select the menu.

[MENU] →  **[Rec]** → **[Stop Motion Animation]**



[Auto Shooting]	[ON]: Takes pictures automatically at a set recording interval. [OFF]: This is for taking pictures manually, frame by frame.
[Shooting Interval]	(Only when [Auto Shooting] is set to [ON]) ◀/▶: Select the item (second) ▲/▼: Setting [MENU/SET]: Set

2 Press **▲/▼** to select **[Start]** and then press **[MENU/SET]**.

3 Press **▲/▼** to select **[New]** and then press **[MENU/SET]**.

4 Press the shutter button halfway to focus.

5 Press the shutter button fully.

6 (When taking the second and subsequent pictures)

Move the subject to decide on the composition and then take the picture.



- Repeat recording in the same way.
- If this unit is turned off while recording, a message for resuming the recording is displayed when the camera is turned on. Selecting [Yes] allows you to continue the recording from the interruption point.
- Up to 9999 frames can be recorded.

Recording materials skillfully

- The recording screen displays up to two pictures taken previously. Use them as reference for the amount of movement.
- To check the recorded pictures, press [▶].
Unnecessary pictures can be deleted by pressing [🗑️].
To return to the recording screen, press [▶] again.

7 Touch [] to end the recording.

- It can also be ended by selecting [Stop Motion Animation] from the [Rec] menu and then pressing [MENU/SET].
- When [Auto Shooting] is set to [ON], select [End] on the confirmation screen.
(If [Pause] has been selected, press the shutter button fully to resume the recording.)
- After the recording stops, a confirmation screen will be displayed, asking whether to proceed to create a motion picture.
To create a motion picture, select [Yes].

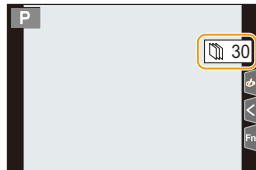

8 Select the methods for creating a motion picture.

- The recording format is set to [MP4].

[Rec Quality]	Sets the quality of a motion picture.
[Frame Rate]	Sets the number of frames per second. The larger the number is, the smoother the motion picture will be.
[Sequence]	[NORMAL]: Splices pictures together in recording order. [REVERSE]: Splices pictures together in reverse recording order.

9 Press ▲/▼ to select [OK] and then press [MENU/SET].

- You can also create motion pictures using [Stop Motion Video] in the [Playback] menu. (P225)

■ Adding pictures to the Stop Motion Animation group

Selecting [Additional] in step 3 will display group pictures recorded with [Stop Motion Animation].

Select a set of group pictures, and then press [MENU/SET].

- Recording takes time under certain recording conditions, such as when the flash is used for recording. Automatic recording, as a result, may not take place at set intervals.
- When creating motion pictures with a [Rec Quality] setting of [4K], recording times are limited to 29 minutes and 59 seconds.
 - When using an SDHC Memory Card, you cannot create motion pictures with a file size exceeding 4 GB.
 - When using an SDXC Memory Card, you can create motion pictures with a file size exceeding 4 GB.
- A motion picture with a [Rec Quality] setting of [FHD] or [HD] cannot be created if the recording time exceeds 29 minutes and 59 seconds or the file size exceeds 4 GB.
- A picture cannot be selected from [Additional] when it is the only one that was taken.



Not available in these cases:





- This function is not available in the following cases:
 - When using [Panorama Shot]
 - When using [Multi Exp.]
 - When using [Time Lapse Shot]

Image Stabiliser

Applicable modes:   **P** **A** **S** **M**

Automatically detects and prevents jitter.

MENU →  **[Rec]/**  **[Motion Picture]** → **[Stabilizer]**

 ((Normal))	Camera shake is corrected for up/down, and left/right movements.	
 ((Panning))	Camera shake is corrected for up/down movements. This mode is ideal for panning (a method of taking pictures which involves turning the camera to track the movements of a subject which continues to move in a fixed direction).	
[OFF]	[Stabilizer] does not work.	



Preventing jitter (camera shake)

When the jitter alert [] appears, use **[Stabilizer]**, a tripod or the self-timer.

- Shutter speed will be slower particularly in the following cases. Keep the camera still from the moment the shutter button is pressed until the picture appears on the screen.

We recommend using a tripod.

– Slow Sync.

– Slow Sync./Red-Eye Reduction

– When you set to a slow shutter speed

- It is recommended to disable the Image Stabiliser when using a tripod.
- The stabiliser function may not be effective in the following cases.
Be careful of camera jitter when you press the shutter button.
 - When there is a lot of jitter
 - When the zoom magnification is high
 - When using the Digital Zoom
 - When taking pictures while following a moving subject
 - When the shutter speed becomes slower to take pictures indoors or in dark places
- The panning effect in [Panning] is more difficult to achieve in the following cases.
 - In brightly lit places such as in broad daylight on a summer's day
 - When the shutter speed is faster than 1/100 seconds
 - When you move the camera too slowly because the subject is moving slowly (The background will not become a blur)
 - When the camera does not keep up with the subject satisfactorily

 **Not available in these cases:**

- In Panorama Shot Mode, the [Stabilizer] setting will switch to [Panning] even if it is set to [Normal].
- In the following cases, the [Stabilizer] will switch to [Normal], even if it is set to [Panning]:
 - During motion picture recording
 - When recording 4K photos
 - When recording using [Post Focus]

Taking Pictures with the Zoom

Applicable modes: **[iA] [iA+] P A S M**

Zoom types and use

■ Screen display

The illustration is an example of when using Optical Zoom, [i.Zoom], and [Digital Zoom] in Programme AE Mode.

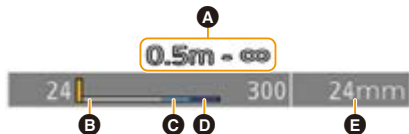

- A** Recordable range indication (focus range)
- B** Optical Zoom range
- C** i.Zoom range
- D** Digital Zoom range
- E** Current zoom position (Focal lengths the same as those of a 35 mm film camera)

Optical zoom

You can zoom in without degrading the picture quality.

Maximum magnification: 3.1×



Not available in these cases:

- Zoom is not available during panorama recording.

Extra Optical Zoom

This function works when any of the picture sizes (P172) indicated with **EX** is selected. You can zoom in further than you can with the Optical Zoom without deteriorating the image quality.

Maximum magnification: 6.2×

(This includes the optical zoom magnification. The magnification level differs depending on [Picture Size] setting.)

Not available in these cases

- This function is not available in the following cases:
 - When using [Toy Effect]/[Toy Pop] in [Filter Settings]
 - When recording 4K photos
 - When recording with [Post Focus]
 - When using [Panorama Shot]
 - When [HDR] is set to [ON]
 - When using [Multi Exp.]
 - When [iHandheld Night Shot] is set to [ON]
 - When [iHDR] is set to [ON]
 - When [Quality] is set to [RAW]
 - When [Rec Area] is set to [
 - When recording motion pictures

Intelligent Zoom

You can zoom in up to twice the original zoom magnification while minimising the deterioration of the image quality.

MENU →  **[Rec]/ [Motion Picture]** → **[i.Zoom]**

Settings: [ON]/[OFF]

- This function works automatically in Intelligent Auto Mode.
- If you set the [Picture Size] to [S], you can zoom in up to 1.5× the original zoom.

Not available in these cases:

- This function is not available in the following cases:
 - When using [Impressive Art]/[Toy Effect]/[Toy Pop] in [Filter Settings]
 - When using [Panorama Shot]
 - When [HDR] is set to [ON]
 - When using [Multi Exp.]
 - When [iHandheld Night Shot] is set to [ON]
 - When [iHDR] is set to [ON]
 - When [Quality] is set to [RAW₁₁₁], [RAW₁₂], or [RAW]

[Digital Zoom]**Applicable modes:**   **P A S M**

Although the image quality deteriorates every time you zoom in further, you can zoom in up to four times the original zoom magnification.

MENU →  **[Rec]/**  **[Motion Picture]** → **[Digital Zoom]****Settings: [ON]/[OFF]**

- When using the [i.Zoom], the maximum magnification of the Digital Zoom is limited to 2×.
- When using the Digital Zoom, we recommend using a tripod and the self-timer for taking pictures.
- In the Digital Zoom range, the AF area is displayed at the centre in a larger size.

 **Not available in these cases:**

- This function is not available in the following cases:
 - When **[Monitor Display Speed]** is set to **[ECO30fps]** (setting at the time of purchase)
 - When [LVF Display Speed] is set to [ECO30fps]
 - When using [Impressive Art]/[Toy Effect]/[Toy Pop]/[Miniature Effect] in [Filter Settings]
 - When [Quality] is set to [RAW_{4:4:4}], [RAW_{4:2:0}] or [RAW]
 - When recording with the Post Focus function
 - When using [Panorama Shot]
 - When [HDR] is set to [ON]
 - When using [Multi Exp.]

[Step Zoom]

You can set the zoom operation to allow easy visualisation of the angle of view (picture angle) for the focal length of a regular fixed focal length lens (as with a 35 mm film camera). When using the [Step Zoom], you can operate the zoom ratio as easily as changing the camera lens.

- By default you can use Step Zoom by rotating the control ring in the following Recording Modes:

- Intelligent Auto Mode
- Programme AE Mode
- Aperture-Priority AE Mode

(A) Current zoom position (focal lengths equivalent to those of a 35 mm film camera)

- If you change the [Control Ring] setting in the [Custom] ([Operation]) menu to [Step Zoom], Step Zoom becomes available for other modes as well. (P55)

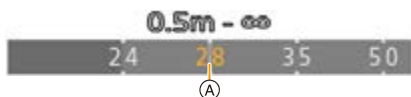
**■ Using the zoom lever for [Step Zoom]**

You can use Step Zoom by setting [Zoom lever] in the [Custom] ([Operation]) menu to [Step Zoom]. (P191)

⊘ Not available in these cases:

- Step Zoom cannot be operated with the control ring during Manual Focus.
- This function is not available in the following cases:
 - During motion picture recording
 - When recording with [4K Pre-Burst]
 - When using [Panorama Shot]

Zooming using touch operations (Touch zoom)

1 Touch [].

2 Touch [].

- The slide bar is displayed.



3 Perform zoom operations by dragging the slide bar.

- The zoom speed varies depending on the touched position.

[]/[]	Zooms slowly
[]/[]	Zooms quickly

- To end touch zoom operations, touch [] again.

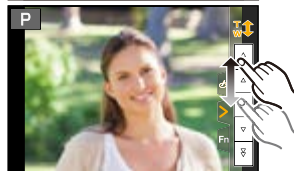

Taking pictures using the flash (supplied)

Applicable modes: **[A]** **[Av]** **[P]** **[A]** **[S]** **[M]**

You can attach a flash (supplied, DMW-FL580L/DMW-FL360L/DMW-FL200L: optional) and take pictures with it.

- This section uses the flash (supplied) to provide instructions.
- For details about how to attach external flashes other than the supplied flash, refer to their operating instructions.

Attaching the flash

■ Removing the Hot Shoe Cover

The camera comes with a hot shoe cover attached to the hot shoe.

Remove the hot shoe cover by pulling it in the direction indicated by arrow ② while pressing it in the direction indicated by arrow ①.

- Be sure to attach the hot shoe cover when the hot shoe is not in use.
- Keep the hot shoe cover safely after removing it so that you do not lose it.
- Keep the hot shoe cover out of reach of children to prevent swallowing.

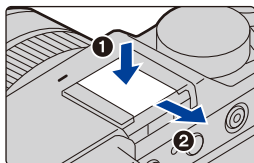

■ Attaching the flash

- 1 Set the on/off switches of the camera and flash to [OFF].**
- 2 Firmly insert the flash into the hot shoe of this unit until it clicks. (A)**

- When recording, set the on/off switches of the camera and flash to [ON].

- (A) Hot shoe
- (B) Flash [ON/OFF] switch
- (C) Lock release button

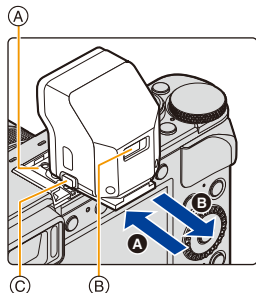

■ Removing the flash

- 1 Turn off the camera and the flash.**
- 2 Press and hold the lock release button and pull the flash in the direction indicated by the arrow to detach the flash. (B)**
 - When detaching the flash, do so slowly and carefully.
 - Attach the hot shoe cover to the hot shoe of the camera.
 - Store the detached flash in its soft case.

**In the following cases, the flash is fixed to [☹] ([Forced Flash Off]).**

- When recording motion pictures
- When recording 4K photos
- When recording with the Post Focus function
- When using [Panorama Shot]
- When using the electronic shutter
- When an image effect in [Filter Effect] of [Filter Settings] is set
- When [Silent Mode] is set to [ON]
- When [HDR] is set to [ON]

**When using other commercially available external flashes without communication functions with the camera**

- Set the exposure on the external flash.
- Set the Recording Mode to Aperture-Priority AE Mode or Manual Exposure Mode. Set the same aperture value and ISO sensitivity setting on the camera and the external flash.

■ The available flash range when [Sensitivity] setting is [AUTO]

Edges of picture may become slightly dark if using flash at short distances without using zoom (close to max. Wide). This may be remedied by using a little zoom.

Max. Wide	Max. Tele
Approx. 60 cm (2.0 feet) to 14.1 m (46 feet)*	Approx. 30 cm (0.98 feet) to 8.5 m (28 feet)*

* When the flash (supplied) is attached, [Sensitivity] is set to [AUTO], and [ISO Auto Upper Limit (Photo)] is set to [AUTO]

- You can set the aperture value, the shutter speed and the ISO sensitivity on the camera even when attaching the external flash.
- If you record at close range with a wide angle, light from the flash may be blocked by the lens, darkening the lower part of the screen.
- It may take time to charge the flash if you repeatedly take pictures. You must wait a moment to take the next picture while the flash icon is blinking red indicating the flash is charging.
- Do not bring any objects near the flash. The heat and light from the flash may cause the objects to deform or discolour.
- Do not use commercially available external flashes with high-voltage synchro terminals, reverse polarity or functions that enable them to communicate with the camera. Doing so may cause the camera to malfunction or operate incorrectly.
- When attaching the external flash, do not hold only the external flash because it may detach from the camera.
- Read the operating instructions of the external flash for details.

Setting the Flash Functions

- [Flash] in the [Rec] menu is available only when an external flash is attached.

Changing the firing mode

Applicable modes:   **P** **A** **S** **M**

Select whether to set the flash output automatically or manually.

- You can set the firing mode when using the flash (supplied).

1 Select the menu.

MENU →  [Rec] → [Flash] → [Firing Mode]	
[TTL]	The camera automatically sets the flash output.
[MANUAL]	Set the luminosity ratio of the flash manually. In [TTL] you can shoot the photograph you want even when shooting dark scenes that may otherwise be too brightly lit by the flash. <ul style="list-style-type: none"> • When [MANUAL] is set, the luminosity ratio ([1/1], etc.) is displayed on the flash icon on the screen.

2 (When [MANUAL] is selected)

Select the menu.

MENU →  [Rec] → [Flash] → [Manual Flash Adjust.]

3 Press ◀/▶ to set the luminosity ratio and then press [MENU/SET].

Changing Flash Mode

Applicable modes: **P** **A** **S** **M**

Set the flash to match the recording.

MENU → [Rec] → [Flash] → [Flash Mode]

([Forced Flash On]) ([Forced On/Red-Eye])*	<p>The flash is activated every time regardless of the recording conditions.</p> <ul style="list-style-type: none"> • Use this when your subject is back-lit or under fluorescent light.
([Slow Sync.]) ([Slow Sync./Red-Eye])*	<p>When taking pictures against a dark background landscape, this feature will slow the shutter speed when the flash is activated. Dark background landscape will appear brighter.</p> <ul style="list-style-type: none"> • Use this when you take pictures of people in front of a dark background. • Using a slower speed can cause motion blur. Using a tripod can enhance your photos.
([Forced Flash Off])	<p>The flash is not activated in any recording conditions.</p> <ul style="list-style-type: none"> • Use this when you take pictures in places where the use of flash is not permitted.

* Set [Flash] to the following settings:

– [Wireless]: [OFF]

– [Firing Mode]: [TTL]

• In Intelligent Auto Plus Mode, [] or [] can be set.

• Some flash modes may not be available depending on the external flash's settings.

The flash is activated twice.

The interval between the first and second flash is longer when [] or [] is set. The subject should not move until the second flash is activated.

• The Red-Eye Reduction effect differs between people. Also, if the subject was far away from the camera or was not looking at the first flash, the effect may not be evident.

■ Available flash settings by Recording Mode

The available flash settings depend on the Recording Mode.

(○: Available, —: Not available)

Recording Mode						
P	Programme AE Mode	○	○	○	○	○
A	Aperture-Priority AE Mode	○	○	○	○	○
S	Shutter-Priority AE Mode	○	○	—	—	○
M	Manual Exposure Mode	○	○	—	—	○

• In Intelligent Auto Mode (or), the flash will be set to [] or [].

■ Shutter speed for each flash setting

Flash setting	Shutter speed (Sec.)	Flash setting	Shutter speed (Sec.)
	1/60* to 1/4000		1 to 1/4000

* This becomes 60 seconds in Shutter-Priority AE Mode and [T] (Time) in the Manual Exposure Mode.

- In Intelligent Auto (or) Mode, shutter speed changes depending on the identified scene.

Setting to the 2nd Curtain Synchro

Applicable modes: **P A S M**

2nd curtain synchro activates the flash just before the shutter closes when taking pictures of moving objects such as cars using a slow shutter speed.

- Preparation: Set [Wireless] in [Flash] to [OFF].

MENU → [Rec] → [Flash] → [Flash Synchro]

[1ST]	1st curtain synchro The normal method when taking pictures with the flash.	
[2ND]	2nd curtain synchro The light source appears behind the subject and picture becomes dynamic.	

- [2nd] is displayed in the flash icon on the screen if you set [Flash Synchro] to [2ND].
- When a fast shutter speed is set, the effect of [Flash Synchro] may deteriorate.
- You cannot set [] or [] when [Flash Synchro] is set to [2ND].

Adjust the flash output

Applicable modes:   **P** **A** **S** **M**

Adjust the flash brightness when pictures taken with the flash are over or underexposed. Preparation: Set [Wireless] and [Firing Mode] in [Flash] to [OFF] and [TTL], respectively.

1 Select the menu.

MENU →  [Rec] → [Flash] → [Flash Adjust.]

2 Press **◀/▶** to set the flash output and then press **[MENU/SET]**.

- You can adjust from [-3 EV] to [+3 EV] in steps of 1/3 EV.
- Select [± 0] to return to the original flash output.

• [+] or [-] is displayed on the flash icon in the screen when the flash level is adjusted.

Synchronising the output of the flash to the Exposure Compensation

Applicable modes:   **P** **A** **S** **M**

The flash output is automatically adjusted in accordance with the exposure compensation value.

MENU →  [Rec] → [Flash] → [Auto Exposure Comp.]

Settings: [ON]/[OFF]

• For details on Exposure Compensation, refer to [P91](#).

Taking Pictures with Wireless Flashes

Applicable modes:  P A S M

Flashes compatible with this camera (DMW-FL580L/DMW-FL360L/DMW-FL200L: optional) come with the wireless recording function.

With this function, you can separately control the firing of three flash groups and the flash attached to the hot shoe of the camera.

The flash (supplied) does not support the wireless recording function, but it can be attached to the hot shoe of the camera to control the firing of the wireless flashes.

Placing wireless flashes

Place the wireless flash with its wireless sensor facing toward the camera.

The following figure shows the estimated controllable range when you take pictures by holding the camera horizontally. Controllable range differs depending on the surrounding environment.

Placement range (when a flash (supplied) is attached)

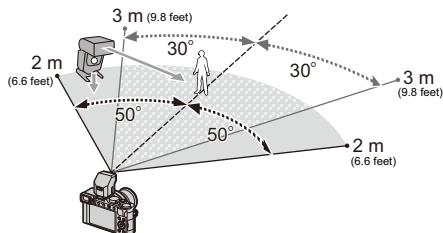

Placement example

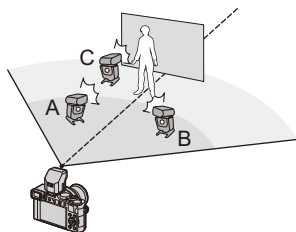

- In this placement example, flash C is placed to erase the shadow of the subject that flashes A and B will create.
- The recommended number of wireless flashes for each group is three or less.
- If the subject is too close, signal flashing may affect the exposure.

If you set [Communication Light] to [LOW] or lower the output with a diffuser or similar product, the effect will be reduced.

- 1 Attach the flash to the camera.**
- 2 Set the wireless flashes to RC Mode and then place them.**

- Set a channel and groups for the wireless flash.

3 Select the menu.

MENU → [Rec] → [Flash]	
[Wireless]	Select [ON].
[Wireless Channel]	Select the channel you have set for the wireless flashes in step 2.
[Wireless Setup]	Proceed to step 4.

4 Press ▲/▼ to select an item and then press [MENU/SET].

• To fire a test flash, press [DISP].

- (A) Firing Mode
- (B) Flash output
- (C) Luminosity ratio



[External Flash]	[Firing Mode] [TTL]: The camera automatically sets the output. [AUTO]*1: Flash output is set by the external flash. [MANUAL]: Set the luminosity ratio of the external flash manually. [OFF]: The flash on the camera side emits only communication light.
	[Flash Adjust.] Set the flash output of the camera manually when [Firing Mode] is set to [TTL].
	[Manual Flash Adjust.] Set the luminosity ratio of the external flash when [Firing Mode] is set to [MANUAL]. • You can set from [1/1] (full brightness) to [1/128]*2 in steps of 1/3.
[A Group]/ [B Group]/ [C Group]	[Firing Mode] [TTL]: The camera automatically sets the output. [AUTO]: The wireless flashes automatically set the output. [MANUAL]: Set the luminosity ratio of the wireless flashes manually. [OFF]: The wireless flashes of the specified group will not fire.
	[Flash Adjust.] Adjust the output of the wireless flashes manually when [Firing Mode] is set to [TTL].
	[Manual Flash Adjust.] Set the luminosity ratio of the wireless flashes when [Firing Mode] is set to [MANUAL]. • You can set from [1/1] (full brightness) to [1/128] in steps of 1/3.

*1 It cannot be set when the flash (supplied, DMW-FL200L: optional) is attached to the camera.

*2 When the flash (supplied) is attached to the camera, the setting can be adjusted up to [1/64].

Setting the output of communication light

MENU →  [Rec] → [Flash] → [Communication Light]

Settings: [HIGH]/[STANDARD]/[LOW]



MENU



Recording Motion Picture

Applicable modes: **[A] [AF] [P] [A] [S] [M]**

This camera can record full high definition motion pictures compatible with the AVCHD format or motion pictures recorded in MP4. In addition, the camera can record 4K motion pictures in MP4.

Audio will be recorded in stereo.

- You can record motion pictures by manually setting the aperture value and shutter speed. (P64)
- The camera automatically sets the aperture value and shutter speed and identifies the optimal scene to record motion pictures in Intelligent Auto Mode. (P57)

1 Start recording by pressing the motion picture button.

- (A) Elapsed recording time
- (B) Available recording time

- The recording state indicator (red) (C) will flash while recording motion pictures.
- Release the motion picture button right after you press it.
- m: minute, s: second

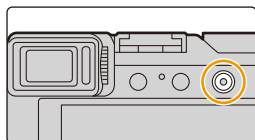

2 Stop the recording by pressing the motion picture button again.

- **With recording in a quiet environment, the sound of aperture and focus may be recorded in motion pictures.**

This is not a malfunction. The focus operation during recording of motion pictures can be set to [OFF] in [Continuous AF] (P160).

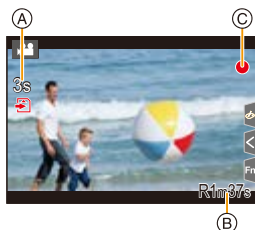

If the operation sound of the motion picture button pressed to end recording bothers you, try the following:

- Record the motion picture about three seconds longer, and then divide the last part of the motion picture using [Video Divide] in the [Playback] menu.

Recording motion pictures with reduced operational sounds

Applicable modes:

When you operate the zoom, buttons, etc. while recording motion pictures, the sounds associated with such operations may be recorded. Using touch operations allows silent operation.

1 Touch [] while recording a motion picture.

2 Touch the desired icon.

: Zoom

ISO : ISO sensitivity

: Exposure compensation*

: Sound recording level adjustment

* It is displayed when [Exposure Comp.] is set in a function button. (P50)

3 Drag the slide bar to adjust the setting.

[]/[]: Adjusts the setting slowly

[]/[]: Adjusts the setting quickly

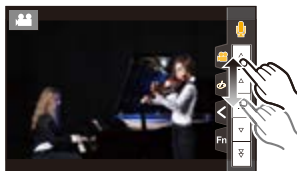

- When the ambient temperature is high or a motion picture is recorded continuously, the camera may display [] and then stop the recording. Wait until the camera cools down.
- When the aspect ratio setting is different in still and motion pictures, the angle of view changes at the start of motion picture recording.
When [Rec Area] in the [Custom] menu ([Monitor / Display]) is set to [], angle of view during motion picture recording is displayed.
- If the Extra Optical Zoom are used before pressing the motion picture button, those settings will be cleared, so the angle of view will change dramatically.
- The operational sound of the zoom or button operation may be recorded when it is operated during the recording of a motion picture.
- The zoom speed decreases during the recording of a motion picture.
- Depending on the type of the card, the card access indication may appear for a while after recording motion pictures. This is not a malfunction.

Not available in these cases:

- Motion pictures cannot be recorded in the following cases.
 - When using [Rough Monochrome]/[Silky Monochrome]/[Soft Focus]/[Star Filter]/[Sunshine] in [Filter Settings]
 - When recording with the Post Focus function
 - When using [Panorama Shot]
 - When taking pictures with [Time Lapse Shot]
 - When using [Stop Motion Animation]

Setting the recording format and recording quality

1 Select the menu.

MENU →  **[Motion Picture]** → **[Rec Format]**

[AVCHD]	This data format is suitable for when playing back on a high-definition TV, etc.
[MP4]	This data format is suitable for when playing back on a PC, etc.

2 Press ▲/▼ to select **[Rec Quality]** and then press **[MENU/SET]**.

When **[AVCHD]** is selected

Item	Size	Recording frame rate	Sensor output	Bit rate
[FHD/28M/50p]⁺¹	1920×1080	50p	50 frames/second	28 Mbps
[FHD/17M/50i]	1920×1080	50i	50 frames/second	17 Mbps
[FHD/24M/25p]	1920×1080	50i	25 frames/second	24 Mbps
[FHD/24M/24p]	1920×1080	24p	24 frames/second	24 Mbps

*1 AVCHD Progressive

When **[MP4]** is selected

Item	Size	Recording frame rate	Sensor output	Bit rate
[4K/100M/30p]⁺²	3840×2160	30p	30 frames/second	100 Mbps
[4K/100M/25p]⁺²	3840×2160	25p	25 frames/second	100 Mbps
[4K/100M/24p]⁺²	3840×2160	24p	24 frames/second	100 Mbps
[FHD/28M/60p]	1920×1080	60p	60 frames/second	28 Mbps
[FHD/28M/50p]	1920×1080	50p	50 frames/second	28 Mbps
[FHD/20M/30p]	1920×1080	30p	30 frames/second	20 Mbps
[FHD/20M/25p]	1920×1080	25p	25 frames/second	20 Mbps
[HD/10M/30p]	1280×720	30p	30 frames/second	10 Mbps
[HD/10M/25p]	1280×720	25p	25 frames/second	10 Mbps

*2 4K motion pictures

- The higher the Bit rate value is, the higher the picture quality becomes. Since the camera employs the VBR recording method, the bit rate is changed automatically depending on the subject to record. As a result, the recording time is shortened when a fast-moving subject is recorded.
- 4K motion picture settings are not available for [Miniature Effect] in [Filter Settings].
- When recording motion pictures in 4K, use a card rated as UHS Speed Class 3.
- When you record 4K motion pictures, the angle of view will be narrower than motion pictures of other sizes.
- To ensure highly accurate focus, 4K motion pictures are recorded at reduced Auto Focus speeds. It may be difficult to focus on the subject with Auto Focus, but this is not a malfunction.
- Refer to [P31](#) for information about continuous recordable times.

■ About the compatibility of the recorded motion pictures

Motion pictures in AVCHD and MP4 formats may not be played back even on devices that support these formats. In other cases, the motion pictures may be played back with poor image or sound quality or their recording information may not be displayed correctly. In these cases, play them back on the camera.

- To play back or import motion pictures in AVCHD format using another device, use a Blu-ray disc recorder that supports the format or a PC installed with the software "PHOTOfunSTUDIO".
- For details about 4K motion pictures recorded with the camera, refer to "Watching/Saving 4K Motion Pictures on an External Device" on [P271](#).

How to set focus when recording a motion picture ([Continuous AF])

Applicable modes:   **P** **A** **S** **M**

Focusing changes depending on the Focus Mode setting and the [Continuous AF] setting in the [Motion Picture] menu.

MENU →  **[Motion Picture]** → **[Continuous AF]**

Focus mode	[Continuous AF]	Description of settings
[AFS]/[AFF]/ [AFC]	[ON]	The camera automatically keeps focusing on subjects during recording.
	[OFF]	The camera maintains the focus position at the start of recording.
[MF]	[ON]/[OFF]	You can focus manually.

- When the focus mode is set to [AFS], [AFF] or [AFC], if you press the shutter button halfway while recording a motion picture, the camera will re-adjust the focus.
- Operational sound may be recorded when Auto Focus is operated while recording a motion picture. We recommend setting [Continuous AF] to [OFF] to suppress the sound.
- When operating the zoom while recording motion pictures, it may take time to come into focus.

Recording still pictures while recording motion pictures

Applicable modes:   P A S M

You can record still pictures while recording a motion picture. (Simultaneous recording)

During motion picture recording, press the shutter button fully to record a still picture.



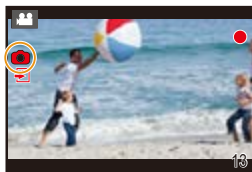

- Simultaneous recording indicator is displayed while recording still pictures.
- Recording with the Touch Shutter function is also available.



■ Setting the motion picture priority or still picture priority mode

Applicable modes:   P A S M

MENU →  **[Motion Picture]** → **[Picture Mode in Rec.]**

 ([Video Priority])	<ul style="list-style-type: none"> • Pictures will be recorded with a picture size determined by the [Rec Quality] setting for motion pictures. • Only JPEG images are recorded when [Quality] is set to [RAW , [RAW ] or [RAW]. (When set to [RAW], still pictures will be recorded in [Quality] of ) • You can take up to 40 still pictures. (Up to 10 still pictures during 4K motion picture recording)
 ([Photo Priority])	<ul style="list-style-type: none"> • Pictures will be recorded with the set picture size and quality. • The screen will go dark while recording pictures. A still picture will be recorded in the motion picture during that period, and audio is not recorded. • You can take up to 10 still pictures. (Up to 5 still pictures during 4K motion picture recording)

- The picture aspect ratio will be fixed to [16:9].



Not available in these cases:

- When [] ([Photo Priority]) is set, simultaneous recording is not possible in the following cases:
 - When [Rec Quality] is set to [4K/100M/24p]
 - When the drive mode is set to 4K Photo

Displaying/setting the sound input level

[Sound Rec Level Disp.]

Applicable modes:   P A S M

The sound recording level is displayed on the recording screen.

MENU →  [Motion Picture] → [Sound Rec Level Disp.]

Settings: [ON]/[OFF]

Not available in these cases:

- [Sound Rec Level Disp.] is fixed to [OFF] in the following case:
 - When using [Miniature Effect] in [Filter Settings]

[Sound Rec Level Adj.]

Applicable modes:   P A S M

Adjust the sound input level to 4 different levels (–12 dB to +6 dB).

MENU →  [Motion Picture] → [Sound Rec Level Adj.]

- Displayed dB values are approximate.

Not available in these cases:

- [Sound Rec Level Adj.] does not work in the following case:
 - When using [Miniature Effect] in [Filter Settings]

Playing Back Pictures

1 Press [▶].

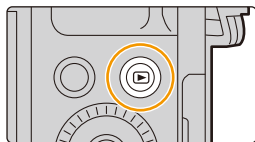

2 Press ◀/▶.

◀: Play back the previous picture

▶: Play back the next picture

- If you press and hold ◀/▶, you can play back the pictures in succession.
- Pictures can also be forwarded or rewound by rotating the control dial or dragging the screen horizontally.
- You can forward or rewind pictures continuously by keeping your finger on the left or right sides of the screen after forwarding/rewinding a picture.



Sending an image to a web service

If you press ▼ when displaying images one by one, you can easily send an image to a web service. (P258)

■ To finish playback

Press [▶] again or press the shutter button halfway.

- The playback screen is displayed if you set the camera on/off switch to [ON] while pressing and holding [▶].
- When [Lens Retraction] in the [Custom] ([Lens / Others]) menu is set to [ON], the lens barrel will retract approx. 15 seconds after switching from the recording screen to the playback screen.

Not available in these cases:

- This camera complies with the DCF standard “Design rule for Camera File system” established by JEITA “Japan Electronics and Information Technology Industries Association” and with Exif “Exchangeable Image File Format”.
This camera can only display pictures that comply with the DCF standard.
- The camera may not play back images recorded on other devices correctly, and the functions of the camera may not be available for the images.

Playing Back Motion Pictures

This unit was designed to play motion pictures using the AVCHD and MP4 formats.

Select an icon indicated with [A], and then press **▲** to play it back.

(A) Motion picture recording time

- After playback starts, the elapsed playback time is displayed on the screen.

For example, 8 minutes and 30 seconds is displayed as [8m30s].

- Some information (recording information, etc.) is not displayed for motion pictures recorded in [AVCHD].

- Touching [▶] in the middle of the screen allows you to play back motion pictures.



■ Operations during Motion Picture Playback

Button operation	Touch operation	Description of operation	Button operation	Touch operation	Description of operation
▲	▶/	Play/Pause	▼	■	Stop
◀	◀◀	Fast rewind*1	▶	▶▶	Fast forward*1
	◀	Frame-by-frame rewind (while pausing)*2		▶	Frame-by-frame forward (while pausing)
(🔊)	-	Reduce volume level	(🔊)	+	Increase volume level

*1 The fast forward/rewind speed increases if you press ▶/◀ again.

*2 When a motion picture recorded with [AVCHD] is rewound frame-by-frame, its frames will be shown in intervals of approximately 0.5 seconds.

• You can play back motion pictures on a PC with "PHOTOfunSTUDIO".

Creating Still Pictures from a Motion Picture

1 Press **▲** to pause motion picture playback.

- Press **◀▶** to fine-adjust the pause position while the motion picture is paused.

2 Press **[MENU/SET]**.

- The same operation can be performed by touching **[◀▶]**.



- Still pictures will be saved with aspect ratio set to [16:9] and [Quality] set to **[📺]**.
The number of pixels will differ according to the motion picture you play back.

[Rec Quality]	[Picture Size]
[4K]	[M] (8M)
[FHD]/[HD]	[S] (2M)

- Still pictures created from a motion picture may be coarser than with normal picture quality.
- **[📺]** is displayed during playback of still pictures created from motion pictures.

Switching the Playback Method

Using the Playback Zoom

Move the zoom lever toward [T] side.

1× → 2× → 4× → 8× → 16×



Button operation	Touch operation	Description of operation
	—	Enlarges/reduces the screen.
—	Pinching out/in	Enlarges/reduces the screen in small steps.
▲/▼/◀/▶	Dragging	Moves the enlarged area (during enlarged display).
	—	Forwards or rewinds the image while maintaining the same zoom magnification and zoom position (during enlarged display).

- Touch the screen twice to switch between the enlarged display and normal display.

Displaying multiple screens (Multi Playback)

Move the zoom lever toward [W] side.

1 screen → 12 screens → 30 screens → Calendar display

- Rotate the zoom lever to the [T] side to return to the previous display mode.

- You can also switch the playback screen by touching the following icons:

- [1]: 1 screen
- [12]: 12 screens
- [30]: 30 screens
- [CAL]: Calendar screen display

- You can also scroll the list display by dragging the screen up/down.

- Pictures displayed using [!] cannot be played back.

■ To return to Normal Playback

Press ▲/▼/◀/▶ to select a picture and then press [MENU/SET].

- If you select a motion picture, it will be played back automatically.

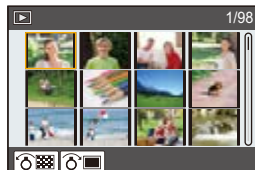

Displaying Pictures by Recording Date (Calendar Playback)

1 Rotate the zoom lever to the [W] side to display the Calendar display.

2 Press ▲/▼/◀/▶ to select the recording date and press [MENU/SET].

- Only the images recorded on that date will be displayed.
- To return to the Calendar display, rotate the zoom lever to the [W] side.

3 Press ▲/▼/◀/▶ to select a picture and then press [MENU/SET].



- The recording date of the picture selected in the playback screen becomes the date selected when the Calendar screen is first displayed.

- You can display the Calendar between January 2000 and December 2099.

- If the date is not set in the camera, the recording date is set as the 1st January, 2018.

- If you take pictures after setting the travel destination in [World Time], the pictures are displayed by the dates at the travel destination in Calendar Playback.

Playing Back Group Pictures

A picture group consists of multiple pictures. You can play back pictures in a group either continuously or one by one.

- You can edit or delete all pictures in a group at once.
(For example, if you delete a picture group, all pictures in the group are deleted.)



A picture group saved at once with [4K PHOTO Bulk Saving].



A picture group consisting of pictures taken with Focus Bracket.



A picture group consisting of pictures taken in a Time Lapse Shot.



A picture group consisting of pictures taken in the Stop Motion Animation.

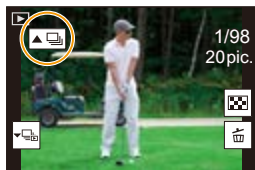

- Pictures will not be grouped if recorded without setting the clock.

■ Continuously playing back Group Pictures

Press ▲.

- The same operation can be performed by touching the group picture icon ([▲🖼️]), ([▲📷]), ([▲📷📷]).
- When playing back group pictures one at a time, options are displayed. After selecting [Burst Play] (or [Sequential Play]), select either of the following playback methods:
 - [From the first picture]:
Pictures are played back continuously from the first picture of the group.
 - [From the current picture]:
Pictures are played back continuously from the picture being played back.
- Operations during continuous playback

Button operation	Touch operation	Description of operation
▲	▶/	Continuous playback/Pause
◀	◀◀	Fast rewind
	◀◀	Rewind (while pausing)

Button operation	Touch operation	Description of operation
▼	■	Stop
▶	▶▶	Fast forward
	▶▶	Forward (while pausing)

■ Playing back group pictures one by one

1 Press ▼.

- The same operation can be performed by touching [▼🖼️], [▼📷], [▼📷📷].

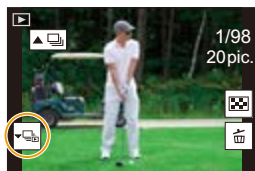

2 Press ◀/▶ to flip through images.

- To return to the normal playback screen, press ▼ again or touch [▼🖼️].
- Each picture in a group can be treated same as normal pictures when they are played back. (Such as Multi Playback, Playback Zoom and deleting images)

Deleting Pictures

Once deleted, pictures cannot be recovered.

■ To delete a single picture

- 1 In Playback Mode, select the picture to delete and then press [].

- The same operation can be performed by touching [].

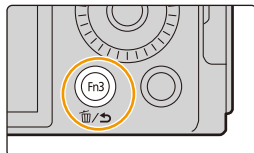

- 2 Press $\blacktriangle/\blacktriangledown$ to select [Delete Single] and then press [MENU/SET].

■ To delete multiple pictures (up to 100) or all the pictures

- Picture groups are treated as a single picture. (All the pictures in the selected picture group will be deleted.)

- 1 In Playback Mode, press [].

- 2 Press $\blacktriangle/\blacktriangledown$ to select [Delete Multi] or [Delete All] and then press [MENU/SET].

- After selecting [Delete All], if you select [Delete All Non-rating], you can delete all pictures except for those with ratings.

(When [Delete Multi] is selected)

- 3 Press $\blacktriangle/\blacktriangledown/\blacktriangleleft/\blacktriangleright$ to select the picture, and then press [MENU/SET]. (Repeat this step.)

(A)  Picture selected

- To cancel the selection, press [MENU/SET] again.

- 4 Press [DISP.] to execute.



- Depending on the number of pictures to be deleted, it may take some time to delete them.

10. Using Menu Functions

Menu list

[Intelligent Auto] menu	P171	(A)
[Rec] menu	P171	(B)
[Motion Picture] menu	P184	
[Custom] menu	P185	
[Setup] menu	P200	
[My Menu] menu	P209	
[Playback] menu	P210	

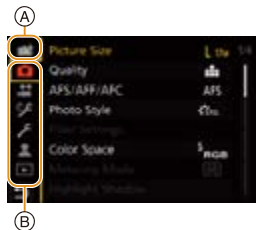

: [Intelligent Auto] menu

- [Intelligent Auto Mode] (P58)
- [iHDR] (P60)
- [iHandheld Night Shot] (P60)

: [Rec] menu

- [Picture Size] (P172)
- [Quality] (P173)
- [AFS/AFF/AFC] (P75)
- [Photo Style] (P174)
- [Filter Settings] (P123)
- [Color Space] (P176)
- [Metering Mode] (P176)
- [Highlight Shadow] (P177)
- [i.Dynamic] (P178)
- [i.Resolution] (P178)
- [Flash] (P150)
- [Red-Eye Removal] (P178)
- [ISO Auto Upper Limit (Photo)] (P179)
- [Min. Shtr Speed] (P179)
- [Long Shtr NR] (P179)
- [Diffraction Compensation] (P180)
- [Stabilizer] (P140)
- [i.Zoom] (P143)
- [Digital Zoom] (P144)
- [Burst Rate] (P99)
- [4K PHOTO] (P101)
- [Self Timer] (P116)
- [Time Lapse Shot] (P134)
- [Stop Motion Animation] (P137)
- [Panorama Settings] (P120)
- [Silent Mode] (P180)
- [Shutter Type] (P181)
- [Bracket] (P130)
- [HDR] (P182)
- [Multi Exp.] (P183)

[Picture Size]

Applicable modes:  P A S M

The higher the numbers of pixels, the finer the detail of the pictures will appear even when they are printed onto large sheets.

MENU →  **[Rec]** → **[Picture Size]**

Aspect ratio	[4:3]	[1:1]	[16:9]	[3:2]
[Picture Size]	[L] (17M) 4736×3552	[L] (12.5M) 3552×3552	[L] (15M) 5152×2904	[L] (16M) 4928×3288
	[EXM] (8.5M) 3360×2520	[EXM] (6.5M) 2528×2528	[EXM] (8M) 3840×2160	[EXM] (8M) 3504×2336
	[EXS] (4M) 2368×1776	[EXS] (3M) 1776×1776	[EXS] (2M) 1920×1080	[EXS] (4M) 2496×1664

 **Not available in these cases:**







- [Picture Size] cannot be set in the following cases:
 - When using [Panorama Shot]
 - When recording 4K photos
 - When recording with the Post Focus function

[Quality]

Applicable modes:     

Set the compression rate at which the pictures are to be stored.



MENU →  **[Rec]** → **[Quality]**

Settings	File format	Description of settings
	JPEG	A JPEG image in which image quality was given priority.
		A standard image quality JPEG image. This is useful for increasing the number of shots without changing the number of pixels.
	RAW+JPEG	You can record a RAW image and a JPEG image ( or ) simultaneously.
		
	RAW	You can only record RAW images.

**About RAW**

RAW format refers to a data format of images that have not been processed. Playback and editing of RAW images require the camera or the dedicated software.

- You can process RAW images in [RAW Processing] in the [Playback] menu. (P215)
- Use software (“SILKYPIX Developer Studio” by Ichikawa Soft Laboratory) to process and edit RAW files on a PC.

- When you delete an image recorded with  or , both the RAW and JPEG images will be deleted simultaneously.
- When you play back an image recorded with [RAW], grey areas corresponding to the aspect ratio at the time of recording are displayed.
- The setting is fixed to  when recording is performed with the 4K Photo or Post Focus function.

**Not available in these cases:**









- You cannot set to ,  or [RAW] in the following case:
 - When using [Panorama Shot]

[Photo Style]

Applicable modes:   **P** **A** **S** **M**

You can select effects to match the type of image you wish to record.

MENU →  **[Rec]/**  **[Motion Picture]** → **[Photo Style]**

 STD. [Standard]	This is the standard setting.
 VIVID [Vivid]	Brilliant effect with high saturation and contrast.
 NAT [Natural]	Soft effect with low contrast.
 MONO [Monochrome]	Monochrome effect with no colour shades.
 L.MONO [L.Monochrome]	Black-and-white effect with rich gradation and crisp black accents.
 L.MONO D [L.Monochrome D]	Monochrome effect that creates a dynamic impression with enhanced highlights and shadows.
 SCNY [Scenery]	An effect appropriate for sceneries with vivid blue skies and greens.
 PORT [Portrait]	An effect appropriate for portraits with a healthy and beautiful skin tone.
 CUST [Custom]	This uses a setting registered in advance.

• In Intelligent Auto Plus Mode:

- Only [Standard] or [Monochrome] can be set.
- The setting will be reset to [Standard] when the camera is switched to another Recording Mode or this unit is turned off.

■ Adjusting the picture quality

- You cannot adjust the picture quality in Intelligent Auto Plus Mode.

- 1 Press **◀/▶** to select the type of Photo Style.
- 2 Press **▲/▼** to select the items, and then press **◀/▶** to adjust.

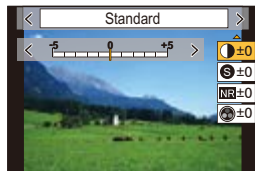

☾ [Contrast]	[+]	Increases the difference between the brightness and the darkness in the picture.
	[-]	Decreases the difference between the brightness and the darkness in the picture.
S [Sharpness]	[+]	The picture is sharply defined.
	[-]	The picture is softly focused.
NR [Noise Reduction]	[+]	The noise reduction effect is enhanced. Picture resolution may deteriorate slightly.
	[-]	The noise reduction effect is reduced. You can obtain pictures with higher resolution.
☉ [Saturation] ^{*1}	[+]	The colours in the picture become vivid.
	[-]	The colours in the picture become natural.
☉ [Color Tone] ^{*1}	[+]	Adds a bluish tone.
	[-]	Adds a yellowish tone.
🎛️ [Filter Effect] ^{*2}	[Yellow]	Enhances the contrast of an subject. (Effect: Weak) The blue sky can be recorded clearly.
	[Orange]	Enhances the contrast of an subject. (Effect: Medium) The blue sky can be recorded in darker blue.
	[Red]	Enhances the contrast of an subject. (Effect: Strong) The blue sky can be recorded in much darker blue.
	[Green]	The skin and lips of people appear in natural tones. Green leaves appear brighter and more enhanced.
	[Off]	—
🎛️ [Grain Effect] ^{*2}	[Low]/ [Standard]/ [High]	Sets the graininess in a picture.
	[Off]	—

*1 [Color Tone] is displayed only when [Monochrome], [L.Monochrome] or [L.Monochrome D] is selected. In other cases, [Saturation] will be displayed.

*2 Displayed only when [Monochrome], [L.Monochrome] or [L.Monochrome D] is selected.

- If you adjust the picture quality, [+] is displayed beside the Photo Style icon on the screen.

- 3 Press **[MENU/SET]**.

■ Registering settings to [Custom]

Press **[DISP.]** in step 2 of "Adjusting the picture quality".

- The effect of [Grain Effect] cannot be checked on the recording screen.
- [Grain Effect] is not available in the following cases.
 - Panorama Shot Mode
 - When recording motion pictures
 - When recording 4K photos
 - When recording with the Post Focus function

[Color Space]

Applicable modes: **P** **A** **S** **M**

This sets the method for reproducing the correct colours to output the recorded images to a PC screen or a device such as a printer.

MENU → **[Rec]** → **[Color Space]**

[sRGB]	Colour space is set to sRGB colour space. This is widely used in computer related equipment.
[AdobeRGB]	Colour space is set to AdobeRGB colour space. AdobeRGB is mainly used for business purposes such as professional printing because it has a greater range of reproducible colours than sRGB.

- Set to [sRGB] if you are not very familiar with AdobeRGB.
- The setting is fixed to [sRGB] in the following cases.
 - When recording motion pictures
 - When recording 4K photos
 - When recording with the Post Focus function

[Metering Mode]

Applicable modes: **P** **A** **S** **M**

Type of optical measurement to measure brightness can be changed.

MENU → **[Rec]**/ **[Motion Picture]** → **[Metering Mode]**

[Metering Mode]	Brightness measurement position	Conditions
(Multiple)	Whole screen	Normal usage (produces balanced pictures)
(Centre weighted)	Centre and surrounding area	Subject in centre
(Spot)	Centre of [+] (spot metering target A) 	Great difference between brightness of subject and background (e.g. person in spotlight on stage, backlighting)

- If you set the spot metering target on the edge of the screen, the metering may be affected by the brightness around the location.

[Highlight Shadow]

Applicable modes: **P** **A** **S** **M**

You can adjust the brightness of bright and dark portions on an image while checking the brightness on the screen.

MENU → **[Rec]/** **[Motion Picture]** → **[Highlight Shadow]**

<input type="checkbox"/> (Standard)	A state with no adjustments is set.
<input type="checkbox"/> (Raise the contrast)	Bright areas are brightened, and dark areas are darkened.
<input type="checkbox"/> (Lower the contrast)	Bright areas are darkened, and dark areas are brightened.
<input type="checkbox"/> (Brighten dark areas)	Dark areas are brightened.
<input type="checkbox"/> / <input type="checkbox"/> / <input type="checkbox"/> (Custom)	Registered custom settings can be applied.

1 Rotate the control ring to adjust the brightness of bright areas and rotate the control dial to adjust the brightness of dark areas.

- Ⓐ Bright portion
- Ⓑ Dark portion

- Adjustments can also be made by dragging the graph.
- To register a preferred setting, press **▲**, and select the destination where the custom setting will be registered to ([Custom1] ()/[Custom2] ()/[Custom3] ()).

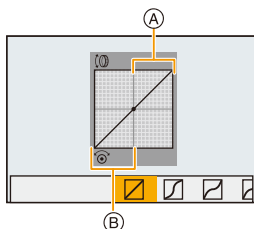

2 Press [MENU/SET].

- The screen display can be switched by pressing **[DISP.]** on the brightness adjustment screen.

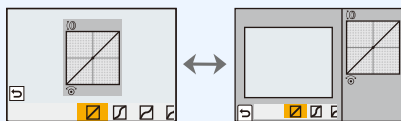

- Turning off this unit will return the setting adjusted with / / / back to the default setting.



Not available in these cases:

- **[Highlight Shadow]** cannot be set in the following cases:
 - When using **[Panorama Shot]**
 - When using **[Filter Settings]**

[i.Dynamic]**Applicable modes:**   **P A S M**

Contrast and exposure are compensated when the brightness difference between the background and subject is great, etc.

MENU →  **[Rec]/**  **[Motion Picture]** → **[i.Dynamic]****Settings:** **[AUTO]/[HIGH]/[STANDARD]/[LOW]/[OFF]** **Not available in these cases:**

- Compensation effect may not be achieved depending on the recording conditions.
- [i.Dynamic] does not work in the following cases:
 - When using [Panorama Shot]
 - When [HDR] is set to [ON]



[i.Resolution]**Applicable modes:**   **P A S M**



Pictures with sharp profile and resolution can be taken by using the Intelligent Resolution Technology.

MENU →  **[Rec]/**  **[Motion Picture]** → **[i.Resolution]****Settings:** **[HIGH]/[STANDARD]/[LOW]/[OFF]****[Red-Eye Removal]****Applicable modes:**   **P A S M**

If you fire the flash when using Red-Eye Reduction ([] or []), the camera automatically detects red-eye and corrects the picture.

MENU →  **[Rec]** → **[Red-Eye Removal]****Settings:** **[ON]/[OFF]**

- If you set this item to [ON], the icon will change to [] or [].
- Under certain circumstances, red-eye cannot be corrected.

[ISO Auto Upper Limit (Photo)]**Applicable modes:**   **P A S M**You can set the upper limit of ISO sensitivity when ISO sensitivity is set to [AUTO] or [ISO].**MENU** →  **[Rec]** → **[ISO Auto Upper Limit (Photo)]****Settings:** [AUTO]/[400]/[800]/[1600]/[3200]/[6400]/[12800]/[25600]**[Min. Shtr Speed]****Applicable modes:**   **P A S M**Set the minimum shutter speed when the ISO sensitivity is set to [AUTO] or [ISO].**MENU** →  **[Rec]** → **[Min. Shtr Speed]****Settings:** [AUTO]/[1/16000] to [1/1]

- The shutter speed may become slower than the set value in situations where proper exposure cannot be obtained.

 **Not available in these cases:**

- The desired compensation effect may not be achieved depending on the recording conditions.
- [Min. Shtr Speed] cannot be set in the following case:
 - When using [Panorama Shot]

[Long Shtr NR]**Applicable modes:**   **P A S M**

The camera automatically removes noise that appears when the shutter speed becomes slower to take pictures of night or similar scenery.

MENU →  **[Rec]** → **[Long Shtr NR]****Settings:** [ON]/[OFF]

- [Long shutter noise reduction ongoing] is displayed for the same time as the shutter speed for signal processing.

 **Not available in these cases:**

- This function is not available in the following cases:
 - When recording motion pictures
 - When recording 4K photos
 - When recording with the Post Focus function
 - When using [Panorama Shot]
 - When using the electronic shutter

[Diffraction Compensation]**Applicable modes:**   **P A S M**

The camera raises the resolution by correcting the blurriness caused by diffraction when the aperture is closed.



MENU →  **[Rec]** /  **[Motion Picture]** → **[Diffraction Compensation]****Settings: [AUTO]/[OFF]**

- Noise may stand out with higher ISO sensitivity.

[Silent Mode]**Applicable modes:**   **P A S M**

Disables operational sounds and output of light at once.

MENU →  **[Rec]** → **[Silent Mode]****Settings: [ON]/[OFF]**

- Audio from the speaker will be muted and the flash and the AF Assist lamp will be disabled. The following settings are fixed.
 - [Flash Mode]:  ([Forced Flash Off])
 - [Shutter Type]: [ESHTR]
 - [AF Assist Lamp]: [OFF]
 - [Beep Volume]:  (OFF)
 - [Shutter Vol.]:  (OFF)
- Even when [ON] is set, the following functions light up/flash.
 - WIRELESS connection lamp
 - Self-timer indicator
- The operation sounds of this camera such as the lens aperture sound are not muted.
- **Be sure to pay special attention to the privacy, the likeness rights, etc. of the subject when you use this function. Use at your own risk.**

[Shutter Type]

Applicable modes:   **P** **A** **S** **M**

Select the shutter to be used for taking pictures.

MENU →  **[Rec]** → **[Shutter Type]**

[AUTO]	Switches the shutter type automatically depending on the recording condition and shutter speed. • The mechanical shutter mode has higher priority over the electronic shutter mode because the mechanical shutter has less function-related restrictions when recording with a flash, etc.
[MSHTR]	Takes pictures in Mechanical Shutter Mode.
[ESHTR]	Takes pictures in Electronic Shutter Mode.

	Mechanical shutter	Electronic Shutter
Flash	○	—
Shutter Speed (Sec.)	[T] (Time) ^{*1} /60 to 1/4000	1 ^{*2} to 1/16000
Shutter sound	Mechanical shutter sound + Electronic shutter sound ^{*3}	Electronic shutter sound ¹⁺³

*1 This setting is available only in Manual Exposure Mode.

*2 Up to an ISO sensitivity of [ISO3200]. When the setting is higher than [ISO3200], the shutter speed will be faster than 1 second.

*3 Electronic shutter sound settings can be changed in [Shutter Vol.] and [Shutter Tone].

• Electronic Shutter Mode allows you to take pictures without causing shutter vibration.

- When [] is displayed on the screen, pictures will be taken with the electronic shutter.
- When **[ESHTR]** is set, if you take a picture of a moving subject, it may appear distorted in the picture.
- When **[ESHTR]** is set, horizontal stripes may appear on pictures taken under lighting such as a fluorescent or LED lighting fixture. The horizontal stripes may be reduced if you set a slower shutter speed.

[HDR]**Applicable modes:**  **P A S M**

You can combine 3 pictures with different levels of exposure into a single picture with rich gradation.

You can minimise the loss of gradations in bright areas and dark areas when, for example, the contrast between the background and the subject is large.

An image combined by HDR is recorded in JPEG.

MENU →  **[Rec]** → **[HDR]**

Settings: **[ON]/[OFF]/[SET]**



■ Changing settings

[Dynamic Range]	<p>[AUTO]: Automatically adjusts the exposure range according to the differences between the bright and dark areas.</p> <p>[±1 EV]/[±2 EV]/[±3 EV]: Adjusts the exposure within the selected exposure parameters.</p>
[Auto Align]	<p>[ON]: Automatically corrects camera shake (jitter) and other problems that can cause the images to misalign. Recommended for use during hand-held shooting.</p> <p>[OFF]: Image misalignment not adjusted. Recommended when a tripod is used.</p>

- Do not move the unit during the continuous shooting after pressing the shutter button.
- You cannot take the next picture until the combination of pictures is complete.
- A moving subject may be recorded with unnatural blurs.
- The angle of view becomes narrow slightly when [Auto Align] is set to [ON].
- Flash is fixed to  ([Forced Flash Off]).



Not available in these cases:

- [HDR] does not work for the pictures taken during a motion picture recording.
- This function is not available in the following cases:
 - When recording 4K photos
 - When recording with the Post Focus function
 - When recording in Burst Mode
 - When using [Panorama Shot]
 - When recording with the Bracket function
 - When [Quality] is set to ,  or [RAW]
 - When using [Time Lapse Shot]
 - When using [Stop Motion Animation] (only when [Auto Shooting] is set)

[Multi Exp.]

Applicable modes:   **P A S M**

Gives an effect like multi exposure. (up to 4 times equivalent per a single image)

MENU →  **[Rec]** → **[Multi Exp.]**

1 Press ▲/▼ to select [Start] and then press [MENU/SET].

2 Decide on the composition, and take the first picture.

- After taking the picture, press the shutter button halfway down to take the next picture.
- Press ▲/▼ to select the item and then press [MENU/SET] for one of the following operations.
 - [Next]: Advance to the next picture.
 - [Retake]: Return to the first picture.
 - [Exit]: Record the image of the first picture, and finish the multiple exposure picture-taking session.

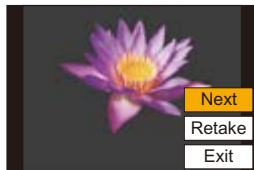

3 Shooting the second, third, and fourth exposures.

- To save the recorded pictures and finish Multiple Exposure, press [Fn3] when taking pictures.

4 Press ▲/▼ to select [Exit] and then press [MENU/SET].

- You can also press the shutter button halfway to finish.

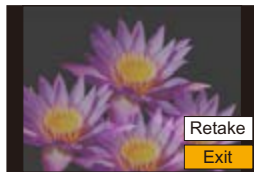

■ Changing settings

[Auto Gain]	If you select [OFF], all exposure results are superimposed as they are. Compensate the exposure as necessary, depending on the subject.
[Overlay]	If you select [ON], you can apply Multi Exposure to previously recorded images. After [Start] is selected, images on the card will be displayed. Select a RAW image, and press [MENU/SET] to proceed to recording.

- You cannot operate the zoom when taking the second and subsequent pictures.
- The recording information displayed for pictures taken with multiple exposures is the recording information for the last picture taken.
- You can perform [Overlay] only for RAW images recorded with the camera.

Not available in these cases:

- This function is not available in the following cases:
 - When using [Filter Settings]
 - When using [Panorama Shot]
 - When using [Time Lapse Shot]
 - When using [Stop Motion Animation]

 : [Motion Picture] menu

- [Rec Format] (P158)
- [Rec Quality] (P158)
- [AFS/AFF/AFC] (P75)
- [Continuous AF] (P160)
- [Photo Style] (P174)
- [Filter Settings] (P123)
- [Metering Mode] (P176)
- [Highlight Shadow] (P177)
- [i.Dynamic] (P178)
- [i.Resolution] (P178)
- [ISO Auto Upper Limit (Video)] (P184)
- [Diffraction Compensation] (P180)
- [Stabilizer] (P140)
- [i.Zoom] (P143)
- [Digital Zoom] (P144)
- [Picture Mode in Rec.] (P161)
- [Sound Rec Level Disp.] (P162)
- [Sound Rec Level Adj.] (P162)
- [Wind Noise Canceller] (P184)

[ISO Auto Upper Limit (Video)]

Applicable modes:   **P A S M**

You can set the upper limit of ISO sensitivity when ISO sensitivity is set to [AUTO] or [iISO].

MENU →  [Motion Picture] → [ISO Auto Upper Limit (Video)]

Settings: [AUTO]/[400]/[800]/[1600]/[3200]/[6400]

[Wind Noise Canceller]

Applicable modes:   **P A S M**

This will reduce the wind noise coming into the built-in microphone while maintaining sound quality.

MENU →  [Motion Picture] → [Wind Noise Canceller]

Settings: [HIGH]/[STANDARD]/[OFF]

- [HIGH] effectively reduces the wind noise by minimising the low-pitched sound when a strong wind is detected.
- [STANDARD] extracts and reduces only the wind noise without deteriorating the sound quality.
- You may not see the full effect depending on the recording conditions.

 **[Custom] menu**
 **[Exposure]**

- [ISO Increments] (P186)
- [Extended ISO] (P186)
- [Exposure Comp. Reset] (P186)

 **[Focus / Release Shutter]**

- [AF/AE Lock] (P90)
- [AF/AE Lock Hold] (P186)
- [Shutter AF] (P186)
- [Half Press Release] (P186)
- [Quick AF] (P186)
- [Eye Sensor AF] (P187)
- [Pinpoint AF Setting] (P187)
- [AF Assist Lamp] (P187)
- [Direct Focus Area] (P187)
- [Focus/Release Priority] (P188)
- [Focus Switching for Vert / Hor] (P188)
- [Loop Movement Focus Frame] (P188)
- [AF Area Display] (P188)
- [AF+MF] (P189)
- [MF Assist] (P189)
- [MF Assist Display] (P189)

 **[Operation]**

- [Fn Button Set] (P50)
- [Q.MENU] (P190)
- [iA Button Switch] (P190)
- [Control Ring] (P55)
- [Operation Lock Setting] (P190)
- [Video Button] (P190)
- [Touch Settings] (P190)
- [Dial Guide] (P191)
- [Zoom lever] (P191)

 **[Monitor / Display]**

- [Auto Review] (P191)
- [Monochrome Live View] (P192)
- [Constant Preview] (P192)
- [Live View Boost] (P192)
- [Peaking] (P193)
- [Histogram] (P193)
- [Guide Line] (P194)
- [Center Marker] (P194)
- [Highlight] (P194)
- [Zebra Pattern] (P195)
- [Expo.Meter] (P195)
- [MF Guide] (P195)
- [LVF/Monitor Disp. Set] (P41)
- [Monitor Info. Disp.] (P196)
- [Rec Area] (P196)
- [Remaining Disp.] (P196)

 **[Lens / Others]**

- [Lens Position Resume] (P196)
- [Lens Retraction] (P196)
- [Self Timer Auto Off] (P196)
- [Face Recog.] (P197)
- [Profile Setup] (P199)

MENU →  **[Custom]** →  **[Exposure]**

[ISO Increments]

This changes the increments used to set the ISO sensitivity.

Settings: [1/3 EV]/[1 EV]

[Extended ISO]

ISO sensitivity can be set up to minimum [ISO100].

[Exposure Comp. Reset]

This resets the exposure compensation value set with the function button when you change the Recording Mode or turn off the camera.

MENU →  **[Custom]** →  **[Focus / Release Shutter]**

[AF/AE Lock Hold]

When [ON] is selected, focus and exposure stays locked even if you press and release [AF/AE LOCK].

To clear the lock, press [AF/AE LOCK] again.

[Shutter AF]

Set whether or not the focus is adjusted automatically when the shutter button is pressed halfway.

[Half Press Release]

The shutter will immediately fire when the shutter button is pressed halfway.

[Quick AF]

The camera automatically adjusts the focus when the amount of camera blur becomes small.

This will speed up the focusing that takes place when you press the shutter button.

- The battery will be consumed faster than usual.



Not available in these cases:

- This function is not available in the following cases:
 - In Preview Mode
 - In low light situations

[Eye Sensor AF]

The camera automatically adjusts the focus when the eye sensor is active.

- [Eye Sensor AF] may not work in dimly lit conditions.

[Pinpoint AF Setting]

This changes the setting for an enlarged display that appears when the Auto Focus Mode is set to [+].

[Pinpoint AF Time]	Sets the time for which the enlarged screen is displayed when the shutter button is pressed halfway.
[Pinpoint AF Display]	Sets the display mode of the enlarged screen (windowed screen/full screen).

[AF Assist Lamp]

This lights the AF Assist Lamp for easier focusing when you press the shutter button halfway while recording in a dark location.

- The effective range of the AF assist lamp is 1.5 m (4.9 feet).
- [AF Assist Lamp] is fixed to [OFF] in the following case:
 - When [Silent Mode] is set to [ON]

[Direct Focus Area]

This moves the AF area or MF Assist using the cursor button when recording.

- You can move the positions below with the cursor button.
 - When [👤]/[📏]/[🔍]/[📐] is selected: AF area
 - When [🔒] is selected: lock-on position
 - When [+] is selected: enlarged area
- Use the Quick Menu (P49) or function buttons (P50) to set the functions assigned to the cursor button, such as White Balance and ISO sensitivity.
- [Direct Focus Area] is fixed to [OFF] in the following case:
 - When using [Filter Settings]

[Focus/Release Priority]

Set whether to give priority to focus or shutter release during Auto Focus.

- Different settings can be applied to different Focus Mode settings ([AFS/AFF], [AFC]).

[FOCUS]	Disables recording when focus is not achieved.
[BALANCE]	Performs recording while controlling the balance between focusing and shutter release timing.
[RELEASE]	Enables recording even when focus is not achieved.

[Focus Switching for Vert / Hor]

Focus positions are stored separately for the camera's horizontal and vertical orientations.

[ON]	<p>Memorises separate positions for horizontal and vertical orientations (two vertical orientations, left and right, are available).</p> <ul style="list-style-type: none"> • The following last-specified positions will be memorised. <ul style="list-style-type: none"> – The last AF area position (when [F], [■] or [⊕] is used) – The last MF Assist display position 	
[OFF]	Sets the same setting for both horizontal and vertical orientations.	

[Loop Movement Focus Frame]

When setting the AF area position or the MF Assist display position, you can now loop the position from one edge to the other edge of the screen.

[AF Area Display]

This changes the AF area display setting for when the Auto Focus Mode is set to [AFS/AFF] ([49-Area]) or [AFC], etc. ([Custom Multi]).

[ON]	<p>Displays AF areas on the recording screen.</p> <ul style="list-style-type: none"> • AF areas are not displayed when the default AF area setting is applied to [AFS/AFF] ([49-Area]) or [C1], [C2] or [C3] in [Custom Multi].
[OFF]	Displays AF areas on the recording screen for just a few seconds after you start using them.

- Even when [ON] is set, the same operation as [OFF] is performed in the following cases:
 - When recording motion pictures
 - When recording 4K photos





[AF+MF]

You can fine-adjust the focus manually during AF lock (when the following conditions are met).

- When [AFS/AFF/AFC] in the [Rec] menu is set to [AFS] and the shutter button is pressed halfway.
- When [AF/AE LOCK] is pressed

[MF Assist]

Sets the display method of MF Assist (enlarged screen).

	Enlarges the display when you rotate the control ring or press  (◀).
	Enlarges the display when you rotate the control ring.
	Enlarges the display when you press  (◀).
[OFF]	The screen is not be enlarged.

- MF Assist is not displayed in the following cases:
 - When recording motion pictures
 - When recording with [4K Pre-Burst]
 - When using the Digital Zoom

[MF Assist Display]

Sets whether MF Assist (enlarged screen) will appear in a windowed screen display or in a full screen display.

MENU →  **[Custom]** →  **[Operation]**

[Q.MENU]

If you select [CUSTOM], you can customise the Quick Menu settings. (P49)

[iA Button Switch]

This changes the operation method of the [iA] button.

[Single Press]	Switches the camera between Intelligent Auto Mode and Recording Mode (P/A/S/M) when you press [iA].
[Press and hold]	Switches the camera between Intelligent Auto Mode and Recording Mode (P/A/S/M) when you press and hold [iA] for a short while.

[Operation Lock Setting]

This sets which control functions will be disabled when [Operation Lock] is set in [Fn Button Set] (P50) of the [Custom] ([Operation]) menu.

[Cursor]	Disables the functions of the cursor button and the [MENU/SET] button.
[Touch Screen]	Disables the touch functions of the touch panel.
[Dial]	Disables the functions of the control dial and control ring.

[Video Button]

Enables/disables the motion picture button.

[Touch Settings]

Enables/disables the Touch operation.



[Touch Screen]	All touch operations.
[Touch Tab]	Operations of tabs, such as [
[Touch AF]	Operation to bring the subject you touch into focus ([AF]) or adjust the focus and brightness ([AF+AE]). (P86)
[Touch Pad AF]	Operation to move the AF area by touching the monitor when the viewfinder is in use. (P85)

[Dial Guide]



Enabling/disabling the operation guide display when switching recording modes.

**[Zoom lever]**

Sets the zooming performed with the zoom lever.

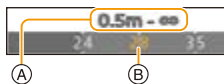
 (Zoom)	Performs normal zooming.
 (Step Zoom)	<p>Stops the zoom at the position for one of the preset focal lengths each time you operate the zoom.</p> <ul style="list-style-type: none"> This does not work for motion picture recording or [4K Pre-Burst] recording. <p> (A) Focus range (B) Current zoom position </p>



MENU →  **[Custom]** →  **[Monitor / Display]**

[Auto Review]

Displays a picture immediately after it is taken.

[Duration Time (photo)]	Sets the display time of the images recorded after picture-taking.
[Duration Time (4K PHOTO)]	Sets whether to display/hide the images recorded after 4K photo recording.
[Duration Time (Post Focus)]	Sets whether to display/hide the recorded images after recording with the Post Focus function.
[Playback Operation Priority]	Allows you to change or delete the playback image during Auto Review.

- When [Duration Time (photo)] is set to [HOLD], the images are displayed until the shutter button is pressed halfway. [Playback Operation Priority] will be fixed to [ON].
- When [Grain Effect] is selected for [Photo Style], [Auto Review] is not displayed during [Time Lapse Shot] and [Stop Motion Animation] recording.

[Monochrome Live View]

You can display the recording screen in black and white.

This is convenient for focusing with Manual Focus.

- Recorded images will not be affected.

[Constant Preview]

You can check the effects of the chosen aperture and shutter speed on the recording screen in Manual Exposure Mode.

- This function does not work when using the flash.

[Live View Boost]

The screen is displayed brighter to make it easier to check the composition in low-light environment.

The screen is displayed brighter than the image to be recorded, so noise may become noticeable.

- With [SET] you can change the Recording Mode that uses [Live View Boost] to display the screen.
- Noise may be more noticeable in the screen than in the recorded image.
- [Live View Boost] does not work in the following cases:
 - When adjusting the exposure (when the shutter button is pressed halfway, for example)
 - When recording a motion picture or 4K photo
 - When using [Filter Settings]
 - When using [Constant Preview]

[Peaking]

In-focus portions (portions on the screen with clear outlines) are highlighted when focus is being adjusted manually.

- When [Detect Level] in [SET] is set to [HIGH], portions to be highlighted are reduced, allowing you to achieve a more precise focus.
- Changing the [Detect Level] setting also changes the [Display Color] setting as follows.

[Detect Level]	[HIGH]	↔	[LOW]
[Display Color]	[] (Light blue)		[] (Blue)
	[] (Yellow)		[] (Orange)
	[] (Yellow-green)		[] (Green)
	[] (Pink)		[] (Red)
	[] (White)		[] (Grey)

- Each time [] in [] is touched, the setting is switched in order of [PEAK L] ([Detect Level]: [LOW]) → [PEAK H] ([Detect Level]: [HIGH]) → [OFF].
- [Peaking] is not available when using [Live View Boost]
- [Peaking] does not work with [Rough Monochrome] in [Filter Settings].

[Histogram]

Display the histogram.

You can set the position by pressing ▲/▼/◀/▶.

- Direct touch operation is also possible from the recording screen.
- A histogram is a graph that displays brightness along the horizontal axis (black to white) and the number of pixels at each brightness level on the vertical axis. It allows you to easily check a picture's exposure.

- Ⓐ dark
- Ⓑ bright

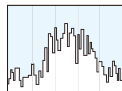

- **When the recorded picture and the histogram do not match each other under the following conditions, the histogram is displayed in orange.**
 - During Exposure Compensation
 - When the flash is activated
 - When the correct exposure is not achieved, such as when the lighting is low.
- The histogram is an approximation in the Recording Mode.

[Guide Line]

This will set the pattern of guide lines displayed when taking a picture.

When [] is set, guideline positions can be set by pressing ▲/▼/◀/▶.

- You can also set the position directly by touching [] on the guideline of the recording screen.
- Guide lines are not displayed during panorama recording.

[Center Marker]

The centre of the recording screen will be displayed as [+].

[Highlight]

When the Auto Review function is activated or when playing back, white saturated areas appear blinking in black and white.



- If there are any white saturated areas, we recommend compensating the exposure towards negative referring to the histogram and then taking the picture again. It may result in a better quality picture.
- The highlight display does not work in the following cases:
 - During 4K photo playback
 - During playback of images recorded with the Post Focus function
 - During Multi Playback
 - During Calendar Playback
 - During Playback Zoom

[Zebra Pattern]

Indicates parts that may become white saturated through overexposure in a zebra pattern.



Select [SET] to set the brightness to be processed as a zebra pattern.

- You can select a brightness value between [50%] and [105%]. In [Zebra 2], you can select [OFF]. If you select [100%] or [105%], only the areas that are already white saturated are displayed in a zebra pattern. The smaller the value is, the wider the brightness range to be processed as a zebra pattern will be.
- If there are any white saturated areas, we recommend compensating the exposure towards negative referring to the histogram and then taking the picture.
- Displayed zebra patterns will not be recorded.
- If you assign [Zebra Pattern] to [Fn Button Set] in the [Custom] ([Operation]) menu, each time you press the function button to which the setting is assigned, the zebra pattern toggles as follows:
[Zebra 1] → [Zebra 2] → [OFF].
If you set [Zebra 2] to [OFF], the pattern toggles in the order of [Zebra 1] → [OFF]

[Expo.Meter]

Display the exposure metre.

- Set to [ON] to display the Exposure metre when performing Programme Shift, setting aperture, and setting shutter speed.
- Unsuitable areas of the range are displayed in red.
- When the Exposure metre is not displayed, switch the display information for screen by pressing [DISP.].
- If no operations are performed for approximately 4 seconds, the Exposure metre disappears.

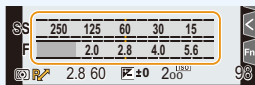
**[MF Guide]**

When you set the focus manually, an MF guide that allows you to check the direction to achieve focus is displayed.

- Ⓐ Indicator for ∞ (infinity)





[Monitor Info. Disp.]

Display the recording information screen. (P41, 287)

[Rec Area]

This changes the angle of view during motion picture recording and still picture recording.

	Displays the recording area according to the angle of view for still picture recording.
	Displays the recording area according to the angle of view for motion picture recording.



- The recording area indicated is an approximation.

 **Not available in these cases:**

- When recording with the 4K Photo function or Post Focus function, [Rec Area] is fixed to .

[Remaining Disp.]

This will switch display between the number of recordable pictures and available recording time.

MENU →  **[Custom]** →  **[Lens / Others]**

[Lens Position Resume]

This memorises the zoom and focus positions when you turn off the camera.

[Lens Retraction]



This retracts the lens barrel a little while after you switch to the playback screen.

[Self Timer Auto Off]

This sets the self-timer so that it will be cancelled when the camera is turned off.

[Face Recog.]

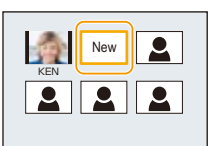
Face Recognition is a function which finds a face resembling a registered face and priorities focus and exposure automatically. Even if the person is located towards the back or on the end of a line in a group photo, the camera can still take a clear picture.

[ON]	Enables the Face Recognition function.						
[OFF]	Disables the Face Recognition function.						
[MEMORY]	Allows you to register face images, or edit or delete registered information.						
	Face Settings						
	You can register information such as names and birthdays for face images of up to 6 people.						
	<ol style="list-style-type: none"> Press ▲/▼/◀/▶ to select the Face Recognition frame that is not registered, and then press [MENU/SET]. 						
	<ol style="list-style-type: none"> Take the picture adjusting the face with the guide. <ul style="list-style-type: none"> The faces of subjects other than people (pets, etc.) cannot be registered. To display the description of the face registration, press ► or touch [i]. 						
	<ol style="list-style-type: none"> Set the item. <ul style="list-style-type: none"> You can register up to 3 face images. 						
	<table border="1"> <tr> <td data-bbox="260 714 379 773">[Name]</td> <td colspan="2" data-bbox="379 714 1013 773">It is possible to register names. • For information on how to enter characters, refer to P56.</td> </tr> </table>	[Name]	It is possible to register names. • For information on how to enter characters, refer to P56.				
	[Name]	It is possible to register names. • For information on how to enter characters, refer to P56.					
	<table border="1"> <tr> <td data-bbox="260 773 379 816">[Age]</td> <td colspan="2" data-bbox="379 773 1013 816">It is possible to register the birthday.</td> </tr> </table>	[Age]	It is possible to register the birthday.				
	[Age]	It is possible to register the birthday.					
<table border="1"> <tr> <td data-bbox="260 816 379 904" rowspan="2">[Add Images]</td> <td data-bbox="379 816 498 904">(Add Images)</td> <td data-bbox="498 816 1013 904">To add additional face images. • Select a blank face image frame to register a new image.</td> </tr> <tr> <td data-bbox="379 904 498 962">(Delete)</td> <td data-bbox="498 904 1013 962">To delete one of the face images. • Select the face image you want to delete.</td> </tr> </table>	[Add Images]	(Add Images)	To add additional face images. • Select a blank face image frame to register a new image.	(Delete)	To delete one of the face images. • Select the face image you want to delete.		
[Add Images]		(Add Images)	To add additional face images. • Select a blank face image frame to register a new image.				
	(Delete)	To delete one of the face images. • Select the face image you want to delete.					
Change or delete the information for a registered person							
<ol style="list-style-type: none"> Press ▲/▼/◀/▶ to select the face image to edit or delete and then press [MENU/SET]. 							
<ol style="list-style-type: none"> Set the item. 							
<table border="1"> <tr> <td data-bbox="260 1093 379 1151">[Info Edit]</td> <td colspan="2" data-bbox="379 1093 1013 1151">Changing the information of an already registered person. • Perform step ③ in "Face Settings".</td> </tr> </table>	[Info Edit]	Changing the information of an already registered person. • Perform step ③ in "Face Settings".					
[Info Edit]	Changing the information of an already registered person. • Perform step ③ in "Face Settings".						
<table border="1"> <tr> <td data-bbox="260 1151 379 1239">[Priority]</td> <td colspan="2" data-bbox="379 1151 1013 1239">The focus and exposure are preferentially adjusted for higher-priority faces. • Rearrange and set the face priority.</td> </tr> </table>	[Priority]	The focus and exposure are preferentially adjusted for higher-priority faces. • Rearrange and set the face priority.					
[Priority]	The focus and exposure are preferentially adjusted for higher-priority faces. • Rearrange and set the face priority.						
<table border="1"> <tr> <td data-bbox="260 1239 379 1274">[Delete]</td> <td colspan="2" data-bbox="379 1239 1013 1274">Deleting information of a registered person.</td> </tr> </table>	[Delete]	Deleting information of a registered person.					
[Delete]	Deleting information of a registered person.						

Point of recording when registering the face images

- Face front with eyes open and mouth closed, making sure the outline of the face, the eyes, or the eyebrows are not covered with hair when registering.
- Make sure there is no extreme shading on the face when registering.
(Flash will not flash during registration.)

(Good example for registering)

**When face is not recognised during recording**

- Register the face of same person indoors and outdoors, or with different expressions or angles.
- Additionally register at the location of recording.
- When a person who is registered is not recognised, correct by re-registering.
- Face Recognition may not be possible or may not recognise faces correctly even for registered faces, depending on the facial expression and environment.

• The following functions will also work with the Face Recognition function.**In Recording Mode**

- Display of corresponding name when camera detects a registered face*

In Playback Mode

- Display of name and age
- * Names of up to 3 people are displayed.

Precedence for the names displayed when taking pictures is determined according to the order of registration.

• [Face Recog.] only works when the AF Mode is set to [AF].

- It works only when a face has been detected.
- When you specify the person to be brought into focus, [Face Recog.] is not work.
- During the Burst Mode, [Face Recog.] picture information can be attached to only the first picture.
- When group pictures are played back, the name of the first picture of the set is displayed.

**Not available in these cases:**

- [Face Recog.] does not work in the following cases.
 - When using [Miniature Effect] in [Filter Settings]
 - When recording motion pictures
- [Face Recog.] cannot be set in the following cases:
 - When recording 4K photos
 - When recording with the Post Focus function
 - When using [Panorama Shot]
 - When using [Time Lapse Shot]

[Profile Setup]

If you set the name and birthday of your baby or pet in advance, you can record their name and age in months and years in the images.

You can display these at playback or stamp the recorded images using [Text Stamp].

Settings: [**⊗**¹] ([Baby1])/[**⊗**²] ([Baby2])/[**⊗**] ([Pet])/[OFF]/[SET]

■ Setting [Age] or [Name]

- 1 Press ▲/▼ to select [SET] and then press [MENU/SET].
- 2 Press ▲/▼ to select [Baby1], [Baby2] or [Pet] and then press [MENU/SET].
- 3 Press ▲/▼ to select [Age] or [Name] and then press [MENU/SET].
- 4 Press ▲/▼ to select [SET] and then press [MENU/SET].

Enter [Age] (birthday).

Enter [Name].

• For information on how to enter characters, refer to P56.

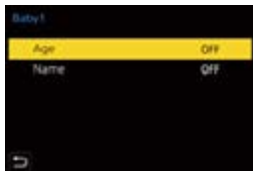

■ To cancel the display of [Age] and [Name]

Select [OFF] in [Profile Setup].

• You can print out ages and names with “PHOTOfunSTUDIO”.



Not available in these cases:

- [Profile Setup] is not available when recording is performed with the 4K Photo or Post Focus function.
- Ages and names are not recorded in the following cases:
 - When recording motion pictures
 - Still pictures recorded during motion picture recording

: [Setup] menu

- [Online Manual] (P200)
- [Utilize Custom Set feature] (P71)
- [Cust.Set Mem.] (P71)
- [Clock Set] (P32)
- [World Time] (P200)
- [Travel Date] (P201)
- [Wi-Fi] (P201)
- [Bluetooth] (P202)
- [Wireless Connection Lamp] (P202)
- [Beep] (P202)
- [Economy] (P203)
- [Monitor Display Speed] (P203)
- [LVF Display Speed] (P203)
- [Monitor Display]/[Viewfinder] (P204)
- [Monitor Luminance] (P204)
- [Eye Sensor] (P205)
- [USB Mode] (P205)
- [TV Connection] (P206)
- [Language] (P206)
- [Version Disp.] (P206)
- [Folder / File Settings] (P207)
- [No.Reset] (P208)
- [Reset] (P208)
- [Reset Network Settings] (P209)
- [Level Gauge Adjust.] (P209)
- [Demo Mode] (P209)
- [Format] (P28)

MENU →  [Setup]

[Online Manual]

Settings: [URL display]/[QR Code display]

[World Time]

Sets the times for the region where you live and your holiday destination.

- [Destination] can be set after setting up [Home].

After selecting [Destination] or [Home], press ◀▶ to select an area, and press [MENU/SET] to set.

[Destination]:

Travel destination area

- (A) Current time of the destination area
- (B) Time difference from home area

[Home]:

Your home area

- (C) Current time
- (D) Time difference from GMT (Greenwich Mean Time)

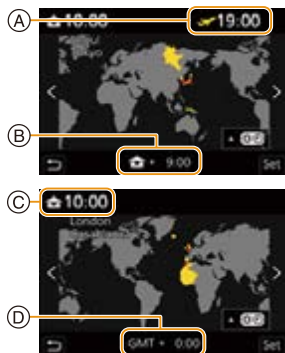

- If you are using Daylight Savings [, press ▲. (The time will move forward by 1 hour.) To return to the normal time, press ▲ again.
- Set to [Home] when you have returned from your travel destination.
- If you cannot find the travel destination in the areas displayed on the screen, set by the time difference from the home area.

[Travel Date]

[Travel Setup]	If you set your travel schedule and record images, elapsed days (how many days after) of the travel will be recorded.
[Location]	When [Travel Setup] is set, you can set your travel destination. • For information on how to enter characters, refer to P56 .

- You can display the elapsed days and travel destination during playback or stamp them on recorded pictures in [Text Stamp].
- The elapsed days and travel destination can be printed out using the software “PHOTOfunSTUDIO”.
- The travel date is calculated using the date in the clock setting and the departure date you set. If you set [World Time] to the travel destination, the travel date is calculated using the date in the clock setting and the travel destination setting.
- When [Travel Setup] is set to [OFF], the number of days elapsed is not recorded. It is not displayed even if [Travel Setup] is set to [SET] after recording.
- When the current date passes the return date, [Travel Setup] is automatically cancelled.
- [Travel Date] cannot be recorded for AVCHD motion pictures.
- [Location] cannot be recorded in the following cases:
 - When recording motion pictures
 - When recording 4K photos
 - When recording with the Post Focus function

[Wi-Fi]

- [\[Wi-Fi Function\] \(P227\)](#)
- [\[Wi-Fi Setup\] \(P269\)](#)

[Bluetooth]

- **[Bluetooth]** (P231)
- **[Remote Wakeup]** (P237)
- **[Returning from Sleep Mode]** (P241)
- **[Auto Transfer]** (P243)
- **[Location Logging]** (P245)
- **[Auto Clock Set]** (P246)
- **[Wi-Fi network settings]**

Registers a wireless access point. (P263)

- The wireless access point used for the Wi-Fi connection is automatically registered.
- Up to 17 wireless access points can be registered. If you try to register more than 17 access points, the oldest registered access points will be deleted.
- Performing [Reset Network Settings] will delete registered wireless access points.

[Wireless Connection Lamp]

This enables/disables the WIRELESS connection lamp.
If you select [OFF], they will not light/flash.

[Beep]

This allows you to set the electronic sound and the electronic shutter sound.

Settings: [Beep Volume]/[Shutter Vol.]/[Shutter Tone]

- [Beep] is not available when [Silent Mode] is set to [ON].

[Economy]

[Sleep Mode]	The camera is automatically turned off if the camera has not been used for the time selected on the setting.
[Sleep Mode(Wi-Fi)]	The camera is automatically turned off if it is not connected to a Wi-Fi network and has not been used for 15 minutes (approx.).
[Auto LVF/ Monitor Off]	The monitor/viewfinder is automatically turned off if the camera has not been used for the time selected on the setting.

- To cancel [Sleep Mode] or [Sleep Mode(Wi-Fi)], perform either of the following operations:
 - Press the shutter button halfway.
 - Turn off and on the camera.
- To turn the monitor/viewfinder on again, press any button.
- [Economy] does not work in the following cases.
 - When connecting to a PC or a printer
 - When recording or playing back motion pictures
 - During a slide show
 - When recording with [4K Pre-Burst]
 - When recording in [Multi Exp.]
 - When using [Time Lapse Shot]
 - When using [Stop Motion Animation] (only when [Auto Shooting] is set)
- When using the AC adaptor (optional) and DC coupler (optional), [Sleep Mode] or [Sleep Mode(Wi-Fi)] is disabled.

[Monitor Display Speed]/[LVF Display Speed]

This sets the monitor/viewfinder frame rate.

[ECO30fps]	Reduces the power consumption, extending the operating time.
[60fps]	Displays movements smoother. This setting is ideal for recording fast-moving subjects.

- When [Monitor Display Speed] or [LVF Display Speed] (or both) is set to [ECO30fps], Digital Zoom is not available.
- The [Monitor Display Speed]/[LVF Display Speed] setting does not affect the recorded picture.
- Images are displayed at [60fps] in the following cases:
 - When recording 4K photos
 - When recording with the Post Focus function

[Monitor Display]/[Viewfinder]

Brightness, colour, or red or blue tint of the monitor/viewfinder is adjusted.

- 1 Select the settings by pressing ▲/▼, and adjust with ◀/▶.
- 2 Press [MENU/SET] to set.

- It will adjust the monitor when the monitor is in use, and the viewfinder when the viewfinder is in use.
- Some subjects may appear differently from actuality on the monitor. However, this does not affect the recorded pictures.

[Monitor Luminance]

[A*] (Auto)	The brightness is adjusted automatically depending on how bright it is around the camera.
[1*] (Mode 1)	Make the monitor brighter.
[2*] (Mode 2)	Set the monitor to the standard brightness.
[3*] (Mode 3)	Make the monitor darker.



- Some subjects may appear differently from actuality on the monitor. However, this does not affect the recorded pictures.
- The monitor automatically returns to standard brightness if no operations are performed for 30 seconds when recording in [1*]. It will light up brightly again with button or touch operation.
- When [A*] or [1*] is set, the usage time is reduced.
- [A*] is only available in the Recording Mode.
- When the AC adaptor (optional) and DC coupler (optional) are used, the initial setting is [2*].

[Eye Sensor]

[Sensitivity]	This will set the sensitivity of the eye sensor.
[LVF/Monitor Switch]	This will set the method for switching between the monitor and viewfinder. [LVF/MON AUTO] (automatic switching between the monitor and viewfinder) [LVF] (viewfinder) [MON] (monitor) <ul style="list-style-type: none"> • If you press [LVF] to switch the display, the [LVF/Monitor Switch] setting will also switch.

[USB Mode]

Sets the communication method when connecting using the USB connection cable (supplied).

 [Select on connection]	Select this setting to select the USB communication system when connecting to another device.
 [PC(Storage)]	Select this setting to export images to a connected PC.
 [PictBridge(PTP)]	Select this setting when connecting to a printer supporting PictBridge.

[TV Connection]**[HDMI Mode (Play)]:**

This sets the video format to be used for output in Playback Mode when the camera and a TV or monitor is connected with an HDMI micro cable.

[AUTO]	Outputs images at an output resolution suited to the connected TV.
[4K/25p]/[1080p]/[1080i]/[720p]/[576p]	Outputs images at the selected resolution. <ul style="list-style-type: none"> • The output resolution for [4K/25p] is 3840×2160. • Even when [4K/25p] is set, MP4 motion pictures recorded with [4K/100M/30p] will be output at a resolution of [4K/30p]. • Even when [576p] is set, depending on the connected TV, images will be output at a resolution of [480p].

- If no image appears on your TV when [AUTO] is set, switch to a setting other than [AUTO] that can display images on the TV.

[VIERA Link]:

If you select [ON], operations of the camera and the VIERA Link compatible equipment connected to the camera with an HDMI micro cable are automatically linked, enabling you to control the camera with the remote control of the VIERA Link compatible equipment.

[Language]

Set the language displayed on the screen.

- If you set a different language by mistake, select [00] from the menu icons to set the desired language.

[Version Disp.]

This enables the firmware versions of the camera to be checked.

- To display information about the software on the unit, press [MENU/SET] on the version display screen.

[Folder / File Settings]

Set the folder and file name patterns in which images are to be saved.

Folder name		File name	
100ABCDE 		PABC0001.JPG 	
1	Folder number (3-digits, 100–999)	1	Colour space ([P]: sRGB, [_]: AdobeRGB)
2	5-digit user-defined segment	2	3-digit user-defined segment
		3	File number (4-digits, 0001–9999)
		4	File extension

[Select Folder]	Specifies the folder to which images are to be saved. • The folder name is indicated with the number of files that can be stored.	
[Create a New Folder]	[OK]	Creates a new folder with the same 5-digit user-defined segment as the current folder name setting.
	[Change]	Allows you to redefine the 5-digit user-defined segment before creating a new folder. • Available characters: alphabet (upper case characters), numbers, and [_] • For information on how to enter characters, refer to P56 .
	• A new folder with an incremented folder number is created. • If there are no recordable folders in the card, a screen for resetting the folder number is displayed.	
[File Name Setting]	[Folder Number Link]	Uses the folder number of the folder name as the file name's 3-digit user-defined segment.
	[User Setting]	Allows you to define and set the 3-digit user-defined segment of the file name. • Available characters: alphabet (upper case characters), numbers, and [_] • For information on how to enter characters, refer to P56 .

- Each folder can store up to 1000 files.
- File numbers are assigned sequentially from 0001 to 9999 in the order of recording. If you change the storage folder, a continuing number from the last file number will be assigned.
- In the following cases, a new folder with an incremented folder number will be created automatically when the next file is saved:
 - The current folder contains 1000 files
 - The current folder contains a file with the file number “9999”
- New folders cannot be created when there are folders numbered from 100 all the way up to 999. In this case, we recommend saving their data to a computer or similar device and formatting the card.

[No.Reset]

Reset the file number of the next recording to 0001.

- When recording is performed after resetting this item, the folder number is updated and the file number starts from 0001.
- A folder number between 100 and 999 can be assigned.
The folder number should be reset before it reaches 999. We recommend formatting the card after saving the data on a PC or elsewhere.
- To reset the folder number to 100:
 - 1 Perform [Format] to format the card.
 - 2 Perform [No.Reset] to reset the file number.
 - 3 Select [Yes] on the folder number reset screen.

[Reset]

The following settings are reset to the default:

- Recording settings and the drive mode.
- Setup settings ([Wi-Fi Setup] and [Bluetooth] settings)
- Custom settings ([Face Recog.] and [Profile Setup] settings)
- Setup/custom settings (except for [Wi-Fi Setup], [Bluetooth], [Face Recog.] and [Profile Setup])
- When the setup/custom settings are reset, the following settings are also reset.
 - The [World Time] setting
 - The settings of [Travel Date] (departure date, return date, location)
 - The settings of [Rotate Disp.], [Picture Sort] and [Delete Confirmation] in the [Playback] menu
- Folder numbers and clock settings are not reset.
- When requesting a repair or transferring/disposing of the camera, refer to “About the personal information” on [P305](#).

[Reset Network Settings]

The following network settings are reset to the default:

- [Wi-Fi Setup] (Excluding [LUMIX CLUB])
- Registered device information in [Bluetooth] and values in [Wi-Fi network settings]

• When requesting a repair or transferring/disposing of the camera, refer to “About the personal information” on [P305](#).

[Level Gauge Adjust.]

[Adjust.]	Hold the camera in a horizontal position, and press [MENU/SET]. The level gauge will be adjusted.
[Level Gauge Value Reset]	Restores the default level gauge setting.

[Demo Mode]

You can try Post Focus operations, such as focusing and Peaking, with the image picture.

👤 : [My Menu] menu**[My Menu Setting]**

Register frequently-used menus and display them in [My Menu]. You can register up to 23 menus.

[MENU] → 👤 **[My Menu]** → **[My Menu Setting]**

[Add]	Specifies the menu to be displayed in My Menu to register it.
[Sorting]	Rearranges the menus displayed in My Menu. Select the menu you want to move and set the destination.
[Delete]	Deletes registered menus. [Delete Item]: Deletes selected menus. [Delete All]: Deletes all of the menus.
[Display from My Menu]	Sets the first menu to be displayed when the menu screen is displayed. [ON]: Displays My Menu. [OFF]: Displays the last-used menu.

: **[Playback] menu**

- [Slide Show] (P211)
- [Playback Mode] (P212)
- [Protect] (P213)
- [Rating] (P213)
- [Title Edit] (P214)
- [Face Rec Edit] (P214)
- [RAW Processing] (P215)
- [4K PHOTO Bulk Saving] (P217)
- [Light Composition] (P218)
- [Sequence Composition] (P219)
- [Clear Retouch] (P220)
- [Text Stamp] (P221)
- [Resize] (P222)
- [Cropping] (P223)
- [Rotate] (P224)
- [Video Divide] (P224)
- [Time Lapse Video] (P225)
- [Stop Motion Video] (P225)
- [Rotate Disp.] (P225)
- [Picture Sort] (P226)
- [Delete Confirmation] (P226)

• The camera may not play back images recorded on other devices correctly, and the functions of the camera may not be available for the images.

■ How to select an image(s) after selecting [Single] or [Multi]

- When [Single] and [Multi] are not available, select an image in the same way as when [Single] is selected.

[Single] setting

- 1 Press **◀/▶** to select the picture.
- 2 Press **[MENU/SET]**.
 - If [Set/Cancel] is displayed at the right bottom of the screen, the setting is cancelled when [MENU/SET] is pressed again.



[Multi] setting

When a screen similar to the one on the right is displayed:

- 1 Press **▲/▼/◀/▶** to select the picture and then press **[MENU/SET]** (repeat).
 - The setting is cancelled when [MENU/SET] is pressed again.
- 2 Press **[DISP.]** to execute.

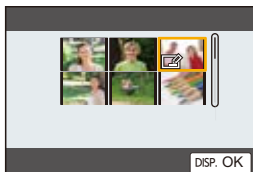

When a screen similar to the one on the right is displayed:

- Press **▲/▼/◀/▶** to select the picture, and then press **[MENU/SET]** to set (repeat).
- The setting is cancelled when [MENU/SET] is pressed again.

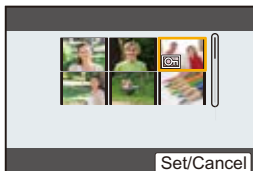

[Slide Show]

You can play back the pictures you have taken in synchronisation with music, and you can do this in sequence while leaving a fixed interval between each of the pictures.









You can also put together a slide show composed of only still pictures, only motion pictures, etc.

We recommend this feature when you view your pictures by connecting the camera to a TV.

MENU →  **[Playback]** → **[Slide Show]**

- Select the group to play back by pressing ▲/▼, and then press [MENU/SET].**
 - If you select [Picture Only], 4K burst files and images recorded with the Post Focus function will also be played back.
 - For images recorded with the Post Focus function, only an in-focus representative image will be chosen and played back.
- Press ▲/▼ to select [Start] and then press [MENU/SET].**

■ Operations during a slide show

Button operation	Touch operation	Description of operation	Button operation	Touch operation	Description of operation
▲		Play/Pause	▼		Exit slide show
◀		Back to previous picture	▶		Ahead to next picture
		Reduce volume level			Increase volume level

■ Changing the slide show settings

You can change the settings for slide show playback by selecting [Effect] or [Setup] on the slide show menu screen.

[Effect]	This allows you to select the screen effects when switching from one picture to the next.	
[Setup]	[Duration]	• [Duration] can be set only when [OFF] has been selected as the [Effect] setting.
	[Repeat]	[ON]/[OFF]
	[Sound]	[AUTO]: Music is played when the still pictures are played back, and audio is played when the motion pictures are played back. [Music]: Music is played back. [Audio]: Audio (only for motion pictures) is played back. [OFF]: There will be no sound.

- The [Effect] setting does not work while the following images are played back in a slide show:
 - 4K burst files
 - Images recorded with the Post Focus function
 - Group Pictures
- The [Duration] setting does not work while the following images are played back in a slide show:
 - Motion pictures
 - 4K burst files
 - Images recorded with the Post Focus function
 - Panorama pictures
 - Group Pictures

[Playback Mode]

Playback in [Normal Play], [Picture Only] or [Video Only] can be selected.

MENU →  **[Playback]** → **[Playback Mode]**

Select the group to play back by pressing ▲/▼, and then press [MENU/SET].

- If you select [Picture Only], 4K burst files and images recorded with the Post Focus function will also be played back.

[Protect]

You can set protection for pictures you do not want to delete by mistake.

MENU →  **[Playback]** → **[Protect]**

Select the picture. (P210)

- [999+] is displayed on the screen, if the total number of protects you set for a group pictures is more than 1000 pictures.

■ Cancelling all the [Protect] settings

Press **▲/▼** to select **[Cancel]**, and then press **[MENU/SET]**.



If you set the Write-Protect switch on the card to **[LOCK]**, images will not be deleted even when protection is not set for them.

- Be aware that the **[Protect]** setting may not work on other devices.
- Even if you protect pictures on a card, they will be deleted if the card is formatted.

[Rating]

You can set five different rating levels for images to do the following:

- Delete all the pictures not set as ratings.
- Checking the rating level on the file detail display of an operating system, such as Windows 10, Windows 8.1, or Windows 8. (JPEG images only)

MENU →  **[Playback]** → **[Rating]**

1 Select the picture. (P210)**2 Press ◀/▶ to set the rating level (1–5), and press [MENU/SET] to set.**

- When **[Multi]** has been selected, repeat steps **1** and **2** for each picture.
(It is not possible to use the same setting for a multiple number of pictures.)
- The number of a group pictures will be displayed, if you set for a group pictures. [999+] is displayed, if the group pictures is more than 1000 pictures.

■ Cancelling all the [Rating] settings

Press **▲/▼** to select **[Cancel]**, and then press **[MENU/SET]**.

- **[Cancel]** cannot be selected when **[Playback Mode]** is set to **[Picture Only]** or **[Video Only]**.
- **[AVCHD]** motion pictures can only be set to "5".

[Title Edit]

You can add text (comments) to pictures. After text has been registered, it can be stamped in prints using [Text Stamp].

MENU →  **[Playback]** → **[Title Edit]**

1 Select the picture. (P210)

-  is displayed for pictures with titles already registered.

2 Enter the text. (P56)

- To delete the title, erase all the text in the text input screen.
- You can print out texts (comments) using the software “PHOTOfunSTUDIO”.
- You can set up to 100 pictures at one time with [Multi].

 **Not available in these cases:**

- This function is not available in the following cases:
 - Motion pictures
 - 4K burst files
 - Images recorded with the Post Focus function
 - Images recorded with [Quality] set to [RAW₁], [RAW₂] or [RAW]

[Face Rec Edit]

You can clear and replace all information relating to face recognition in selected images.

MENU →  **[Playback]** → **[Face Rec Edit]**





- 1 Press ▲/▼ to select [REPLACE] or [DELETE], and then press [MENU/SET].**
- 2 Press ◀/▶ to select the picture and then press [MENU/SET].**
- 3 Press ◀/▶ to select the person and then press [MENU/SET].**
- 4 (When [REPLACE] is selected)
Press ▲/▼/◀/▶ to select the person to replace and then press [MENU/SET].**

- Cleared information regarding the [Face Recog.] cannot be restored.
- The Face Recognition information of pictures in a group has to be edited at once. (You cannot edit one picture at a time.)
- Editing of group pictures can be performed only on the first picture of each set.

[RAW Processing]



You can process the pictures taken in RAW format. The processed pictures will be saved in JPEG format.

MENU →  **[Playback]** → **[RAW Processing]**

- 1 Select RAW images with  , and then press **[MENU/SET]**.
- 2 Press   to select an item.

- You can set the following items. The settings you used for the recording are selected when you start setting these items.



[White Balance]	Allows you to select a White Balance preset and adjust it. If you select an item with  , you can process the image with the setting at the time of recording.
[Brightness correction]	Allows you to correct the brightness within the range between -2 EV and $+2$ EV.
[Photo Style]	Allows you to select a photo style effect.
[i.Dynamic]	Allows you to select an [i.Dynamic] setting.
[Contrast]	Allows you to adjust the contrast.
[Highlight]	Allows you to adjust the brightness of bright portions.
[Shadow]	Allows you to adjust the brightness of dark portions.
[Saturation]/ [Color Tone]	Allows you to adjust the saturation. (When [Monochrome], [L.Monochrome] or [L.Monochrome D] is selected in [Photo Style], you can adjust the colour tone.)
[Filter Effect]	Allows you to select a filter effect. (Only when [Monochrome], [L.Monochrome] or [L.Monochrome D] is selected in [Photo Style].)
[Grain Effect]	You can set the graininess. (Only when [Monochrome], [L.Monochrome] or [L.Monochrome D] is selected for [Photo Style].)
[Noise Reduction]	Allows you to adjust the noise reduction setting.
[i.Resolution]	Allows you to select an [i.Resolution] setting.
[Sharpness]	Allows you to adjust the resolution effect.
[More Settings]	Use   to select items and press [MENU/SET] to perform the following operations. [Reinstate Adjustments]: Returns the settings to the ones you used during the recording. [Color Space]: Allows you to select a [Color Space] setting from [sRGB] or [Adobe RGB]. [Picture Size]: Allows you to select the size in which the image will be saved in JPEG format.



3 Press [MENU/SET] and set.

- Refer to "How to set each item" on P216.

4 Press [MENU/SET].

- This operation returns you to the screen in step 2. To set other items, repeat steps 2 through 4.

5 Select [Begin Processing] with ▲/▼, and then press [MENU/SET].**■ How to set each item**

Button operation	Touch operation	Description of operation
	Dragging	Selects a setting.
	[WB K Set]	Displays the screen that lets you set the colour temperature. (only when [White Balance] is set to [K])
	[Adjust.]	Displays the screen that lets you fine-adjust the White Balance. (only when [White Balance] is set)
[DISP.]	[DISP.]	Displays the comparison screen.
[MENU/SET]	[Set]	Sets the adjusted level and returns you to the item selection screen.

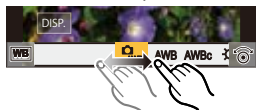

- When [Noise Reduction], [i.Resolution] or [Sharpness] is selected, the comparison screen cannot be displayed.
- Pictures can be enlarged by operating the zoom lever.
- Each time you touch the screen twice, the display switches between enlarged and normal view.

On the comparison screen, you can use the following operations to make adjustments:

Button operation	Touch operation	Description of operation
	Dragging	Selects a setting.
[DISP.]	[DISP.]	Returns you to the setting screen.
[MENU/SET]	[Set]	Sets the adjusted level and returns you to the item selection screen.

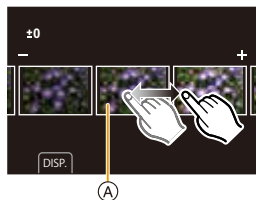

Ⓐ Current setting

- If you touch the picture at the centre, it will be enlarged. If you touch , the picture will be reduced to the original size.

- The effects applied through the RAW processing on the camera and those applied through the RAW processing on the software “SILKYPIX Developer Studio” are not completely identical.
- The [White Balance] setting of pictures taken with multiple exposures is fixed to the setting at the time of recording.
- Edit group images one by one. The edited images will be saved as new images separate from the original group images.

**Not available in these cases:**

- [RAW Processing] is not available when an HDMI micro cable is connected.
- RAW processing cannot be performed on RAW images recorded with other devices.

[4K PHOTO Bulk Saving]

You can save pictures of a 4K burst file that were extracted from any 5 second period at once.

MENU → **[Playback]** → **[4K PHOTO Bulk Saving]**

- 1 Press </> to select the 4K photo burst files and press [MENU/SET].**
 - If the burst time is 5 seconds or less, all frames will be saved as pictures.
- 2 Select the first frame of the pictures to be saved at once. (P107, 108)**
 - Pictures will be saved as a group of Burst Mode pictures in JPEG format. (P217)

[Light Composition]

Select multiple frames from 4K burst files that you wish to combine. Parts of the image that are brighter than the preceding frame will be superimposed on the preceding frame to combine the frames into one picture.



[MENU] → **[Playback]** → **[Light Composition]**

- 1 Press to select the 4K photo burst files and press **[MENU/SET]**.
- 2 Choose the combining method, and then press **[MENU/SET]**.

[Composite Merging] setting

Select the frames you want to combine to superimpose brighter parts.

- 1 Drag the slide bar or use to select the frames to combine.
- 2 Press **[MENU/SET]**.
 - The selected frames are remembered, and the display goes to the preview screen.
 - Press to select items and press **[MENU/SET]** to perform the following operations.



– **[Next]:**

Lets you select more frames for combining.

– **[Reselect]:**

Discards the frame selected immediately before and lets you select a different image.

- 3 Repeat steps 1 and 2 to select more frames to combine.
 - You can select up to 40 frames.
- 4 Press to select **[Save]**, and then press **[MENU/SET]**.

[Range Merging] setting

Select the first and last frames to superimpose the brighter parts of the frames between them.

- 1 Select the frame of the first picture, and press **[MENU/SET]**.
 - The selection method is the same as in step 1 of **[Composite Merging]** setting.
 - 2 Select the frame of the last picture, and press **[MENU/SET]**.
- 3 **Select [Yes] at the confirmation screen, and then press [MENU/SET].**
- Pictures are saved in JPEG format. Recording information (Exif information) of the first frame such as shutter speed, aperture, and ISO sensitivity are also registered.

[Sequence Composition]

Select multiple frames from a 4K burst file to create a sequence composition of a moving subject into one picture.



MENU → **[Playback]** → **[Sequence Composition]**

- 1 Press **◀/▶** to select the 4K photo burst files and press **[MENU/SET]**.
- 2 Select frames to combine.

Select the frames so that the moving subject will not overlap on the preceding or subsequent frames. (The sequence composition may not be created properly if the subject overlaps.)

- 1 Drag the slide bar or use **▲/▼/◀/▶** to select the frames to combine.
- 2 Press **[MENU/SET]**.
 - The selected frames are remembered, and the display goes to the preview screen.
 - Press **▲/▼** to select items and press **[MENU/SET]** to perform the following operations.
 - **[Next]**: Lets you select more frames for combining.
 - **[Reselect]**: Discards the frame selected immediately before and lets you select a different image.
- 3 Repeat steps 1 and 2 to select more frames to combine.
 - You can select 3 to 40 frames.
- 4 Press **▲/▼** to select **[Save]**, and then press **[MENU/SET]**.



- Pictures are saved in JPEG format. Recording information (Exif information) of the first frame such as shutter speed, aperture, and ISO sensitivity are also registered.

**Tips for [Sequence Composition]**

We recommend using a tripod to take pictures for [Sequence Composition].

[Clear Retouch]

- [Clear Retouch] is a setting to be used through touch operations and automatically enables touch operation.

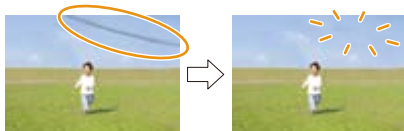

MENU → **[Playback]** → **[Clear Retouch]**

- 1 Press **◀/▶** to select a picture, and then press **[MENU/SET]**.
- 2 Drag your finger over the part you want to delete.
 - The parts to be erased are coloured.
 - To return the coloured part back to its previous state, touch **[Undo]**.

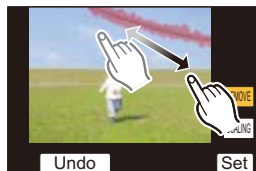

💡 Erasing details (enlarging the display)

- 1 Touch **[SCALING]**.
 - Pinching out/pinching in the screen allows you to enlarge/reduce it.
 - Dragging the screen allows you to move the enlarged part.
- 2 Touch **[REMOVE]**.
 - This will bring you back to the operation of dragging your finger over the part you want to delete. The part you want to delete can be dragged even while the picture is enlarged.



- 3 Touch **[Set]**.
- 4 Touch **[Save]** or press **[MENU/SET]**.

- Pictures may appear unnatural because the background of deleted parts is artificially created.
- For group pictures, perform [Clear Retouch] on each picture. (They cannot be edited at once.)
- When [Clear Retouch] is performed on group pictures, they are saved as new pictures separate from the original ones.

🚫 Not available in these cases:

- [Clear Retouch] is not available in the following cases:
 - When the viewfinder display is in use
 - When an HDMI micro cable is connected
- This function is not available in the following cases:
 - Motion pictures
 - 4K burst files
 - Images recorded with the Post Focus function
 - Panorama pictures
 - Pictures taken with **[RAW]**

[Text Stamp]

You can stamp recording information on recorded images.



MENU → **[Playback]** → **[Text Stamp]**

1 Select the picture. (P210)

- **[☑]** appears on screen if the picture is stamped with text.

2 Press ▲/▼ to select [Set], and then press [MENU/SET].

[Shooting Date]	Stamps the recording date.
[Name]	[👤] (Face Recognition): Name registered in [Face Recog.] will be stamped. [👶/🐾] (Baby/Pet): Name registered in [Profile Setup] will be stamped.
[Location]	Stamps the travel destination name set under [Location].
[Travel Date]	Stamps the travel date set under [Travel Date].
[Title]	Title input in the [Title Edit] will be stamped.

3 Press [↩] to return to the previous screen.

4 Press ▲/▼ to select [OK], and then press [MENU/SET].

- When you print pictures stamped with text, the date will be printed over the stamped text if you specify printing of the date at the photo shop or on the printer.
- You can set up to 100 pictures at one time in [Multi].
- The picture quality may deteriorate when text stamping is carried out.
- When you stamp pictures in a group, the stamped ones are saved separately from the original ones in the group.

ⓘ Not available in these cases:

- This function is not available in the following cases:
 - Motion pictures
 - 4K burst files
 - Images recorded with the Post Focus function
 - Panorama pictures
 - Pictures recorded without setting the clock and title
 - Pictures stamped with [Text Stamp]
 - Pictures taken with [RAW]

[Resize]

To allow easy posting to web pages, attachment to e-mail etc., picture size (number of pixels) is reduced.



MENU → **[Playback]** → **[Resize]**

Select the picture and size.

[Single] setting

- 1 Press to select the picture, and then press [MENU/SET].
- 2 Press to select the size, and then press [MENU/SET].

**[Multi] setting**

- 1 Press to select the size, and then press [MENU/SET].
- 2 Press to select the picture, and then press [MENU/SET] to set (repeat).
 - The setting is cancelled when [MENU/SET] is pressed again.
- 3 Press [DISP.] to execute.



- You can set up to 100 pictures at one time in [Multi].
- The picture quality of the resized picture will deteriorate.

Not available in these cases:

- This function is not available in the following cases:
 - Motion pictures
 - 4K burst files
 - Images recorded with the Post Focus function
 - Panorama pictures
 - Group Pictures
 - Pictures stamped with [Text Stamp]
 - Pictures taken with [RAW]

[Cropping]

You can enlarge and then clip the important part of the recorded picture.



MENU → **[Playback]** → **[Cropping]**

- 1 Press to select the picture, and then press **[MENU/SET]**.
- 2 Select the parts to be cropped.

Button operation	Touch operation	Description of operation
		Enlarges the picture
		Reduces the picture
	Drag	Moves the enlarged area

3 Press **[MENU/SET]**.

- The picture quality of the cropped picture will deteriorate.
- Crop one picture at a time when you want to crop the pictures in a picture group. (You cannot edit all pictures in a group at once.)
- When you crop pictures in a group, the cropped ones are saved separately from the original ones in the group.
- Information regarding the Face Recognition in the original picture will not be copied to images having undergone [Cropping].

Not available in these cases:

- This function is not available in the following cases:
 - Motion pictures
 - 4K burst files
 - Images recorded with the Post Focus function
 - Panorama pictures
 - Pictures stamped with [Text Stamp]
 - Pictures taken with [RAW]

[Rotate] (The picture is rotated manually.)

Rotate pictures manually in 90° steps.

- The [Rotate] function is disabled when [Rotate Disp.] is set to [OFF].

MENU →  **[Playback]** → **[Rotate]**

1 Press ◀/▶ to select the picture and then press [MENU/SET].

2 Select the rotation direction.

:

The picture rotates clockwise in steps of 90°.

:

The picture rotates counter-clockwise in steps of 90°.

**[Video Divide]**

Recorded motion picture and 4K burst files can be divided in two. It is recommended for when you want to divide a part you need with a part you do not need.

Dividing a file is permanent. Decide before you divide!

MENU →  **[Playback]** → **[Video Divide]**

1 Press ◀/▶ to select the file to divide, and then press [MENU/SET].

2 Press ▲ at the location to divide.

- You can finely adjust the location for division by pressing ◀/▶ while the file is paused.

3 Press ▼.

- The file may be lost if the card or battery is removed while processing the dividing.



 **Not available in these cases:**

- It may not be possible to divide a file at a point near the beginning or end.
- This function is not available in the following case:
 - When the recording time is short.

[Time Lapse Video]

This function allows you to create a motion picture from a picture group recorded with [Time Lapse Shot].

MENU →  **[Playback]** → **[Time Lapse Video]**

- 1 Select the [Time Lapse Shot] picture group with ◀/▶, and then press [MENU/SET].
- 2 Create a motion picture by selecting the methods for creating it.
 - Refer to P135 for details.

[Stop Motion Video]

A Motion picture is created from group pictures taken with [Stop Motion Animation].

MENU →  **[Playback]** → **[Stop Motion Video]**

- 1 Select the Stop Motion Animation group with ◀/▶, and then press [MENU/SET].
- 2 Create a motion picture by selecting the methods for creating it.
 - Refer to P138 for details.

[Rotate Disp.] (The picture is automatically rotated and displayed.)

This mode allows you to display pictures vertically if they were recorded holding the camera vertically.

MENU →  **[Playback]** → **[Rotate Disp.]** → **[ON]**

**Not available in these cases:**

- When you play back pictures on a PC, they cannot be displayed in the rotated direction unless the OS or software is compatible with Exif.
Exif is a file format for still pictures which allows recording information etc. to be added. It was established by “JEITA (Japan Electronics and Information Technology Industries Association)”.

[Picture Sort]

You can set the order in which the camera displays images during playback.

MENU →  **[Playback]** → **[Picture Sort]**

[FILE NAME]	Displays images by folder name/file name. This display format allows you to locate images in the card easily.
[DATE/TIME]	Displays images by recording date. If the card contains pictures taken with more than one camera, this display format is convenient for looking for images.

- When you insert another card, images may not be displayed by **[DATE/TIME]** first. The images will be displayed by **[DATE/TIME]** if you wait for a while.

[Delete Confirmation]

This sets which option, **[Yes]** or **[No]**, will be highlighted first when the confirmation screen for deleting a picture is displayed.

It is set to **[“No” first]** at the time of purchase.

MENU →  **[Playback]** → **[Delete Confirmation]**

[“Yes” first]	[Yes] is highlighted first, so deletion can be done quickly.
[“No” first]	[No] is highlighted first. Accidental deletion of pictures is avoided.

What you can do with the Wi-Fi®/Bluetooth® function

Controlling with a Smartphone (P237)

- Recording with a smartphone (P238)
- Playing back or saving images stored on the camera, or uploading them on social media sites (P242)

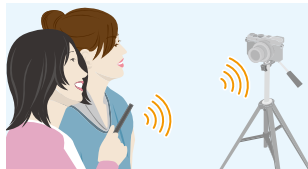

Connect to a smartphone that supports Bluetooth low energy to expand the scope of applications

- Pairing (connection setup) (P231)
- Turning on/off the camera using a smartphone (P237)
- [B] (Bulb) recording (P240)
- Transferring recorded images to a smartphone automatically (P243)
- Writing location information of a smartphone on a recorded image (P245)
- Synchronising the camera's clock with a smartphone (P246)



Displaying pictures on a TV (P247)



Printing Wirelessly (P252)



Sending images to AV device (P253)



Sending images to PC (P254)



Using Web services (P256)

These operating instructions refer to both smartphones and tablets as smartphones from this point on unless noted otherwise.

Wi-Fi function/Bluetooth function

■ Before Use

• Set the clock. (P32)

- To use the Wi-Fi function on this unit, a wireless access point or a destination device equipped with the wireless LAN function is required.

■ About the WIRELESS connection lamp

Lit blue	When the Wi-Fi/Bluetooth function is turned on or connected
Blinking blue	When sending image data by operating the camera

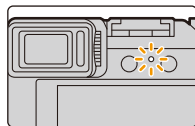

- In [Wireless Connection Lamp] in the [Setup] menu, you can set the lamp so that it will not light/flash. (P202)

■ About the [Wi-Fi] button

In these operating instructions, a function button to which [Wi-Fi] is assigned is referred to as the [Wi-Fi] button.

(By default, [Wi-Fi] is assigned to [Fn6] when the camera is in Recording Mode, while it is assigned to [Fn1] when the camera is in Playback Mode.)

- For information about the function button, refer to P50.

Steps for pressing [Wi-Fi] (in Recording Mode)

1 Touch [Fn6].



2 Touch [Fn10].



■ Operations that can be performed by pressing [Wi-Fi]

When the camera is not connected to Wi-Fi, press [Wi-Fi]. The camera will then be ready to be connected to the smartphone. You can connect the camera directly to the smartphone. (P233)

- When the camera is ready, you may find it convenient to press [DISP.] to access History, which stores previous connections, and connect quickly. (P267)

After connecting to a Wi-Fi network, you can perform the following operations by pressing [Wi-Fi]:

[Terminate the Connection]	Terminates the Wi-Fi connection.
[Change the Destination]	Terminates the Wi-Fi connection, and allows you to select a different Wi-Fi connection.
[Change Settings for Sending Images]	Refer to P250 for details.
[Register the Current Destination to Favorite]	Registering the current connection destination or the connection method, you can easily connect with the same connection method next time.
[Network Address]	(P270)

- Depending on the Wi-Fi function being used or the connection destination, you may not be able to perform some of these operations.

■ Describing method

When “select [Select a destination from History]”, etc. is described in a step, perform any of the following operations.

Button operation: Select [Select a destination from History] with the cursor button, and then press [MENU/SET].

Touch operation: Touch [Select a destination from History].

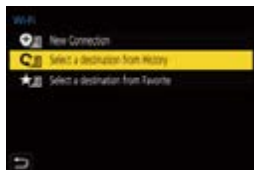

• Do not remove the memory card or battery or move to an area without any reception while sending images.

- The camera cannot be used to connect to a public wireless LAN connection.
- It is recommended to use a fully charged battery when sending images.
- When sending images on a mobile network, high packet communication fees may be incurred depending on the details of your contract.
- Pictures may not be completely sent depending on radio wave conditions. If the connection is terminated while sending pictures, pictures with missing sections may be sent.

Connecting to a smartphone

You can use a smartphone to operate the camera from a remote location.

You need to install “Panasonic Image App” (referred to as “Image App” from this point on) on your smartphone.

Installing the smartphone/tablet app “Panasonic Image App”

• OS

App for Android™: **Android 4.4 or higher**
(Android 5.0 or higher is required to use the Bluetooth function)

App for iOS: **iOS 9.0 or higher**
(The Bluetooth function cannot be used with the iPad 2)

- 1 **Connect the smartphone to a network.**
- 2 **(Android) Select “Google Play™ Store”.**
(iOS) Select “App Store”.
- 3 **Enter “Panasonic Image App” or “LUMIX” into the search box.**
- 4 **Select “Panasonic Image App”  and install it.**

- Use the latest version.
- Supported OSs are current as of September 2018 and are subject to change.
- The service may not be able to be used properly depending on the type of smartphone being used.

Refer to the support site below for details about the “Image App”.

<http://panasonic.jp/support/global/cs/dsc/>

(This Site is English only.)

- When downloading the app on a mobile network, high packet communication fees may be incurred depending on the details of your contract.
- Read the [Help] in the “Image App” menu for further details on how to operate.
- When you operate the “Image App” on the smartphone that is connected to the camera via Wi-Fi, [Help] in the “Image App” may not be displayed depending on the smartphone. In this case, after terminating the connection to the camera, reconnect the smartphone to a mobile phone network such as the 3G or LTE network or to a Wi-Fi router, and then display [Help] in the “Image App”.
- Some of the screens and information provided in these operating instructions may differ from your device depending on the supported OS and “Image App” version.

Connecting the camera to a smartphone compatible with Bluetooth low energy

You can connect the camera to a smartphone via a Bluetooth connection.

• Supported smartphones

Android: Android 5.0 or higher equipped with Bluetooth 4.0 or higher (excluding those that do not support Bluetooth low energy)

iOS: iOS 9.0 or higher (excluding the iPad 2)

■ Connecting for the first time

Pairing needs to be set up only for the first connection. After pairing is set up, a Wi-Fi connection will be made automatically.

(On the camera)

MENU → **⌘ [Setup]** → **[Bluetooth]** → **[Bluetooth]** → **[SET]** → **[Pairing]**

- The camera enters pairing standby mode and displays its device name.

(On your smartphone)

1 Start “Image App”.

- If a message is displayed indicating that the smartphone is searching for cameras, close the message.

2 Select **[Bluetooth]**.

3 Turn on the **Bluetooth**.

4 Select the device name displayed on the camera’s screen from the **[Camera enable to be registered]** list.

- Bluetooth connection between the camera and the smartphone will be made.
(For Android devices) A Wi-Fi connection will be made by selecting **[Connection]**.

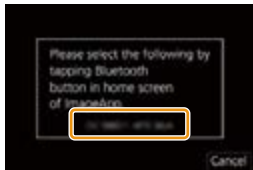

If you are using an Android device, follow the steps up to here to complete the setup. Proceed to the steps below only if you are using an iOS device (iPhone/iPod touch/iPad).

- If **[Wi-Fi Password]** (P269) is set to **[OFF]** on the camera, select **[Wi-Fi Setup]**. (At the time of purchase, **[Wi-Fi Password]** is set to **[OFF]**)
- If **[Wi-Fi Password]** is set to **[ON]** on the camera, you need to install the profile.

❶ Install the profile.

- If a pass code is set on the smartphone, you need to enter it.

❷ Press the home button to close the browser.

5 Turn on the **Wi-Fi** function in the smartphone’s setting menu.

6 On the **Wi-Fi** setting screen, select the **SSID** displayed on the camera. (the device name selected in step 4)

- If the SSID is not displayed, it may be displayed after the Wi-Fi function is turned off and on.
- When you need to change the connected device, follow the on-screen message to change the setting.

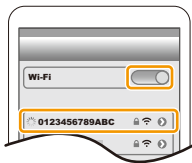

7 Start “Image App”.

- The paired smartphone will be registered as a paired device after connected via Wi-Fi.

■ Connecting to the paired smartphone (connecting for the second and subsequent times)

(On the camera)

MENU →  [Setup] → [Bluetooth] → [Bluetooth] → [ON]

(On your smartphone)

1 Start “Image App”.

- If a message is displayed indicating that the smartphone is searching for cameras, close the message.

2 Select [Bluetooth].

3 Turn on the Bluetooth.

4 Select the camera (device name) you want to connect to from the [Camera registered] list.

- Even if you set up pairing with more than one smartphone, you can only connect to one smartphone at a time.

■ Terminating the Bluetooth connection

MENU →  [Setup] → [Bluetooth] → [Bluetooth] → [OFF]

- The connection will be terminated and the camera's Bluetooth function will be deactivated.
- Even if you terminate the connection, the pairing information for it will not be deleted.

■ Deleting pairing information

(On the camera)



1 Select the menu.

MENU →  [Setup] → [Bluetooth] → [Bluetooth] → [SET] → [Delete]

2 Select the smartphone you want to delete.

(On your smartphone)

Select the camera (device name) for which to delete the pairing information from the [Camera registered] list, and delete the registration.

- [] is displayed on the recording screen during Bluetooth connection. When the Bluetooth function is enabled, but a connection is not established, [] appears translucent.
- When it takes time to set up pairing between a smartphone and a camera, delete the pairing information of both devices and register them again. This may enable the devices to be recognised properly.
- Up to 16 smartphones can be registered. If you try to register more than 16 devices, the smartphone with the oldest registration history will be replaced.
- Performing [Reset Network Settings] will delete registered device information.

Connecting the camera to a smartphone that does not support for Bluetooth low energy

Connect to a smartphone via Wi-Fi.

- You can also connect via Wi-Fi to a smartphone that supports Bluetooth low energy by following the same steps.

Connecting without using the password

You can easily establish a Wi-Fi connection on this unit without entering a password on your smartphone.

(On the camera)

MENU →  [Setup] → [Wi-Fi] → [Wi-Fi Function] → [New Connection] → [Remote Shooting & View]

Ⓐ SSID

- The information required for directly connecting your smartphone to this unit (SSID) is displayed.
- You can also display the information by pressing [Wi-Fi] on the camera.



(On your smartphone)

- 1 Turn on the Wi-Fi function in the setup menu.
- 2 On the Wi-Fi setting screen, select the SSID displayed on the camera.
- 3 Start “Image App”.
 - When the connection confirmation screen is displayed on the camera, select [Yes] to connect. (For first time connection only)



At the time of purchase, [Wi-Fi Password] is set to [OFF].

Before connecting to a Wi-Fi network, ensure that the device displayed on the connection confirmation screen is the one you actually want to connect to. When a wrong device is displayed, if you select [Yes], the camera will automatically connect to that device. We recommend that you set [Wi-Fi Password] (P269) to [ON] if, for example, there is another Wi-Fi device nearby.

Using a password to set up a connection

When [Wi-Fi Password] is set to [ON], you can enhance security by using manual entry of a QR code for password authentication.

Preparations: (On the camera) Set [Wi-Fi Password] to [ON]. (P269)

■ Using the QR code to set up a connection

(On the camera)

MENU →  [Setup] → [Wi-Fi] → [Wi-Fi Function] → [New Connection] → [Remote Shooting & View]

(A) SSID and password

(B) QR code

- The information (QR Code, SSID and Password) required for directly connecting your smartphone to this unit is displayed.
- You can also display the information by pressing [Wi-Fi] on the camera.

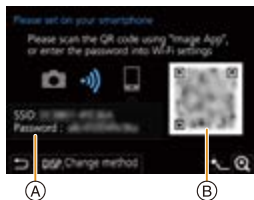

(On your smartphone)

1 Start "Image App".

2 Select [QR code].

- When the smartphone is connected to a wireless access point, it may take time to display [QR code].
- (For iOS devices) A confirmation screen will be displayed. Select [OK] to proceed.

3 Use the "Image App" to scan the QR code displayed on the screen of the camera.

- To enlarge the QR code, press [MENU/SET] on the camera.

If you are using an Android device, follow the steps up to here to complete the setup. Proceed to the steps below only if you are using an iOS device (iPhone/iPod touch/iPad).

4 Install the profile.

- If a pass code is set on the smartphone, you need to enter it.

5 Press the home button to close the browser.

6 Turn on the Wi-Fi function in the smartphone's setting menu.

7 On the Wi-Fi setting screen, select the SSID displayed on the camera.

8 Start "Image App".

- (iOS devices) Steps 1 through 5 are not required from the second time on.



Manually entering a password to set up a connection (On the camera)

MENU →  **[Setup]** → **[Wi-Fi]** → **[Wi-Fi Function]** → **[New Connection]** → **[Remote Shooting & View]**

(A) SSID and password

(B) QR code

- The information (QR Code, SSID and Password) required for directly connecting your smartphone to this unit is displayed.
- You can also display the information by pressing **[Wi-Fi]** on the camera.

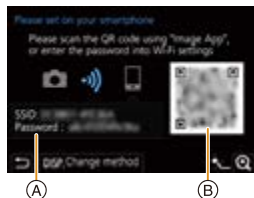

(On your smartphone)

- 1 Turn on the Wi-Fi function in the smartphone's setting menu.
- 2 On the Wi-Fi setting screen, select the SSID displayed on the camera.
- 3 Enter the password displayed on the camera into the smartphone. (For first time connection only)
- 4 Start "Image App".



Changing the Wi-Fi connection method

To change the connection method, follow the steps below:

MENU →  **[Setup]** → **[Wi-Fi]** → **[Wi-Fi Function]** → **[New Connection]** → **[Remote Shooting & View]** → **[DISP.] button**

or

Wi-Fi → **[DISP.] button** → **[New Connection]** → **[Remote Shooting & View]** → **[DISP.] button**



■ When connecting via a wireless access point ([Via Network]):

(On the camera)

- 1 Select [Via Network].
 - Follow the connection procedure described on [P264](#) to connect the camera to a wireless access point.

(On your smartphone)

- 2 Turn on the Wi-Fi function in the smartphone's setting menu.
- 3 Connect the smartphone to the wireless access point to which the camera is connected.
- 4 Start "Image App".

■ When directly connecting the camera and smartphone ([Direct]):

(On the camera)

- 1 Select [Direct].
 - Follow the connection procedure described on [P266](#) to connect the camera to the smartphone.

(On your smartphone)

- 2 Start "Image App".

Terminating the Wi-Fi connection

- 1 **Set the camera to Recording Mode.**
 - Press the shutter button halfway to return to recording mode.
- 2 **Select the camera's menu items to terminate the Wi-Fi connection.**

MENU →  [Setup] → [Wi-Fi] → [Wi-Fi Function] → [Yes]

- You can also terminate the connection by pressing [Wi-Fi] on the camera.

- 3 **On the smartphone, close "Image App".**

- When recording with [4K Pre-Burst] with the smartphone, terminate the connection only after switching to 4K Burst recording by pressing [] on the camera.



Controlling with a Smartphone

■ Required wireless connectivity mode

The wireless connectivity mode required varies depending on the function to be used after connecting to a smartphone.

Wireless connectivity required	Support for Bluetooth low energy
Bluetooth	Indicates that the function can be used with smartphones that support Bluetooth low energy.
Wi-Fi	Indicates that the function can be used with smartphones that do not support Bluetooth low energy.
Bluetooth Wi-Fi	Indicates that the function can be used with smartphones that support Bluetooth low energy. • Indicates that the function requires you to connect to a smartphone using both Bluetooth and Wi-Fi.

Turning on/off the camera with a smartphone

Wireless connectivity required: Bluetooth Wi-Fi

Even when the camera is turned off, it can be started up remotely and operated on your smartphone. You can turn on the camera to record from a remote location or view images even when the camera is in your bag.



- 1 Make a Bluetooth connection to the smartphone. (P231)
- 2 Select the camera's menu.

MENU → [Setup] → [Bluetooth] → [Remote Wakeup] → [ON]

- 3 Set the camera on/off switch to [OFF].
- 4 On the smartphone, start up the "Image App", and set the Bluetooth function to a state in which a connection can be made (standby state).
- 5 Operate the smartphone.

- 1 Select [Home].
- 2 Select [Remote operation].



- The camera automatically turns on, allowing it to make a Wi-Fi connection automatically.
 - (iOS devices) Depending on the connection status of the smartphone, you may need to change the connected device on the Wi-Fi setup screen. Follow the on-screen message on the smartphone to change the setting.

■ Turning off the camera with the smartphone

- ❶ Select [].
- ❷ Select [ OFF].

- When [Remote Wakeup] is set to [ON], the Bluetooth function continues to operate even after the camera is turned off, thus causing the battery to drain.

Taking images via a smartphone (remote recording)

Wireless connectivity required: Wi-Fi

- 1 **Connect to a smartphone. (P230)**
- 2 **Operate the smartphone.**

If the camera is already connected to the smartphone via Bluetooth, select [] → [Remote operation].

(iOS devices)

Depending on the connection status of the smartphone, you may need to change the connected device on the Wi-Fi setup screen. Follow the on-screen message on the smartphone to change the setting.

❶ Select [].



❷ Record an image.

- The recorded images are saved in the camera.
- Some settings are not available.



■ Setting the higher priority between the camera and smartphone to perform operations

MENU →  **[Setup]** → **[Wi-Fi]** → **[Wi-Fi Setup]** → **[Priority of Remote Device]**

 [Camera]	<p>Allows you to perform operations with both the camera and the smartphone.</p> <ul style="list-style-type: none"> • The camera's dial settings, etc. cannot be changed with the smartphone.
 [Smartphone]	<p>Allows you to perform operations only with the smartphone.</p> <ul style="list-style-type: none"> • The camera's dial settings, etc. can be changed with the smartphone. • To end remote recording, press any of the buttons on the camera to turn on the screen, and select [End].

- The setting of this function cannot be changed while the connection is active.
- The camera could tilt when the lens barrel extends. Make sure to secure the camera in place with a tripod or by other means.

Not available in these cases:

- In the following cases, remote recording does not work:
 - Panorama Shot Mode*
 - When using [Time Lapse Shot]
- * When [Priority of Remote Device] is set to [] ([Smartphone]), you can temporarily switch to Programme AE Mode for remote recording. The camera returns to normal operation after the remote recording has finished.

Operating the shutter button with a smartphone via a Bluetooth connection alone

Wireless connectivity required: **Bluetooth**

1 Make a Bluetooth connection to the smartphone. (P231)

2 Operate the smartphone.

① Select [].

② Select [Shutter Remote Control].

③ Take pictures.

- Refer to [Help] in the “Image App” for more details about the [Shutter Remote Control] operation of the “Image App”.
- [Shutter Remote Control] is available when the camera on/off switch is set to [ON].
- The live view image of the camera cannot be monitored on the smartphone.

• When the camera turns off after [Sleep Mode] is activated during recording, you can reselect [Shutter Remote Control] on the smartphone to turn it on again. (The following settings are required.)

- [Remote Wakeup]: [ON]
- [Auto Transfer]: [OFF]



About [B] (Bulb)



You can perform [B] (Bulb) recording by setting the shutter speed dial to [T] (Time) in Manual Exposure Mode. (Up to 30 minutes)

This function is useful when you take pictures of stars in the night sky or a night scene, since the shutter can be kept open from start of recording to end of recording.

Operate the smartphone

① Press [] to start recording (Press and hold [])

② Release your finger from [] to end recording

- Slide [] in the direction of [LOCK] to record with the shutter button fixed in the fully pressed condition. (Slide [] back in the opposite direction or press the shutter button of the camera to end recording.)
- If Bluetooth is disconnected during the [B] (Bulb) recording, reconnect Bluetooth and perform the operation to end recording using the smartphone.
- [T] (Time) will be displayed on the camera screen.





■ Reducing the time to recover from [Sleep Mode]

Select the smartphone function to be used as a priority function when waking the camera from [Sleep Mode] with a smartphone.

Preparation:

Set [Bluetooth] and [Remote Wakeup] to [ON]. (P237)

MENU →  **[Setup]** → **[Bluetooth]** → **[Returning from Sleep Mode]**

	[Remote / Transfer Priority]	Shortens the time required to wake the camera with [Remote operation] or [Transfer image].
	[Shutter Remote Priority]	Shortens the time required to wake the camera with [Shutter Remote Control].

Playing back/saving images stored on the camera, or uploading them on social media sites

Wireless connectivity required: Wi-Fi

- 1 Connect to a smartphone. (P230)
- 2 Operate the smartphone.

If the camera is already connected to the smartphone via Bluetooth, select [] → [Remote operation].

(iOS devices)

Depending on the connection status of the smartphone, you may need to change the connected device on the Wi-Fi setup screen. Follow the on-screen message on the smartphone to change the setting.

- 1 Select [].

- You can switch the images to be displayed by selecting the icon (A) on the top left of the screen. To display images stored in the camera, select [LUMIX].

(To play back the image)

- 2 Touch the image to enlarge it.

- When you play a motion picture, image quality differs from that of the actual recorded motion picture. In addition, depending on the smartphone or conditions of use, the image quality may deteriorate or the sound may skip during motion picture or picture playback.

(To save the image or upload it on a social media site or other web service)

- 3 Touch and hold and then drag the image.

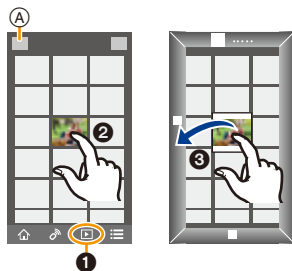

- An OS version of Android 7.0 or higher or iOS 10.0 or higher is required to save pictures in RAW format.
- Depending on the smartphone or its OS version, pictures in RAW format may not be displayed correctly.
- You cannot save the following types of images:
 - Motion pictures in AVCHD and 4K formats
 - 4K burst files
 - Images recorded with the Post Focus function



Transferring recorded images to a smartphone automatically

Wireless connectivity required: **Bluetooth** **Wi-Fi**

The camera automatically transfers recorded images to a Bluetooth-connected smartphone via Wi-Fi.

- 1 **Make a Bluetooth connection to the smartphone. (P231)**
- 2 **Select the camera's menu.**

MENU →  **[Setup]** → **[Bluetooth]** → **[Auto Transfer]** → **[ON]**

- If a confirmation screen is displayed on the camera asking you to terminate the Wi-Fi connection, select [Yes] to terminate it.
- 3 **On the smartphone, select [Yes] (Android devices) or [Wi-Fi Setup] (iOS devices).**
 - The camera automatically makes a Wi-Fi connection.
 - (iOS devices) Follow the on-screen message on the smartphone to change the connected device on the Wi-Fi setup screen.
 - 4 **Check the send settings on the camera, and select [Set].**
 - To change the send setting, press [DISP]. (P250)
 - The camera will enter a mode where it can automatically transfer images and  will be displayed on the recording screen. (If it is not displayed, images cannot be transferred automatically. Check the status of the Wi-Fi connection to the smartphone.)
 - 5 **Take pictures on the camera.**
 - Every time you take a picture, it is automatically sent to a specified device.
 - While sending a file,  is displayed on the recording screen.



If you set [Auto Transfer] to [ON], the camera and the smartphone will be connected via Wi-Fi/Bluetooth and automatic transfer will be enabled the next time you turn on the camera and start "Image App" on the smartphone.

■ To stop the automatic transfer of images

Select [OFF] in step 2.

- A confirmation screen is displayed, asking you to terminate the Wi-Fi connection.

- **When [Auto Transfer] is set to [ON], [Wi-Fi Function] in [Wi-Fi] in the [Setup] menu cannot be used.**
- If the camera turns off during image transfer and the file transfer is cancelled, it will resend the files as soon as it is turned on again.
 - You may not be able to resend the files that did not get delivered if there is a change in their storage status. For example, if you replace the card before turning on the camera again, the files may not be resent.
 - If the number of files that did not get delivered is large, it may not be possible to resend all of the files.
- An OS version of Android 7.0 or higher or iOS 10.0 or higher is required to save pictures in RAW format.
- Depending on the smartphone or its OS version, pictures in RAW format may not be displayed correctly.
- You cannot automatically transfer the following types of images:
 - Motion pictures
 - 4K burst files
 - Images recorded with the Post Focus function

Writing location information of a smartphone on a recorded image

Wireless connectivity required: **Bluetooth**

The smartphone sends its location information to the camera via Bluetooth, and the camera performs recording while writing the acquired location information.

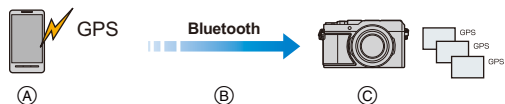

- (A) The smartphone acquires location information.
- (B) The smartphone sends the location information.
- (C) The camera performs recording while writing the location information.

Preparations:

Enable the GPS function on the smartphone.

- 1 **Make a Bluetooth connection to the smartphone. (P231)**
- 2 **Select the camera's menu.**

MENU → **⌘ [Setup]** → **[Bluetooth]** → **[Location Logging]** → **[ON]**

- The camera will enter a mode where location information can be recorded and **[GPS]** will be displayed on the recording screen.

- 3 **Take pictures on the camera.**

- Location information will be written to the recorded pictures.

When **[GPS]** appears translucent

Location information is not acquired, so data cannot be written. Positioning with the GPS on the smartphone may not be possible if the smartphone is in a location such as a building or a bag.

- Move the smartphone to a location where positioning performance can be optimised, such as one that offers a wide view of the sky, to try positioning.
- Refer to the operating instructions of your smartphone.

- Images with location information are indicated with **[GPS]**.
- The smartphone drains its battery faster while acquiring location information.
- **Be sure to pay special attention to the privacy, the likeness rights, etc. of the subject when you use this function. Use at your own risk.**



Not available in these cases:

- Location information is not written to AVCHD motion pictures.

Synchronising the camera's clock with a smartphone

Wireless connectivity required: **Bluetooth**

Synchronise the [Clock Set] setting and the [Home] or [Destination] setting in [World Time], which are all located in the [Setup] menu of the camera, with the corresponding settings of a smartphone.

- 1 Make a Bluetooth connection to the smartphone. (P231)
- 2 Select the camera's menu.

MENU → ⚙ [Setup] → [Bluetooth] → [Auto Clock Set] → [ON]



MENU



Displaying pictures on a TV

You can display pictures on a TV that supports DLNA (DMR).

1 Select the menu.

MENU →  [Setup] → [Wi-Fi] → [Wi-Fi Function] → [New Connection] → [Playback on TV]

2 Select [Via Network] or [Direct], and connect. (P263, 266)

3 Select a device you want to connect.

- When the connection is established, the screen is displayed.

4 Take or play back still pictures on this unit.

- Set the menu to terminate the connection.

MENU →  [Setup] → [Wi-Fi] → [Wi-Fi Function] → [Yes]
(You can also terminate the connection by pressing [Wi-Fi].)

- Pictures displayed using the Wi-Fi function cannot be output in 4K resolution. To output them in 4K resolution, connect the camera and TV with an HDMI micro cable. (P271)
- When a TV is connected to the camera, the TV screen may temporarily return to the status before the connection. Pictures are displayed again on the TV if you take or play back pictures.
- The [Effect] and [Sound] settings for slide shows are not applied to the TV.

Not available in these cases:

- Motion pictures and 4K burst files cannot be played back.
- Images displayed on certain screens of the camera (multi playback screen, etc.) are not displayed on the TV.
- When [Auto Transfer] in [Bluetooth] is set to [ON], [Wi-Fi Function] is not available.

Sending images

When sending pictures, first select [New Connection], then select the method of sending pictures.

MENU →  [Setup] → [Wi-Fi] → [Wi-Fi Function] → [New Connection] → [Send Images While Recording] or [Send Images Stored in the Camera]

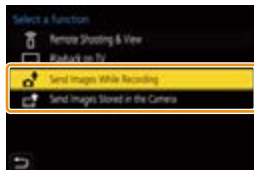

■ Images that can be sent

Destination	JPEG	RAW	MP4 ^{*1}	AVCHD ^{*1,2}	4K Burst File ^{*1} Images recorded with the Post Focus function ^{*1}
[Smartphone]	○	○ ^{*3}	○ ^{*4}	—	—
[PC]	○	○	○	○	○
[Cloud Sync. Service]	○	—	○ ^{*4}	—	—
[Web service]	○	—	○ ^{*4}	—	—
[AV device]	○	—	—	—	—
[Printer] ^{*1}	○	—	—	—	—

*1 Sending by [Send Images While Recording] is not available.

*2 Cannot be sent if the file size is over 4 GB.

*3 An OS version of Android 7.0 or higher or iOS 10.0 or higher is required.

*4 Excluding 4K motion pictures

- Some images may not be played back or sent depending on the device.
- For details about playback of images, refer to the operating instructions for the destination device or the Web service.

■ Send Images While Recording

A picture can be automatically sent to a specified device every time you take it.

- While sending a file,  is displayed on the recording screen.
- Set the menu to terminate the connection.

MENU →  [Setup] → [Wi-Fi] → [Wi-Fi Function] → [Yes]

- You cannot change the sending settings while sending pictures.

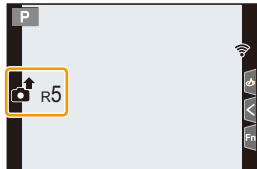

- Since the camera gives priority to recording, sending may take longer during the recording.
- If you turn off the camera or terminate the Wi-Fi connection before the transmission is completed, unsent files will not be resent.
- You may not be able to delete files or use the playback menu while sending.



Not available in these cases:

- If you set [Time Lapse Shot], the Wi-Fi connection is terminated and you cannot use this function.

Send Images Stored in the Camera

Images can be selected and sent after recording.

[Single Select] setting

- 1 Select the picture.
- 2 Select [Set].



[Multi Select] setting

- 1 Select the picture. (repeat)
 - The setting is cancelled when the picture is selected again.
- 2 Select [OK].
 - To close the connection, select [Exit].

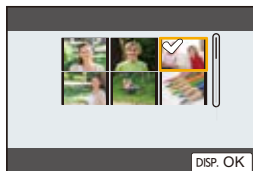

Not available in these cases:

- Images recorded with another device and images modified or edited on a PC may not be sent.

■ Changing the settings for sending images

After the connection is established, you can change the send settings by pressing [DISP].

[Size]	Resize the image to send. [Original]/[Auto]/[Change] ([M], [S] or [VGA]) • You can set this to [Auto] if the destination is [Web service]. It changes the image size according to the status of the destination.
[File Format] (Destination: [Smartphone], [PC])	[JPG]/[RAW+JPG]/[RAW]
[Delete Location Data] (Destination: [Cloud Sync. Service], [Web service])	Deletes the location information from images before sending them. [ON]/[OFF]
[Cloud Limit] (Destination: [Cloud Sync. Service])	Sets the operation to be performed when the Cloud Folder runs out of free space. [ON]: Do not send images. [OFF]: Delete images from the oldest ones, then send new images.

Sending images to a smartphone

Preparations:

- Install the “Image App” in advance. (P230)

1 Select the menu.

MENU →  [Setup] → [Wi-Fi] → [Wi-Fi Function] → [New Connection] → [Send Images While Recording] or [Send Images Stored in the Camera] → [Smartphone]

2 Select [Via Network] or [Direct], and connect. (P263, 266)

(On your smartphone)

When connecting with [Via Network]:

- 1 Turn on the Wi-Fi function.
- 2 Select the wireless access point.
- 3 Start “Image App”.

When connecting with [WPS Connection] in [Direct]:

- 1 Start “Image App”.

When connecting with [Manual Connection] in [Direct]:

- 1 Turn on the Wi-Fi function.
- 2 Select the SSID that matches the one displayed on the screen of this unit.
- 3 Start “Image App”.

3 Select a device you want to connect.

4 Check the send settings, and select [Set].

- To change the send setting, press [DISP.]. (P250)

5 When [Send Images While Recording] has been selected

Take pictures. (P248)

When [Send Images Stored in the Camera] has been selected

Select the picture. (P249)

 **Not available in these cases:**

- When [Auto Transfer] in [Bluetooth] is set to [ON], [Wi-Fi Function] is not available.

Printing Wirelessly

You can print pictures on printers that support PictBridge (wireless LAN)*.

* Compliant with the DPS over IP standards.

- For details on the PictBridge (wireless LAN-compatible) printer, contact the respective company.

1 Select the menu.

MENU →  [Setup] → [Wi-Fi] → [Wi-Fi Function] → [New Connection] → [Send Images Stored in the Camera] → [Printer]

2 Select [Via Network] or [Direct], and connect. (P263, 266)

3 Select a printer you want to connect.

4 Select pictures, and then print.

- The procedure for selecting pictures is the same as the one for when the USB connection cable is connected. (P280)
 - To terminate the connection, press .
- (You can also terminate the connection by pressing [Wi-Fi].)



Not available in these cases:

- When [Auto Transfer] in [Bluetooth] is set to [ON], [Wi-Fi Function] is not available.

Sending images to AV device

You can send pictures and motion pictures to an AV device (home AV device) that supports DLNA, such as a recorder.

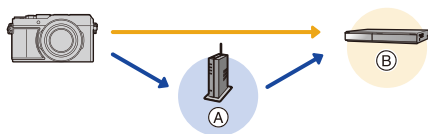

(A) Wireless access point

(B) Home AV device

1 Select the menu.

MENU → ⚙ [Setup] → [Wi-Fi] → [Wi-Fi Function] → [New Connection] → [Send Images While Recording] or [Send Images Stored in the Camera] → [AV device]

2 Select [Via Network] or [Direct], and connect. (P263, 266)

3 Select a device you want to connect.

4 Check the send settings, and select [Set].

- To change the send setting, press [DISP.]. (P250)

5 When [Send Images While Recording] has been selected

Take pictures. (P248)

When [Send Images Stored in the Camera] has been selected

Select the picture. (P249)

- Sending may fail depending on the operational status of the AV device. Also, sending may take a while.



Not available in these cases:

- When [Auto Transfer] in [Bluetooth] is set to [ON], [Wi-Fi Function] is not available.

Sending images to PC

Preparations:

- Turn the computer on.
- Prepare folders for receiving images on the PC. (P254)
- If the workgroup of the destination PC has been changed from the standard setting, change the setting of this unit in [PC Connection]. (P269)

■ To create a folder that receives images

- Create a PC account name (up to 254 characters) and password (up to 32 characters) consisting of alphanumeric characters. An attempt to create a receive folder may fail if the account name includes non-alphanumeric characters.

When using "PHOTOfunSTUDIO"

- 1 Install "PHOTOfunSTUDIO" to the PC. (P275)
- 2 Create a folder that receives images with "PHOTOfunSTUDIO".
 - For details, refer to the operating instructions of "PHOTOfunSTUDIO" (PDF).

When not using "PHOTOfunSTUDIO"

(For Windows)

Supported OS: Windows 10/Windows 8.1/Windows 8/Windows 7

Example: Windows 7

- 1 Select a folder you intend to use for receiving, then right-click.
- 2 Select [Properties], then enable sharing of the folder.
 - For details, refer to the operating instructions of your PC or Help on the OS.

(For Mac)

Supported OS: OS X v10.5 to v10.11, macOS 10.12, macOS 10.13

Example: OS X v10.8

- 1 Select a folder you intend to use for receiving, then click on the items in the following order.
[File] → [Get Info]
- 2 Enable sharing of the folder.
 - For details, refer to the operating instructions of your PC or Help on the OS.

■ Sending images to the PC

1 Select the menu.

MENU →  [Setup] → [Wi-Fi] → [Wi-Fi Function] → [New Connection] → [Send Images While Recording] or [Send Images Stored in the Camera] → [PC]

2 Select [Via Network] or [Direct], and connect. (P263, 266)

3 Enter the computer name (NetBIOS name for Mac) for the PC you want to connect to.

4 Select the folder you want to send.

5 Check the send settings, and select [Set].

- To change the send setting, press [DISP.]. (P250)

6 When [Send Images While Recording] has been selected

Take pictures. (P248)

When [Send Images Stored in the Camera] has been selected

Select the picture. (P249)

- Folders sorted by sent date will be created in the destination folder, and images will be saved there.
- If the screen for a user account and password entry appears, enter the one you set on your PC.
- When the computer name (NetBIOS name for Mac) contains a space (blank character), etc., it may not be recognised.
In that case, we recommend changing the name to one consisting only of 15 or less alphanumeric characters.
- When the firewall of the OS, security software, etc. is enabled, connecting to the PC may not be possible.



Not available in these cases:

- When [Auto Transfer] in [Bluetooth] is set to [ON], [Wi-Fi Function] is not available.

Using Web services

You can send pictures and motion pictures to a social media site, etc. via "LUMIX CLUB". By selecting settings so that pictures and motion pictures are automatically transferred to a cloud sync service you can receive the transferred pictures and motion pictures on a PC or smartphone.

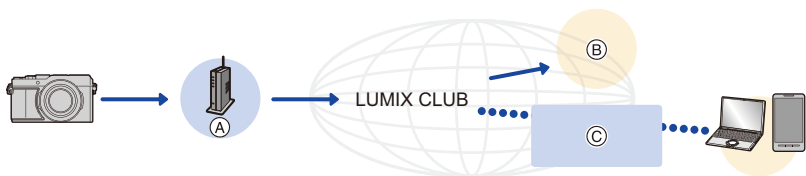

(A) Wireless access point

(B) Web service

(C) Cloud Sync Service

When sending images to web service

Preparations:

- Register to "LUMIX CLUB". (P260)
- To send images to a web service, register the web service. (P257)

- Images uploaded to the web service cannot be displayed or deleted with this camera.
- If sending images fails, a report email outlining the failure will be sent to the email address registered with "LUMIX CLUB".
- **Images may contain personal information that can be used to identify the user, such as a title, the time and date when the images was taken, and the location where the image was taken. Check this information before uploading images to web services.**

- Panasonic assumes no responsibility for the damages resulting from the leakage, loss, etc. of images uploaded on web services.
- When uploading images to the web service, do not delete images from this camera, even after they have finished sending, until you have checked that they have been properly uploaded to the web service. Panasonic assumes no responsibility for the damages resulting from the deletion of images stored in this unit.

Registering the WEB service to “LUMIX CLUB”

Check the “FAQ/Contact us” on the following site for compatible web services.

https://lumixclub.panasonic.net/eng/c/lumix_faqs/

Preparation:

Make sure that you have created an account on the web service you want to use, and have the login information available.

- 1 **Connect to the “LUMIX CLUB” site using a smartphone or computer.**
<https://lumixclub.panasonic.net/eng/c/>
- 2 **Enter your “LUMIX CLUB” login ID and password and log in to the service.**
- 3 **If your email address has not been registered to the “LUMIX CLUB” yet, register it.**
- 4 **Select and register the cloud storage service you want to use in Web service link settings.**
 - Follow the on-screen instructions to operate.

Sending images

- 1 **Select the menu.**

MENU → **⌂ [Setup]** → **[Wi-Fi]** → **[Wi-Fi Function]** → **[New Connection]** → **[Send Images While Recording]** or **[Send Images Stored in the Camera]** → **[Web service]**

- 2 **Select [Via Network], and connect. (P263)**
- 3 **Select a web service.**
- 4 **Check the send settings, and select [Set].**
 - To change the send setting, press [DISP]. (P250)

- 5 **When [Send Images While Recording] has been selected**

Take pictures. (P248)

When [Send Images Stored in the Camera] has been selected

Select the picture. (P249)



Not available in these cases:

- When [Auto Transfer] in [Bluetooth] is set to [ON], [Wi-Fi Function] is not available.

■ Sending images in the camera to a web service with simple operations

1 Display an image.

2 Press ▼.

(When group pictures are selected, press ▲, and select [Upload(Wi-Fi)] or [Upload All(Wi-Fi)].)

• The same operation can be performed by touching [↕].

(When group pictures are selected, select [Upload(Wi-Fi)] or [Upload All(Wi-Fi)] after touch [↕], [↕], [↕], [↕], or [↕], and then touch [SUB MENU].)

• If a screen is displayed asking you to select the connection method: (P264)

• If a screen is displayed asking you to acquire a new login ID: (P260)

3 Select [Yes] on the confirmation screen.

4 Select a web service.

5 Check the send settings, and select [Set].

• Step 4, 5 are not necessary when you continue to send another image.

• To change the send setting, press [DISP]. (P250)

• To terminate the connection, press [MENU/SET] or operate other controls to exit the playback screen. You can also terminate the connection by pressing [Wi-Fi]. (P229)



To change the settings for sending images or web service

Terminate the Wi-Fi connection, and follow step 1 and onwards again.

• You can also change the send settings by pressing [Wi-Fi] while using a Wi-Fi connection. (P229)

• When there are no available connections to wireless access points in History:

Select the connection method and connect the camera to a wireless access point. (P264)

• When you are not registered to the “LUMIX CLUB”:

Acquire a login ID and set a password. (P260)

• When group pictures are displayed continuously, all pictures in the group will be sent. When group pictures are displayed one by one, the currently displayed picture will be sent.

When sending images to [Cloud Sync. Service]

Preparation:

- Register to the “LUMIX CLUB”. (P260)
- Set up cloud synchronisation. (Use “PHOTOfunSTUDIO” on a PC or “Image App” on a smartphone.)

■ Using [Cloud Sync. Service] (As of September 2018)

- Sent images are temporarily saved in the cloud folder so that they can be synchronised with your device, such as a PC or a smartphone.
- A Cloud Folder stores transferred images for 30 days (up to 1000 pictures).
Be aware that images will be deleted automatically in the following cases:
 - When over 30 days have passed since the transfer
(Images may be deleted even within 30 days if downloaded to all of the specified devices.)
 - When the number of images exceeds 1000 (This applies depending on the [Cloud Limit] (P250) setting.)

1 Select the menu.

MENU →  [Setup] → [Wi-Fi] → [Wi-Fi Function] → [New Connection] → [Send Images While Recording] or [Send Images Stored in the Camera] → [Cloud Sync. Service]

2 Select [Via Network], and connect. (P263)

3 Check the send settings, and select [Set].

- To change the send setting, press [DISP.]. (P250)

4 When [Send Images While Recording] has been selected

Take pictures. (P248)

When [Send Images Stored in the Camera] has been selected

Select the picture. (P249)



Not available in these cases:

- When [Auto Transfer] in [Bluetooth] is set to [ON], [Wi-Fi Function] is not available.

About the [LUMIX CLUB]

Acquire a "LUMIX CLUB" login ID (free).

Refer to the "LUMIX CLUB" site for details.

<https://lumixclub.panasonic.net/eng/c/>

Please note:

- The service may be suspended due to regular maintenance or unexpected troubles, and the service contents may be changed or added, without prior notice to the users.
- The service may be stopped in whole or in part with a reasonable period of advance notice.

Acquiring a login ID ([New account])

1 Select the menu.

MENU →  [Setup] → [Wi-Fi] → [Wi-Fi Setup] → [LUMIX CLUB] → [Set/Add Account] → [New account]

- Connect to the network.
Proceed to the next page by selecting [Next].
- ### 2 Select the method for connecting to a wireless access point, and set. (P264)
- Proceed to the next page by selecting [Next].
- ### 3 Read through the "LUMIX CLUB" terms of use and select [Agree].
- Switch pages: ▲/▼
 - Enlarge the display (2×): Rotate the zoom lever to the [T] side. (Rotate it to the [W] side to return to 1×.)
 - Move the position of the enlarged display: ▲/▼/◀/▶
 - Cancel without registering information: [↵]
- ### 4 Enter a password.
- Enter any combination of 8 to 16 characters and numbers for the password.
 - For information on how to enter characters, refer to P56.
- ### 5 Check the login ID and select [OK].
- **Be sure to make a note of the login ID and password.**
 - The login ID (12-digit number) will be displayed automatically.
When logging in to the "LUMIX CLUB" with a computer, you only need to enter the numbers.

Checking/changing the login ID and password ([Set Login ID])

Preparation:

When using the acquired login ID, check the ID and password.

To change the "LUMIX CLUB" password on the camera, access the "LUMIX CLUB" website from your smartphone or PC and change the "LUMIX CLUB" password in advance.

1 Select the menu.

MENU →  **[Setup]** → **[Wi-Fi]** → **[Wi-Fi Setup]** → **[LUMIX CLUB]** → **[Set/Add Account]** → **[Set Login ID]**

- The login ID and password are displayed.
- The password is displayed as "★".

2 Select the item to change.

3 Enter the login ID or password.

- For information on how to enter characters, refer to [P56](#).
- Enter the new password you have created on your smartphone or PC into the camera.

4 Select [Exit].

To set the same login ID for the camera and the smartphone

Setting the same login ID on this unit and your smartphone is convenient for sending images on this unit to other devices or web services.

■ When either this unit or the smartphone has acquired the login ID:

- 1 Connect this unit to the smartphone. ([P230](#))
- 2 From the "Image App" menu, set the common login ID.

- A screen for setting a common login ID may be displayed after the camera and the smartphone are connected.

■ When this unit and the smartphone have acquired different login IDs:

Change the login ID and password of either device.

- To change the camera's login ID and password ([P261](#))

Check the “LUMIX CLUB” terms of use

Check the details if the terms of use have been updated.

MENU →  [Setup] → [Wi-Fi] → [Wi-Fi Setup] → [LUMIX CLUB] → [Terms of use]

Deleting your login ID/“LUMIX CLUB” account

Delete the login ID from the camera when transferring it to another party or disposing of it. You can also delete your “LUMIX CLUB” account.

• Changes and other actions to login IDs can only be made to the login ID acquired with the camera.

1 Select the menu.

MENU →  [Setup] → [Wi-Fi] → [Wi-Fi Setup] → [LUMIX CLUB] → [Delete account]

• The message is displayed. Select [Next].

2 Select [Yes] in the login ID delete confirmation screen.

• The message is displayed. Select [Next].

3 Select [Yes] on the confirmation screen for deleting the “LUMIX CLUB” account.

• The message is displayed. Select [Next].

• To continue without deleting the account, select [No]. The login ID will be deleted.

4 Select [OK].

About Wi-Fi connections

The following types of connections are available.

MENU →  **[Setup]** → **[Wi-Fi]** → **[Wi-Fi Function]**

[New Connection]

This makes a connection after a Wi-Fi function and send destination is selected. When a screen similar to the one below is displayed, select the connection method.

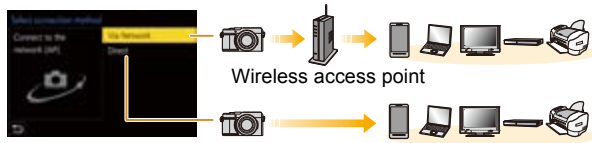

- **[Via Network] (P264):**
Makes a connection via a wireless access point.
- **[Direct] (P266):**
Connects your device and the camera directly.

[Select a destination from History]/[Select a destination from Favorite]

Connection is made using the same settings as the previous time. (P267)

Connecting via a wireless access point ([Via Network])

Select a connection method to the wireless access point.

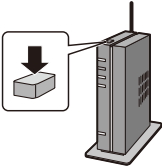
<p>[WPS (Push-Button)]</p>	<p>Save push button type wireless access point that is compatible with Wi-Fi Protected Setup™ with a WPS mark.</p> <p>Press the wireless access point WPS button until it switches to WPS mode. e.g.:</p> 
<p>[WPS (PIN code)]</p>	<p>Register a PIN code type wireless access point with a WPS mark that supports Wi-Fi Protected Setup.</p> <ol style="list-style-type: none"> 1 Select the wireless access point on the camera. 2 Enter the PIN code displayed on the camera screen into the wireless access point. 3 Press [MENU/SET] of the camera.
<p>[From List]</p>	<p>Select this option when you are not sure about the WPS compatibility, or when you want to search for and connect to a wireless access point. (P265)</p>

- Except for the first-time connection, the camera will connect to the previously-used wireless access point.
To change the connection destination, press [DISP].
- WPS refers to a function that allows you to easily configure the settings related to the connection and security of wireless LAN devices.
Refer to the operating instructions for the wireless access point for details about how to operate the WPS function and whether it is supported.

If you are not sure about the WPS compatibility ([From List])

Search for available wireless access points.

- Confirm encryption key of the wireless access point if the network authentication is encrypted.

1 Select the wireless access point.

- To search for wireless access points again, press [DISP].
- If no wireless access point is found, refer to “When connecting with [Manual Input]” on [P265](#).

**2 (If network authentication is encrypted)****Enter the encryption key.**

- For information on how to enter characters, refer to [P56](#).

■ When connecting with [Manual Input]

- Check the SSID, authentication type, encryption type, and encryption key of the wireless access point to be connected.

- On the screen displayed in step **1** of “If you are not sure about the WPS compatibility ([From List])”, select [Manual Input].
- Enter the SSID of the wireless access point you are connecting to, then select [Set].
 - For information on how to enter characters, refer to [P56](#).
- Select the network authentication type.

[WPA2-PSK]	Supported encryption methods: [TKIP], [AES]
[WPA2/WPA-PSK]	
[No Encryption]	—

- (When an option other than [No Encryption] is selected)
Enter the encryption key.

- Check the wireless access points instruction manual and settings when saving a wireless access point.
- If no connection can be established, the wireless access point's radio waves may be too weak.

Refer to “Message Display” ([P290](#)) and “Troubleshooting” ([P292](#)) for details.

- Depending on your environment, transmission speed between the camera and wireless access point may decrease. In addition, the wireless access point may not be available for use.

Connecting the camera and another device directly ([Direct])

<p>[WPS Connection]</p>	<p>[WPS (Push-Button)]</p> <ol style="list-style-type: none"> 1 On the camera, select [WPS (Push-Button)]. 2 Set the device to WPS mode. <ul style="list-style-type: none"> You can wait longer for a connection by pressing [DISP.] on this camera. <hr/> <p>[WPS (PIN code)]</p> <ol style="list-style-type: none"> 1 On the camera, select [WPS (PIN code)]. 2 Enter the PIN code of the device into this camera.
<p>[Manual Connection]</p>	<p>Enter the SSID and password displayed on the camera.</p> <ul style="list-style-type: none"> If the destination is set to [Smartphone], the password is not displayed. Select the SSID to establish a connection. (P233)

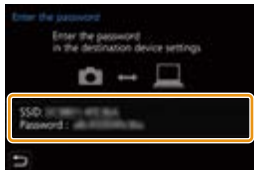

- Please also refer to the operating instructions of the device to be connected.

Connecting quickly with the same settings as the previous ones ([Select a destination from History])/([Select a destination from Favorite])

Wi-Fi connection history is saved in History when the Wi-Fi function is used. Connecting from History allows you to easily connect with the same Wi-Fi settings as used previously.

- If the settings of the device to connect to have been changed, it may not be possible to connect to the device.

1 Select the menu.

MENU → ⌘ [Setup] → [Wi-Fi] → [Wi-Fi Function]	
[Select a destination from History]	Connects with previously-used settings.
[Select a destination from Favorite]	Connects with settings registered in Favourites.

2 Select the desired connection setting.

- You can display details of the connection by pressing [DISP].

■ Registering History items to Favourites

1 Select the menu.

MENU → ⌘ [Setup] → [Wi-Fi] → [Wi-Fi Function] → [Select a destination from History]
--

2 Select the item you wish to register and press ►.

3 Enter a registration name.

- For information on how to enter characters, refer to [P56](#).
- A maximum of 30 characters can be entered. A two-byte character is treated as two characters.

■ Editing items registered in Favourites

- 1 Select the menu.

MENU → ⚙ [Setup] → [Wi-Fi] → [Wi-Fi Function] →
[Select a destination from Favorite]

- 2 Select the Favourites item you wish to edit and press ►.

[Remove from Favorite]	—
[Change the Order in Favorite]	Select the destination.
[Change the Registered Name]	• How to enter text (P56)

- Because the number of items that can be saved in History is limited, register frequently-used connection settings to Favourites.
- Performing [Reset Network Settings] deletes data registered in History and Favourites.
- If the device you want to connect to (smartphone, etc.) is connected to a wireless access point other than the camera, you cannot connect the device to the camera using [Direct]. Change the Wi-Fi settings of the device you want to connect to so that the access point to be used is set to the camera.
You can also select [New Connection] and reconnect the devices. (P230)
- It may be difficult to establish a connection to a network used by many devices. In that case, connect by [New Connection].

[Wi-Fi Setup] Menu

Configure the settings required for the Wi-Fi function.
The settings cannot be changed when connected to Wi-Fi.

MENU →  **[Setup]** → **[Wi-Fi]** → **[Wi-Fi Setup]**

[Priority of Remote Device]

This sets the higher priority between the camera and smartphone to perform operations during remote recording. (P239)

[Wi-Fi Password]

You can improve security by enabling password entry for a direct connection to a smartphone.

[ON]	Connects the camera and a smartphone using an SSID and password. (P234)
[OFF]	Connects the camera and a smartphone using an SSID. (P233)

• When [ON] is selected, you can also set up a connection by scanning a QR code.

[LUMIX CLUB]

Acquires or changes the “LUMIX CLUB” login ID. (P260)

[PC Connection]

You can set the workgroup.

To send images to a PC, a connection to the same workgroup as the destination PC is required.

(The default setting is “WORKGROUP”.)

- 1 Press [MENU/SET].
- 2 Enter the workgroup of the connecting PC.
 - For information on how to enter characters, refer to P56.

• To reset to the default setting, press [DISP].

[Device Name]

You can change the name (SSID) of this unit.

- ❶ Press [DISP].
- ❷ Enter the desired device name.
 - For information on how to enter characters, refer to [P56](#).
 - A maximum of 32 characters can be entered.

[Wi-Fi Function Lock]

To prevent incorrect operation and use of the Wi-Fi function by a third party and to protect saved personal information, we recommend protecting the Wi-Fi function with a password.

[Setup]	Enter any 4-digit numbers as the password. • For information on how to enter characters, refer to P56 .
[Cancel]	Cancel the password.

- Once a password is set, you are required to enter it each time you use the Wi-Fi function.
- If you forget the password, you can reset it with [Reset Network Settings] in the [Setup] menu.

[Network Address]

Displays the MAC address and IP address of this unit.

- A MAC Address is a unique address that is used to identify network equipment.
- IP address refers to a number that identifies a PC connected to a network such as the Internet. Usually, the addresses for homes are automatically assigned by the DHCP function such as a wireless access point. (Example: 192.168.0.87)

Watching/Saving 4K Motion Pictures on an External Device

Watching motion pictures in 4K

■ Playing Back on a TV Screen

You can enjoy finely-detailed 4K motion pictures by connecting the camera and a TV that supports 4K motion picture and playing back 4K motion pictures recorded with the camera. Although the output resolution will be lower, you can also play them back by connecting to a device that does not support 4K motion picture, such as a high-definition TV.

Preparation:

- Set [HDMI Mode (Play)] (P206) to [AUTO] or a resolution of [4K/25p].
- When connecting to a TV that does not support 4K motion picture, select [AUTO].



Connect the camera and a 4K-compatible TV with an HDMI micro cable, and display the playback screen. (P272)

- The TV input will switch automatically and the playback screen will be displayed when you set [VIERA Link] to [ON] and connect to a VIERA Link compatible TV. Refer to P273 for details.
- Read the operating instructions for the TV.

■ Watching on a PC

To play back 4K motion pictures on a PC, use the software "PHOTOfunSTUDIO".

- To play back and edit motion pictures in 4K, you need a high-performance PC environment.
- Refer to the operating instructions of "PHOTOfunSTUDIO" (PDF).



Storing 4K motion pictures

You cannot dub 4K motion pictures to Blu-ray discs and DVDs with Panasonic recorders.

■ Storing on a PC

Use the software "PHOTOfunSTUDIO" to import 4K motion pictures to a PC.

- Refer to the operating instructions of "PHOTOfunSTUDIO" (PDF).

Playing Back Pictures on a TV Screen

Preparations: Turn this unit and the TV off.

1 Connect the camera and the TV with an HDMI micro cable.

- Check the direction of the terminals and plug in/out straight holding onto the plug. (It may result in malfunction by the deforming of the terminal if it is plugged in obliquely or in wrong direction.)

Do not connect devices to incorrect terminals. Doing so may cause malfunction.

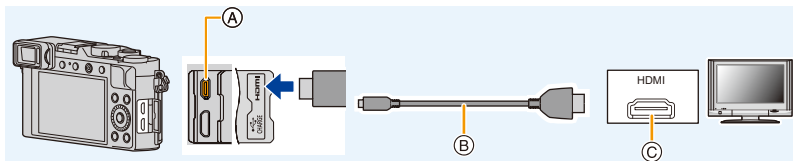

(A) [HDMI] socket

(B) HDMI micro cable

(C) HDMI socket (on the TV)

- Use a "High Speed HDMI micro cable" with the HDMI logo. Cables that do not comply with the HDMI standards will not work. "High Speed HDMI micro cable" (Type D–Type A plug, up to 2 m (6.6 feet) long)

2 Turn on the TV and select the input to match the connector in use.

3 Turn the camera on and then press [▶].

- Depending on the aspect ratio, black bars may be displayed on the top and bottom or the left and right of the images.
- Change the screen mode on your TV if the picture is displayed with the top or bottom cut off.
- Check the [HDMI Mode (Play)]. (P206)
- To play back 24p motion pictures, set [HDMI Mode (Play)] to [AUTO]. Otherwise, the picture is not output at 24 frames per second.
- No image will be displayed on the monitor/viewfinder of the camera. In addition, no audio will be output from the speaker of the camera.
- HDMI output will be cancelled if a USB connection cable (supplied) is connected simultaneously.
- Depending on the TV to be connected, 4K burst files may not be played back correctly.
- Read the operating instructions for the TV.

Using VIERA Link (HDMI)

What is the VIERA Link (HDMI) (HDAVI Control™)?

- This function allows you to use your remote control for the Panasonic TV for easy operations when this unit has been connected to a VIERA Link compatible device using an HDMI micro cable for automatic linked operations.
(Not all operations are possible.)
- VIERA Link is a unique Panasonic function built on an HDMI control function using the standard HDMI CEC (Consumer Electronics Control) specification.
Linked operations with HDMI CEC compatible devices made by other companies are not guaranteed. When using devices made by other companies that are compatible with VIERA Link, refer to the operating instructions for the respective devices.
- This unit supports “VIERA Link Ver.5” function. “VIERA Link Ver.5” is the standard for Panasonic’s VIERA Link compatible equipment. This standard is compatible with Panasonic’s conventional VIERA Link equipment.

Preparations:

MENU →  **[Setup]** → **[TV Connection]** → **[VIERA Link]** → **[ON]**

- 1 **Connect this unit to a Panasonic TV compatible with VIERA Link with an HDMI micro cable (P272).**
- 2 **Turn the camera on and then press .**
- 3 **Operate with the remote control for the TV.**

Turning this unit off:

If you use the remote control for the TV to turn the TV off, this unit is also turned off.

Automatic input switching:

- If you connect with an HDMI micro cable and then turn this unit on, and then press , the input channel on the TV automatically switches to this unit’s screen. If the TV’s power is in standby status, it will turn on automatically (if [Set] has been selected for the TV’s [Power on link] setting).
- Operation using the buttons on this unit will be limited.
- To play back the sound of a film during a slide show, set [Sound] to [AUTO] or [Audio] on the Slide Show setting screen.
- Use a “High Speed HDMI micro cable” with the HDMI logo.
Cables that do not comply with the HDMI standards will not work.
“High Speed HDMI micro cable” (Type D–Type A plug, up to 2 m (6.6 feet) long)
- Refer to [P299](#) if VIERA Link is not operating correctly.

Saving still pictures and motion pictures on your PC

You can acquire recorded pictures to a PC by connecting the camera and the PC.

- Some PCs can read directly from the card removed from the camera. For details, refer to the operating instructions of your PC.

■ PC that can be used

The unit can be connected to any PC capable of recognising a mass storage device.

- Windows support: Windows 10/Windows 8.1/Windows 8/Windows 7
- Mac support: OS X v10.5 to v10.11, macOS 10.12, macOS 10.13



AVCHD motion pictures may not be imported correctly when copied as files or folder

- When using Windows, import AVCHD motion pictures with “PHOTOfunSTUDIO”.
- When using Mac, you can copy motion pictures recorded in [AVCHD] using “iMovie”.
Note, however, that it may not be possible to copy pictures depending on the picture quality settings.

(For details about iMovie, please contact Apple Inc.)

Downloading software

- To download the software, you need to connect the PC to the Internet.
- It may take some time to download the software depending on the communication environment.
- Supported OSs are current as of September 2018 and are subject to change.

PHOTOfunSTUDIO 10.0 AE

This software allows you to manage images. For example, you can send pictures and motion pictures to a PC and sort them by recording date or model name. You can also perform operations such as writing images to a DVD, processing and correcting images, and editing motion pictures.

Check the site below to download and install the software.

Download the software while it is available for download.

- Download expiration: September 2023

http://panasonic.jp/support/global/cs/soft/download/d_pfs10ae.html

(This Site is English only.)

- Operating environment

OS	Windows® 10 (32bit/64bit), Windows® 8.1 (32bit/64bit), Windows® 7 (32bit/64bit) SP1 • For 4K motion pictures and 4K photos, a 64 bit OS version of Windows 10/Windows 8.1/Windows 7 is required.
CPU	Pentium® 4 (2.8 GHz or higher)
Display	1024×768 pixels or more (1920×1080 pixels or more recommended)
RAM	1 GB or more (32bit), 2 GB or more (64bit)
Free hard disk space	450 MB or more for installing software

- Refer to the operating instructions for “PHOTOfunSTUDIO” (PDF file) for details about the operating environment required to use the playback and editing functions for 4K motion pictures and the picture cropping function for 4K photos.
- “PHOTOfunSTUDIO” is not compatible with Mac.

SILKYPIX Developer Studio SE

This software processes and edits RAW files.

Edited images can be saved in a format (JPEG, TIFF, etc.) that can be displayed on a personal computer.

Check the site below to download and install the software.

<http://www.isl.co.jp/SILKYPIX/english/p/>

• Operating environment

OS	Windows® 10, Windows® 8.1, Windows® 8, Windows® 7
	Mac OS X v10.6 to v10.11, macOS 10.12, macOS 10.13

- For details on how to use the “SILKYPIX Developer Studio”, refer to the Help or the Ichikawa Soft Laboratory’s support website.

LoiLoScope 30 day full trial version

(Windows 10 / 8.1 / 8 / 7)

This software allows you to edit motion pictures with ease.

Check the site below to download and install the software.

<http://loilo.tv/product/20>

- For more information about the operating environment of and how to use LoiLoScope, download the LoiLoScope manual available for download at the website.
- “LoiLoScope” is not compatible with Mac.

Transferring images to a PC

Preparations:

Install "PHOTOfunSTUDIO" to the PC. (P275)

1 Connect the computer and camera with the USB connection cable (supplied).

- Please turn on this unit and your PC before connecting.
- Check the direction of the terminals and plug in/out straight holding onto the plug. (It may result in malfunction by the deforming of the terminal if it is plugged in obliquely or in wrong direction.)
Do not connect devices to incorrect terminals. Doing so may cause malfunction.
- Do not use any other USB connection cables except the supplied one.
- A message about charging may be displayed. Wait until the display disappears.

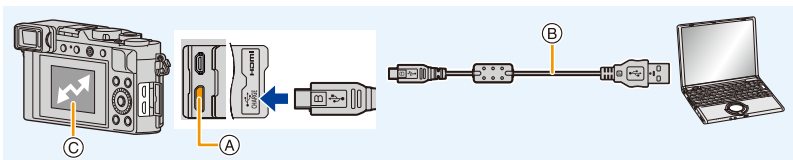

- (A) [USB/CHARGE] socket
- (B) USB connection cable (supplied)
- (C) Communicating

• Do not disconnect the USB connection cable (supplied) while this is displayed.

2 Press ▲/▼ to select [PC(Storage)], and then press [MENU/SET].

- If [USB Mode] is set to [PC(Storage)] in the [Setup] menu in advance, the camera will be automatically connected to the PC without displaying the [USB Mode] selection screen.

3 Copy the images to a PC using "PHOTOfunSTUDIO".

- Do not delete or move copied files or folders in Windows Explorer.

When viewing in "PHOTOfunSTUDIO", you will not be able to play back or edit.

- Before removing or inserting the card, turn off the camera and disconnect the USB connection cable. Otherwise, damage may be caused to the recorded data.
- Use a sufficiently charged battery, or the AC adaptor (optional) and the DC coupler (optional).
- If the remaining battery power becomes low while the camera and the PC are communicating, the alarm beeps.

Disconnect the USB connection cable safely. Otherwise, data may be destroyed.

■ Copying to a PC without using “PHOTOfunSTUDIO” (For Mac)

You can drag and drop the folders and files containing the images you want to transfer into separate folders on your PC to save them.

• The content (folder structure) on the card of this unit is as follows.

For Windows: A drive ([LUMIX]) is displayed in [Computer]

For Mac: A drive ([LUMIX]) is displayed on the desktop

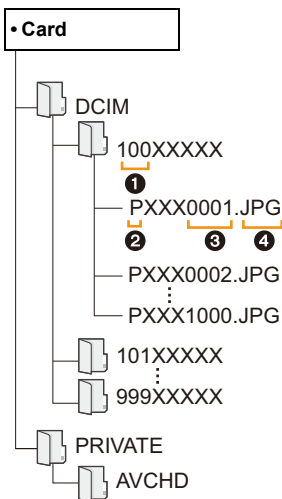

DCIM: Still/motion pictures

- ❶ Folder number
- ❷ Colour space P: sRGB
_: AdobeRGB

❸ File number

- ❹ JPG: Still pictures
- RW2: Pictures in RAW files
- MP4: [MP4] Motion pictures
4K burst file

AVCHD: Motion pictures in AVCHD

Saving still pictures and motion pictures on a Recorder

You can connect the camera to a Panasonic Blu-ray disc or DVD recorder and store pictures and motion pictures on it.

1 Connect the recorder and camera with the USB connection cable (supplied).

- Before connecting, turn on the camera and the recorder.
- Check the direction of the terminals and plug in/out straight holding onto the plug. (It may result in malfunction by the deforming of the terminal if it is plugged in obliquely or in wrong direction.)
Do not connect devices to incorrect terminals. Doing so may cause malfunction.
- Do not use any other USB connection cables except the supplied one.
- A message about charging may be displayed. Wait until the display disappears.

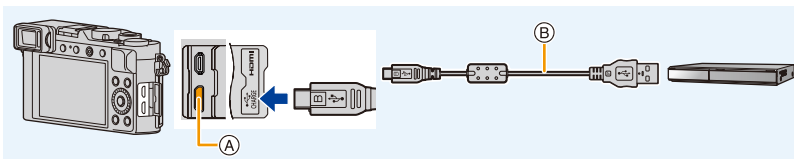

- (A) [USB/CHARGE] socket
(B) USB connection cable (supplied)

2 Press **▲/▼** to select [**PC(Storage)**], and then press [**MENU/SET**].

- If you set the [USB Mode] to [PC(Storage)] in the [Setup] menu, the [USB Mode] selection screen will not be displayed and the camera will automatically connect to the recorder.

3 Operate the recorder to copy.

- See the operating instructions for the recorder about the details about copying and playing back.
 - Modes such as 4K motion picture may not be supported depending on the recorder being used.
- Use a sufficiently charged battery or an AC adaptor (optional) and DC coupler (optional). If the remaining battery power becomes low while the camera and the recorder are communicating, the alarm beeps. In that case, cancel copying immediately. Otherwise, damage may be caused to the data.
- Before removing or inserting the card, turn off the camera and disconnect the USB connection cable. Otherwise, damage may be caused to the recorded data.

Printing the Pictures

You can directly connect the camera to a PictBridge-supported printer for printing.

Preparations:

- Perform the print quality and other settings at the printer before printing the pictures.
- Turn on the camera and the printer.

1 Connect the printer and camera with the USB connection cable (supplied).

- Check the direction of the terminals and plug in/out straight holding onto the plug. (It may result in malfunction by the deforming of the terminal if it is plugged in obliquely or in wrong direction.)
Do not connect devices to incorrect terminals. Doing so may cause malfunction.
- Do not use any other USB connection cables except the supplied one.
- A message about charging may be displayed. Wait until the display disappears.

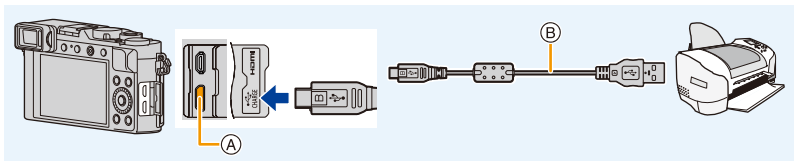

(A) [USB/CHARGE] socket

(B) USB connection cable (supplied)

- Do not disconnect the USB connection cable while [⊘] (Cable disconnect prohibit icon) is displayed.

(May not be displayed depending on the type of printer used.)

2 Press ▲/▼ to select [PictBridge(PTP)], and then press [MENU/SET].

3 Press ◀/▶ to select the picture and then press [MENU/SET].

4 Press ▲/▼ to select [Print start] and then press [MENU/SET].

Selecting multiple pictures and printing them

- 1 Press **▲** to select the multiple printing setting in step 3 of “Printing the Pictures” (P280).
- 2 Press **▲/▼** to select an item and then press **[MENU/SET]**.

[Multi Select]	Multiple pictures are printed at one time. <ul style="list-style-type: none"> • Press ▲/▼/◀/▶ to select the pictures and then press [MENU/SET]. (Press [MENU/SET] again to cancel the setting.) • After the pictures have been selected, press [DISP.].
[Select All]	Prints all the stored pictures.
[Rating]	Prints all images with [Rating] levels between [★1] and [★5].

- 3 Press **▲/▼** to select **[Print start]** and then press **[MENU/SET]**.

- Group pictures will not be displayed as group pictures but as single pictures.
- Disconnect the USB connection cable after printing.
- Use a sufficiently charged battery or an AC adaptor (optional) and DC coupler (optional). If the remaining battery power becomes low while the camera and the printer are connected, the alarm beeps. If this happens during printing, stop printing at once. If not printing, disconnect the USB connection cable.
- Before removing or inserting the card, turn off the camera and disconnect the USB connection cable. Otherwise, damage may be caused to the recorded data.
- Some printers can print directly from the card removed from the camera. For details, refer to the operating instructions of your printer.
- The camera is receiving an error message from the printer when the **[●]** indication lights yellow during printing. After finishing printing, make sure there are no problems with the printer.
- If the number of prints is high, the pictures may be printed several times. In this case, the remaining number of prints indicated may differ from the number set.
- Only pictures taken in JPEG format can be printed. Those taken in RAW will use the JPEG pictures that were simultaneously created. If an equivalent JPEG picture is not available, no print will take place.



Not available in these cases:

- Motion pictures, 4K burst files, and images recorded with the Post Focus function cannot be printed.

■ Making print settings on the camera

Setting options include the number of printed pictures and their size. Make settings before selecting [Print start].

[Print with Date]	[ON]/[OFF]
[Num.of prints]	Sets number of pictures (up to 999 pictures).
[Paper Size]	Sets the paper size.
[Page Layout]	Sets whether or not to add borders and how many pictures to be printed on each sheet of paper.

- If the printer does not support date printing, the date cannot be printed on the picture.
- Depending on the printer, the date print settings of the printer may take precedence so check if this is the case.
- Items not supported by the printer are not displayed.
- When you want to print pictures on a paper size or a layout which is not supported by the camera, set [Paper Size] or [Page Layout] to [] and then set the paper size or the layout on the printer.
(For details, refer to the operating instructions of the printer.)

Adding date and text to pictures

You can use [Text Stamp] in the [Playback] menu to stamp date and time on pictures.

■ Printing date without using [Text Stamp]

In-store printing:

Only recording date can be printed. Order date printing at a store.

The characters entered using the following menus cannot be printed at a store.

- [Age] and [Name] in [Face Recog.] or [Profile Setup]
- [Location] in [Travel Date]
- [Title Edit]

Printing at home:

When using a printer that supports date printing, you can print recording date and time by setting [Print with Date] to [ON].

You can use the software "PHOTOfunSTUDIO" to set the print settings for recording date and text information.

13. Others

Optional accessories

AC adaptor (optional)/DC coupler (optional)

By using the AC adaptor (optional) and DC coupler (optional), you can record and play back without worrying about the remaining battery charge.

The optional DC coupler can only be used with the designated Panasonic AC adaptor (optional).

- Always use a genuine Panasonic AC adaptor (optional).
- When using an AC adaptor (optional), use the AC cable supplied with the AC adaptor.
- Also read the operating instructions for the AC adaptor (optional) and DC coupler.

Monitor Display/Viewfinder Display

Display example: When [] (monitor style) is set and the monitor display is in use

- The information displayed, such as histograms, magnifications, and numeric values, are only for the purpose of reference.

In recording

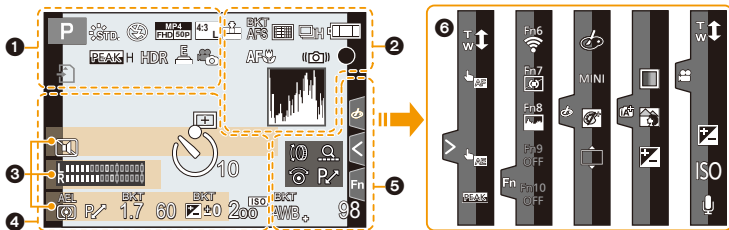





























1

	Recording Mode (P38, 39)
	Motion picture recording mode (P38)
	Custom settings (P71)
	Panorama Shot Mode (P118)
	Photo Style (P174)
	Flash Mode (P150)
	Flash (P151, 153)
	Recording format/Recording quality (P158)
	Aspect Ratio/Picture size (P172)
	Picture size (Panorama Shot Mode) (P118)
	Image effect (filter) adjustment display (P127)

EXPS	Image effect (filter) setting (P123)
	Card (displayed only during recording) (P28)
8m30s	Elapsed recording time*1 (P156)
	Simultaneous recording indicator (P161)
LVF/MON AUTO	Automatic viewfinder/monitor switching (P35)
PEAK H PEAK L	Peaking (P193)
	Highlight Shadow (P177)
HDR	HDR (P182)/iHDR (P60)
	Multi exposure (P183)
	Electronic shutter (P181)
	Picture-taking during motion picture recording (Photo Priority) (P161)
	Overheat indicator (P292)















2

 RAW	Quality (P173)
AFS AFF AFC MF	Focus Mode (P75, 88)
 AFS	Focus Bracket (P133)
  	AF Mode (P76)
	Face Recognition (P197)
AFL	AF Lock (P90)
   	Burst (P99)
	4K Photo (P101)
	Post Focus (P111)
  	Self-timer (P116)
  	Panorama Direction (P118)
	Battery indication (P22)
AF 	Macro recording (P87)
	Image Stabiliser (P140)
	Jitter alert (P140)
	Focus (Lights green.) (P37)/ Recording state (Flashes red.) (P156)
 LOW	Focus (Under low illumination) (P73)
 STAR	Focus (Starlight AF) (P73)
	Connected to Wi-Fi
	Connected to Bluetooth (P232)
GPS	Location Logging (P245)
	Histogram (P193)





3

Name ^{*2} (P199)
Number of days that have passed since the departure date ^{*3} (P201)
Age ^{*2} (P199)
Location ^{*3} (P201)
Current date and time/Travel destination setting ^{*3} :  (P201)
Exposure metre (P195)
Zoom (P142)





















4

	AF area (P82)
+	Spot metering target (P176)
+	Centre marker display (P194)
  	Self-timer (P116)
	Recording level display (P162)
	Silent Mode (P180)
AEL	AE Lock (P90)
  	Metering Mode (P45, 176)
	Programme Shift (P62)
1.7	Aperture value (P37)
 1.7	Aperture Bracket (P132)
60	Shutter speed (P37)
	Exposure compensation value (P91)
	Exposure Bracket (P132)
	Brightness (P61)
	Manual Exposure Assistance (P68)
200 ^{ISO}	ISO sensitivity (P93)

5

	Dial Guide (P191)
	White Balance Bracket (P133) White Balance Fine Adjustment (P97)
	White Balance (P95)
	Colour (P61)
98	Number of recordable pictures (P29)
r20	Maximum number of pictures that can be taken continuously (P100)
R 8m30s	Available recording time*1 (P30)

6

Touch tab (P190)	
	 Touch zoom (P146)
	 Touch Shutter (P44)
	 Touch AF (P44)
	 Touch AE (P45)
	 Peaking (P193)
	 Function button (P50)
   (P157)	 Colour (P61)
	 Defocus control function (P61)
	 Brightness (P61, 157)
	 Type of defocus ([Miniature Effect]) (P126)
	 One point colour (P126)
	 Position of the light source (P127)
	 Image effect (filter) adjustment (P129)
	 Image effect ON/OFF (P129)
	MINI Image effect (filter) (P129)
	ISO ISO sensitivity (P157)
	 Sound recording level adjustment (P157)

*1 m: minute, s: second

*2 This is displayed for about 5 seconds when the camera is turned on if the [Profile Setup] setting is set.

*3 This is displayed for about 5 seconds when the camera is turned on, after setting the clock and after switching from Playback Mode to Recording Mode.

On-monitor recording information

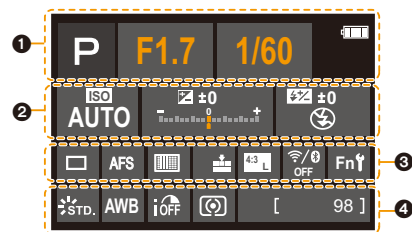

1		Recording Mode (P38)
		Motion picture recording mode (P38)
		Panorama Shot Mode (P118)
	F1.7	Aperture value (P37)
	1/60	Shutter speed (P37)
	TIME	Time recording (P69)
		Battery indication (P22)
		Card (displayed only during recording)
2	ISO AUTO	ISO sensitivity (P93)
		Exposure compensation value (P91)
		Brightness (P61)
		Manual Exposure Assistance (P68)
		Flash Mode (P150)
		Flash (P151, 153)

3		Single (P98)
		Burst (P99)
		4K Photo (P101)
		Post Focus (P111)
		Self-timer (P116)
		Panorama Direction (P120)
	AFS AFF AFC MF	Focus Mode (P75, 88)
		AF Mode (P76)
		Quality (P173)
		Aspect Ratio/Picture size (P172)
		Wi-Fi/Bluetooth (P227)
	Fn	Function button setting (P50)
4		Photo Style (P174)
	AWB AWBc	White Balance (P95)
		Intelligent Dynamic Range Control (P178)
		Metering Mode (P45, 176)
	98	Number of recordable pictures (P29)
	r20	Maximum number of pictures that can be taken continuously (P100)
	R8m30s	Available recording time* (P30)
	----	No card

* m: minute, s: second

In playback

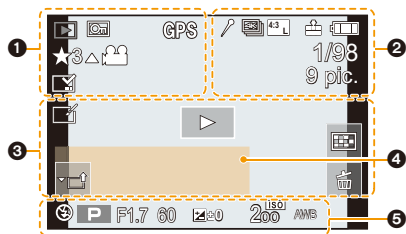

	Playback Mode (P212)
	Protected picture (P213)
GPS	Location Logging (P245)
★ 3	Rating (P213)
	Cable disconnect prohibit icon (P280)
	Motion picture playback (P164)
	Save pictures from the 4K burst file (P106)
	Create pictures from an image recorded with the Post Focus function (P113)
	Play panorama (P121)
	Continuous group picture playback (P169)
	Focus Bracket (P133, 168)
	Stamped with text indication (P221)
8m30s	Elapsed playback time*1 (P164)
2	
	Icon indicating the presence of a marker (P107)
	4K Photo (4K burst file) (P101)
	Post Focus (P111)
	Focus Stacking (P114)
	Aspect Ratio/Picture size (P172)
	Recording format/Recording quality (P158)

	RAW	Quality (P173)
	Battery indication	(P22)
1/98	Picture number/Total pictures	
	Connected to Wi-Fi	
9 pic.	Number of group pictures	
8m30s	Motion picture recording time*1	(P164)

3		
	Clear Retouch completed icon (P220)	
	Currently retrieving information icon	
	Playback (Motion Pictures) (P164)	
	Upload (Wi-Fi) (P258)	
	Group Display (P169)	
	Sub Menu (P258)	
	Silent Mode (P180)	
1ST DAY	Number of days that have passed since the departure date (P201)	
	Multi Playback (P167)	
	Delete (P170)	

4		
Name*2	(P197, 199)	
Location*2	(P201)	
Title*2	(P214)	
Age	(P197, 199)	

5		
Recording information		

*1 m: minute, s: second

*2 It is displayed in order of [Title], [Location], [Name] ([Baby1]/[Baby2], [Pet]), [Name] ([Face Recog.]).

In playback

Detailed information display

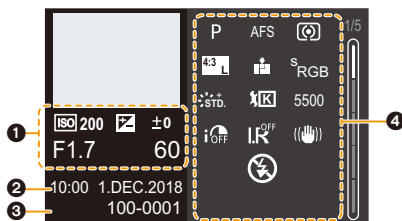

Histogram display

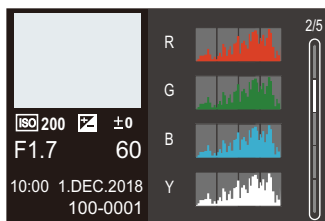
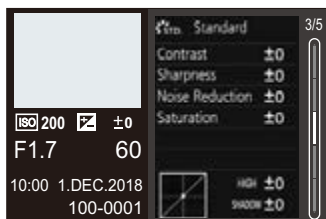
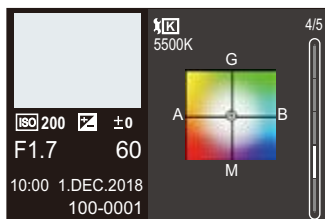

Photo style, Highlight shadow display



White balance display



Lens information display

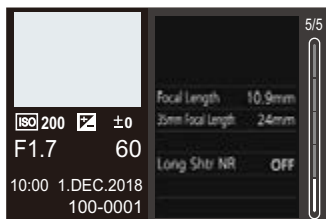

1

Recording information (basic)

2

Recorded date and time/World Time (P200)

3

100-0001 Folder/File number (P278)

4

Recording information (advanced)

5500 White Balance (Colour Temperature) (P96)

iOFF Intelligent Dynamic Range Control (P178)

HDR ON HDR (P182)/iHDR (P60)

iR OFF Intelligent Resolution (P178)

Message Display

The following explains the meaning of major messages displayed on the screen, and how to respond to them.

■ Memory cards

[Memory Card Error]/[Format this card?]

- Insert a different card.
- Perform formatting (P28) on this unit after saving necessary data on a PC, etc.

[Read Error]/[Write Error]/[Please check the card]

- It has failed to read or write data.
Remove the card after turning this unit off. Insert the card again, turn this unit on, and try to read or write the data again.
- Check whether card has been inserted correctly. (P26)
- Insert a different card.

[Recording was cancelled due to the limitation of the writing speed of the card]

- Motion picture recording and recording with the 4K Photo and Post Focus functions require the use of cards with Speed Class ratings that support the corresponding types of recording. Use supported cards. (P27)
- If recording stops even when you are using a card that meets the Speed Class rating, the data writing speed is too slow. We recommend making a backup and then formatting the card (P28).
Depending on the type of the card, recording may stop in the middle.

[Memory Card Error]/[This memory card cannot be used]

- Use a card compatible with this unit. (P27)

■ Battery

[This battery cannot be used]

- Use a genuine Panasonic battery. If this message is displayed even when a genuine Panasonic battery is used, contact the dealer or Panasonic.
- Remove any dirt and dust on the battery terminal.

■ Wi-Fi function

[Failed to connect wireless access point]/[Connection failed]/[No destination found]

- The wireless access point information set on this unit is wrong.
Check the authentication type, encryption type, and encryption key. (P265)
- It may not be possible to connect to a wireless access point depending on the radio wave condition of other devices. Check the status of other devices that are connected to the wireless access point and devices that use the 2.4 GHz frequency.

[Connection failed. Please retry in a few minutes.]/[Network disconnected. Transfer stopped.]

- Radio waves from the wireless access point are getting weak.
Perform the connection closer to the wireless access point.
- Depending on the wireless access point, connection may be automatically disconnected after specific time has passed.
Reconnect the connection again.

[Connection failed]

- Change the access point to connect to in the smartphone Wi-Fi settings to this camera.

■ Others

[Some pictures cannot be deleted]/[This picture cannot be deleted]

- This feature can only be used with pictures that comply with the DCF standard (P163).
Perform formatting (P28) on this unit after saving necessary data on a PC, etc.

[Cannot be set on this picture]

- Images that do not comply with the DCF standard (P163) cannot be edited on the camera.

[A folder cannot be created]

- A folder cannot be created because there are no remaining folder numbers that can be used.
Perform formatting (P28) on this unit after saving necessary data on a PC, etc.
If you execute [No.Reset] in the [Setup] menu after formatting, the folder number is reset to 100. (P208)

[Please turn camera off and then on again]/[Lens not detected. Please turn camera on again.]/[System Error]

- Turn the camera off and on. If the message is still displayed even after repeating this a few times, contact the dealer where you purchased the camera.

Troubleshooting

First, try out the following procedures (P292 to P300).

If the problem is not resolved, it may be improved by selecting [Reset] (P208) on the [Setup] menu.

Recording stops before finishing. Cannot record. Cannot use some functions.

- When the ambient temperature is high or a motion picture is recorded continuously, the camera's temperature will rise. In that case, the camera may display [△] and then stop the recording or temporarily disable the functions below. Wait until the camera cools down.
 - [4K PHOTO]
 - [Post Focus]
 - [Motion Picture]

Battery and power source

The charging lamp blinks.

- Charging is being performed in a place with extremely high or low temperature.
 - Reconnect the USB connection cable (supplied) and retry charging in a place where ambient temperature is 10 °C to 30 °C (50 °F to 86 °F) (temperature conditions also apply to the battery itself).
- Charging is not possible if the power supply capacity of the computer is low.

Camera does not work even if the camera is turned on.

Camera switches off as soon as the camera is turned on.

- The battery is exhausted. Charge the battery. (P19)

This unit is turned off automatically.

- [Economy] is enabled. (P203)

The battery becomes flat too quickly.

- When [Pre-Burst] ([4K Pre-Burst]) is set for recording, the battery drains faster.
 - Use these functions only when recording with them.
- Is a Wi-Fi connection being used for a long period of time?

The battery can become flat quickly when connected to Wi-Fi.

 - Turn the camera off frequently by using the [Economy] etc. (P203)

Recording

Flicker or horizontal stripes may appear under lighting such as a fluorescent or LED lighting fixture.

- This is characteristic of MOS sensors which serve as the camera's pickup sensors.
This is not a malfunction.
- When using the electronic shutter (P181), lowering the shutter speed may reduce the effect of the horizontal stripes.
- If noticeable flicker or horizontal stripes appear under lighting such as a fluorescent or LED lighting fixture during motion picture recording, manually adjust the shutter speed to 1/60 or 1/100. Setting a fixed shutter speed can reduce the flicker or horizontal stripes.



Taking pictures is not possible.

The shutter will not operate immediately when the shutter button is pressed.

- Is [Focus/Release Priority] in the [Custom] menu set to [FOCUS]? (P188)
You cannot take a picture until the subject is brought into focus.

The recorded picture is whitish.

- Lens is dirty (fingerprints, etc.).
→ Turn the camera on to extract lens barrel, and clean lens surface with a soft, dry cloth.

The recorded picture is too bright or dark.

- Is the AE Lock (P90) applied incorrectly?

Multiple pictures are taken at one time.

- Drive mode is set to other than [Single]. (P98)
- Are you using the bracket function? (P130)

The subject is not focused properly.

- The subject is beyond the focus range of the camera.
- Is [Shutter AF] in the [Custom] menu set to [OFF]? (P186)
- Is [Focus/Release Priority] in the [Custom] menu set to [RELEASE]? (P188)
- Is the AF Lock (P90) applied incorrectly?
- If there are fingerprints or dirt on the lens, the focus may be set to the lens and not the subject.

The recorded picture is blurred.

The Image Stabiliser is not effective.

- The shutter speed will become slower and the Image Stabiliser function may not work properly when taking pictures especially in dark places.
→ We recommend using a tripod and the self-timer when taking pictures with a slow shutter speed.

**The recorded picture looks rough.
Noise appears on the picture.**

- Decrease the ISO sensitivity. (P93)
- Increase the setting for [Noise Reduction] in [Photo Style] or lower the setting for each of the items other than [Noise Reduction]. (P175)
- Set the [Long Shtr NR] to [ON]. (P179)

The subject appears distorted on the picture.

- During recording with the electronic shutter, motion picture recording and 4K photo recording, if you take a picture of a moving subject, it may appear distorted on the picture. This is characteristic of MOS sensors which serve as the camera's pickup sensors. This is not a malfunction.

The brightness or the hue of the recorded picture is different from the actual scene.

- When recording under fluorescent or LED lighting fixture, etc., increasing the shutter speed may introduce slight changes to brightness and colour. These are a result of the characteristics of the light source and do not indicate a malfunction.
- When recording subjects in extremely bright locations or recording under fluorescent lighting, LED lighting fixture, mercury lamp, sodium lighting, etc., the colours and screen brightness may change or horizontal striping may appear on the screen.

Motion pictures

Recording motion pictures is not possible.

- You may not be able to record for a short while after turning this unit on when using a large capacity card.

Motion picture recording stops in the middle.

- Motion picture recording requires cards with Speed Class ratings that support particular types of recording. Use supported cards. (P27)

Sometimes focus adjustment with Auto Focus mode is difficult while recording 4K motion pictures.

- This may occur when taking a picture by reducing the Auto Focus speed in order to adjust the focus at high precision. This is not a malfunction.

In motion pictures, abnormal clicking and buzzing sounds are recorded. The recorded sound is very quiet.

- With recording in a quiet environment, the sound of aperture and focus may be recorded in motion pictures. This is not a malfunction. The focus operation during recording of motion pictures can be set to [OFF] in [Continuous AF] (P160).
- While recording motion pictures, plugging the aperture of the microphone with a finger may reduce the level of audio recording or audio may not record at all. Also be careful because the operation sound of lenses can easily be recorded at this time.

Operating sounds are recorded in a motion picture.

- If the operating sounds made during recording bother you, we recommend changing the relevant setting through touch operations. (P157)
- Since motion pictures are recorded until the motion picture button is pressed to stop recording, noticeable operating sounds may be heard when they are played back. To suppress this sound, we recommend trying the following method.
 - Divide the end part of a motion picture using [Video Divide] (P224) in the [Playback] menu. In some cases, motion pictures cannot be divided at a position close to the end part of the motion picture. To avoid this problem, continue recording for an extra 3 seconds.

Flash

The flash is not activated.

- The flash becomes unavailable in the following case.
 - Flash set to [☹]. (P147, 148, 150)
- When the electronic shutter is used, the flash is not activated. (P181)
- When [Silent Mode] is set to [ON], the flash is not activated. (P180)

Monitor/Viewfinder

The Monitor/Viewfinder turns off although the camera is turned on.

- If no operations are performed during the set time period, [Auto LVF/Monitor Off] (P203) is activated, and the Monitor/Viewfinder turns off.
- When an object or your hand is positioned near the eye sensor, the Monitor display may switch to the Viewfinder display.

It may flicker for an instant or the brightness of the screen may change significantly for an instant.

- This occurs due to the aperture of the lens changing when the shutter button is pressed halfway, or when the brightness of the subject changes. This is not a malfunction.

Monitor and viewfinder do not switch when [LVF] is pressed.



- It is only displayed on the monitor when the camera is connected to a PC or printer.

Playback

The picture is not played back. There are no recorded pictures.

- Is the card inserted in the camera?
- Is this a folder or picture which was processed in the PC?
If it is, it cannot be played back by this unit.
→ It is recommended to use the software "PHOTOfunSTUDIO" to write pictures from PC to card.
- Set [Playback Mode] to [Normal Play]. (P212)

Red part of the recorded image has changed colour to black.

- When Red-Eye Removal ([] or []) is performed, red parts may be corrected to black.
→ We recommend recording images with Flash Mode set to [] or [Red-Eye Removal] set to [OFF]. (P178)

Wi-Fi function

**A Wi-Fi connection cannot be established.
Radio waves get disconnected.
Wireless access point is not displayed.**

■ General tips for using a Wi-Fi connection

- Use within the communication range of the device to be connected.
- Is any device, such as microwave oven, cordless phone, etc., that uses 2.4 GHz frequency operated nearby?
 - Radio waves may get interrupted when used simultaneously. Use them sufficiently away from the device.
- When the battery indicator is flashing red, the connection with other equipment may not start or the connection may be disrupted.
(A message such as [Communication error] is displayed.)
- If you place the camera on a metal table or shelf, the radio waves may be adversely affected. In such cases, you may not be able to establish a connection. Move the camera away from the metal surface.

■ About a wireless access point

- Check if the wireless access point to connect is in operating state.
- Check the radio wave condition of the wireless access point.
 - Perform the connection closer to the wireless access point.
 - Change the location and orientation of the wireless access point.
- It may not display even if the radio waves exist depending on the setting of the wireless access point.
 - Turn off and on the wireless access point.
 - If the wireless channel of the wireless access point cannot be set automatically, set it manually by selecting from channel 1 to 11.
 - When the network SSID of the wireless access point is set not to broadcast, the wireless access point may not be detected. Enter the network SSID to start the connection (P265) or enable the SSID broadcast of the wireless access point.

This unit is not displayed in the Wi-Fi setting screen of the smartphone.

- From the Wi-Fi setting menu on the smartphone, turn off and then on the Wi-Fi function.

When I try to set up a Wi-Fi connection with a PC, my user name and password are not recognised, so I cannot connect to the PC.

- Some OS versions use two types of accounts: a local account and a Microsoft account. Be sure to use the user name and password for the local account.

The PC is not recognised when I use a Wi-Fi connection. The camera cannot be connected to PC via Wi-Fi connection.

- The default workgroup name is set to "WORKGROUP". If you changed the workgroup name, the PC will not be recognised.
In [PC Connection] of the [Wi-Fi Setup] menu, change the workgroup name to that of the PC you are connecting to. (P269)
- Please confirm login name and password are correctly typed.
- When the system time of Mac computer or Windows PC connected to a camera differs severely from that of the camera, the camera cannot be connected to the computer or PC in some OSs.
→ Please confirm [Clock Set] and [World Time] of the camera matches with time, date and time zone in Windows PC or Mac computer. When both settings do not match severely, please match them.

Images cannot be transmitted to the web service.

- Confirm that the login information (login ID/user name/email address/password) is correct.

It takes time to transmit an image to the web service.**Transmission of the image fails midway. Some images cannot be transmitted.**

- Is the size of the image too large?
→ Transmit after dividing the motion picture with [Video Divide] (P224).
→ Reduce the image size at [Size] (P250), and then send.
- It may take longer time to transmit when distance to the wireless access point is far.
→ Transmit closer to the wireless access point.
- File format of the motion picture that can be sent differs depending on the destination. (P248)

I have forgotten the password for the Wi-Fi.

- Execute the [Reset Network Settings] in the [Setup] menu. (P209)
However, the information you have set on the [Wi-Fi Setup] or [Bluetooth] will be reset.

TV, PC and printer

No image on the TV. The TV screen is blurred or not coloured.

- Is the camera connected to the TV correctly? (P272)
→ Set the input selector of the TV to HDMI.

VIERA Link does not work.

- Is the [VIERA Link] on this unit set to [ON]? (P206)
→ Check the VIERA Link setting on the connected device.
→ Turn this unit off and on.

Cannot communicate with the PC.

- Set to [PC(Storage)] in [USB Mode]. (P205, 277)
- Turn this unit off and on.

The card is not recognised by the PC. (SDXC memory card is used.)

- Check if your PC is compatible with SDXC memory cards.
- A message prompting to format the card may be displayed when connecting, but do not format.
- If the [Access] displayed on the monitor does not disappear, disconnect the USB connection cable after turning this unit off.

The picture cannot be printed when the camera is connected to a printer.

- Pictures cannot be printed using a printer that does not support PictBridge.
- Set to [PictBridge(PTP)] in [USB Mode]. (P205, 280)

The ends of the pictures are cut at printing.

- Release any trimming or edgeless printing settings on printer before printing.
- The aspect ratio of pictures is different from that of paper used for printing.
→ If printing in shop, check if 16:9 sizes can be printed.

Others

There is a sound from lens unit.

- It is a sound of lens movement or aperture operation when this unit is turned on or off. This is not a malfunction.
- This is the sound of automatic aperture adjustment, which occurs when a zoom operation, etc, causes the brightness to change. It is not a malfunction.

Zooming stops instantaneously.

- When using the Extra optical zoom, the zooming action will stop temporarily. This is not a malfunction.

A red lamp sometimes turns on when the shutter button is pressed halfway.

- In dark places, the AF Assist Lamp (P187) lights red to make it easier to focus on a subject.

The camera becomes warm.

- It may become somewhat warm during use, but this does not affect performance or quality.

The clock is reset.

- If you do not use the camera for a long time, the clock may be reset.
→ Reset the clock. (P32)

When using zoom, picture becomes slightly warped and the edges of the subject become coloured.

- Pictures may be slightly warped or coloured around the edges, depending on the zoom ratio, but this is not a fault.



MENU



Cautions for Use

Optimal use of the camera

Keep this unit as far away as possible from electromagnetic equipment (such as microwave ovens, TVs, video games etc.).

- If you use this unit on top of or near a TV, the pictures and/or sound on this unit may be disrupted by electromagnetic wave radiation.
- Do not use this unit near cell phones because doing so may result in noise adversely affecting the pictures and/or sound.
- Recorded data may be damaged, or pictures may be distorted, by strong magnetic fields created by speakers or large motors.
- Electromagnetic wave radiation may adversely affect this unit, disturbing the pictures and/or sound.
- If this unit is adversely affected by electromagnetic equipment and stops functioning properly, turn this unit off and remove the battery or disconnect AC adaptor. Then reinsert the battery or reconnect AC adaptor and turn this unit on.

Do not use this unit near radio transmitters or high-voltage lines.

- If you record near radio transmitters or high-voltage lines, the recorded pictures and/or sound may be adversely affected.

Always use the supplied cords and cables.

If you use optional accessories, use the cords and the cables supplied with them.

Do not extend the cords or the cables.

Do not keep objects that may be influenced magnetically close to the speaker.

- Magnetised objects such as bank cards, commuter passes, watches, may be adversely affected by the magnetic influence of the speaker.

Do not spray the camera with insecticides or volatile chemicals.

- If the camera is sprayed with such chemicals, the body of the camera may be damaged and the surface finish may peel off.

Cleaning

Before cleaning the camera, remove the battery or the DC coupler (optional), or disconnect the power plug from the outlet. Then wipe the camera with a dry, soft cloth.

- When the camera is soiled badly, it can be cleaned by wiping the dirt off with a wrung wet cloth, and then with a dry cloth.
- Do not use solvents such as benzine, thinner, alcohol, kitchen detergents, etc., to clean the camera, since it may deteriorate the external case or the coating may peel off.
- When using a chemical cloth, be sure to follow the accompanying instructions.

When not using the camera for a long period of time

- Always remove the battery and the card from the camera.
- If the battery is left inserted in the camera, it will discharge even if the camera is turned off. If the battery continues to be left in the camera, it will discharge excessively and may become unusable even if charged.
- Do not keep rubber or plastic products in contact with the camera for a long period of time.
- We recommend storing the camera with a desiccant (silica gel) when you keep it in a closet or a cabinet.
- Store the battery in a cool and dry place with a relatively stable temperature: (Recommended temperature: 15 °C to 25 °C (59 °F to 77 °F), Recommended humidity: 40%RH to 60%RH)
- When storing the battery for a long period of time, we recommend charging it once a year. Remove the battery from the camera and store it again after it has completely discharged.
- Check all the parts before taking pictures when you have not used the camera for a long period of time.

About the Monitor/Viewfinder

- Do not press the monitor with excessive force. Uneven colours may appear on the monitor and it may malfunction.
- If the camera is cold when you turn it on, the picture on the Monitor/Viewfinder will be slightly darker than usual at first. However, the picture will return to normal brightness when the internal temperature of the camera increases.

Extremely high precision technology is employed to produce the Monitor/Viewfinder screen. However there may be some dark or bright spots (red, blue or green) on the screen. This is not a malfunction. Though the Monitor/Viewfinder screen parts are produced with highly controlled precision technology, some pixels may be inactive or always lit. The spots will not be recorded on pictures on a card.

About the Lens

- Do not press the lens with excessive force.
- Images may appear slightly white if lens is dirty (fingerprints, etc.). Turn the camera on, hold the extracted lens barrel with your fingers, and gently wipe the lens surface with a soft, dry cloth.
- Do not leave the camera with the lens facing the sun as rays of light from the sun may cause it to malfunction. Also, be careful when placing the camera outside or near a window.

Battery

The battery is a rechargeable lithium ion battery. Its ability to generate power comes from the chemical reaction that takes place inside it. This reaction is susceptible to the surrounding temperature and humidity. If the temperature is too high or too low, the operating time of the battery will become shorter.

Always remove the battery after use.

- Place the removed battery in a plastic bag, and store or keep away from metallic objects (clips, etc.).

Bring charged spare batteries when going out.

- Be aware that the operating time of the battery becomes shorter in low temperature conditions such as at a ski resort.
- When you travel, do not forget to bring the AC adaptor (supplied) and the USB connection cable (supplied) so that you can charge the battery in the country that you are travelling in.

If you drop the battery accidentally, check to see if the body of the battery and the terminals are damaged.

- Inserting a damaged battery in the camera will damage the camera.

Dispose of unusable battery.

- The battery has a limited life.
- Do not throw the battery into fire because it may cause an explosion.

Do not allow battery terminals to come into contact with metal objects (such as necklaces, hairpins, etc.).

- This can cause short-circuiting or heat generation and you may be badly burned if you touch a battery.

AC adaptor (supplied)

- If you use the AC adaptor (supplied) near a radio, the radio reception may be disturbed. Keep the AC adaptor (supplied) 1 m (3.3 feet) or further away from radios.
- The AC adaptor (supplied) may generate whirring sounds when it is being used. This is not a malfunction.
- After use, be sure to disconnect the power supply device from the electrical outlet. (A very small amount of current is consumed if it is left connected.)

Card and data

Do not leave the card where the temperature is high, where electromagnetic waves or static electricity are easily generated or exposed to direct sunlight.

Do not bend or drop the card.

- The card may be damaged or the recorded content may be damaged or deleted.
- Put the card in the card case or the storage bag after use and when storing or carrying the card.
- Do not allow dirt, dust, or water to get into the terminals on the back of the card and do not touch the terminals with your fingers.
- Recorded data may be damaged or lost if the camera breaks down due to inappropriate handling. Panasonic will not be liable for any damage caused due to loss of recorded data.

■ Notice for when transferring to another party, or disposing of the memory card

- **Format or delete using the camera or a PC will only modify the file management information, it will not erase the data in the memory card completely.**
- **It is recommended to physically destroy the memory card or use the commercially available computer data deletion software to completely erase the data in the memory card before transferring to another party or disposing.**
- **Management of data in the memory card is the responsibility of the user.**

About tripods or unipods

- When you use a tripod, make sure the tripod is stable when this unit is attached to it.
- You may not be able to remove the card or the battery when using a tripod or unipod.
- Make sure that the screw on the tripod or unipod is not at an angle when attaching or detaching the camera. You may damage the screw on the camera if you use excessive force when turning it. Also, the camera body and the rating label may be damaged or scratched if the camera is attached too tightly to the tripod or unipod.
- Read the operating instructions for the tripod or unipod.

About the personal information

We recommend that you enable [Wi-Fi Password] and [Wi-Fi Function Lock] to protect personal information. (P269, 270)

If a name or birthday is set for [Profile Setup]/Face Recognition function, this personal information is kept in the camera and recorded in the image.

Be sure to pay special attention to the privacy, likeness rights, etc. of a subject and take your own responsibility when you use the [Silent Mode], or use functions such as writing the location information and changing the shutter noise, etc.

Disclaimer

- Information including personal information may be altered or vanish due to erroneous operation, effect of static electricity, accident, malfunction, repair, or other handlings. Please note in advance that Panasonic is not liable in any way for any direct or indirect damage from the alteration or vanishing of information or personal information.

When requesting a repair, transferring to another party, or disposing.

- After making a copy of personal information, always delete information such as personal information and wireless LAN connection settings that you have saved within the camera with [Reset Network Settings]/[Delete account] (P209, 262).
- Reset the settings to protect the personal information. (P208)
- Remove the memory card from the camera when requesting a repair.
- Settings may return to factory default when camera is repaired.
- Please contact the dealer where you purchased the camera or Panasonic if above operations are not possible due to malfunction.

When transferring to another party, or disposing of the memory card, please refer to “Notice for when transferring to another party, or disposing of the memory card”. (P304)

When uploading images on web services

- Images may contain information that can be used for identifying individuals such as titles, recording dates, and location information. When uploading images on web services, check carefully, and then upload.

Wi-Fi function

■ Use the camera as a wireless LAN device

When using equipment or computer systems that require more reliable security than wireless LAN devices, ensure that the appropriate measures are taken for safety designs and defects for the systems used. Panasonic will not take any responsibility for any damage that arises when using the camera for any purpose other than as a wireless LAN device.

■ Use of the Wi-Fi function of this camera is presumed to be in countries where this camera is sold

There is the risk that the camera violates the radio wave regulations if used in countries other than those where this camera is sold, and Panasonic takes no responsibility for any violations.

■ There is the risk that data sent and received via radio waves may be intercepted

Please note that there is the risk that data sent and received via radio waves may be intercepted by a third party. We strongly recommend that you set an encryption to maintain information security.

■ Do not use the camera in areas with magnetic fields, static electricity or interference

- Do not use the camera in areas with magnetic fields, static electricity or interference, such as near microwave ovens. These may cause the interruption of the radio waves.
- Using the camera near devices such as microwave ovens or cordless telephones that use the 2.4 GHz radio wave band may cause a decrease in performance in both devices.

■ Do not connect to the wireless network you are not authorised to use

When the camera utilises its Wi-Fi function, wireless networks will be searched automatically. When this happens, wireless networks that you are not authorised to use (SSID*) may be displayed, however do not attempt to connect to the network as it may be considered as unauthorised access.

- * SSID refers to the name that is used to identify a network over a wireless LAN connection. If the SSID matches for both devices, transmission is possible.

- SDXC Logo is a trademark of SD-3C, LLC.
- The terms HDMI and HDMI High-Definition Multimedia Interface, and the HDMI Logo are trademarks or registered trademarks of HDMI Licensing Administrator, Inc. in the United States and other countries.
- “AVCHD”, “AVCHD Progressive” and the “AVCHD Progressive” logo are trademarks of Panasonic Corporation and Sony Corporation.
- Dolby, Dolby Audio, and the double-D symbol are trademarks of Dolby Laboratories.
- HDAVI Control™ is a trademark of Panasonic Corporation.
- Adobe is a trademark or registered trademark of Adobe Systems Incorporated in the United States and/or other countries.
- Pentium is a trademark of Intel Corporation in the U.S. and/or other countries.
- Windows is a registered trademark or trademark of Microsoft Corporation in the United States and/or other countries.
- iMovie, Mac, OS X and macOS are trademarks of Apple Inc., registered in the U.S. and other countries.
- iPad, iPhone, iPod, and iPod touch are trademarks of Apple Inc., registered in the U.S. and other countries.
- App Store is a service mark of Apple Inc.
- Android and Google Play are trademarks or registered trademarks of Google Inc.



MENU



- The Bluetooth® word mark and logos are registered trademarks owned by the Bluetooth SIG, Inc. and any use of such marks by Panasonic Corporation is under license. Other trademarks and trade names are those of their respective owners.
- The Wi-Fi CERTIFIED™ Logo is a certification mark of Wi-Fi Alliance®.
- The Wi-Fi Protected Setup™ Logo is a certification mark of Wi-Fi Alliance®.
- “Wi-Fi®” is a registered trademarks of Wi-Fi Alliance®.
- “Wi-Fi Protected Setup™”, “WPA™”, and “WPA2™” are trademarks of Wi-Fi Alliance®.
- DLNA, the DLNA Logo and DLNA CERTIFIED are trademarks, service marks, or certification marks of the Digital Living Network Alliance.
- This product uses “DynaFont” from DynaComware Corporation. DynaFont is a registered trademark of DynaComware Taiwan Inc.
- QR Code is a registered trademark of DENSO WAVE INCORPORATED.
- Other names of systems and products mentioned in these instructions are usually the registered trademarks or trademarks of the manufacturers who developed the system or product concerned.



This product is licensed under the AVC Patent Portfolio License for the personal use of a consumer or other uses in which it does not receive remuneration to (i) encode video in compliance with the AVC Standard (“AVC Video”) and/or (ii) decode AVC Video that was encoded by a consumer engaged in a personal activity and/or was obtained from a video provider licensed to provide AVC Video. No license is granted or shall be implied for any other use. Additional information may be obtained from MPEG LA, L.L.C.

See <http://www.mpegla.com>