

# Panasonic®

## Basic Operating Instructions

Digital Camera/  
Lens Kit/Body

Model No. **DC-G9L**  
**DC-G9**



# LUMIX

Please read these instructions carefully before using this product, and save this manual for future use.

**More detailed operating instructions are available in “Operating Instructions for advanced features (PDF format)”. To read it, download it from the website. (P121)**

DVQX1336ZA

F1117HN0

## Dear Customer,

We would like to take this opportunity to thank you for purchasing this Panasonic Digital Camera. Please read these Operating Instructions carefully and keep them handy for future reference. Please note that the actual controls and components, menu items, etc. of your Digital Camera may look somewhat different from those shown in the illustrations in these Operating Instructions.

### Carefully observe copyright laws.

- Recording of pre-recorded tapes or discs or other published or broadcast material for purposes other than your own private use may infringe copyright laws. Even for the purpose of private use, recording of certain material may be restricted.

## Information for Your Safety

### WARNING:

To reduce the risk of fire, electric shock or product damage,

- Do not expose this unit to rain, moisture, dripping or splashing.
- Use the recommended accessories.
- Do not remove covers.
- Do not repair this unit by yourself. Refer servicing to qualified service personnel.

The socket outlet shall be installed near the equipment and shall be easily accessible.

### ■ Product identification marking

Product	Location
Digital camera	Bottom
Battery charger	Bottom

### ■ About the battery pack

#### CAUTION

- Danger of explosion if battery is incorrectly replaced. Replace only with the type recommended by the manufacturer.
- When disposing of the batteries, please contact your local authorities or dealer and ask for the correct method of disposal.
- Do not heat or expose to flame.
- Do not leave the battery(ies) in a car exposed to direct sunlight for a long period of time with doors and windows closed.

#### Warning

Risk of fire, explosion and burns. Do not disassemble, heat above 60 °C or incinerate.

## ■ About the AC adaptor (supplied)

### **CAUTION!**

**To reduce the risk of fire, electric shock or product damage,**

- **Do not install or place this unit in a bookcase, built-in cabinet or in another confined space. Ensure this unit is well ventilated.**

- The AC adaptor is in the standby condition when the mains plug is connected. The primary circuit is always "live" as long as the mains plug is connected to an electrical outlet.

## Cautions for Use

- Use a "High Speed HDMI cable" with the HDMI logo.  
Cables that do not comply with the HDMI standards will not work.  
"High Speed HDMI cable" (Type A–Type A plug, up to 1.5 m (4.9 feet) long)
- Always use a genuine Panasonic shutter remote control (DMW-RSL1: optional).
- Do not use the headphone cables with the length of 3 m (9.8 feet) or more.
- Do not use the synchro cables with the length of 3 m (9.8 feet) or more.
- Do not use the stereo microphone cables with the length of 3 m (9.8 feet) or more.

**Keep this unit as far away as possible from electromagnetic equipment (such as microwave ovens, TVs, video games etc.).**

- If you use this unit on top of or near a TV, the pictures and/or sound on this unit may be disrupted by electromagnetic wave radiation.
- Do not use this unit near cell phones because doing so may result in noise adversely affecting the pictures and/or sound.
- Recorded data may be damaged, or pictures may be distorted, by strong magnetic fields created by speakers or large motors.
- Electromagnetic wave radiation may adversely affect this unit, disturbing the pictures and/or sound.
- If this unit is adversely affected by electromagnetic equipment and stops functioning properly, turn this unit off and remove the battery or disconnect AC adaptor. Then reinsert the battery or reconnect AC adaptor and turn this unit on.

**Do not use this unit near radio transmitters or high-voltage lines.**

- If you record near radio transmitters or high-voltage lines, the recorded pictures and/or sound may be adversely affected.

**• Before cleaning the camera, remove the battery or the DC coupler (DMW-DCC12: optional), or disconnect the power plug from the outlet.**

- **Do not press the monitor with excessive force.**
- **Do not press the lens with excessive force.**
- **Do not spray the camera with insecticides or volatile chemicals.**
- **Do not keep rubber or plastic products in contact with the camera for a long period of time.**
- **Do not use solvents such as benzine, thinner, alcohol, kitchen detergents, etc., to clean the camera, since it may deteriorate the external case or the coating may peel off.**
- **Do not leave the camera with the lens facing the sun, as rays of light from the sun may cause it to malfunction.**

- 
- **Always use the supplied cords and cables.**
  - **Do not extend the cords or the cables.**
  - **During access (image writing, reading and deleting, formatting etc.), do not turn this unit off, remove the battery, card or disconnect the AC adaptor. Furthermore, do not subject the camera to vibration, impact or static electricity.**
  - The data on the card may be damaged or lost due to electromagnetic waves, static electricity or breakdown of the camera or the card. We recommend storing important data on a PC etc.
  - Do not format the card on your PC or other equipment. Format it on the camera only to ensure proper operation.
- 

- **The battery is not charged when the camera is shipped. Charge the battery before use.**
  - **The battery is a rechargeable lithium ion battery. If the temperature is too high or too low, the operating time of the battery will become shorter.**
  - The battery becomes warm after using and during and after charging. The camera also becomes warm during use. This is not a malfunction.
  - **Do not leave any metal items (such as clips) near the contact areas of the power plug or near the batteries.**
  - Store the battery in a cool and dry place with a relatively stable temperature: (Recommended temperature: 15 °C to 25 °C (59 °F to 77 °F), Recommended humidity: 40%RH to 60%RH)
  - **Do not store the battery for a long time while fully charged.** When storing the battery for a long period of time, we recommend charging it once a year. Remove the battery from the camera and store it again after it has completely discharged.
- 

**-If you see this symbol-**



**Disposal of Old Equipment and Batteries  
Only for European Union and countries with recycle systems**

These symbols are only valid in the European Union and countries with recycle systems.

If you wish to discard this product, please contact your local authorities or dealer and ask for the correct method of disposal.

# Contents

Information for Your Safety.....	2
----------------------------------	---

## Preparation/Basic

Care of the camera .....	6
Standard Accessories .....	7
About cards that can be used with this unit .....	8
About the Lens .....	9
Names and Functions of Components .....	10
Quick Start Guide .....	13
Basic Operations .....	21
Setting menu items .....	28
Calling frequently-used menus instantly (Quick Menu).....	29
Assigning Frequently-Used Functions to Buttons/Lever (Function Buttons/Function Lever) .....	30

## Recording

Taking Pictures using the Automatic Function (Intelligent Auto Mode).....	33
Setting the Focus Mode (AFS/AFF/AFC).....	35
Setting the Auto Focus Mode .....	36
Specifying the AF area position.....	39
Adjusting Focus Manually .....	41
Fixing the Focus and the Exposure (AF/AE Lock).....	42
Compensating the Exposure .....	42
Setting the Light Sensitivity .....	43
Adjusting the White Balance .....	44
Select a Drive Mode .....	46
Taking Pictures using Burst Mode .....	47
Recording 6K/4K Photos .....	48
Controlling Focus After Recording (Post Focus/Focus Stacking) .....	52
Taking Pictures with Time Lapse Shot/ Stop Motion Animation .....	54
Taking Pictures While Adjusting a Setting Automatically (Bracket Recording).....	56
Image Stabiliser.....	59
Raising the telescopic effect .....	61

Taking Pictures with the External Flash (Optional).....	62
Recording Motion Picture .....	63
Recording Motion Pictures in Creative Video Mode .....	66

## Playback

Playing Back Pictures .....	69
Playing Back Motion Pictures .....	69
Switching the Playback Method.....	70
Playing Back Group Pictures .....	71
Deleting Pictures .....	72

## Menu

Menu list .....	73
-----------------	----

## Wi-Fi/Bluetooth

What you can do with the Wi-Fi®/Bluetooth® function .....	88
Connecting to a smartphone/tablet.....	90
Controlling with a Smartphone/Tablet.....	94
Setting up a connection to a PC via a wireless access point.....	98

## Others

Playing Back Pictures on a TV Screen ...	100
Saving still pictures and motion pictures on your PC.....	100
Controlling the Camera from a PC .....	103
Monitor Display/Viewfinder Display .....	104
Status LCD Indications .....	108
Message Display .....	109
Troubleshooting .....	110
Specifications.....	114
Digital Camera Accessory System .....	120
Reading the Operating Instructions (PDF format).....	121
Limited Warranty (ONLY FOR AUSTRALIA) .....	122

## Care of the camera

### **Do not subject to strong vibration, shock, or pressure.**

- The lens, monitor, or external case may be damaged if used in the following conditions. It may also malfunction or image may not be recorded if you:
  - Drop or hit the camera.
  - Press hard on the lens or the monitor.

### **■ Splash Proof**

Splash Proof is a term used to describe an extra level of protection this camera offers against exposure to a minimal amount of moisture, water or dust. Splash Proof does not guarantee that damage will not occur if this camera is subjected to direct contact with water.

In order to minimise the possibility of damage please be sure the following precautions are taken:

- The Splash Proof feature works in conjunction with the lenses that were specifically designed to support this feature.
- The camera is not designed to be dust and splash proof when the USB connection cable is connected.
- Make sure that all doors, socket caps and terminal covers are securely closed.
- Make sure that you are in a dry and secure place when changing the battery, lens or memory card. After changing, make sure their protective doors are securely closed.
- If this camera is exposed to water, sand or any other foreign material clean it as soon as possible, taking the necessary precautions that the foreign substance does not get inside the camera.

If sand, dust, or liquids such as water droplets adhere to the monitor, wipe them off with a dry soft cloth.

- Not doing so may cause the monitor to respond incorrectly to touch operations.
- If the monitor is closed when such liquids are present, malfunction may result.

### **When using in cold temperatures (–10 °C to 0 °C (14 °F to 32 °F)):**

- Attach a Panasonic interchangeable lens with a minimum recommended operating temperature of –10 °C (14 °F) before use.

**Do not place your hands inside the mount of the digital camera body. Since the sensor unit is a precision apparatus, it may cause a malfunction or damage.**

**If you shake the camera while it is turned off, its sensors may move or a rattling sound may be heard. The sound is caused by the In-Body Image Stabiliser, and this is not a malfunction.**

### **■ About Condensation (When the lens, the viewfinder or monitor is fogged up)**

- Condensation occurs when the ambient temperature or humidity changes. Be careful of condensation since it causes lens, viewfinder and monitor stains, fungus and camera malfunction.
- If condensation occurs, turn the camera off and leave it for about 2 hours. The fog will disappear naturally when the temperature of the camera becomes close to the ambient temperature.

# Standard Accessories



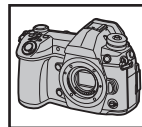

Check that all the accessories are supplied before using the camera.  
Product numbers correct as of November 2017. These may be subject to change.











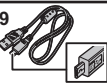

Digital Camera Body

(This is referred to as **camera body** in these operating instructions.)

1	Interchangeable Lens <sup>*1,2</sup>
2	Lens Hood
3	Lens Cap <sup>*3</sup>
4	Lens Rear Cap <sup>*3</sup>
5	Body Cap <sup>*4</sup>
6	Battery Pack (Indicated as <b>battery pack</b> or <b>battery</b> in the text) Charge the battery before use.
7	Battery Charger <sup>*5</sup> (Indicated as <b>battery charger</b> or <b>charger</b> in the text)
8	AC Adaptor (Indicated as <b>AC adaptor (supplied)</b> in the text) This is used for charging and power supply.
9	USB Connection Cable (for exclusive use with the Battery Charger) (Indicated as <b>USB connection cable (for charger)</b> in the text)
10	USB Connection Cable
11	Shoulder Strap
12	Hot shoe cover <sup>*4</sup> (P62)
13	Eye Cup <sup>*4</sup>
14	Flash synchro socket cap <sup>*4</sup>
15	Cover for the battery grip connector <sup>*4</sup>

DC-G9L			
1	 H-ES12060	3	 SYF0083
2	 1ZE4Z260Z	4	 VFC4605

5	 VKF4971	9	 K1HY04YY0106	13	 DVYE1062Y/K
6	 DMW-BLF19E	10	 K2KYYY00245	14	 VKF5108
7	 DMW-BTC13 (A : DVLC1002Z)	11	 DVPW1005Z	15	 SKF0145K
8	 VSK0815M	12	 SKF0106K		

\*1 This is referred to as **lens** in these operating instructions.

\*2 The interchangeable lens (H-ES12060) included in DC-G9L is dust- and splash-proof.

\*3 This is attached to the interchangeable lens at the time of purchase.

\*4 This is attached to the camera body at the time of purchase.

\*5 Order the part number (A) to purchase only a battery charger.



- SD Memory Card, SDHC Memory Card and SDXC Memory Card are indicated as **card** in the text.
- **The card is optional.**
- Description in these operating instructions is based on the interchangeable lens (H-ES12060).
- Consult the dealer or Panasonic if you lose the supplied accessories. (You can purchase the accessories separately.)

## About cards that can be used with this unit

<b>SD Memory Card</b> (512 MB to 2 GB)	<ul style="list-style-type: none"> <li>• This unit is compatible with UHS-I/UHS-II UHS Speed Class 3 standard SDHC/SDXC memory cards.</li> <li>• Operation of the cards on the left has been confirmed with Panasonic's cards.</li> </ul>
<b>SDHC Memory Card</b> (4 GB to 32 GB)	
<b>SDXC Memory Card</b> (48 GB to 128 GB)	

### ■ Recording of motion pictures/6K photos/4K photos and speed class ratings

Use a card that meets the following ratings of the SD Speed Class or UHS Speed Class.

[Rec Format]	[Rec Quality]	Speed class	Label example
[AVCHD]	All	Class 4 or higher	CLASS  
	FHD		
[MP4]	4K	UHS Speed Class 3	

<b>High Speed Video</b> <b>6K/4K Photo</b> <b>Post Focus function</b>	UHS Speed Class 3	
---	-------------------	---

- SD Speed Class and UHS Speed Class are the speed standards regarding continuous writing. To check the class, see the labelled side, etc. of the card.
- **Please confirm the latest information on the following website.**  
<http://panasonic.jp/support/global/cs/dsc/>  
(This Site is English only.)
- Keep the memory card out of reach of children to prevent swallowing.



## About the Lens

This unit can use the dedicated lenses compatible with the Micro Four Thirds™ System lens mount specification (Micro Four Thirds mount).

You can also use a lens of any of the following standards by attaching a mount adaptor.



Lens	Mount adaptor
Four Thirds™ mount specification lens 	Mount Adaptor (DMW-MA1: optional)
Leica M Mount interchangeable lens	M Mount Adaptor (DMW-MA2M: optional)
Leica R Mount interchangeable lens	R Mount Adaptor (DMW-MA3R: optional)

### About the firmware of your interchangeable lens

For smoother recording, we recommend updating the firmware of the interchangeable lens to the latest version.

- **To view the latest information on the firmware or to download the firmware, visit the support site below:**

<http://panasonic.jp/support/global/cs/dsc/>

(This Site is English only.)

- To check the firmware version of the interchangeable lens, attach it to the camera body and select [Version Disp.] in the [Setup] menu.

# Names and Functions of Components

## ■ Camera body

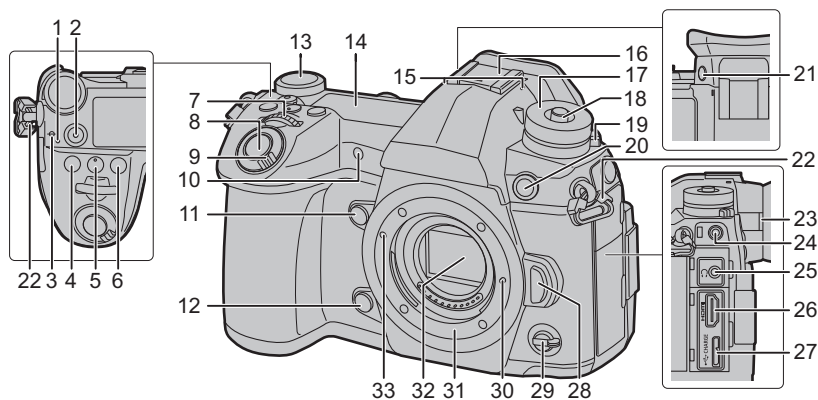

<b>1</b>	Charging lamp (P16)/ WIRELESS connection lamp (P88)	<b>16</b>	Hot shoe (Hot shoe cover) (P62) • Keep the hot shoe cover out of reach of children to prevent swallowing.
<b>2</b>	Motion picture button (P63)	<b>17</b>	Mode dial (P23)
<b>3</b>	Focus distance reference mark	<b>18</b>	Mode dial lock button (P23)
<b>4</b>	[] (Exposure Compensation) button (P42)	<b>19</b>	Drive mode dial (P46)
<b>5</b>	[ISO] (ISO sensitivity) button (P43)	<b>20</b>	Flash synchro socket (Flash synchro socket cap)
<b>6</b>	[WB] (White Balance) button (P44)	<b>21</b>	[V.MODE] button (P19)
<b>7</b>	Front dial (P21)	<b>22</b>	Shoulder strap eyelet (P13)
<b>8</b>	Shutter button (P20)	<b>23</b>	Diopter adjustment dial (P19)
<b>9</b>	Camera ON/OFF switch (P18)/ Status LCD backlight dial (P21)	<b>24</b>	[MIC] socket
<b>10</b>	Self-timer indicator/ AF Assist Lamp		Headphone socket
<b>11</b>	Function button (Fn4) (P30)	<b>25</b>	• Excessive sound pressure from earphones and headphones can cause hearing loss.
<b>12</b>	Preview button (P24)/Function button (Fn5) (P30)	<b>26</b>	[HDMI] socket (P100)
<b>13</b>	Rear dial (P21)	<b>27</b>	[USB/CHARGE] socket (P102)
<b>14</b>	Status LCD (P108)	<b>28</b>	Lens release button (P17)
<b>15</b>	Stereo microphone • Be careful not to cover the microphone with your finger. Doing so may make sound difficult to record.	<b>29</b>	Function lever (P22)
		<b>30</b>	Lens lock pin
		<b>31</b>	Mount
		<b>32</b>	Sensor
		<b>33</b>	Lens fitting mark (P17)

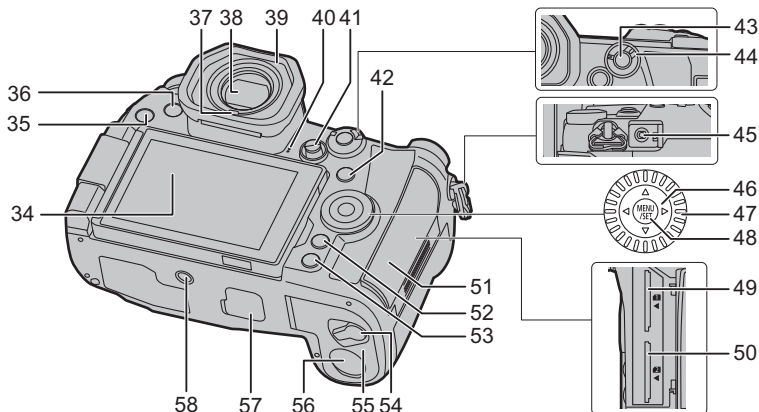

<b>34</b> Touch screen (P27)/monitor (P104)	<b>52</b> [Q.MENU] button (P29)/[Fn2] button (P30)/ [ ] (Delete) button (P72)/[ ] (Cancel) button (P29)
<b>35</b> [ ] (Playback) button (P69)	<b>53</b> [DISP.] button (P25)
<b>36</b> [LVF] button (P25)/[Fn3] button (P30)	<b>54</b> Release lever (P14)
<b>37</b> Eye sensor (P25)	<b>55</b> Battery door (P14)
<b>38</b> Viewfinder (P25)	<b>56</b> DC coupler cover (P120) • When using an AC adaptor, ensure that the Panasonic DC coupler (DMW-DCC12: optional) and AC adaptor (DMW-AC10G: optional) are used.
<b>39</b> Eye cup • Keep the eye cup out of reach of children to prevent swallowing.	<b>57</b> Cover for the battery grip connector • Keep the cover for the battery grip connector out of reach of children to prevent swallowing.
<b>40</b> Speaker	<b>58</b> Tripod mount • It may not be possible to attach and securely fasten a tripod with a screw length of 5.5 mm (0.22 inch) or more to the camera. Doing so may also damage the camera.
<b>41</b> Joystick (P22, 40)/Function button (P30) Centre (Fn11)/▲ (Fn12)/▶ (Fn13)/▼ (Fn14)/ ◀ (Fn15)	<b>Function buttons ([Fn6] to [Fn10]) are touch icons.</b> Touch the [ ] tab on the recording screen to display them.
<b>42</b> [ ] (Auto Focus Mode) button (P35)/ [Fn1] button (P30)	
<b>43</b> [AF/AE LOCK] button (P42)	
<b>44</b> Focus mode lever (P35, 41)	
<b>45</b> [REMOTE] socket	
<b>46</b> Cursor buttons (P21)/Function button (P30) ▲ (Fn16)/▶ (Fn17)/▼ (Fn18)/◀ (Fn19)	
<b>47</b> Control dial (P21)	
<b>48</b> [MENU/SET] button (P21, 28)	
<b>49</b> Card slot 1 (P17)	
<b>50</b> Card slot 2 (P17)	
<b>51</b> Card door (P17)	

## ■ Lens

### H-ES12060

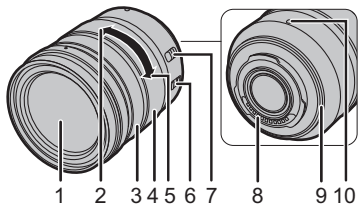

1	Lens surface
2	Tele
3	Focus ring (P41)
4	Zoom ring
5	Wide
6	O.I.S. switch
7	[AF/MF] switch • When either the [AF/MF] switch of the lens or the setting of the camera is set to [MF], Manual Focus (MF) is enabled.
8	Contact point
9	Lens mount rubber
10	Lens fitting mark (P17)

# Quick Start Guide

- Check that the camera is turned off.

## 1 Attaching the Shoulder Strap

- We recommend attaching the shoulder strap when using the camera to prevent it from dropping.

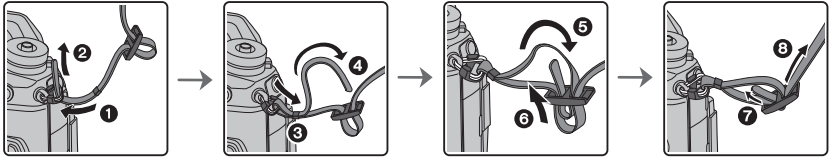

- Perform steps 1 to 8 and then attach the other side of the shoulder strap.
- Use the shoulder strap around your shoulder.
  - Do not wrap the strap around your neck. It may result in injury or accident.
- Do not leave the shoulder strap where an infant can reach it.
  - It may result in an accident by mistakenly wrapping around the neck.

## 2 Charging the Battery

The battery that can be used with this unit is DMW-BLF19E.

### ■ Charge the battery using the battery charger

- Use the charger, AC adaptor (supplied), USB connection cable (for charger), and battery that are designed for exclusive use with the camera.

- 1 Connect the battery charger and the AC adaptor (supplied) with the USB connection cable (for charger).
- 2 Insert the AC adaptor (supplied) into the power outlet.

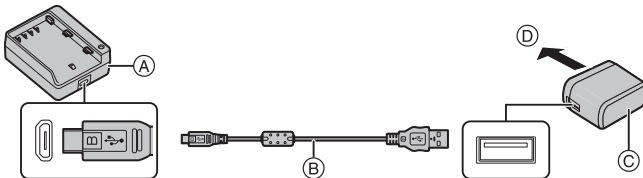

- (A) Charger (for exclusive use with the camera)      (C) AC adaptor (supplied)  
 (B) USB connection cable (for charger)      (D) To power outlet

### 3 Attach the battery paying attention to the direction of the battery.

- The [CHARGE] indicator (E) lights up and charging begins.
- Do not use any other USB connection cables except the supplied one.
- Do not use any other AC adaptors except the supplied one.

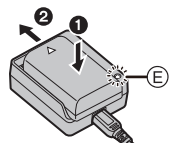

## ■ About the [CHARGE] indicator

**On:** Charging.

**Off:** Charging has completed.

(After charging is complete, disconnect the AC adaptor (supplied) from the power outlet and remove the battery.)

### • When the [CHARGE] indicator flashes

- The battery temperature is too high or too low. It is recommended to charge the battery again in an ambient temperature of between 10 °C and 30 °C (50 °F and 86 °F).
- The terminals of the charger or the battery are dirty. In this case, wipe them with a dry cloth.

## ■ Charging time

When the charger (supplied) is used

**Charging time**

**Approx. 190 min**

- The indicated charging time is for when the battery has been discharged completely. The charging time may vary depending on how the battery has been used. The charging time for the battery in hot/cold environments or a battery that has not been used for a long time may be longer than normal.

## ■ Inserting the Battery

- Always use genuine Panasonic batteries (DMW-BLF19E).
- If you use other batteries, we cannot guarantee the quality of this product.

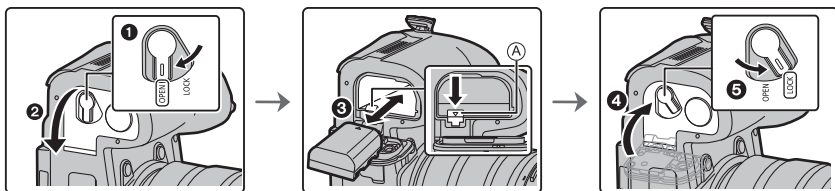

- Being careful about the battery orientation, insert all the way until you hear a locking sound and then check that it is locked by lever (A).  
When removing the battery, push the lever (A) toward the arrow and pull out the battery.

## ■ Charge the battery using the camera

- Use the dedicated AC adaptor (supplied), USB connection cable (supplied) and battery.

Camera conditions	Charge
Turned off	○
Turned on	—

**Insert the battery into this unit.  
Check that this unit is turned off.**

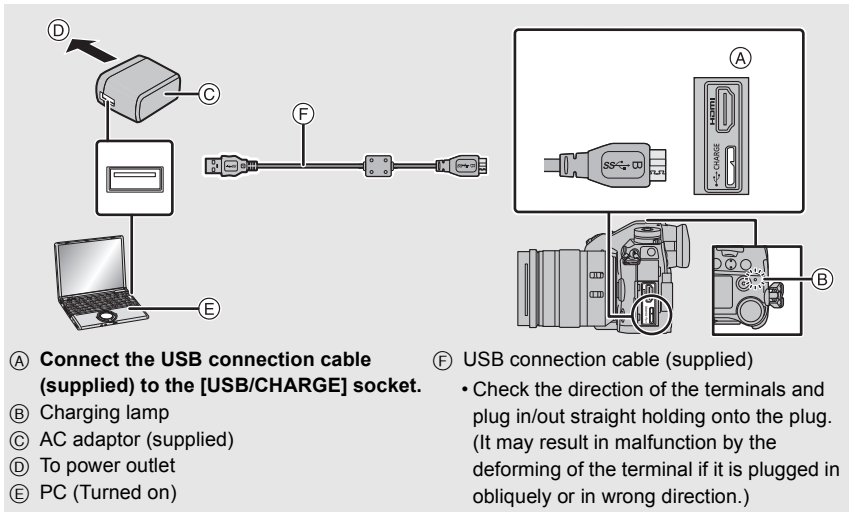

- Do not use any other USB connection cables except the supplied one.
- Do not use any other AC adaptors except the supplied one.
- The AC adaptor (supplied) and USB connection cable (supplied) are for this camera only. Do not use them with other devices.

### Charging from the power outlet

**Connect the AC adaptor (supplied) and this camera with the USB connection cable (supplied), and insert the AC adaptor (supplied) into the power outlet.**

- The camera consumes a small amount of power even after it is turned off by setting the camera on/off switch to [OFF]. When leaving the product unused for a long time, disconnect the AC adaptor (supplied) from the power outlet for power saving.

### Charging from a computer

**Connect the computer and this camera with the USB connection cable (supplied).**

### ■ About the charging lamp

**Lit red:** Charging.

**Off:** Charging has completed.

**(When charging is complete, disconnect the camera from the power outlet or computer.)**

#### • When the charging lamp flashes

- Reconnect the USB connection cable (supplied) in a location where the ambient temperature (and the temperature of battery) is in a 10 °C to 30 °C (50 °F to 86 °F) range, and try charging again.
- If your PC is not capable of supplying sufficient power, charging is not possible.

### ■ Charging time



When using the AC adaptor (supplied)

Charging time	Approx. 230 min
---------------	-----------------

- **The indicated charging time is for when the battery has been discharged completely. The charging time may vary depending on how the battery has been used. The charging time for the battery in hot/cold environments or a battery that has not been used for a long time may be longer than normal.**
- When power is supplied from a computer, the power supply capacity of the computer determines the charging time.

### ■ About the power supply

If you connect the camera to a power outlet or PC while the camera is turned on, power can be supplied via the USB connection cable (supplied).

- Insert the battery into the camera.
- [  ] is displayed on the recording screen while power is being supplied.
- **In certain situations where the camera is used, such as during recording, the battery may drain. The camera will turn off when the battery power runs out.**
- Power may not be supplied depending on the power supply capacity of the PC.
- Before connecting or disconnecting the AC adaptor (supplied), turn the camera off.
- If the ambient temperature is high or power is supplied continuously, after [  ] is displayed, the supply of power may stop. Wait until the camera cools down.



### 3 Inserting the Card (Optional)

- Check that the camera is turned off.

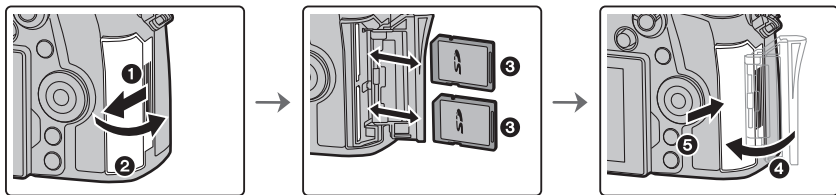

- Push it securely all the way until you hear a click while being careful about the direction in which you insert it.  
To remove the card, push the card until it clicks, then pull the card out upright.

#### ■ Card access indicators

##### Access indication

Lights up red while an image is being recorded to the card.

- **During access (image writing, reading and deleting, formatting etc.), do not turn this unit off, remove the battery, card or disconnect the AC adaptor. Furthermore, do not subject the camera to vibration, impact or static electricity.**

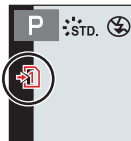

### 4 Attaching/Removing the Lens

- Change lenses where there is not a lot of dirt or dust.

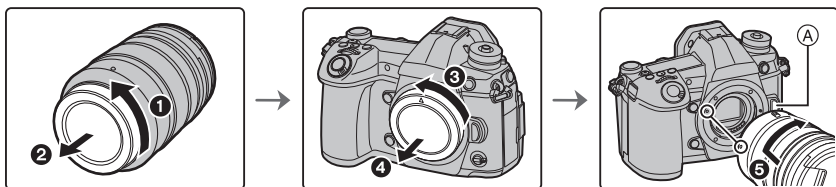

- Do not press the lens release button (A) when you attach a lens.

#### ■ Detaching the lens

- 1 Attach the lens cap.
- 2 While pressing on the lens release button (B), rotate the lens toward the arrow until it stops and then remove.

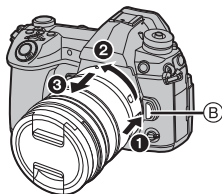

## 5 Opening the Monitor

At the time when this camera is purchased, the monitor is stowed in the camera body. Bring out the monitor as shown below.

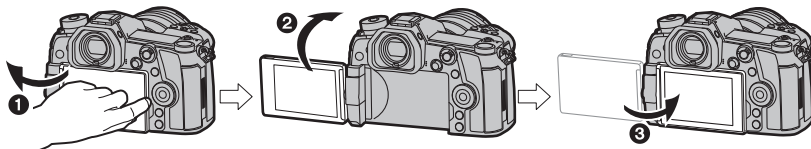

- ❶ Open the monitor. (Maximum 180°)
- ❷ It can be rotated 180° forward.
- ❸ Return the monitor to its original position.

- **When rotating the monitor, be careful not to apply too much force. Doing so may cause damage.**
- When not using the monitor it is recommended that you close it with the screen facing inward to prevent dirt and scratches.

## 6 Setting Date/Time (Clock Set)

- **The clock is not set when the camera is shipped.**

- 1 Turn the camera on.
- 2 Press [MENU/SET].
- 3 Press ◀/▶ to select the items (year, month, day, hour, minute), and press ▲/▼ to set.
- 4 Press [MENU/SET] to set.
- 5 When [The clock setting has been completed.] is displayed, press [MENU/SET].
- 6 When [Please set the home area] is displayed, press [MENU/SET].
- 7 Press ◀/▶ to select the home area, and then press [MENU/SET].

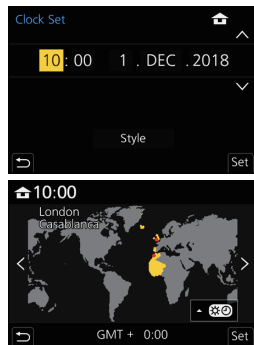
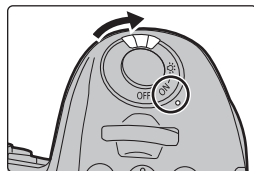

## 7 Diopter adjustment

### Rotate the diopter adjustment dial.

- Adjust until you can see the characters displayed in the viewfinder clearly.

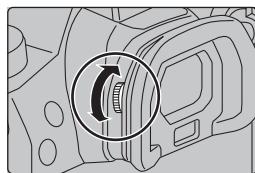

## 8 Formatting the card (initialisation)

Format the card before recording a picture with this unit.

**Since data cannot be recovered after formatting, make sure to back up necessary data in advance.**

**MENU** → **Setup** → **Format** → **[Slot 1]/[Slot 2]**

## 9 Set the mode dial to [P]

### Set the mode dial to [P].

- The dial is locked if the mode dial lock button is depressed. (A)  
Each press locks/unlocks the dial.

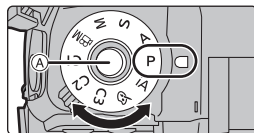

## 10 Taking pictures

- Hold the camera gently with both hands, keep your arms still at your side and stand with your feet slightly apart.**

- Do not cover the AF Assist lamp (A), or microphone (B) with your fingers or other objects.**
- Make sure your footing is stable and there is no danger of colliding with another person or object in the vicinity while taking pictures.

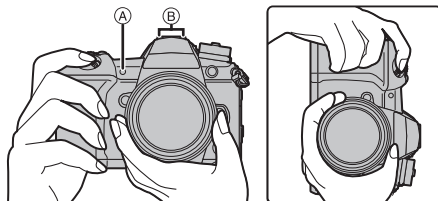

## 2 Press the shutter button halfway to focus.

- (A) Aperture value
- (B) Shutter speed
- (C) Focus indication

- Aperture value and shutter speed are displayed.

(It will flash in red if the correct exposure is not achieved, except when set to flash.)

- Once the subject is in focus, the focus indication is displayed. (When the subject is not in focus, the indication flashes.)

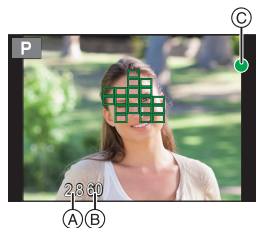
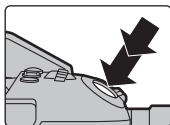
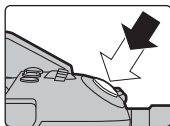

## 3 Press the shutter button fully (push it in further), and take the picture.

- Be careful not to move the camera when you press the shutter button.
- Pictures cannot be taken until focus is achieved when [Focus/Release Priority] is set to [FOCUS].

### ■ Free angle shooting

The monitor can be rotated to suit your needs. This is convenient as it allows you to take pictures from various angles by adjusting the monitor.

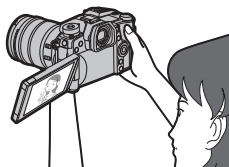

Taking pictures at a high angle

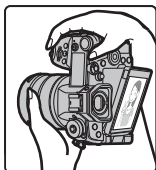

Taking pictures at a low angle

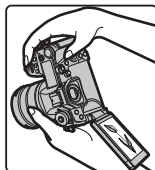

## 11 Check the picture you have taken

- To display the picture in Playback Mode, press [▶]. (P69)



# Basic Operations

## Turn on the status LCD backlight

Set the camera ON/OFF switch to [ON].

- When the camera ON/OFF switch is released, it returns to the [ON] position. The status LCD backlight turns off after approx. 5 seconds.
- To turn off the status LCD backlight immediately, set the camera ON/OFF switch to [OFF] again.
- If you start recording while the status LCD backlight is turned on, it will turn off.
- The status LCD backlight cannot be turned on when recording motion pictures or using [6K/4K Pre-Burst] or [Pre-Burst Recording] in [6K/4K PHOTO].

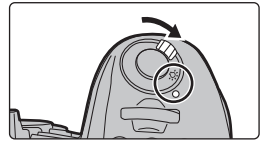

## Cursor buttons/[MENU/SET] button

Pressing the cursor button:

Selection of items or setting of values etc., is performed.

Pressing [MENU/SET]:

Confirmation of setting contents, etc., is performed.

- These operating instructions express the up, down, left, and right of the cursor button as ▲/▼/◀/▶.

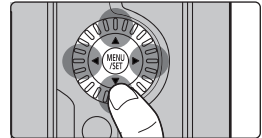

## Control Dial

Rotating:

Selection of items or setting of values etc., is performed.

- The operation of rotating the control dial is illustrated as below in these operating instructions.

Example: When rotating the control dial to the left or right: 

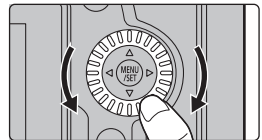

## Front Dial/Rear Dial



Rotating:

Selection of items or setting of values is performed during the various settings.

- These operating instructions describe operations of the front dial/rear dial as follows:

<p>e.g.: When rotating the front dial to the left or right</p>		<p>e.g.: When rotating the rear dial to the left or right</p>	
--	--	---	--

Allows you to set the aperture, shutter speed, and other settings when in **P / A / S / M** modes.

Mode dial	 Front dial	 Rear Dial
<b>P</b>	Programme Shift	Programme Shift
<b>A</b>	Aperture value	Aperture value
<b>S</b>	Shutter speed	Shutter speed
<b>M</b>	Aperture value	Shutter speed

## Joystick

The joystick can be operated in two ways: it can be moved up, down, left or right, or it can be pressed. The joystick provides the same functions as the cursor buttons/[MENU/SET] button.

### Moving:

**Selection of items or setting of values etc., is performed.**

### Pressing:

**Confirmation of setting contents, etc., is performed.**



Moving

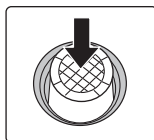

Pressing



- In these operating instructions, the up, down, left and right of the joystick are expressed as ▲/▼/◀/▶.

## Function lever

You can switch to the camera setting that enables the assigned function.

You can set the items to be assigned to the function lever in [Fn Lever Setting] in the [Custom] ([Operation]) menu. (P32)

### Change the function lever position.

	<b>MODE1</b>	The normal setting where the assigned function is disabled.
	<b>MODE2</b>	The setting where the assigned function is enabled.

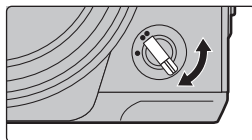

## Mode dial (Selecting a Recording Mode)



Press the mode dial lock button ❶ to release the lock.

- The dial is locked if the mode dial lock button is depressed. Each press locks/unlocks the dial.

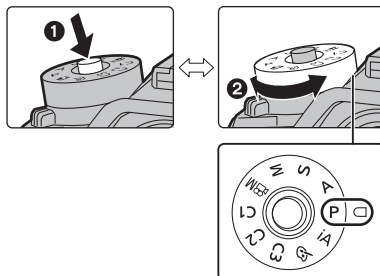
Rotate the mode dial ❷ and adjust the recording mode.



iA	Intelligent Auto Mode (P33)	
	Intelligent Auto Plus Mode (P33)	
P	<b>Programme AE Mode</b> Records at the aperture value and shutter speed set by the camera.	
	<p>■ Programme Shift</p> <p>❶ Press the shutter button halfway and display the aperture value and shutter speed value on the screen.</p> <p>❷ While the values are displayed (about 10 seconds), perform Programme Shift by rotating the rear dial or front dial.</p> <ul style="list-style-type: none"> <li>• To cancel Programme Shift, turn off this unit or rotate the front/rear dial until the Programme Shift indication disappears.</li> </ul>	
A	<p><b>Aperture-Priority AE Mode</b></p> <p>The shutter speed is automatically determined by the aperture value you set.</p> <p> : Aperture value (B)</p>	<p>• Rotate the front/rear dial to display the Exposure Meter (A). Unsuitable areas of the range are displayed in red.</p> <p>(Example: In Manual Exposure Mode)</p>
S	<p><b>Shutter-Priority AE Mode</b></p> <p>The aperture value is automatically determined by the shutter speed you set.</p> <p> : Shutter speed (C)</p>	
M	<p><b>Manual Exposure Mode</b></p> <p>The exposure is adjusted by the aperture value and the shutter speed which are manually adjusted.</p> <p> : Aperture value (B)</p> <p> : Shutter speed (C)</p>	
	<b>Creative Video Mode (P66)</b>	

C1	<p><b>Custom Mode</b> Use this mode to take pictures with previously registered settings.</p> <p>■ <b>Registering Personal Menu Settings (Registering custom settings)</b></p> <p>① Set in advance the Recording Mode you wish to save and select the desired menu settings on the camera.</p>
C2	<p>② Select the menu.</p> <p><b>MENU</b> →  <b>[Setup]</b> → <b>[Cust.Set Mem.]</b> → <b>Custom set where you want to register settings</b></p> <p>• You can register up to three custom sets to <b>C3</b> of the mode dial.</p>
C3	<p>■ <b>To change a custom set in [C3] ([Custom Mode] menu)</b></p> <p>① Set the mode dial to [<b>C3</b>].</p> <p>② Select the menu.</p> <p><b>MENU</b> → <b>C</b> [Custom Mode]</p> <p>③ Press <b>▲/▼</b> to select the custom setting you want to use, and then press <b>[MENU/SET]</b>.</p>
	<p><b>Creative Control Mode</b> This mode records with additional image effects.</p>

■ **Confirm the Effects of Aperture and Shutter Speed (Preview Mode)**

Switch to confirmation screen by pressing the preview button.

- Normal recording screen
- Aperture effect preview screen
- Shutter speed effect preview screen

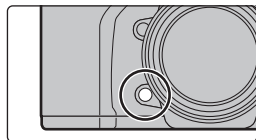



## [LVF] button (Switching the Monitor/Viewfinder)

### Press [LVF].

- Ⓐ [LVF] button
- Ⓑ Eye sensor

- The monitor/viewfinder will switch as follows:
  - Automatic viewfinder/monitor switching\*
  - Viewfinder display\*
  - Monitor display

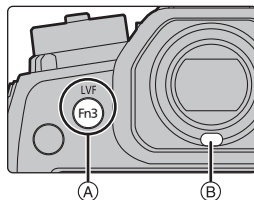

- \* If [Eye Sensor AF] in the [Custom] ([Focus / Release Shutter]) menu is set to [ON], the camera automatically adjusts the focus as the eye sensor is activated. The camera does not beep when focus is achieved with [Eye Sensor AF].

### ■ Notes on automatic viewfinder/monitor switching

Bring your eye or an object near the viewfinder to automatically switch to the viewfinder display using the eye sensor.

- To reduce the battery consumption, set [Power Save LVF Shooting] in [Economy].

## Change the display magnification of the viewfinder

### Press [V.MODE].

- The magnification factors that can be switched between differ depending on the [LVF/Monitor Disp. Set] setting in the [Custom] ([Monitor / Display]) menu.
  - [📺] (Viewfinder Style): Two levels
  - [📺] (Monitor Style): Three levels

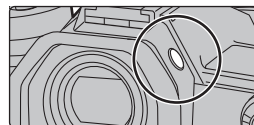

## [DISP.] button (Switching the displayed information)

### Press [DISP.].

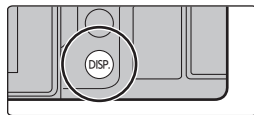

## In Recording Mode

You can select separate screen display styles for the viewfinder and the monitor.

**MENU** → **☞ [Custom]** → **📺 [Monitor / Display]** → **[LVF/Monitor Disp. Set]** → **[LVF Disp. Set]/[Monitor Disp. Set]**

[📺] (viewfinder style)	Scales down images slightly so that you can better review the composition of the images.
[📺] (monitor style)	Scales images to fill the entire screen so that you can see their details.

•  Live View Finder style display layout (Example of viewfinder style display)

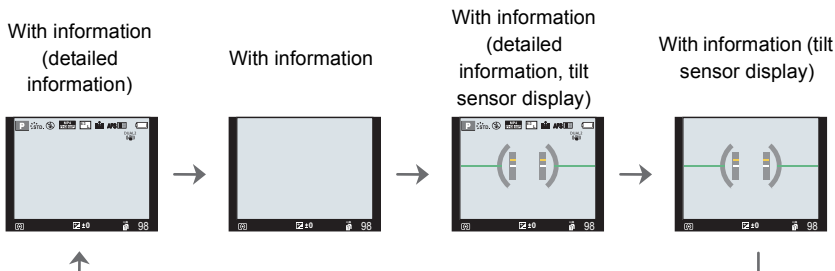

•  Monitor style display layout (Example of monitor style display)

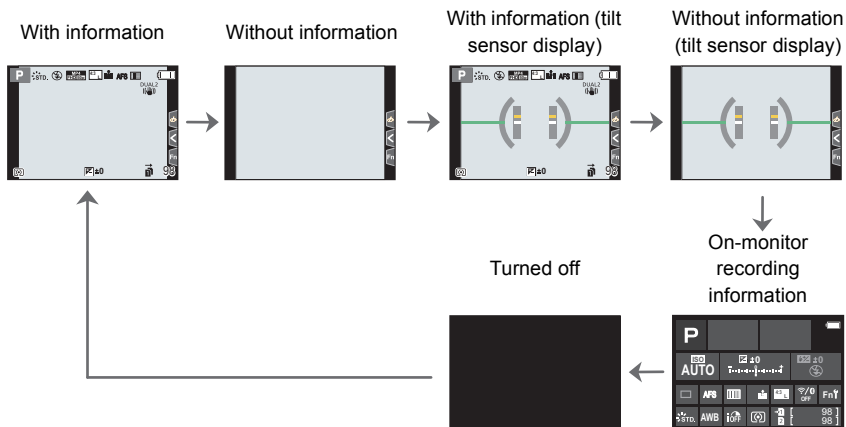

### In Playback Mode

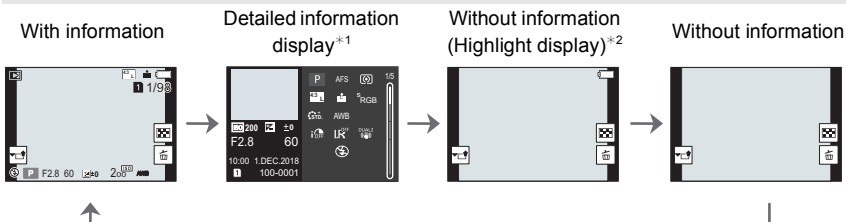

\*1 Press ▲/▼ to switch between the following display modes:

- Detailed information display
- Histogram display
- Photo style, Highlight shadow display
- White balance display
- Lens information display

\*2 This is displayed if [Highlight] in the [Custom] ([Monitor / Display]) menu is set to [ON].

## Touch screen (Touch operations)

### ■ Touch

To touch and release the touch screen.

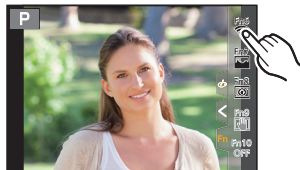

### ■ Drag

A movement without releasing the touch screen.

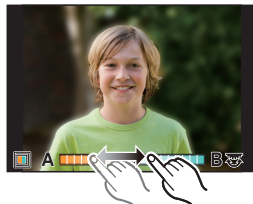

### ■ Pinch (enlarge/reduce)



Pinch the touch screen apart (enlarge) or together (reduce) with two fingers.



### ■ Taking Pictures Using the Touch Function

- 1 Touch [P].
- 2 Touch icon.



 <b>Touch Shutter</b>	<p>Just by touching the subject you want as your point of focus, the camera will focus on the subject and take the picture automatically.</p> <p><b>Touch the subject you wish to focus on, and then take a picture.</b></p>
 <b>Touch AE</b>	<p>You can easily optimise the brightness for a touched position.</p> <ol style="list-style-type: none"> <li>① Touch the subject you want to optimise the brightness for.</li> <li>② Touch [Set].</li> </ol>

- To cancel the function, touch [ ] or [AE].

# Setting menu items

**1** Press [MENU/SET].

**2** Press ◀.

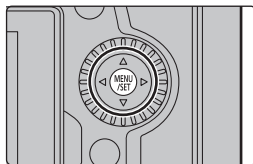

**3** Press ▲/▼ to select a menu selector icon, such as [📷].

- You can also select the menu toggle icons by rotating the front dial.



[Intelligent Auto] (P73)	These menus let you set the functions available only for their corresponding Recording Modes.
[Creative Video] (P73)	
[Custom Mode] (P73)	
[Creative Control] (P73)	
[Rec] (P73)	This menu lets you set picture settings.
[Motion Picture] (P74)	This menu lets you set motion picture settings.
[Custom] (P74)	Operation of the unit, such as displaying of the screen and button operations, can be set up according to your preferences.
[Setup] (P75)	This menu lets you perform the clock settings, select the operating beep tone settings and set other settings which make it easier for you to operate the camera. You can also configure the settings of Wi-Fi/Bluetooth related functions.
[My Menu] (P86)	This menu lets you register frequently-used menus.
[Playback] (P75)	This menu lets you set the playback and editing settings for images.

**4** Press [MENU/SET].

**5** Press ▲/▼ of the cursor button to select the menu item and press [MENU/SET].

## 6 Press ▲/▼ of the cursor button to select the setting and press [MENU/SET].

- Depending on the menu item, its setting may not appear or it may be displayed in a different way.

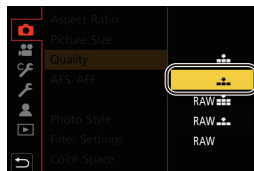

- Menu items that are not available are displayed in grey. When a grey item is selected, if you press [MENU/SET], a message indicating that the item cannot be set is displayed along with the reason why it cannot be set under certain conditions.



### ■ Close the menu

Press [↵] or press the shutter button halfway.

## Calling frequently-used menus instantly (Quick Menu)

- Press [Q.MENU] to display the Quick Menu.
- Rotate the front dial to select the menu item.
- Rotate the rear dial to select the setting.
- Press [Q.MENU] to exit the menu once the setting is complete.

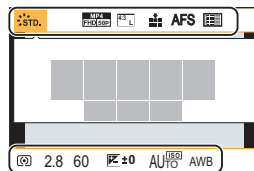

# Assigning Frequently-Used Functions to Buttons/Lever (Function Buttons/Function Lever)

You can assign various features, such as recording functions, to specific buttons and icons as well as the function lever.

## Assigning functions to function buttons

### 1 Select the menu.

**MENU** →  [Custom] →  [Operation] → [Fn Button Set] → [Setting in REC mode]/[Setting in PLAY mode]

### 2 Press ▲/▼ to select the function button you want to assign a function to and then press [MENU/SET].

- To select a button from [Fn11] to [Fn19] in [Setting in REC mode], press [DISP.] to switch the screen.

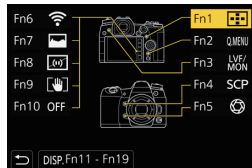

### 3 Press ▲/▼ to select the function you want to assign and then press [MENU/SET].

- If you press and hold a function button (any of [Fn1] to [Fn5] or [Fn11] to [Fn19]) for 2 seconds, the screen displayed in step 3 can be displayed.

In some cases, however, the screen cannot be displayed depending on the currently selected mode or the currently displayed screen.

## ■ Functions that can be assigned in [Setting in REC mode]

<ul style="list-style-type: none"> <li>- [Wi-Fi]: [Fn6]*</li> <li>- [Q.MENU]: [Fn2]*</li> <li>- [Video Record]</li> <li>- [LVF/Monitor Switch]: [Fn3]*</li> <li>- [LVF/Monitor Disp. Style]</li> <li>- [AF-Point Scope]: [Fn4]*</li> <li>- [AF/AE LOCK]</li> <li>- [AF-ON]</li> <li>- [Preview]: [Fn5]*</li> <li>- [One Push AE]</li> <li>- [Touch AE]</li> <li>- [Level Gauge]: [Fn8]*</li> <li>- [Focus Area Set]</li> <li>- [Zoom Control]</li> <li>- [1 Shot RAW+JPG]</li> <li>- [1 Shot Spot Metering]</li> <li>- [1 Shot "6K/4K PHOTO"]</li> <li>- [Operation Lock]</li> <li>- [Dial Operation Switch]</li> <li>- [Destination Slot]</li> <li>- [Photo Style]</li> <li>- [Filter Effect]</li> <li>- [Aspect Ratio]</li> <li>- [Picture Size]</li> </ul>	<ul style="list-style-type: none"> <li>- [Quality]</li> <li>- [AFS/AFF]</li> <li>- [Metering Mode]</li> <li>- [Burst Shot Setting]</li> <li>- [6K/4K PHOTO]</li> <li>- [Self Timer]</li> <li>- [High Resolution Mode]</li> <li>- [Bracket]</li> <li>- [Highlight Shadow]</li> <li>- [i.Dynamic]</li> <li>- [i.Resolution]</li> <li>- [Min. Shtr Speed]</li> <li>- [Post Focus]</li> <li>- [HDR]</li> <li>- [Shutter Type]</li> <li>- [Flash Mode]</li> <li>- [Flash Adjust.]</li> <li>- [Wireless Flash Setup]</li> <li>- [Ex. Tele Conv.]</li> <li>- [Digital Zoom]</li> <li>- [Stabilizer]</li> <li>- [I.S. Lock (Video)]: [Fn9]*</li> <li>- [4K Live Cropping]</li> <li>- [Motion Pic. Set]</li> </ul>	<ul style="list-style-type: none"> <li>- [Picture Mode in Rec.]</li> <li>- [Mic Level Adj.]</li> <li>- [Mic. Directivity Adjust]</li> <li>- [Silent Mode]</li> <li>- [Peaking]</li> <li>- [Histogram]: [Fn7]*</li> <li>- [Guide Line]</li> <li>- [Zebra Pattern]</li> <li>- [Monochrome Live View]</li> <li>- [Constant Preview]</li> <li>- [Rec Area]</li> <li>- [Step Zoom]</li> <li>- [Zoom Speed]</li> <li>- [Night Mode]</li> <li>- [Exposure Comp.]</li> <li>- [Sensitivity]</li> <li>- [White Balance]</li> <li>- Each item in [White Balance]</li> <li>- Each item in [Photo Style]</li> <li>- [AF Mode/MF]: [Fn1]*</li> <li>- [Rec / Playback Switch]</li> <li>- [Off]</li> <li>- [Restore to Default]</li> </ul>
---	---	--

\* Function button settings at the time of purchase.

• By default, [Off] is assigned to the buttons [Fn10] to [Fn19].

## Assigning a function to the function lever

Register a function and its setting that operate when you set the function lever (P22) to [MODE2].

### 1 Select the menu.

**MENU** → [Custom] → [Operation] → [Fn Lever Setting] → [Function of Fn Lever]

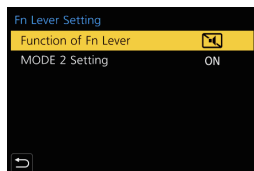

### 2 Press ▲/▼ to select the function you want to assign, and press [MENU/SET].

– [AF Mode]	– [Bracket]
– [Quality]	– [Touch Screen]
– [Photo Style]	– [Touch Pad AF]
– [Long Shtr NR]	– [Auto Review (Photo)]
– [Stabilizer]	– [Peaking]
– [6K/4K PHOTO (Pre-Burst)]	– [Night Mode]
– [Self Timer]	– [Front/Rear/Control Dial Lock]
– [Silent Mode]*	– [Off]
– [Shutter Type]	– [Restore to Default]

\* Default function lever setting.

### 3 Press ▲/▼ to select [MODE 2 Setting], and press [MENU/SET].

### 4 Press ▲/▼ to select the function setting selected in step 2, and press [MENU/SET].

- The screen shown here is an example, where [Self Timer] has been assigned to register it in combination with the [] setting.

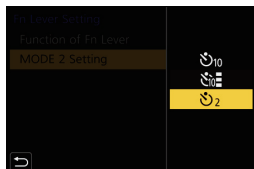



# Taking Pictures using the Automatic Function (Intelligent Auto Mode)

Recording Mode:  

In this mode, the camera makes the optimal settings for the subject and scene.

## 1 Set the mode dial to [iA].

- At the time of purchase, the mode is set to Intelligent Auto Plus Mode.

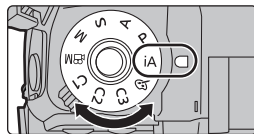

## 2 Align the screen with the subject.

- When the camera identifies the optimum scene, the icon of the scene concerned will change. (Automatic Scene Detection)



- When [iHandheld Night Shot] is set to [ON] and [iA+] is detected while taking handheld night shots, pictures of the night scenery will be taken at a high burst speed and composed into a single picture.
- When [iHDR] is set to [ON] and there is, for example, strong contrast between the background and the subject, multiple still pictures are recorded with differing exposures and combined to create a single still picture rich in gradation.

### ■ Switching between Intelligent Auto Plus Mode and Intelligent Auto Mode

Intelligent Auto Plus Mode allows you to adjust some settings such as the brightness, colour tone and defocus control while also using Intelligent Auto Mode for other settings.





#### 1 Select the menu.

**MENU** →  **[Intelligent Auto]** → **[Intelligent Auto Mode]**





#### 2 Press ▲/▼ to select [] or [] and then press [MENU/SET].

### ■ Auto Focus, Face/Eye Detection, and Face Recognition

The Auto Focus Mode is automatically set to []. If you touch the subject, the AF tracking function will work.

- The AF tracking function will also work if you press [] and then press the shutter button halfway.
- You cannot specify the person or eye to be brought into focus when using [].
- When [Face Recog.] is set to [ON], and the face similar to the registered face is detected, [R] is displayed in the top right of [], [] and [].

### ■ About the flash

When recording with the flash, the camera automatically selects [], [] (AUTO/Red-Eye Reduction), [] or [] according to the type and brightness of the subject.

## Taking pictures with customised colour, defocus control, and brightness settings

Recording Mode: 

### ■ Setting colour

1 Press [WB].

2 Rotate the rear dial to adjust colour.

- To return to the recording screen, press [WB] again.
- The colour setting will return to the default level (centre point) when this unit is turned off or the camera is switched to another Recording Mode.

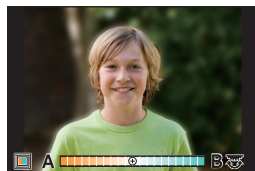

### ■ Taking a picture with a blurred background (Defocus Control)

1 Press [] to display the brightness setting screen.

2 Press [Fn1] to display the setting screen.

3 Set the blurriness by rotating the rear dial.

- To return to the recording screen, press [MENU/SET].
- To cancel the setting, press [Fn2] on the blurriness setting screen.



### ■ Setting brightness

1 Press [].

2 Rotate the rear dial to adjust brightness.

- You can adjust the Exposure Bracket setting by pressing ▲/▼ while the brightness setting screen is displayed. (P57)
- To return to the recording screen, press [] again.

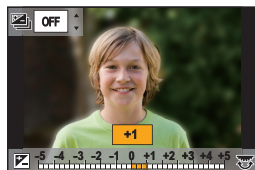

# Setting the Focus Mode (AFS/AFF/AFC)

Applicable modes:   **P** **A** **S** **M**  

The method for achieving focus when the shutter button is pressed halfway is set.

**Set the focus mode lever.**

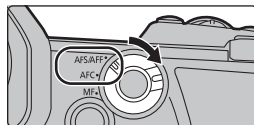

Item		Scene (recommended)	
[AFS/ AFF]	[AFS]	Subject is still (Scenery, anniversary photograph, etc.)	"AFS" is an abbreviation of "Auto Focus Single". The focus stays locked while the shutter button is pressed halfway, so you can perform recording while changing the composition.
	[AFF]	Movement cannot be predicted (Children, pets, etc.)	"AFF" is an abbreviation of "Auto Focus Flexible". If the subject moves while the shutter button is pressed halfway, the focus is readjusted automatically according to the movement of the subject.
		You can switch the setting with [AFS/AFF] in the [Rec]/[Motion Picture] menu.	
[AFC]		Subject is moving (Sport, trains, etc.)	"AFC" is an abbreviation of "Auto Focus Continuous". In this mode, while the shutter button is pressed halfway, focusing is constantly performed to match the movement of the subject.
[MF]		Set the focus manually. (P41)	

- When recording with [AFF] or [AFC], the camera predicts the motion of moving subjects to bring them into focus. (Moving Object Prediction)

## Customising the operation settings of Auto Focus for picture taking

Applicable modes:   **P** **A** **S** **M**  

- This item works only when the Focus Mode is set to [AFF] or [AFC].

**MENU** →  **[Rec]** → **[AF Custom Setting(Photo)]**

[Set 1]	This is a basic general purpose setting.
[Set 2]	This is a setting suited for scenes where the subject moves in only one direction at a constant speed.
[Set 3]	This is a setting suited for scenes where the subject moves in random directions and obstacles are likely to appear in the image.
[Set 4]	This is a setting suited for scenes where the speed of the subject changes significantly.

## ■ Adjusting the AF Custom settings

- 1 Press ◀/▶ to select the AF Custom setting.
- 2 Press ▲/▼ to select the items, and then press ◀/▶ to adjust.
  - To reset to the default settings, press [DISP].

[AF Sensitivity]	Sets the sensitivity to be applied when adjusting the focus according to the movement of the subject.
[AF Area Switching Sensitivity]	Sets the sensitivity level at which the camera switches or moves the AF area to suit the movement of the subject.
[Moving Object Prediction]	Sets the level at which object motion detection is activated in response to a change in the speed of the subject.

- 3 Press [MENU/SET].

## Setting the Auto Focus Mode

Applicable modes: P A S M

This allows the focusing method that suits the positions and number of the subjects to be selected.

Press [].

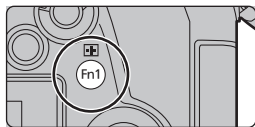

([Face/Eye Detection])





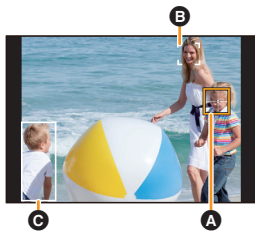

A person's face, eyes, and body (the entire body or the upper half of the body) are automatically detected.

- When the camera detects a person's face (A, B) or body (C), an AF area is displayed over the detected person.
- When a person's face or eyes are detected, the eye closer to the camera will be brought into focus.\*

\* The exposure will be adjusted to the face. (When [Metering Mode] is set to [])



- When a person's body is detected, it will be brought into focus.
- The camera can detect the faces of up to 15 people.
- To specify the person or eye to be brought into focus, align an AF area with the desired person or eye. You can do so easily by touching a person indicated with an AF area. To cancel the setting, touch [].



 <b>[[Tracking]]</b>	<p>The camera keeps adjusting the focus and exposure automatically to the specified moving object. (Dynamic Tracking)          (When [Metering Mode] is set to [☉])</p> <ul style="list-style-type: none"> <li>• Aim the AF tracking area over the subject to be tracked, and press the shutter button halfway to lock the subject.</li> <li>• Lock is cancelled when [MENU/SET] is pressed.</li> </ul>	
 <b>[[225-Area]]</b>	<p>Up to 225 AF areas can be focused.          This is effective when a subject is not in the centre of the screen.</p>	
 <b>[[Custom Multi]]</b>	<p>From among 225 AF areas, you can freely set the optimum shape of the AF area for the subject. (P38)</p>	
 <b>[[1-Area]]</b>	<p>The camera focuses on the subject in the AF area on the screen.</p>	
 <b>[[Pinpoint]]</b>	<p>You can achieve a more precise focus on a point that is smaller than .</p> <p>If you press the shutter button halfway, the screen that lets you check the focus will be enlarged.</p>	

### ■ Displaying the AF area position in the magnification window (AF Point Scope)

You can temporarily display the magnification window to check the AF area position and focus.

- When using the  or  mode or a mode such as  ([Custom Multi]), the centre area of the screen will be displayed in the magnification window.

### Press and hold [Fn4] while the recording screen is displayed.

- The Focus Mode will change to [AFS]. When you press the shutter button halfway, the focus will be readjusted with a smaller AF area.
- You can rotate the front/rear dial to adjust the magnification factor.



: Magnifies/reduces the window in small steps



: Magnifies/reduces the window in large steps

- The AF area position and the magnification window position cannot be changed.



### Setting the methods for displaying the magnification window

**MENU** →  [Custom] →  [Focus / Release Shutter] → **[AF-Point Scope Setting]**

<b>[Keep Enlarged Display]</b>	<p><b>[ON]:</b> Displays/hides the magnification window each time the appropriate function button is pressed.</p> <p><b>[OFF]:</b> Displays the magnification window while the appropriate function button is pressed and held.</p>
<b>[PIP Display]</b>	<p><b>[FULL]:</b> Displays the window in full screen mode.</p> <p><b>[PIP]:</b> Displays the window in windowed mode.</p>

## ■ Setting the shape of the AF area ([Custom Multi])

- 1 Press [ ].
- 2 Select a Custom Multi icon ([ ], etc.), and press ▲.
- 3 Press ◀/▶ to select a setting and then press ▼.

(A) The current shape of the AF area

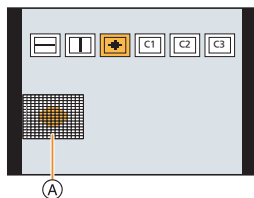

 ([Horizontal Pattern])	This shape is convenient for taking panning shots or similar shots.
 ([Vertical Pattern])	This shape is convenient for recording objects, such as buildings.
 ([Central Pattern])	This shape is convenient when you want to bring the centre area into focus.
 ([Custom1]/ [Custom2]/[Custom3])	You can select a customised setting.

## 4 Select AF areas.

(B) The selected AF areas

When selecting [ ]/[ ]/[ ]

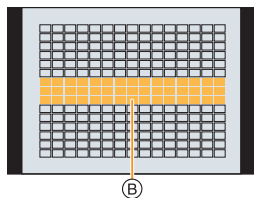

Button operation	Touch operation	Description of operation
▲/▼/◀/▶	Touching	Moves the position
	Pinching in/out	Changes the size
[DISP.]	[Reset]	First time: The position is reset to the centre Second time: The size is reset to the default

Press [MENU/SET] to set.

When selecting [ ]/[ ]/[ ]

Touch operation

Drag your finger over the parts you want to set as AF areas.

- To cancel the selection of a particular AF area, touch the area again.

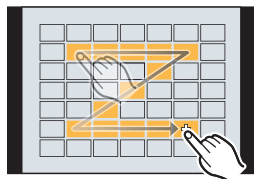

Button operation

Press ▲/▼/◀/▶ to select the AF area, and then press [MENU/SET] to set (repeat).

- The setting is cancelled when [MENU/SET] is pressed again.

Press [Fn1] to set.

## ■ Registering the set AF area to [C1], [C2] or [C3]

- 1 On the screen in step 3 on P38, press ▲.
- 2 Press ▲/▼ to select a destination to which the setting will be registered, and press [MENU/SET].

## Specifying the AF area position



- When [Focus Switching for Vert / Hor] in the [Custom] ([Focus / Release Shutter]) menu is set, the last specified positions of the AF area (when [■], [⦶] or [+] is set) and the MF Assist display are stored separately for the camera's horizontal and vertical orientations (two vertical orientations, left and right, are available).

### Specifying the AF area position on the setting screen

Applicable modes:   **P A S M**  

#### ■ When selecting [⦶], [⦶], [⦶], [■]

- 1 Press [⦶].
- 2 Select [⦶], [⦶], [⦶] or [■] and press ▼.
- 3 Change the position and size of the AF area.
  - If you have selected [⦶], you can set the lock-on position by changing the AF area position.
  - To specify the person or eye to be brought into focus when [⦶] has been selected, align any of the AF areas currently indicating human subjects with the desired person or eye. For any position where a person or eye is not located, an AF area that operates in the same way as [■] will be set.
  - Press [MENU/SET] or touch  to cancel the AF area settings when using [⦶], [⦶] or [⦶].

Button operation	Touch operation	Description of operation
	Touching	Moves the position
	Pinching out/in	Changes the size
[DISP.]	[Reset]	First time: The position is reset to the centre Second time: The size is reset to the default



- 4 Press [MENU/SET] to set.

## ■ When selecting [+]

- 1 Press [].
- 2 Select [+ ] and press ▼.
- 3 Press ▲/▼/◀/▶ to set the focus position and then press [MENU/SET].
- 4 Move [+ ] to the position to be in focus.

Button operation	Touch operation	Description of operation
▲/▼/◀/▶	Touching	Moves [+].
	Pinching out/in	Enlarges/reduces the screen.
		Switches the enlarged display (windowed/full screen).
[DISP.]	[Reset]	Returns you to the screen in step 3.

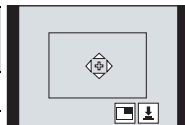

- 5 Press [MENU/SET] to set.

## Specifying the AF area position with the joystick

Applicable modes: P A S M

### 1 Select the menu.

**MENU** → [Custom] → [Operation] → [Joystick Setting] → [D.FOCUS Movement]

### 2 Display the recording screen, and move the joystick ▲/▼/◀/▶ to move the AF area.

- You can change the size of the AF area by rotating the front/rear dial.
- Press the joystick to switch between the default AF area position and the position you have set. The enlarged display will appear when [] ([Pinpoint]) is set.



### 3 Press the shutter button halfway to set.

- Press the joystick while the recording screen is displayed to switch between the default AF area position and the position you have set.



# Adjusting Focus Manually

Applicable modes:   **P** **A** **S** **M**  

Use this function when you want to fix the focus or when the distance between the lens and the subject is determined and you do not want to activate Auto Focus.

- 1** Set the focus mode lever to **[MF]**.
- 2** Press **[MF]**.
- 3** Press **▲/▼/◀/▶** to adjust the focus position, and press **[MENU/SET]**.
- 4** Adjust the focus.

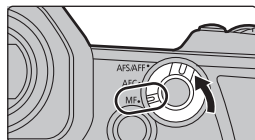

When using an interchangeable lens (H-ES12060) with a focus ring

Rotate to **A** side:

Focuses on nearby subject

Rotate to **B** side:

Focuses on faraway subject

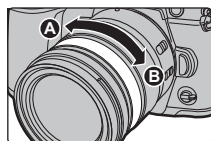

**A** MF Assist (enlarged screen)



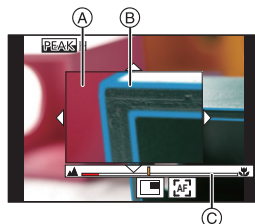

**B** Peaking

**C** MF Guide

- In-focus portions are highlighted with colour. ([Peaking])
- You can check whether the point of focus is to the near side or to the far side. (MF Guide)



You can perform the following operations:

Button operation	Touch operation	Description of operation
<b>▲/▼/◀/▶</b>	<b>Dragging</b>	Moves the enlarged area.
	<b>Pinching out/in</b>	Enlarges/reduces the screen in small steps.
	—	Enlarges/reduces the screen in large steps.
		Switches the enlarged display (windowed/full screen).
<b>[DISP.]</b>	<b>[Reset]</b>	The position of the enlarged area is reset to the centre.

- 5** Press the shutter button halfway.

- You can also perform the same operation by pressing **[MENU/SET]**.

## Fixing the Focus and the Exposure (AF/AE Lock)

Applicable modes:  P A S M 

Lock the focus and exposure in advance to take pictures with the same focus and exposure settings while changing the composition.

This is useful when you want to bring an edge of the screen into focus or there is a backlight, for example.

- 1 Align the screen with the subject.
- 2 Press and hold [AF/AE LOCK] to fix the focus or exposure.

- If you release [AF/AE LOCK], AF/AE Lock is cancelled.
- Only the exposure is locked in the default setting.

- 3 While pressing [AF/AE LOCK], move the camera as you compose the picture and then press shutter button fully.

(A) AE Lock indication

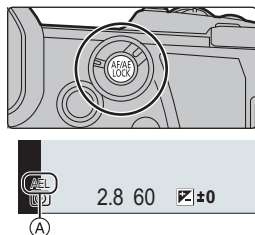

## Compensating the Exposure



Applicable modes:  P A S M 

Use this function when you cannot achieve appropriate exposure due to the difference in brightness between the subject and the background.

- 1 Press [].
- 2 Rotate the rear dial to compensate the exposure.

- (A) Exposure Bracket  
(B) Exposure Compensation  
(C) [Flash Adjust.]

- You can perform the operations below while the exposure compensation screen is displayed.

	Compensates the exposure
	Adjusts the flash output
	Sets the exposure bracket (P57)

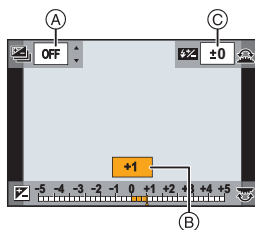

- You can switch the functions between the rear dial and the front dial by pressing [DISP.].

- 3 Press [] to set.

- In Manual Exposure Mode, you can compensate the exposure only when the ISO sensitivity is set to [AUTO].

# Setting the Light Sensitivity

Applicable modes:   **P** **A** **S** **M**  

This allows the sensitivity to light (ISO sensitivity) to be set.

## 1 Press [ISO].

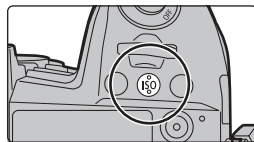

## 2 Select the ISO sensitivity by rotating the rear dial.

- You can switch the functions between the rear dial and the front dial by pressing [DISP].

(A) [ISO Auto Upper Limit Setting]

(B) ISO sensitivity

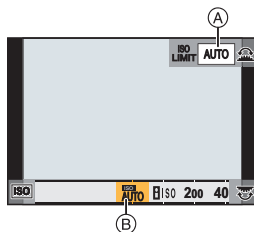

## 3 Rotate the front dial to set the [ISO Auto Upper Limit Setting].

- Set the [ISO Auto Upper Limit Setting] in [ISO Sensitivity (photo)] (or in [ISO Sensitivity (video)] when using Creative Video Mode).
- It will work when the [Sensitivity] is set to [AUTO] or [ISO].

## 4 Press [ISO] to set.

<b>AUTO</b>	The ISO sensitivity is automatically adjusted according to the brightness.
 <b>ISO (Intelligent)</b>	The camera automatically sets the optimum ISO sensitivity and shutter speed to suit the movement of the subject and brightness of the scene to minimise the jitter of the subject.
<b>L.100*</b> , from 200 to 25600	The ISO sensitivity is fixed to various settings.

\* Only when [Extended ISO] in the [Custom] ([Exposure]) menu is used.

# Adjusting the White Balance

Applicable modes:   **P** **A** **S** **M**  

White Balance adjusts the colour of white according to the light source to make the overall colour hue closer to what is seen by the eye.



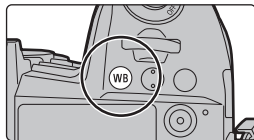

## 1 Press [WB].











## 2 Rotate the rear dial or front dial to select the White Balance.

- Setting can also be performed by rotating the control dial.



<p><b>[AWB]/ [AWBc]</b></p>	<p>Adjusting the White Balance automatically</p> <ul style="list-style-type: none"> <li>Under lighting such as incandescent lighting where reddish tones may occur:           <ul style="list-style-type: none"> <li>With [AWB], reddish tones are maintained to reproduce the ambience of the scene more accurately.</li> <li>With [AWBc], reddish tones are suppressed to reproduce the original colours of the subject more accurately. The same tones as [AWB] may be applied in a bright environment.</li> </ul> </li> <li>[AWB] and [AWBc] apply the same tones under light sources where reddish tones may not occur.</li> </ul>
<p></p>	<p>When taking pictures outdoors under a clear sky</p>
<p></p>	<p>When taking pictures outdoors under a cloudy sky</p>
<p></p>	<p>When taking pictures outdoors in the shade</p>
<p></p>	<p>When taking pictures under incandescent lights</p>

[  ]	When taking pictures with the flash only
 /  /  / 	Set the White Balance value. Use to match the condition when taking photographs. ❶ Press ▲. ❷ Place a white object such as a piece of paper within the frame at the centre of the screen, and press [MENU/SET]. • This will set the White Balance and return you to the recording screen.
 /  /  / 	You can set the colour temperature manually for taking natural pictures in different lighting conditions. ❶ Press ▲. ❷ Press ▲/▼ to select the colour temperature and then press [MENU/SET].

\* [AWB] is applied when you record motion picture or perform recording with the 6K/4K Photo or Post Focus function.

### 3 Press [WB] to set.

#### Finely adjusting the White Balance

You can finely adjust the White Balance when you cannot acquire the desired hue by setting the White Balance.

- 1 Select the White Balance and then press ▼.
- 2 Press ▲/▼/◀/▶ to fine-adjust the White Balance.
  - ◀: [A] (AMBER: ORANGE)
  - ▶: [B] (BLUE: BLUISH)
  - ▲: [G] (GREEN: GREENISH)
  - ▼: [M] (MAGENTA: REDDISH)
- 3 Press [MENU/SET].

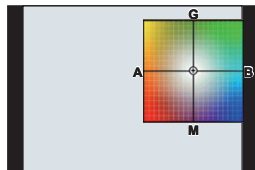





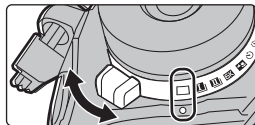

# Select a Drive Mode

Applicable modes: 

You can change what the camera will do when you press the shutter button.

## Rotating the drive mode dial.



<input type="checkbox"/> [Single]	When the shutter button is pressed, only one picture is recorded.
 [Burst] (P47)	Recordings are made in succession while the shutter button is pressed.
 [6K/4K PHOTO] (P48)	Performs 6K/4K photo recording.
 [Post Focus] (P52)	Performs Post Focus recording.
 [Self Timer]	<p>When the shutter button is pressed, recording takes place after the set time has elapsed.</p> <ol style="list-style-type: none"> <li>Set the drive mode dial to [🕒].</li> <li>Press the shutter button halfway to focus and then press it fully to take the picture.</li> </ol> <ul style="list-style-type: none"> <li>Focus and exposure will be set when the shutter button is pressed halfway.</li> <li>After the self-timer indicator flashes, recording starts.</li> </ul>
 [Time Lapse/Animation] (P54)	Pictures are recorded with Time Lapse Shot or Stop Motion Animation.

# Taking Pictures using Burst Mode

Applicable modes: 

- You can apply different Burst Mode settings to [**I1**] (Burst Shot 1) and [**I2**] (Burst Shot 2) by setting [Burst Shot 1 Setting] and [Burst Shot 2 Setting] in the [Rec] menu.

**1** Set the drive mode dial to [**I1**] (Burst Shot 1) or [**I2**] (Burst Shot 2).

**2** Select the Burst Mode setting.

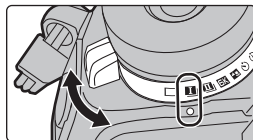

MENU →  [Rec] → [Burst Shot 1 Setting]/  
[Burst Shot 2 Setting]

[SH2]	Performs super high-speed burst recording with the electronic shutter.
[SH1]	• The burst speed will be faster with [SH2] than with [SH1].
[SH2 PRE]	Performs super high-speed burst recording with the electronic shutter. Pictures taken at the moment before the shutter button is pressed fully (a maximum of 0.4 seconds) will be saved in addition to those taken after it is pressed fully.
[SH1 PRE]	• The burst speed will be faster with [SH2 PRE] than with [SH1 PRE].
[H]	Performs high-speed burst recording.
[M]	Performs medium-speed burst recording.
[L]	Performs low-speed burst recording.

**3** Focus on the subject and take a picture.

- Hold down the shutter button fully to activate the Burst Mode.
  - When [SH2] or [SH1] has been selected: If you press the shutter button halfway first and then press it fully, you can perform recording without a delay that occurs after it is pressed fully.
- 
- When [SH2 PRE] or [SH1 PRE] has been selected:
- Press the shutter button halfway.
  - Press and hold the shutter button fully.
- Recording starts when the shutter button is pressed halfway. [PRE] is displayed on the recording screen.
  - If approx. 1 minute elapses while the shutter button is pressed and held halfway, press it halfway again.**  
When approx. 1 minute elapses while the shutter button is pressed and held halfway, the camera will not be able to save pictures taken before the shutter button is pressed fully.

**Notes on super high-speed burst recording ([SH2]/[SH1]/[SH2 PRE]/[SH1 PRE])**

- Shutter speeds slower than 1/60 seconds are not available.
- The aperture will be fixed during burst recording
- To protect the camera, even if you press the shutter button halfway, Pre-Burst may not operate when the camera's temperature has risen due to, for example, high ambient temperature or continuous Pre-Burst recording. Wait until the camera cools down.
- Even if you press the shutter button halfway, Pre-Burst may not operate when there is insufficient free space on the card.

## Recording 6K/4K Photos

**Applicable modes:**   **P** **A** **S** **M**  

With 6K Photo, you can take a high-speed burst of pictures at 30 frames/second and save the desired pictures, each made up of 18 million pixels (approx.), extracted from their burst file. With 4K Photo, you can take a high-speed burst of pictures at 60 frames/second and save the desired pictures, each made up of 8 million pixels (approx.).

- “6K PHOTO” is a high-speed burst recording function which allows you to save pictures extracted from images recorded with an aspect ratio for still pictures, 4:3 or 3:2, and with an effective picture size equivalent to a particular number of pixels (approx. 18 megapixels) produced by images with a size of 6K (approx. 6,000 (horizontal)×3,000 (vertical)).
- Use a UHS Speed Class 3 card.

### 1 Set the drive mode dial to [6K].

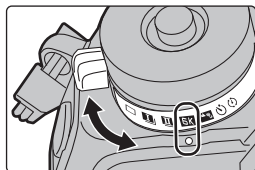

### 2 Select the picture size and burst speed.

**MENU** →  **[Rec]** → **[6K/4K PHOTO]** → **[Picture Size / Burst Speed]**

<b>[6K 18M]</b>	[4:3]: (4992×3744)	[3:2]: (5184×3456)	30 pictures/second
<b>[4K H 8M]</b>	[4:3]: (3328×2496)	[3:2]: (3504×2336)	60 pictures/second
<b>[4K 8M]</b>	[16:9]: (3840×2160)	[1:1]: (2880×2880)	30 pictures/second



### 3 Select the recording method.

MENU → [Rec] → [6K/4K PHOTO] → [Rec Method]

<p>[6K/4K Burst]*</p>	<p><b>For capturing the best shot of a fast-moving subject</b></p> <p>Burst recording is performed while the shutter button is pressed and held.</p> <p>(A) Press and hold (B) Recording is performed</p>	
<p>[6K/4K Burst(S/S)]*</p> <p>"S/S" is an abbreviation of Start/Stop.</p>	<p><b>For capturing unpredictable photo opportunities</b></p> <p>Burst recording starts when the shutter button is pressed and stops when pressed again.</p> <p>(C) Start (First) (D) Stop (Second) (E) Recording is performed</p>	
<p>[6K/4K Pre-Burst]</p>	<p><b>For recording as needed whenever a photo opportunity arises</b></p> <p>Burst recording is performed for approximately 1 second before and after the moment that the shutter button is pressed.</p> <p>(F) Approximately 1 second (G) Recording is performed</p>	

- \* If [Picture Size / Burst Speed] is set to [6K 18M] or [4K H 8M]:  
Recording stops when the continuous recording time exceeds 10 minutes.
- If [Picture Size / Burst Speed] is set to [4K 8M]:  
Recording stops when the continuous recording time exceeds 29 minutes and 59 seconds.
- When using an SDHC memory card, you can continue the recording of a 6K/4K photo without interruption even if the file size exceeds 4 GB, but its burst file will be divided into smaller files for recording and playback.
  - With an SDXC memory card, you can save a burst file size exceeding 4 GB as a single file.

**4 Press the shutter button halfway to exit the menu.**

**5 Press the shutter button to perform recording.**

- The camera will perform burst recording of a 6K/4K photo and saves it as a 6K/4K burst file with a [Rec Format] setting of [MP4].
- When [Auto Review] is enabled, the picture selection screen will be displayed automatically.
- **When the ambient temperature is high or 6K/4K photo recording is performed continuously, the camera may display [△] and recording may stop. If you are using [6K/4K Pre-Burst], the setting will switch to [6K/4K Burst] and recording will stop. Wait until the camera cools down.**
- **When [6K/4K Pre-Burst] or [Pre-Burst Recording] is set, the battery drains faster and the camera temperature rises. Use these functions only when recording with them.**

### ■ Adding markers to select and save pictures ([6K/4K Burst(S/S)])

You can add markers if you press [Fn2] during recording. (Up to 40 markers per recording)  
When selecting and saving pictures from a 6K/4K burst file, you can skip to the positions where you added markers.

### ■ Setting Pre-Burst Recording ([6K/4K Burst]/[6K/4K Burst(S/S)])

The camera starts recording approximately 1 second before the shutter button is pressed fully, so you will not miss a photo opportunity.

**MENU** → **📷 [Rec]** → **[6K/4K PHOTO]** → **[Pre-Burst Recording]** → **[ON]**

- Auto Focus operation settings and menus that cannot be set while this function is in use are the same as those during [6K/4K Pre-Burst] operation.

## Selecting pictures from 6K/4K burst file and saving

- 1 Select an image with the [📷] or [📷] icon on the playback screen, and press ▲.**

- If the image was recorded with [6K/4K Pre-Burst], proceed to step 3.



- 2 Drag the slide bar to make a rough selection of scenes.**

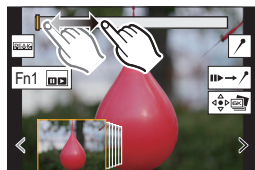

- 3 Drag the frames to select the frame you want to save as a picture.**

- To continuously rewind/forward frame-by-frame, touch and hold [ < ]/[ > ].

- 4 Touch [📷] or [📷] to save the picture.**

- A confirmation screen will be displayed.
- The picture will be saved in JPEG format.



## ■ Saving pictures taken with the 6K/4K Photo function at once ([6K/4K PHOTO Bulk Saving])

You can save pictures of a 6K/4K burst file that were extracted from any 5 second period at once.

### 1 Select the menu.

**MENU** →  **[Playback]** → **[6K/4K PHOTO Bulk Saving]**

### 2 Press /▶ to select the 6K/4K photo burst files and press **[MENU/SET]**.

- If the burst time is 5 seconds or less, all frames will be saved as pictures.

### 3 Select the first frame of the pictures to be saved at once.

- Select the frame in the same way as you select pictures from a 6K/4K burst file.
- Pictures will be saved as a group of Burst Mode pictures in JPEG format.

## Correcting 6K/4K Photos After Recording (Post-Recording Refinement)

### ■ Correcting distortion in pictures ([Reduce Rolling Shutter])

The camera corrects distortion in pictures caused by the electronic shutter (rolling shutter effect) when you save them.

#### 1 On the save confirmation screen in step 4 on P50, touch **[Reduce Rolling Shutter]**.

- Return to the confirmation screen if it cannot produce any correction result.

#### 2 Check the correction result, and touch **[Save]**.

- You can check corrected/uncorrected versions of the picture by touching **[Set/Cancel]**.
- The angle of view of the corrected picture may become narrower.
- Depending on the movement of subjects on the edges of the frame, the corrected picture may look unnatural.

### ■ Reducing the noise produced by high sensitivity ([6K/4K PHOTO Noise Reduction])

When saving pictures, reduce the noise produced during recording by high ISO sensitivity.

**MENU** →  **[Playback]** → **[6K/4K PHOTO Noise Reduction]** → **[AUTO]**

- This function is not applied to pictures saved with [6K/4K PHOTO Bulk Saving].

# Controlling Focus After Recording (Post Focus/Focus Stacking)

Applicable modes:      

The camera can perform Burst recording in the same picture quality as 6K/4K photo recording while automatically shifting the focus to different areas.

After the recording, you can select the desired focus point for the picture to be saved. This function is suited for recording still objects.

- We recommend that you use a tripod when recording images to be used for Focus Stacking.
- Use a UHS Speed Class 3 card.

**1** Set the drive mode dial to .

**2** Select the picture size.

**MENU** →  **[Rec]** → **[Post Focus]**

<b>[6K 18M]</b>	[4:3]: (4992×3744)	[3:2]: (5184×3456)
<b>[4K 8M]*</b>	[4:3]: (3328×2496)	[3:2]: (3504×2336)
	[16:9]: (3840×2160)	[1:1]: (2880×2880)

\* The display can be enlarged using [Ex. Tele Conv.].

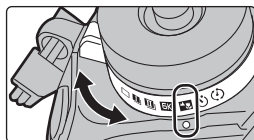

**3** Press the shutter button halfway to exit the menu.

**4** Decide on the composition, and press the shutter button halfway.

- Auto Focus will detect focus areas on the screen. (Excluding the edges of the screen)
- If no areas on the screen can be brought into focus, the focus display (A) will flash. Recording is not possible in this case.



**5** Press the shutter button fully to start recording.

- The focus point changes automatically while recording. When the icon (B) disappears, recording automatically ends.



**From the time you press the shutter button halfway until the end of recording:**

- Maintain the same distance to the subject and the same composition.
- Do not operate the zoom.
- A motion picture will be recorded with [Rec Format] set to [MP4]. (Audio will not be recorded.)
- When [Auto Review] is enabled, a screen that lets you select the desired focus area will be displayed. (P53)

## Selecting the desired focus area and saving a picture

- 1 Select an image with the  icon on the playback screen, and press **▲**.
- 2 Touch the desired focus area.

- If a picture that is in focus is not available for the selected area, a red frame will be displayed. You cannot save a picture in this case.
- You cannot select the edges of the screen.



- Touching  will enlarge the display. You can fine-adjust the focus by dragging the slide bar during enlarged display. (You can also perform the same operation by pressing **◀/▶**.)

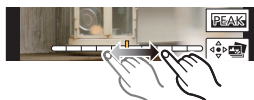

- 3 Touch  to save the picture.

- The picture will be saved in JPEG format.

## Merging multiple pictures to widen the focus range (Focus Stacking)

- 1 Touch  in step 2 of "Selecting the desired focus area and saving a picture".
- 2 Touch the merging method.

<b>[Auto Merging]</b>	Automatically selects pictures that are suited to be merged, and merges them into a single picture. <ul style="list-style-type: none"> <li>• Priority will be given to pictures with closer focus.</li> </ul>
<b>[Range Merging]</b>	Merges pictures with specified focus areas into a single picture.

- 3 (When **[Range Merging]** is selected)  
Touch the desired focus area.

- Specify at least two areas.
- In-focus areas between the two areas will also be selected, and the combined in-focus area will be indicated.
- Grey areas indicate areas that may, if selected, cause the merged picture to look unnatural and areas that cannot be selected.

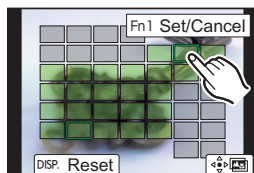
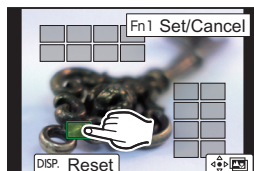

- 4 Touch  to merge the pictures and save the resulting picture.

- The picture will be saved in JPEG format.
- The camera may automatically correct the misalignments of pictures caused by camera shake. If they are corrected, the angle of view becomes slightly narrower when pictures are merged.

# Taking Pictures with Time Lapse Shot/Stop Motion Animation

Applicable modes: **[A]** **[P]** **[A]** **[S]** **[M]**  

You can take pictures with Time Lapse Shot or Stop Motion Animation. In addition, the pictures taken can be combined into a motion picture.

- Set the date and time settings in advance. (P18)
- Recorded pictures are displayed as group pictures.

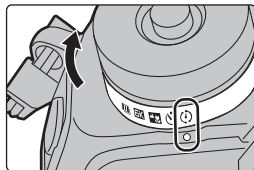

## Taking Pictures Automatically at Set Intervals ([Time Lapse Shot])

The camera can automatically take pictures of subjects such as animals or plants as time elapses and create a motion picture.

- 1 Set the drive mode dial to [  ].
- 2 Select the menu.

**MENU** →  **[Rec]** → **[Time Lapse/Animation]** → **[Mode]** → **[Time Lapse Shot]**

- 3 Press **▲/▼** to select an item and set.

	<b>[Now]</b>	Starts the recording by fully-pressing the shutter button.
<b>[Start Time]</b>	<b>[Start Time Set]</b>	◀/▶: Select the item (hour/minute) ▲/▼: Setting [MENU/SET]: Set
<b>[Shooting Interval]/ [Image Count]</b>		The recording interval and the number of pictures can be set. ◀/▶: Select the item (minute/second/number of pictures) ▲/▼: Setting [MENU/SET]: Set

- 4 Press the shutter button halfway to exit the menu.
- 5 Press the shutter button fully.
  - The recording starts automatically.

## Creating Stop Motion Pictures ([Stop Motion Animation])

A stop motion picture is created by splicing pictures together.

- 1 Set the drive mode dial to [ ⏸ ].
- 2 Select the menu.

**MENU** → [Rec] → [Time Lapse/Animation] → [Mode] → [Stop Motion Animation]

- 3 Press ▲/▼ to select an item and set.

[Auto Shooting]	[ON]	Takes pictures automatically at a set recording interval.
	[OFF]	This is for taking pictures manually, frame by frame.
[Shooting Interval]	(Only when [Auto Shooting] is set to [ON]) ◀▶: Select the item (second) ▲/▼: Setting [MENU/SET]: Set	

- 4 Press the shutter button halfway to exit the menu.
- 5 Press the shutter button fully.
- 6 Move the subject to decide on the composition.

- Repeat recording in the same way.

- 7 Touch to end the recording.

- It can also be ended by selecting [Time Lapse/Animation] from the [Rec] menu and then pressing [MENU/SET].

- When [Auto Shooting] is set to [ON], select [End] on the confirmation screen.

(If [Pause] has been selected, press the shutter button fully to resume the recording.)

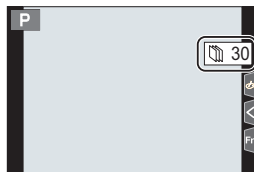

## Creating motion pictures from recorded pictures

To create motion pictures after taking pictures, follow the steps below.

- 1 Select the methods for creating a motion picture.

- The recording format is set to [MP4].

[Rec Quality]	Sets the quality of a motion picture.
[Frame Rate]	Sets the number of frames per second. The larger the number is, the smoother the motion picture will be.
[Sequence]	<b>[NORMAL]:</b> Splices pictures together in recording order. <b>[REVERSE]:</b> Splices pictures together in reverse recording order.

- 2 Press ▲/▼ to select [OK] and then press [MENU/SET].







# Taking Pictures While Adjusting a Setting Automatically (Bracket Recording)



Applicable modes:   **P** **A** **S** **M**  

You can take multiple pictures while automatically adjusting a setting by pressing the shutter button.

## 1 Select the menu.

**MENU** →  **[Rec]** → **[Bracket]** → **[Bracket Type]**

 <b>Exposure Bracket</b>	Press the shutter button to perform recording while adjusting the exposure. (P57) • This is disabled when recording using the flash.
 <b>Aperture Bracket</b>	Press the shutter button to perform recording while adjusting the aperture. (P57) • Available in Aperture-Priority AE Mode or when the ISO sensitivity is set to [AUTO] in Manual Exposure Mode.
FOCUS <b>Focus Bracket</b>	Press the shutter button to perform recording while adjusting the focus position. (P57)
WB  * <b>White Balance Bracket</b>	Press the shutter button once to take three pictures with different white balance settings automatically. (P58)
WB  * <b>White Balance Bracket (Colour Temperature)</b>	Press the shutter button once to take three pictures with different White Balance Colour Temperature values automatically. (P58) • Available when the White Balance is set to [  ], [  ], or [  ].

\* It cannot be selected in Intelligent Auto Plus Mode or Creative Control Mode or when burst recording is enabled or [Quality] is set to [RAW ], [RAW ], or [RAW].

## 2 Press ▲/▼ to select [More Settings] and then press [MENU/SET].

- For information on [More Settings], refer to the page that describes each function.
- Press the shutter button halfway to exit the menu.

## 3 Focus on the subject and take a picture.

### ■ To deactivate Bracket

Select [OFF] in step 1.



## Exposure Bracket

### ■ About [More Settings] (step 2 in P56)

<b>[Step]</b>	Sets the number of pictures to be taken and the exposure compensation range. [3•1/3] (Takes three pictures with an interval of 1/3 EV) to [7•1] (Takes seven pictures with an interval of 1 EV)
<b>[Sequence]</b>	Sets the order in which pictures are taken.
<b>[Single Shot Setting]*</b>	[□]: Takes one picture each time you press the shutter button. [☐]: Takes all the pictures set to be taken when you press the shutter button once.

- \* Not available for burst recording. When using burst recording, if you press and hold the shutter button, recording will be performed continuously until a specified number of pictures are taken.

## Aperture Bracket

Recording Mode: **A** **M**

### ■ About [More Settings] (step 2 in P56)

<b>[Image Count]</b>	[3], [5]: Takes a specified number of pictures with different aperture values within the range based on the initial aperture value. [ALL]: Takes pictures using all aperture values.
----------------------	---

- When using burst recording, if you press and hold the shutter button, recording will be performed until a specified number of pictures are taken.
- The available aperture values vary depending on the lens.

## Focus Bracket

### ■ About [More Settings] (step 2 in P56)

<b>[Step]</b>	Sets the interval between focus positions.
<b>[Image Count]*</b>	Sets the number of pictures to be taken.
<b>[Sequence]</b>	[0/–/+]: Alternately moves the focus position closer and farther away within the range centred on the initial position as you take pictures. [0/+]: Moves the focus position farther away from the initial position as you take pictures.

- \* Not available for burst recording. When using burst recording, if you press and hold the shutter button, recording will be performed continuously until a specified number of pictures are taken.
- Pictures taken with Focus Bracket are displayed as a set of group pictures.





## White Balance Bracket

### ■ About [More Settings] (step 2 in P56)

Rotate the control dial to adjust the correction range, and press [MENU/SET].

 : Horizontal ([A] to [B])

 : Vertical ([G] to [M])

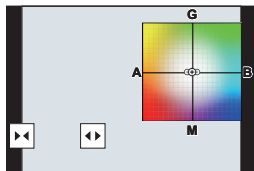

- You can also set the correction range by touching []/[]/[]/[].



## White Balance Bracket (Colour Temperature)



### ■ About [More Settings] (step 2 in P56)

Rotate the control dial to adjust the correction range, and press [MENU/SET].

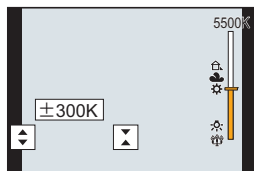















- You can also set the correction range by touching []/[].



# Image Stabiliser

The camera can activate either the In-Lens Image Stabiliser or In-Body Image Stabiliser, or it can activate both of them and reduce jitter even more effectively. (Dual I.S. Mode) Dual I.S.2 (  /  /  ), which provides more effective correction, is also supported.

- The image stabilisers to be activated differ depending on your lens. The icon for the currently activated image stabiliser is displayed on the recording screen.

	When taking pictures	When recording motion pictures
<b>Panasonic lenses compatible with Dual I.S. Mode</b> <b>(Based on the Micro Four Thirds System standard)</b> <ul style="list-style-type: none"> <li>• For the latest information on compatible lenses, please refer to our website.</li> <li>• If the [DUAL2] or [DUAL] icon is not displayed on the recording screen even when a compatible lens is used, update the lens firmware to the latest version. (P9)</li> </ul>	<b>Lens + Body (Dual I.S.)</b> (  /  /  /  )	<b>Lens + Body (Dual I.S.)</b> (  /  ), <b>5-Axis Hybrid</b> (  /  )*
<b>Lenses compatible with the image stabiliser function</b> <b>(Based on the Micro Four Thirds System standard/Four Thirds System standard)</b>	<b>Lens or Body</b> (  /  )	<b>Lens or Body</b> (  ), <b>5-Axis Hybrid</b> (  )*
<b>Lenses not compatible with the image stabiliser function</b> <b>(Based on the Micro Four Thirds System standard/Four Thirds System standard)</b>	<b>Body</b> (  /  )	<b>Body</b> (  ), <b>5-Axis Hybrid</b> (  )*
<b>When using a Leica lens mount adaptor (optional) or mount adaptor made by another manufacturer</b>		(  )*





\* When [E-Stabilization (Video)] in [Stabilizer] in the [Rec] menu is set to [ON].

**Applicable modes:**   **P** **A** **S** **M**  

- When using an interchangeable lens with O.I.S. switch (such as H-ES12060), stabiliser function is activated if the O.I.S. switch of the lens is set to [ON]. (  ) is set at the time of purchase)

## Select the menu.

**MENU** →  **[Rec]** → **[Stabilizer]**

<b>[Operation Mode]</b>	 (Normal)	Camera shake is corrected for up/down, left/right, and rotational movements.
	 (Panning)	Camera shake is corrected for up/down movements. This mode is ideal for panning (a method of taking pictures which involves turning the camera to track the movements of a subject which continues to move in a fixed direction).
	<b>[OFF]</b>	[Stabilizer] does not work.  <ul style="list-style-type: none"> <li>When using a lens with an O.I.S. switch, set the switch to [OFF].</li> </ul>
<b>[E-Stabilization (Video)]</b>	Jitter during motion picture recording is corrected along the vertical, horizontal, roll, pitch, and yaw axes by making use of the In-Lens Image Stabiliser, In-Body Image Stabiliser, and Electronic Image Stabiliser. (5-Axis Hybrid Image Stabiliser) <b>[ON]/[OFF]</b> <ul style="list-style-type: none"> <li>When [ON] is selected, the angle of view of recorded motion pictures may become narrower.</li> </ul>	
<b>[I.S. Lock (Video)]</b>	Allows you to enhance the image stabilisation effect during motion picture recording. <b>[ON]/[OFF]</b> <ul style="list-style-type: none"> <li>This effect works only during recording.  is displayed on the recording screen.</li> <li><b>To change the composition during recording, set the effect to [OFF] first, and then move the camera.</b> Use the appropriate function button to change the setting during recording. (P30)</li> </ul>	
<b>[Focal Length Set]</b>	If the focal length is not set automatically, you can set it manually. <ul style="list-style-type: none"> <li>When a manually selected focal length is set, a confirmation screen asking you to change the focal length setting is displayed after you turn on the camera.</li> </ul>	

### Setting the focal length of a lens

#### 1 Select the menu.

**MENU** →  **[Rec]** → **[Stabilizer]** → **[Focal Length Set]**

#### 2 Enter a focal length.

◀/▶: Select the item (digit); ▲/▼: Setting

#### 3 Press [MENU/SET].

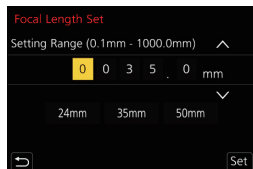

# Raising the telescopic effect

Applicable modes:

Extra Tele Conversion enables you to take pictures that are further enlarged without deteriorating the picture quality.

When taking pictures	[Ex. Tele Conv.] ([Rec])	1.4×: [EX M] 2.0×: [EX S] 1.4×: When recording 6K/4K photos* ([16:9]/[1:1]) 1.5×: When recording 6K/4K photos* ([3:2]) 1.6×: When recording 6K/4K photos* ([4:3]) * Only when [4K H 8M], [4K 8M] is set
----------------------	-----------------------------	--

- Set the picture size to [M] or [S] (picture sizes indicated with [EX]), and set the quality to [ ] or [ ].

When recording motion pictures	[Ex. Tele Conv.] ([Motion Picture])	1.4× (motion pictures size is set to [4K] in [Rec Quality]) 2.7× (motion pictures size is set to [FHD] in [Rec Quality])
--------------------------------	--	---

## ■ Increasing the zoom magnification in steps

- This can be used only when recording pictures.

### 1 Select the menu.

**MENU** → [Rec] → [Ex. Tele Conv.] → [ZOOM]

### 2 Set a function button to [Zoom Control]. (P30)

### 3 Press the function button.

### 4 Press or .

: Tele (Enlarges distant subject)

: Wide (Widens angle of view)

- The zoom operation is terminated when the function button is pressed again or a certain amount of time passes.

## ■ Fixing the zoom magnification at the maximum level

Select the menu.

**MENU** → [Rec] → [Ex. Tele Conv.] → [TELE CONV.]

**MENU** → [Motion Picture] → [Ex. Tele Conv.] → [ON]

# Taking Pictures with the External Flash (Optional)

**Applicable modes:**

You can attach a flash (DMW-FL580L/DMW-FL360L/DMW-FL200L: optional) and take pictures with it.

• Read the operating instructions of the external flash for how to attach the external flash.

## ■ Removing the Hot Shoe Cover

The camera comes with a hot shoe cover attached to the hot shoe.

Remove the hot shoe cover by pulling it in the direction indicated by arrow ② while pressing it in the direction indicated by arrow ①.

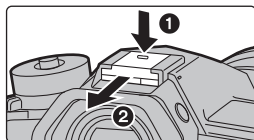

In the following cases, the flash is fixed to [☹] (forced flash off).

- When recording motion pictures
- When recording in Burst Mode (only when burst setting is set to [SH2]/[SH1]/[SH2 PRE]/[SH1 PRE])
- When recording 6K/4K photos
- When recording with the Post Focus function
- When using the electronic shutter
- When an image effect in [Filter Effect] of [Filter Settings] is set
- When [Silent Mode] is set to [ON]
- When [High Resolution Mode] is set
- When [HDR] is set to [ON]

## Changing Flash Mode

**Applicable modes:**

Set the flash to match the recording.

Select the menu.

**MENU** → [Rec] → [Flash] → [Flash Mode]

((Forced Flash On)) ((Forced On/Red-Eye))	The flash is activated every time regardless of the recording conditions. <b>• Use this when your subject is back-lit or under fluorescent light.</b>
((Slow Sync.)) (([Slow Sync./Red-Eye]))	When taking pictures against a dark background landscape, this feature will slow the shutter speed when the flash is activated. Dark background landscape will appear brighter. <b>• Use this when you take pictures of people in front of a dark background.</b> <b>• Using a slower speed can cause motion blur. Using a tripod can enhance your photos.</b>
((Forced Flash Off))	The flash is not activated in any recording conditions. <b>• Use this when you take pictures in places where the use of flash is not permitted.</b>

# Recording Motion Picture

Applicable modes:   **P** **A** **S** **M**  

This camera can record full high definition motion pictures compatible with the AVCHD format or motion pictures recorded in MP4.

In addition, the camera can record 4K motion pictures in MP4.

Audio will be recorded in stereo.

## 1 Start recording by pressing the motion picture button.

- (A) Elapsed recording time
- (B) Available recording time

- Recording of motion picture appropriate for each mode is possible.
- The recording state indicator (red) (C) will flash while recording motion pictures.
- Release the motion picture button right after you press it.
- m: minute, s: second

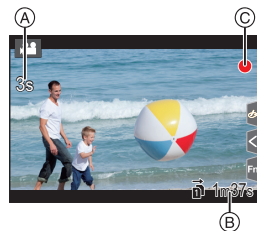
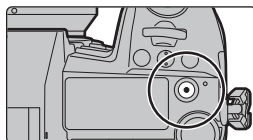

## 2 Stop the recording by pressing the motion picture button again.

- Still picture recording is also possible during the motion picture recording by fully pressing the shutter button. (Except for in Creative Video Mode)
- In Creative Video Mode, motion pictures are recorded at the selected ISO sensitivity; in other modes, they are recorded using [AUTO] (for motion pictures).

- When the ambient temperature is high or motion picture is recorded continuously, the camera may display [△] and stop the recording to protect itself. Wait until the camera cools down.
- Continuous motion picture recordable times**

[Rec Format]	[Rec Quality]	Continuous recordable time	Size interval for dividing files
[AVCHD]	All	29 minutes and 59 seconds	Files exceeding 4 GB in size will be divided into smaller files for recording.*
[MP4]	FHD		Files exceeding 4 GB in size will be divided into smaller files for recording and playback.*
	[4K/100M/30p] [4K/100M/25p] [4K/100M/24p]	10 minutes	<b>When an SDHC card is used:</b> Files exceeding 4 GB in size will be divided into smaller files for recording and playback.*
	[4K/150M/60p] [4K/150M/50p]		<b>When an SDXC card is used:</b> Files are not divided for recording.

\* You can continue recording without interruption.

### ■ Setting the format, size and recording frame rate

**MENU** →  [Motion Picture] → [Rec Format]

[AVCHD]	This data format is suitable for when playing back on a high-definition TV, etc.
[MP4]	This data format is suitable for when playing back on a PC, etc.

**MENU** →  [Motion Picture] → [Rec Quality]

### When [AVCHD] is selected

Item	Size	Recording frame rate	Sensor output	Bit rate
[FHD/28M/50p] <sup>*1</sup>	1920×1080	50p	50 frames/second	28 Mbps
[FHD/17M/50i]	1920×1080	50i	50 frames/second	17 Mbps
[FHD/24M/25p]	1920×1080	50i	25 frames/second	24 Mbps

\*1 AVCHD Progressive



## When [MP4] is selected

Item	Size	Recording frame rate	Sensor output	Bit rate
[4K/150M/60p] <sup>*2</sup>	3840×2160	60p	60 frames/second	150 Mbps
[4K/150M/50p] <sup>*2</sup>	3840×2160	50p	50 frames/second	150 Mbps
[4K/100M/30p]	3840×2160	30p	30 frames/second	100 Mbps
[4K/100M/25p]	3840×2160	25p	25 frames/second	100 Mbps
[4K/100M/24p]	3840×2160	24p	24 frames/second	100 Mbps
[FHD/28M/60p]	1920×1080	60p	60 frames/second	28 Mbps
[FHD/28M/50p]	1920×1080	50p	50 frames/second	28 Mbps
[FHD/20M/30p]	1920×1080	30p	30 frames/second	20 Mbps
[FHD/20M/25p]	1920×1080	25p	25 frames/second	20 Mbps

\*2 These items are intended for motion picture editing on a computer. Playback and editing on a device other than this camera require a high-performance PC environment.

- All motion pictures will be recorded in 4:2:0/8 bit Long GOP format.

## How to set focus when recording a motion picture ([Continuous AF])

Applicable modes:   **P** **A** **S** **M**  

Focusing changes depending on the Focus Mode setting and the [Continuous AF] setting in the [Motion Picture] menu.

Focus mode	[Continuous AF]	Description of settings
[AFS]/[AFF]/ [AFC]	[ON]	The camera automatically keeps focusing on subjects during recording.
	[OFF]	The camera maintains the focus position at the start of recording.
[MF]	[ON]/[OFF]	You can focus manually.

# Recording Motion Pictures in Creative Video Mode

Recording Mode: 

It is possible to manually change the aperture, shutter speed and ISO sensitivity and record motion pictures.

- 1 Set the mode dial to .
- 2 Select the menu.

**MENU** →  **[Creative Video]** → **[Exposure Mode]** → **[P]/[A]/[S]/[M]**

- The operation for changing the aperture value or shutter speed is the same as the operation for setting the mode dial to **P**, **A**, **S** or **M**.

- 3 Press the motion picture button (or shutter button) to start recording.

- The operational sound of the zoom or button operation may be recorded when it is operated during the recording of a motion picture.

Using touch icons allows silent operation while recording motion pictures.

- 1 Touch .
- 2 Touch icon.

 : Zoom

**F** : Aperture value

**SS** : Shutter speed

 : Exposure Compensation

**ISO** : ISO sensitivity

 : Mic level adjustment

- 3 Drag the slide bar to set.

 : Changes the setting slowly

 : Changes the setting quickly

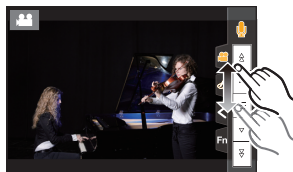

- 4 Press the motion picture button (or shutter button) again to stop recording.

- With Creative Video Mode, you can set an ISO sensitivity value that falls in the range below.
  - [AUTO], [200] to [12800] ([100] to [12800] if [Extended ISO] is set)
  - Upper limit of the [AUTO] ISO sensitivity: [6400] (When the [ISO Auto Upper Limit Setting] [ISO Sensitivity (video)] is set to [AUTO])

## Recording slow motion pictures (High Speed Video)

You can record slow motion pictures by performing ultra-high-speed recording.

- Use a UHS Speed Class 3 card.

- 1 Set the mode dial to [M].
- 2 Select the menu.

**MENU** → **[Creative Video]** → **[High Speed Video]**

Settings	Frame rate (for recording)	[Rec Quality] (for storage)	Slow motion effect
[180fps/FHD]	180 frames/second	FHD/20M/30p	Approx. 1/6×
[150fps/FHD]	150 frames/second	FHD/20M/25p	Approx. 1/6×
[60fps/4K]	60 frames/second	4K/100M/30p	Approx. 1/2×
[50fps/4K]	50 frames/second	4K/100M/25p	Approx. 1/2×
[48fps/4K]	48 frames/second	4K/100M/24p	Approx. 1/2×
[OFF]	—		

- The recording format is set to [MP4].

- 3 Press the motion picture button (or shutter button) to start recording.
- 4 Press the motion picture button (or shutter button) again to stop recording.

- Auto Focus does not work.
- Audio is not recorded.
- When using an interchangeable lens with no focus ring, you cannot set focus with Manual Focus.
- Under fluorescent lighting, flicker or horizontal bars may be seen.

## Recording Motion Pictures that Pan and Zoom While Maintaining a Fixed Camera Position ([4K Live Cropping])

By cropping your motion picture down from the 4K angle of view to Full High Definition, you can record a motion picture that pans and zooms in/out while leaving the camera in a fixed position.

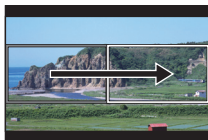

Pan

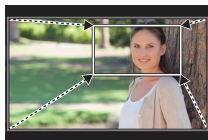

Zoom in

- [Rec Format] and [Rec Quality] in the [Motion Picture] menu will be fixed to [MP4] and [FHD/20M/30p]/[FHD/20M/25p], respectively.
- Hold the camera firmly in place while recording.

- 1 Set the mode dial to [M].
- 2 Select the menu.

**MENU** → **MM [Creative Video]** → **[4K Live Cropping]** → **[40SEC]/[20SEC]**

### 3 Set the cropping start frame.

#### Ⓐ Cropping start frame

- When making settings for the first time, a cropping start frame of size 1920×1080 is displayed. (After setting the cropping start frame and end frame, the start frame and end frame that you set immediately before will be displayed.)
- The camera will remember the frame position and size even when the camera is turned off.

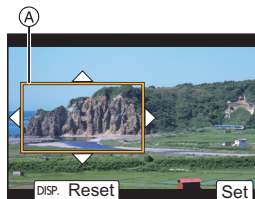

Button operation	Touch operation	Description of operation
▲/▼/◀/▶	Touching	Moves the frame.
	Pinching out/in	Enlarges/reduces the frame.
[DISP.]	[Reset]	Returns the position of the frame to the centre and its size to the default setting.
[MENU/SET]	[Set]	Decides the position and size of the frame.

### 4 Repeat step 3, and then set the cropping end frame.

#### Ⓑ Cropping end frame

- The setting of the Auto Focus Mode switches to [AF]. (Human eyes and bodies cannot be detected. In addition, you cannot specify the person to be brought into focus.)

### 5 Press the motion picture button (or shutter button) to start recording.

- Immediately release the motion picture button (or the shutter button) after pressing it.
- When the set operating time has elapsed, recording automatically ends.  
To end recording midway, press the motion picture button (or the shutter button) again.

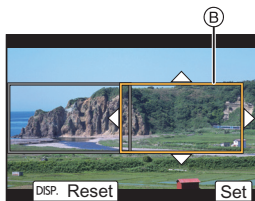

### ■ Changing the position and size of a crop frame

Press ◀ while the recording screen is displayed, and perform steps 3 and 4.

## Playing Back Pictures

**1** Press [▶].

**2** Press ◀/▶.

◀: Play back the previous picture

▶: Play back the next picture

(A) Card slot

- If you press and hold ◀/▶, you can play back the pictures in succession.

- You can switch the card selected for playback by forwarding/rewinding pictures continuously.

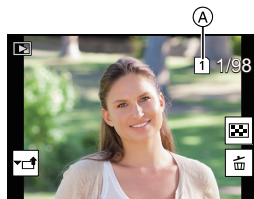
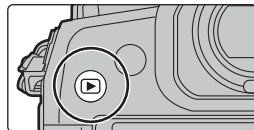

### Switching the card selected for playback instantly

You can switch the card selected for playback instantly by assigning [Slot Change] to a function button.

#### ■ To finish playback

Press [▶] again or press the shutter button halfway.

## Playing Back Motion Pictures

This unit was designed to play motion pictures using the AVCHD and MP4 formats.

- Motion pictures are displayed with the motion picture icon ((👤👤)).

#### Press ▲ to play back.

(A) Motion picture recording time



#### ■ Operations during Motion Picture Playback

Button operation	Touch operation	Description of operation	Button operation	Touch operation	Description of operation
▲	▶/	Play/Pause	▼	■	Stop
◀	◀◀	Fast rewind <sup>*1</sup>	▶	▶▶	Fast forward <sup>*1</sup>
	◀	Frame-by-frame rewind (while pausing) <sup>*2</sup>		▶	Frame-by-frame forward (while pausing)
(⚙️)	−	Reduce volume level	(⚙️)	+	Increase volume level

\*1 The fast forward/rewind speed increases if you press ▶/◀ again.

\*2 When a motion picture recorded with [AVCHD] is rewound frame-by-frame, its frames will be shown in intervals of approximately 0.5 seconds.

# Switching the Playback Method

## Using the Playback Zoom

### Rotate the rear dial right.

1× → 2× → 4× → 8× → 16×



Button operation	Touch operation	Description of operation
	—	Enlarges/reduces the screen in large steps.
—	Pinching out/in	Enlarges/reduces the screen in small steps.
	Dragging	Moves the enlarged area (during enlarged display).
	—	Forwards or rewinds the image while maintaining the same zoom magnification and zoom position. (During Playback Zoom)

- Each time you touch the screen twice, the display switches between enlarged and normal view.

## Displaying multiple screens (Multi Playback)

### Rotate the rear dial left.

1 screen → 12 screens → 30 screens → Calendar screen display

(A) Card slot

- Playback is performed separately by card slot. You can switch the card selected for playback by pressing [Fn1]. (Except for when the Calendar screen is displayed)
- If the rear dial is rotated to the right, the previous playback screen will be displayed.



### ■ To return to Normal Playback

Press ▲/▼/◀/▶ to select a picture and then press [MENU/SET].

- If you select a motion picture, it will be played back automatically.

## Displaying Pictures by Recording Date (Calendar Playback)

**1 Rotate the rear dial left to display the Calendar screen.**

**2 Press ▲/▼/◀/▶ to select the recording date and press [MENU/SET].**

- Only the images recorded on that date will be displayed.
- Rotate the rear dial left to return to the Calendar screen display.

**3 Press ▲/▼/◀/▶ to select a picture and then press [MENU/SET].**



- Playback is performed separately by card slot. You cannot switch the card selected for playback while the Calendar is displayed.

## Playing Back Group Pictures

A picture group consists of multiple pictures. You can play back pictures in a group either continuously or one by one.

- You can edit or delete all pictures in a group at once.

[]:

A picture group consisting of pictures taken in the Burst Mode with the burst speed [SH2], [SH1], [SH2 PRE] or [SH1 PRE].

A picture group saved at once with [6K/4K PHOTO Bulk Saving].

[]:

A picture group consisting of pictures taken with Focus Bracket.

[]:

A picture group consisting of pictures taken in a Time Lapse Shot.

[]:

A picture group consisting of pictures taken in the Stop Motion Animation.

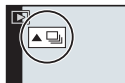

### ■ Continuously playing back Group Pictures

Press ▲.

### ■ Playing back group pictures one by one

**1 Press ▼.**

**2 Press ◀/▶ to flip through images.**

- Pressing ▼ again will return you to the normal playback screen.
- Each picture in a group can be treated same as normal pictures when they are played back.

# Deleting Pictures

Once deleted, pictures cannot be recovered.

## ■ To delete a single picture

- 1 In Playback Mode, select the picture to delete and then press [  ].

- The same operation can be performed by touching [  ].

- 2 Press ▲ to select [Delete Single] and then press [MENU/SET].

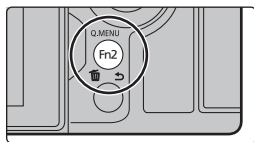

## ■ To delete multiple pictures (up to 100) or all the pictures

- Picture groups are treated as a single picture. (All the pictures in the selected picture group will be deleted.)
- You can only delete images on one card at a time.

- 1 In Playback Mode, press [  ].

- 2 Press ▲/▼ to select [Delete Multi] or [Delete All] and then press [MENU/SET].

- If you select [Delete All], all the pictures on the card of the displayed icon will be deleted.

- 3 (When [Delete Multi] is selected)

Press ▲/▼/◀/▶ to select the picture, and then press [MENU/SET] to set. (Repeat this step.)

- [  ] appears on the selected pictures.

If [MENU/SET] is pressed again, the setting is cancelled.

- Pictures are displayed separately by card slot. You can switch the displayed card by pressing [Fn1].

- 4 (When [Delete Multi] is selected)

Press [DISP.] to execute.



# Menu list



**To display explanations of the menu items.**

If you press [DISP.] while a menu item or setting is selected, a description of the menu is displayed.



## Menus that are only available for particular Recording Modes

The following menus are displayed only for their corresponding Recording Modes:



### [Intelligent Auto]

[Intelligent Auto Mode]

[iHandheld Night Shot]

[iHDR]



### [Creative Video]

[Exposure Mode]

[High Speed Video]

[4K Live Cropping]



### [Custom Mode]

You can change the settings registered to custom sets (C3). (P24)



### [Creative Control]

[Filter Effect]

[Simultaneous Record w/o Filter]



### [Rec]

[Aspect Ratio]

[Flash]

[6K/4K PHOTO]

[Picture Size]

[Red-Eye Removal]

[Post Focus]

[Quality]

[ISO Sensitivity (photo)]

[Self Timer]

[AFS/AFF]

[Min. Shtr Speed]

[High Resolution Mode]

[AF Custom Setting(Photo)]

[Long Shtr NR]

[Time Lapse/Animation]

[Photo Style]

[Shading Comp.]

[Silent Mode]

[Filter Settings]

[Diffraction Compensation]

[Shutter Type]

[Color Space]

[Stabilizer]

[Shutter Delay]

[Metering Mode]

[Ex. Tele Conv.]

[Bracket]

[Highlight Shadow]

[Digital Zoom]

[HDR]

[i.Dynamic]

[Burst Shot 1 Setting]

[Multi Exp.]

[i.Resolution]

[Burst Shot 2 Setting]

[Time Stamp Rec]

**[Motion Picture]**

[Rec Format]	[i.Resolution]	[Mic Level Disp.]
[Rec Quality]	[ISO Sensitivity (video)]	[Mic Level Adj.]
[AFS/AFF]	[Shading Comp.]	[Mic Level Limiter]
[Continuous AF]	[Diffraction Compensation]	[Wind Noise Canceller/ Wind Cut]
[Photo Style]	[Stabilizer]	[Lens Noise Cut]
[Filter Settings]	[Flkr Decrease]	[Special Mic.]
[Luminance Level]	[Ex. Tele Conv.]	[Sound Output]
[Metering Mode]	[Digital Zoom]	
[Highlight Shadow]	[Picture Mode in Rec.]	
[i.Dynamic]	[Time Stamp Rec]	

**[Custom]**

<b>[Exposure]</b>	[AF+MF]	[Histogram]
[ISO Increments]	[MF Assist]	[Guide Line]
[Extended ISO]	[MF Assist Display]	[Center Marker]
[Exposure Comp. Reset]		[Highlight]
	<b>[Operation]</b>	[Zebra Pattern]
<b>[Focus / Release Shutter]</b>	[Fn Button Set]	[Expo.Meter]
[AF/AE Lock]	[Fn Lever Setting]	[MF Guide]
[AF/AE Lock Hold]	[Q.MENU]	[LVF/Monitor Disp. Set]
[Shutter AF]	[Dial Set.]	[Monitor Info. Disp.]
[Half Press Release]	[Joystick Setting]	[Rec Area]
[Quick AF]	[Operation Lock Setting]	[Remaining Disp.]
[Eye Sensor AF]	[Video Button]	[Menu Guide]
[Pinpoint AF Setting]	[Touch Settings]	
[AF-Point Scope Setting]		<b>[Lens / Others]</b>
[AF Assist Lamp]	<b>[Monitor / Display]</b>	[Lens Position Resume]
[Focus/Release Priority]	[Auto Review]	[Power Zoom Lens]
[Focus Switching for Vert / Hor]	[Monochrome Live View]	[Lens Fn Button Setting]
[Loop Movement Focus Frame]	[Constant Preview]	[Face Recog.]
[AF Area Display]	[Peaking]	[Profile Setup]

**[Setup]**

[Online Manual]	[LVF Display Speed]	[Version Disp.]
[Cust.Set Mem.]	[Night Mode]	[Folder / File Settings]
[Clock Set]	[Monitor Display]/ [Viewfinder]	[Double Slot Function]
[World Time]		[Save/Restore Camera Setting]
[Travel Date]	[Monitor Luminance]	[No.Reset]
[Wi-Fi]	[Status-LCD Backlight]	[Reset]
[Bluetooth]	[Eye Sensor]	[Reset Network Settings]
[Wireless Connection Lamp]	[Battery Use Priority]	[Pixel Refresh]
[Beep]	[USB Mode]	[Sensor Cleaning]
[Headphone Volume]	[USB Power Supply]	[Level Gauge Adjust.]
[Economy]	[TV Connection]	[Format]
[Monitor Display Speed]	[Language]	

**[My Menu]**

[My Menu Setting]

**[Playback]**

[Slide Show]	[6K/4K PHOTO Noise Reduction]	[Video Divide]
[Playback Mode]	[Light Composition]	[Time Lapse Video]
[Protect]	[Clear Retouch]	[Stop Motion Video]
[Rating]	[Text Stamp]	[Rotate Disp.]
[Title Edit]	[Copy]	[Picture Sort]
[Face Rec Edit]	[Resize]	[Delete Confirmation]
[RAW Processing]	[Cropping]	
[6K/4K PHOTO Bulk Saving]	[Rotate]	

**[Aspect Ratio]**
**Applicable modes:** **P** **A** **S** **M**

This allows you to select the aspect ratio of the pictures to suit printing or the playback method.

**MENU** → **[Rec]** → **[Aspect Ratio]**

<b>[4:3]</b>	[Aspect Ratio] of a 4:3 TV
<b>[3:2]</b>	[Aspect Ratio] of a 35 mm film camera
<b>[16:9]</b>	[Aspect Ratio] of a 16:9 TV
<b>[1:1]</b>	Square aspect ratio

**[Picture Size]**

Applicable modes:

Set the number of pixels.

The higher the numbers of pixels, the finer the detail of the pictures will appear even when they are printed onto large sheets.

**MENU** → **[Rec]** → **[Picture Size]**

When the aspect ratio is [4:3].

Settings	Image size
[L] (20M)	5184×3888
[EXM] (10M)	3712×2784
[EXS] (5M)	2624×1968

When the aspect ratio is [16:9].

Settings	Image size
[L] (14.5M)	5184×2920
[EXM] (8M)	3840×2160
[EXS] (2M)	1920×1080

When the aspect ratio is [3:2].

Settings	Image size
[L] (17M)	5184×3456
[EXM] (9M)	3712×2480
[EXS] (4.5M)	2624×1752

When the aspect ratio is [1:1].

Settings	Image size
[L] (14.5M)	3888×3888
[EXM] (7.5M)	2784×2784
[EXS] (3.5M)	1968×1968

**[Quality]**

Applicable modes:

Set the compression rate at which the pictures are to be stored.

**MENU** → **[Rec]** → **[Quality]**

Settings	File format	Description of settings
[]	JPEG	A JPEG image in which image quality was given priority.
[]		A standard image quality JPEG image. This is useful for increasing the number of shots without changing the number of pixels.
[RAW]	RAW+JPEG	You can record a RAW image and a JPEG image ([] or []) simultaneously.
[RAW]		
[RAW]	RAW	You can only record RAW images.













- RAW images are always recorded in the [4:3] (5184×3888) aspect ratio.
- When you delete an image recorded with [RAW] or [RAW], both the RAW and JPEG images will be deleted simultaneously.
- When you play back an image recorded with [RAW], grey areas corresponding to the aspect ratio at the time of recording are displayed.
- This item is not available when [High Resolution Mode] is set.
- You can process RAW images in [RAW Processing] in the [Playback] menu. (P86)
- Use software ("SILKYPIX Developer Studio" (P101) by Ichikawa Soft Laboratory) to process and edit RAW files on a PC.

## [Photo Style]

Applicable modes:   **P** **A** **S** **M** 

You can select effects to match the type of image you wish to record.

**MENU** →  **[Rec]** → **[Photo Style]**

 <b>STD. [Standard]</b>	This is the standard setting.
 <b>VIVID [Vivid]</b>	Brilliant effect with high saturation and contrast.
 <b>NAT [Natural]</b>	Soft effect with low contrast.
 <b>MONO [Monochrome]</b>	Monochrome effect with no colour shades.
 <b>L.MONO [L.Monochrome]</b>	Black-and-white effect with rich gradation and crisp black accents.
 <b>SCNY [Scenery]</b>	An effect appropriate for sceneries with vivid blue skies and greens.
 <b>PORT [Portrait]</b>	An effect appropriate for portraits with a healthy and beautiful skin tone.
 <b>CUST 1 [Custom1]</b>	Use the setting registered in advance.
 <b>CUST 2 [Custom2]</b>	
 <b>CUST 3 [Custom3]</b>	
 <b>CUST 4 [Custom4]</b>	
 <b>CINED [Cinelike D]</b>	Gives priority to the dynamic range by using a gamma curve designed to create film-like images. Suited for editing.
 <b>CNEV [Cinelike V]</b>	Gives priority to the contrast by using a gamma curve designed to create film-like images.

## ■ Adjusting the picture quality

- 1 Press ◀/▶ to select the type of Photo Style.
- 2 Press ▲/▼ to select the items, and then press ◀/▶ to adjust.

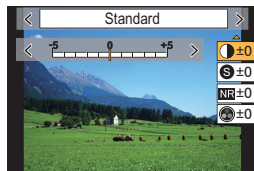

● [Contrast]	[+]	Increases the difference between the brightness and the darkness in the picture.
	[-]	Decreases the difference between the brightness and the darkness in the picture.
● [Sharpness]	[+]	The picture is sharply defined.
	[-]	The picture is softly focused.
NR [Noise Reduction]	[+]	The noise reduction effect is enhanced. Picture resolution may deteriorate slightly.
	[-]	The noise reduction effect is reduced. You can obtain pictures with higher resolution.
● [Saturation] <sup>*1</sup>	[+]	The colours in the picture become vivid.
	[-]	The colours in the picture become natural.
● [Color Tone] <sup>*1</sup>	[+]	Adds a bluish tone.
	[-]	Adds a yellowish tone.
● [Filter Effect] <sup>*2</sup>	[Yellow]	Enhances the contrast of an subject. (Effect: Weak) The blue sky can be recorded clearly.
	[Orange]	Enhances the contrast of an subject. (Effect: Medium) The blue sky can be recorded in darker blue.
	[Red]	Enhances the contrast of an subject. (Effect: Strong) The blue sky can be recorded in much darker blue.
	[Green]	The skin and lips of people appear in natural tones. Green leaves appear brighter and more enhanced.
	[Off]	—

\*1 [Color Tone] is displayed only when [Monochrome] or [L.Monochrome] is selected. In other cases, [Saturation] will be displayed.

\*2 Displayed only when [Monochrome] or [L.Monochrome] is selected.

• If you adjust the picture quality, [+] is displayed beside the Photo Style icon on the screen.

- 3 Press [MENU/SET].

## ■ Registering settings to [Custom1] to [Custom4]

- 1 Adjust the picture quality following step 2 of “Adjusting the picture quality”, and then press [DISP].
- 2 Press ▲/▼ to select a destination to which the setting will be registered, and press [MENU/SET].

## [Metering Mode]

Applicable modes: **P** **A** **S** **M**

Type of optical measurement to measure brightness can be changed.

**MENU** → **[Rec]** → **[Metering Mode]**

<b>[☉]</b> (Multiple)	This is the method in which the camera measures the most suitable exposure by judging the allocation of brightness on the whole screen automatically. Usually, we recommend using this method.
<b>[☐]</b> (Centre weighted)	This is the method used to focus on the subject on the centre of the screen and measure the whole screen evenly.
<b>[□]</b> (Spot)	This is the method to measure the subject in the spot metering target. • If you set the spot metering target on the edge of the screen, the metering may be affected by the brightness around the location.

## [High Resolution Mode]

Applicable modes: **P** **A** **S** **M**

This function generates a picture with enhanced resolution from pre-recorded images. It is effective for still subjects.

• **Use a tripod to minimise camera shake.**

- If you are using a Panasonic interchangeable lens, its image stabiliser function will be automatically set to [OFF]. When using a non-Panasonic interchangeable lens provided with an image stabiliser function that can be turned ON/OFF, set it to OFF.

**MENU** → **[Rec]** → **[High Resolution Mode]**

**1 Press ▲/▼ to select [Start], and press [MENU/SET].**

- The High-Res Mode icon **(A)** will flash when shake is detected. It may not be possible to create pictures with the impression of high resolution. To avoid this, hold the camera firmly.

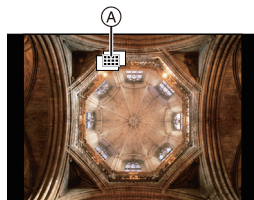

**2 Decide on the composition, and perform recording.**

- The screen will go dark during recording.
- The recording state indicator (red) **(B)** will flash. Do not move the camera while the indicator is flashing.
- Recording will finish automatically. When the recording has finished, the camera will combine the pictures, so it will not be able to perform the next recording for a while.
- You can proceed to the next recording.



**3 Press [Fn2] to end High-Res Mode.**

## ■ Changing the setup

<b>[Picture Size]</b>	<p>Sets the picture size.</p> <p><b>When the aspect ratio is [4:3].</b>      <b>When the aspect ratio is [16:9].</b></p> <p><b>[XL] (80.5M):</b> 10368×7776      <b>[XL] (60.5M):</b> 10368×5832</p> <p><b>[LL] (40M):</b> 7296×5472      <b>[LL] (30M):</b> 7296×4104</p> <p><b>When the aspect ratio is [3:2].</b>      <b>When the aspect ratio is [1:1].</b></p> <p><b>[XL] (71.5M):</b> 10368×6912      <b>[XL] (60.5M):</b> 7776×7776</p> <p><b>[LL] (35.5M):</b> 7296×4864      <b>[LL] (30M):</b> 5472×5472</p>
<b>[Quality]</b>	<p>Set the compression rate at which the pictures are to be stored.</p> <p><b>[] (JPEG images with priority given to picture quality)/[RAW<sup>+</sup>]</b> (simultaneous recording of RAW+JPEG images)/[RAW] (RAW images)</p>
<b>[Simul Record Normal Shot]</b>	<p>Saves the first picture of pictures taken before the combining process in addition to a combined picture if [ON] is selected. Pictures will be saved with [Picture Size] set to [L].</p> <p><b>[ON]/[OFF]</b></p>
<b>[Shutter Delay]</b>	<p>Sets the delay between the time the shutter button is pressed to the time the shutter is released.</p> <p><b>[30 SEC]/[15 SEC]/[8 SEC]/[4 SEC]/[2 SEC]/[1 SEC]/[1/2 SEC]/[1/4 SEC]/[1/8 SEC]/[OFF]</b></p>

• The available setting ranges of the following functions during [High Resolution Mode] recording will differ from those during normal picture recording.

- Minimum aperture value: F8
- Shutter speed: 1 to 1/32000th
- ISO sensitivity: Up to [ISO 1600]
- Focus mode: Fixed to [AFS] or [MF]

### [Silent Mode]

**Applicable modes:**

Disables operational sounds and output of light at once.

**MENU** → **[Rec]** → **[Silent Mode]**

**Settings:** **[ON]/[OFF]**

- Audio from the speaker will be muted and the flash and the AF Assist lamp will be disabled. The following settings are fixed.
  - [Flash Mode]: (forced flash off)
  - [Shutter Type]: [ESHTR]
  - [AF Assist Lamp]: [OFF]
  - [Beep Volume]: (OFF)
  - [E-Shutter Vol]: (OFF)
- Even when [ON] is set, the following functions light up/flash.
  - Charging lamp/WIRELESS connection lamp
  - Self-timer indicator
- Sounds that are produced by the camera regardless of your operations, such as the lens aperture sound, cannot be muted.
- **Be sure to pay special attention to the privacy, the likeness rights, etc. of the subject when you use this function. Use at your own risk.**



**[Shutter Type]**

Applicable modes:   **P** **A** **S** **M**  

Select the shutter type to be used for taking pictures.

**MENU** →  **[Rec]** → **[Shutter Type]**

Settings: **[AUTO]/[MSHTR]/[EFC]/[ESHTR]**

	Mechanical shutter	Electronic Front Curtain	Electronic Shutter
Description	The camera starts and ends an exposure with the mechanical shutter.	The camera starts an exposure electronically, and ends it with the mechanical shutter.	The camera starts and ends an exposure electronically.
Flash	○	○	—
Shutter Speed (Sec.)	B (Bulb) <sup>*1</sup> / 60 to 1/8000th	B (Bulb) <sup>*1</sup> / 60 to 1/2000th	1 <sup>+2</sup> to 1/32000th
Shutter sound	Mechanical shutter sound	Mechanical shutter sound	Electronic shutter sound

\*1 This setting is available only in Manual Exposure Mode.

\*2 Up to an ISO sensitivity of [ISO3200]. When the setting is higher than [ISO3200], the shutter speed will be faster than 1 second.

- Compared to Mechanical Shutter Mode, Electronic Front Curtain Mode produces less shutter-induced shake, so it can minimise the influence of shutter vibration.
- Electronic Shutter Mode allows you to take pictures without causing shutter vibration.

**[Luminance Level]**

Applicable modes:   **P** **A** **S** **M**  

Select the luminance range to match the use of video.

**MENU** →  **[Motion Picture]** → **[Luminance Level]**

Settings: **[0-255]/[16-255]**

- This function works only for motion pictures. Still pictures (including those you take during motion picture recording) will be taken with [0-255].

**[Economy]**

The camera can be set up to prevent unnecessary battery consumption.

**MENU** →  **[Setup]** → **[Economy]**







<b>[Sleep Mode]</b>	The camera is automatically turned off if the camera has not been used for the time selected on the setting.	
<b>[Sleep Mode(Wi-Fi)]</b>	The camera is automatically turned off if it is not connected to a Wi-Fi network and has not been used for 15 minutes (approx.).	
<b>[Auto LVF/Monitor Off]</b>	The monitor/viewfinder is automatically turned off if the camera has not been used for the time selected on the setting.	
<b>[Power Save LVF Shooting]</b>	If you display the monitor using the viewfinder/monitor automatic switching function, the camera will turn off automatically after being left idle.	
	<b>[Time]</b>	Sets the amount of time before the camera turns off automatically. <b>[10SEC]/[5SEC]/[3SEC]/[2SEC]/[1SEC]/[OFF]</b>
	<b>[Display]</b>	Sets whether to turn off the camera automatically only while the [Monitor Info. Disp.] screen is displayed or while any screen is displayed.

- To cancel [Sleep Mode], [Sleep Mode(Wi-Fi)] or [Power Save LVF Shooting], perform either of the following operations:
  - Press the shutter button halfway.
  - Turn off and on the camera.
- To turn the monitor/viewfinder on again, press any button.

**[Night Mode]**

This displays the monitor and the viewfinder screens in red. It reduces the glare on the screens when recording in low-light environment such as at night.

**MENU** →  **[Setup]** → **[Night Mode]**

- 1 Press /// to select [ON] for the red display setting of the monitor or viewfinder (LVF).
- 2 Press [DISP.] to display the brightness adjustment screen.
- 3 Press / to adjust the brightness, and press [MENU/SET].

## [Folder / File Settings]

Set the folder and file name patterns in which images are to be saved.

Folder name		File name	
100ABCDE 		PABC0001.JPG 	
①	Folder number (3-digits, 100–999)	①	Colour space ([P]: sRGB, [_]: AdobeRGB)
②	5-digit user-defined segment	②	3-digit user-defined segment
		③	File number (4-digits, 0001–9999)
		④	File extension

### MENU → ⚙ [Setup] → [Folder / File Settings]



[Select Folder]*	Specifies the folder to which images are to be saved. • The folder name is indicated with the number of files that can be stored.	
[Create a New Folder]	[OK]	Creates a new folder with the same 5-digit user-defined segment as the current folder name setting.
	[Change]	Allows you to redefine the 5-digit user-defined segment before creating a new folder. • A new folder with an incremented folder number is created.
[File Name Setting]	[Folder Number Link]	Uses the folder number of the folder name as the file name's 3-digit user-defined segment.
	[User Setting]	Allows you to define and set the 3-digit user-defined segment of the file name.

- \* When [Double Slot Function] is set to [Allocation Rec], [Select Folder (SD1)] and [Select Folder (SD2)] are displayed.
- File numbers are assigned sequentially from 0001 to 9999 in the order of recording. If you change the storage folder, a continuing number from the last file number will be assigned.

**[Double Slot Function]**

Set the way recording to the card slots 1 and 2 is performed.

**MENU** →  **[Setup]** → **[Double Slot Function]**

<b>[Recording Method]</b>	 <b>([Relay Rec])</b>	Relays recording to the other card slot even after the first card runs out of free space during recording. <b>[Destination Slot]: [1→2]/[2→1]</b> • If you keep replacing the full card before the other card runs out of free space during motion picture recording, you can perform recording for a long period of time using 3 or more cards. Replace the card when there is still sufficient free space left on the card being used for recording.
	 <b>([Backup Rec])</b>	Records same images to the two cards.
	 <b>([Allocation Rec])</b>	Allows you to specify the card slot to be used for recording for different image formats. <b>[JPEG Destination]/[RAW Destination]/[6K/4K Photo Destination]/[Video Destination]</b>

**Notes on the Relay Rec. function**

- In the following cases, recording cannot be relayed to the other card:
  - When recording a motion picture in [AVCHD] format

**Notes on the Backup Rec. function**

- We recommend using cards with the same Speed Class rating and capacity.
- When recording a motion picture in [AVCHD] format, backup recording of motion picture is not possible. Data will be recorded only to the one card.
- When different types of cards (SDHC/SDXC) are inserted in any of the following situations, recording cannot be performed to the cards:
  - When recording motion pictures (Excluding [AVCHD])
  - When recording 6K/4K photos
  - When recording with the Post Focus function

## [Save/Restore Camera Setting]

Save the camera's setup information to the card. Since saved setup information can be imported to the camera, you can apply the same setup to more than one camera.

- Save/load setup information using the card inserted to the card slot 1.

**MENU** →  **[Setup]** → **[Save/Restore Camera Setting]**

<b>[Save]</b>	Saves the camera's setup information to the card.	
	<ul style="list-style-type: none"> <li>• To save new information, select [New File]; to overwrite an existing file, select that file.</li> <li>• When [New File] has been selected, the name of the file to be saved is displayed on the screen.</li> </ul>	
	<b>[OK]</b>	Saves the file with an automatically created name displayed on the screen.
	<b>[Change the file name]</b>	Allows you to rename the file before saving it.
<b>[Load]</b>	Loads the setup information on the card to the camera.	
<b>[Delete]</b>	Deletes the setup information on the card.	

- Setup information can be loaded only to cameras of the same model as this camera.
- You can save up to 10 sets of setup information to one card.

## [No.Reset]

Reset the file number of the next recording to 0001.

### Settings: [Slot 1]/[Slot 2]

- When recording is performed after resetting this item, the folder number is updated and the file number starts from 0001.
- A folder number between 100 and 999 can be assigned.  
The folder number should be reset before it reaches 999. We recommend formatting the card after saving the data on a PC or elsewhere.
- To reset the folder number to 100:
  - 1 Format the card.
  - 2 Perform [No.Reset] to reset the file number.
  - 3 Select [Yes] on the folder number reset screen.

## [Reset]

The following settings are reset to the default:

- Recording settings
- Setup settings ([Wi-Fi Setup] and [Bluetooth] settings)
- Custom settings ([Face Recog.] and [Profile Setup] settings)
- Setup/custom settings (except for [Wi-Fi Setup], [Bluetooth], [Face Recog.] and [Profile Setup])

## [My Menu Setting]

Register frequently-used menus and display them in [My Menu]. You can register up to 23 menus.





**MENU** →  **[My Menu]** → **[My Menu Setting]**

<b>[Add]</b>	Specifies the menu to be displayed in My Menu to register it.
<b>[Sorting]</b>	Rearranges the menus displayed in My Menu. Select the menu you want to move and set the destination.
<b>[Delete]</b>	Deletes registered menus from the displayed menu list. <b>[Delete Item]:</b> Deletes a selected menu from the displayed menu list. <b>[Delete All]:</b> Deletes all of the displayed menus.
<b>[Display from My Menu]</b>	Sets the type of the menu screen to be displayed. <b>[ON]:</b> Displays My Menu. <b>[OFF]:</b> Displays the last-used menu.

## [RAW Processing]

You can process the pictures taken in RAW format. The processed pictures will be saved in JPEG format.

**MENU** →  **[Playback]** → **[RAW Processing]**

- 1 Select RAW images with  , and then press **[MENU/SET]**.
- 2 Press   to select an item.
  - You can set the following items. The settings you used for the recording are selected when you start setting these items.



[White Balance]

[Brightness correction]

[Photo Style]

[i.Dynamic]

[Contrast]

[Highlight]

[Shadow]

[Saturation]/[Color Tone]



[Filter Effect]

[Noise Reduction]







[i.Resolution]

[Sharpness]

[Setup]

- 3 Press **[MENU/SET]** and set.
- 4 Press **[MENU/SET]**.
  - This operation returns you to the screen in step 2. To set other items, repeat steps 2 through 4.
- 5 Select **[Begin Processing]** with  , and then press **[MENU/SET]**.

## ■ How to set each item

Button operation	Touch operation	Description of operation
	<b>Dragging</b>	Selects a setting.
	<b>[WB K Set]</b>	Displays the screen that lets you set the colour temperature. (only when [White Balance] is set to [  ], [  ], [  ], [  ])
	<b>[Adjust.]</b>	Displays the screen that lets you fine-adjust the White Balance. (only when [White Balance] is set)
<b>[DISP.]</b>	<b>[DISP.]</b>	Displays the comparison screen.
<b>[MENU/SET]</b>	<b>[Set]</b>	Sets the adjusted level and returns you to the item selection screen.

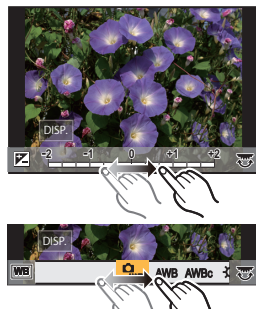



- When [Noise Reduction], [i.Resolution] or [Sharpness] is selected, the comparison screen cannot be displayed.
- Each time you touch the screen twice, the display switches between enlarged and normal view.

On the comparison screen, you can use the following operations to make adjustments:

- Ⓐ Current setting

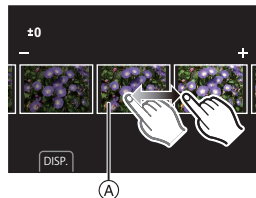
Button operation	Touch operation	Description of operation
	<b>Dragging</b>	Selects a setting.
<b>[DISP.]</b>	<b>[DISP.]</b>	Returns you to the setting screen.
<b>[MENU/SET]</b>	<b>[Set]</b>	Sets the adjusted level and returns you to the item selection screen.



- If you touch the picture at the centre, it will be enlarged. If you touch , the picture will be reduced to the original size.

### [Setup] setting

When you select an item, the screen that asks you to select [Reinstate Adjustments], [Color Space], or [Picture Size] will be displayed.

- 1 Press **▲/▼** to select an item, and press **[MENU/SET]**.
  - If you select [Reinstate Adjustments], a confirmation screen will be displayed. Selecting [Yes] will execute the operation and return you to the item selection screen.
- 2 Press **▲/▼** to select a setting, and press **[MENU/SET]**.

# What you can do with the Wi-Fi®/Bluetooth® function

- The camera cannot be used to connect to a public wireless LAN connection.

## Controlling with a Smartphone/Tablet (P94)

- Recording with a smartphone (P95)
- Playing back or saving images stored on the camera, or uploading them on social media sites (P97)

## Explore more enjoyment possibilities with Bluetooth®

You can connect to a smartphone that supports Bluetooth low energy any time.

Connect to a smartphone to use a full range of features.

- Connecting easily by pairing (P90)
- Turning on/off the camera by remote control (P95)
- Operating the shutter button of the camera (P96)
- Sending recorded images automatically
- Auto Cloud Backup
- Recording location information to the camera's images
- Synchronising the camera's clock
- Saving the camera's setup information to a smartphone

## Displaying pictures on a TV

### Printing Wirelessly

### Sending images to AV device

### Sending images to PC

### Using Web services

These operating instructions refer to both smartphones and tablets as smartphones from this point on unless noted otherwise.

- For details, refer to the "Operating Instructions for advanced features (PDF format)".

## ■ About the WIRELESS connection lamp

Lit blue	Wi-Fi	When the Wi-Fi function is ON or connected by Wi-Fi
	Bluetooth	When the Bluetooth function is ON or connected by Bluetooth
Blinking blue	When sending data	

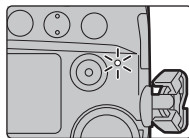

- In [Wireless Connection Lamp] in the [Setup] menu, you can set the lamp so that it will not light/flash.

## ■ About the [Wi-Fi] button

In these operating instructions, a function button to which [Wi-Fi] is assigned is referred to as the [Wi-Fi] button.

(By default, [Wi-Fi] is assigned to [Fn6] when the camera is in Recording Mode, while it is assigned to [Fn1] when the camera is in Playback Mode.)

- For information about the function button, refer to P30.



**Steps for pressing [Wi-Fi] (in Recording Mode)**

- 1 Touch [Wi-Fi].
- 2 Touch [Wi-Fi].

**■ Use the camera as a wireless LAN device**

When using equipment or computer systems that require more reliable security than wireless LAN devices, ensure that the appropriate measures are taken for safety designs and defects for the systems used. Panasonic will not take any responsibility for any damage that arises when using the camera for any purpose other than as a wireless LAN device.

**■ Use of the Wi-Fi function of this camera is presumed to be in countries where this camera is sold**

There is the risk that the camera violates the radio wave regulations if used in countries other than those where this camera is sold, and Panasonic takes no responsibility for any violations.

**■ There is the risk that data sent and received via radio waves may be intercepted**

Please note that there is the risk that data sent and received via radio waves may be intercepted by a third party.

**■ Do not use the camera in areas with magnetic fields, static electricity or interference**

- Do not use the camera in areas with magnetic fields, static electricity or interference, such as near microwave ovens. These may cause the interruption of the radio waves.
- Using the camera near devices such as microwave ovens or cordless telephones that use the 2.4 GHz radio wave band may cause a decrease in performance in both devices.

**■ Do not connect to the wireless network you are not authorised to use**

When the camera utilises its Wi-Fi function, wireless networks will be searched automatically. When this happens, wireless networks that you are not authorised to use (SSID\*) may be displayed, however do not attempt to connect to the network as it may be considered as unauthorised access.

- \* SSID refers to the name that is used to identify a network over a wireless LAN connection. If the SSID matches for both devices, transmission is possible.

# Connecting to a smartphone/tablet

## Installing the smartphone/tablet app “Image App”

The “Panasonic Image App” (hereafter “Image App”) is an application provided by Panasonic.

### • OS

App for Android™: Android 4.2 or higher  
**(Android 5.0 or higher is required to use the Bluetooth function)**

App for iOS: iOS 9.0 or higher  
 (The Bluetooth function cannot be used with the iPad 2)

- 1 **Connect the smartphone to a network.**
- 2 **(Android) Select “Google Play™ Store”.**  
**(iOS) Select “App Store”.**
- 3 **Enter “Panasonic Image App” or “LUMIX” into the search box.**
- 4 **Select “Panasonic Image App”  and install it.**



- Use the latest version.
- Supported OSs are current as of November 2017 and are subject to change.
- Read the [Help] in the “Image App” menu for further details on how to operate.
- When you operate the “Image App” on the smartphone that is connected to the camera via Wi-Fi, [Help] in the “Image App” may not be displayed depending on the smartphone. In this case, after terminating the connection to the camera, reconnect the smartphone to a mobile phone network such as the 3G or LTE network or to a Wi-Fi router, and then display [Help] in the “Image App”.
- Some of the screens and information provided in these operating instructions may differ from your device depending on the supported OS and “Image App” version.
- The service may not be able to be used properly depending on the type of smartphone being used.

For information on the “Image App”, refer to the support site below.

<http://panasonic.jp/support/global/cs/dsc/>

(This Site is English only.)

- When downloading the app on a mobile network, high packet communication fees may be incurred depending on the details of your contract.

## Using a smartphones that supports Bluetooth low energy

Follow a simple connection setup procedure (pairing) to connect to a smartphone that supports Bluetooth low energy. When pairing is set up, the camera also automatically connects to the smartphone via Wi-Fi.

### • Supported smartphones

**Android: Android 5.0 or higher equipped with Bluetooth 4.0 or higher (excluding those that do not support Bluetooth low energy)**

**iOS: iOS 9.0 or higher (excluding the iPad 2)**

## On the camera

## Select the menu.

**MENU** →  **[Setup]** → **[Bluetooth]** → **[Bluetooth]** → **[SET]** → **[Pairing]**

- The camera enters pairing standby mode and displays its device name.

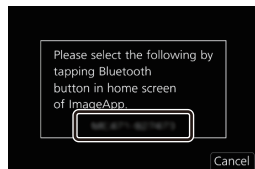

## On your smartphone

**1 Start “Image App”.**

- If a message is displayed indicating that the smartphone is searching for cameras, close the message.

**2 Select [Bluetooth].****3 Turn on the Bluetooth.****4 Select the device name displayed on the camera’s screen from the [Camera enable to be registered] list.**

- Bluetooth connection between the camera and the smartphone will be made.  
(For Android devices) A Wi-Fi connection will be made by selecting [Connection].

**If you are using an Android device, follow the steps up to here to complete the setup. Proceed to the steps below only if you are using an iOS device.**

- If [Wi-Fi Password] is set to [OFF] on the camera, select [Wi-Fi Setup]. (At the time of purchase, [Wi-Fi Password] is set to [OFF])
- If [Wi-Fi Password] is set to [ON] on the camera, you need to install the profile.

**1 Install the profile.**

- If a pass code is set on the smartphone, you need to enter it.

**2 Press the home button to close the browser.****5 Turn on the Wi-Fi function in the smartphone’s setting menu.****6 On the Wi-Fi setting screen, select the SSID (the device name selected in step 4) displayed on the camera.**

- If the SSID is not displayed, it may be displayed after the Wi-Fi function is turned off and on.



**7 Press the home button, and select “Image App” to display “Image App”.**

- The paired smartphone will be registered as a paired device after connected via Wi-Fi.
- Pairing needs to be set up only for the first connection. For the second and subsequent connections: (P92)



When connected via Bluetooth, the camera automatically makes a Wi-Fi connection.

- (iOS devices) If you need to change the connected device on the Wi-Fi setup screen, follow the on-screen message to change the setting.

- [] is displayed on the recording screen during Bluetooth connection. When the Bluetooth function is enabled, but a connection is not established, [] appears translucent.

## ■ Connecting to the paired smartphone (connecting for the second and subsequent times)

On the camera

**MENU** → ⚙ [Setup] → [Bluetooth] → [Bluetooth] → [ON]

On your smartphone

- 1 Start “Image App”.
  - If a message is displayed indicating that the smartphone is searching for cameras, close the message.
- 2 Select [Bluetooth].
- 3 Turn on the Bluetooth.
- 4 Select the camera (device name) you want to connect to from the [Camera registered] list.

If you set [Bluetooth] to [ON] on the camera in advance, you can make a connection just by operating the smartphone.

## ■ Terminating the Bluetooth connection to the smartphone and disabling the Bluetooth function

Select the camera’s menu.

**MENU** → ⚙ [Setup] → [Bluetooth] → [Bluetooth] → [OFF]

## Using a smartphone that does not support Bluetooth low energy

Connect to a smartphone via Wi-Fi.

- You can also connect via Wi-Fi to a smartphone that supports Bluetooth low energy by following the same steps.

## Connecting without using the password

You can easily set up a direct connection to your smartphone without entering a password.

On the camera

**MENU** → ⚙ [Setup] → [Wi-Fi] → [Wi-Fi Function] → [New Connection] → [Remote Shooting & View]

- (A) SSID
  - When the camera is ready to be connected to the smartphone, the SSID is displayed.
  - You can also display the information by pressing [Wi-Fi] on the camera.



## On your smartphone

- 1 Turn on the Wi-Fi function in the setting menu.
- 2 On the Wi-Fi setting screen, select the SSID displayed on the camera.
- 3 Start "Image App".
  - When the connection confirmation screen is displayed on the camera, select [Yes] to connect. (For first time connection only)

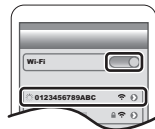
**At the time of purchase, [Wi-Fi Password] is set to [OFF].**

Before connecting to a Wi-Fi network, ensure that the device displayed on the connection confirmation screen is the one you actually want to connect to. When a wrong device is displayed, if you select [Yes], the camera will automatically connect to that device.

We recommend that you set [Wi-Fi Password] to [ON] if, for example, there is another Wi-Fi device nearby.

## Using a password to set up a connection

Preparations:

Set the [Wi-Fi Password] to [ON].

**MENU** → ⚙ [Setup] → [Wi-Fi] → [Wi-Fi Setup] → [Wi-Fi Password] → [ON]

## On the camera

**MENU** → ⚙ [Setup] → [Wi-Fi] → [Wi-Fi Function] → [New Connection] → [Remote Shooting & View]

- (A) SSID and password
- (B) QR code

- When the camera is ready to be connected to the smartphone, the QR code, SSID and password are displayed.
- You can also display the information by pressing [Wi-Fi] on the camera.

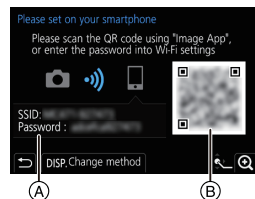

## On your smartphone

- 1 Turn on the Wi-Fi function in the setting menu.
- 2 On the Wi-Fi setting screen, select the SSID displayed on the camera.
- 3 Enter the password displayed on the camera into the smartphone. (For first time connection only)
- 4 Start "Image App".



## Terminating the Wi-Fi connection

- 1 Set the camera to Recording Mode.
- 2 Select the camera's menu items to terminate the Wi-Fi connection.

**MENU** →  [Setup] → [Wi-Fi] → [Wi-Fi Function] → [Yes]



- You can also terminate the connection by pressing [Wi-Fi] on the camera.

- 3 On the smartphone, close "Image App".

## Controlling with a Smartphone/Tablet

### ■ Required wireless connectivity mode

The wireless connectivity mode required varies depending on the function to be used after connecting to a smartphone.

Wireless connectivity required	Support for Bluetooth low energy
	Indicates that the function can be used with smartphones that support Bluetooth low energy.
	Indicates that the function can be used with smartphones that do not support Bluetooth low energy.
	Indicates that the function can be used with smartphones that support Bluetooth low energy. • Indicates that the function requires you to connect to a smartphone using both Bluetooth and Wi-Fi.

## Turning on/off the camera with a smartphone

Wireless connectivity required: Bluetooth Wi-Fi

The function allows you to view images on the camera placed in your bag, or turn on the camera left in a separate place only when you record images with it.

- 1 Make a Bluetooth connection to the smartphone. (P90)
- 2 Select the camera's menu.

**MENU** → [Setup] → [Bluetooth] → [Remote Wakeup] → [ON]

- 3 Set the camera on/off switch to [OFF].
- 4 On the smartphone, start up the "Image App", and set the Bluetooth function to a state in which a connection can be made (standby state).
- 5 Operate the smartphone.

1 Select [ ].

2 Select [Remote operation].



- The camera automatically turns on, allowing it to make a Wi-Fi connection automatically.
  - (iOS devices) Depending on the connection status of the smartphone, you may need to change the connected device on the Wi-Fi setup screen. Follow the on-screen message on the smartphone to change the setting.

### ■ Turning off the camera with the smartphone

1 Select [ ].

2 Select [ OFF ].

- When [Remote Wakeup] is set to [ON], the Bluetooth function continues to operate even after the camera is turned off, thus causing the battery to drain.

## Taking images via a smartphone/tablet (remote recording)

Wireless connectivity required: Wi-Fi

- 1 Connect to a smartphone. (P90)
- 2 Operate the smartphone.

1 (When connected via Bluetooth) Select [ ].

2 (When connected via Bluetooth) Select [Remote operation].



- Make a Wi-Fi connection automatically. (iOS devices) If you need to change the connected device on the Wi-Fi setup screen, follow the on-screen message to change the setting.

3 Select [ ].



4 Record an image.

- The recorded images are saved in the camera.
- Some settings are not available.



## ■ Changing the camera's dial settings, etc. with your smartphone

**MENU** →  **[Setup]** → **[Wi-Fi]** → **[Wi-Fi Setup]** → **[Priority of Remote Device]**

 <b>[Camera]</b>	<p>Allows you to perform operations with both the camera and the smartphone during remote recording.</p> <ul style="list-style-type: none"> <li>• The camera's dial settings, etc. cannot be changed with the smartphone.</li> </ul>
 <b>[Smartphone]</b>	<p>Allows you to perform operations only with the smartphone during remote recording.</p> <ul style="list-style-type: none"> <li>• The camera's dial settings, etc. can be changed with the smartphone.</li> <li>• To end remote recording, press any of the buttons on the camera to turn on the screen, and select <b>[End]</b>.</li> </ul>

## Operating the shutter button with a smartphone via a Bluetooth connection alone

**Wireless connectivity required:** **Bluetooth**

### 1 Make a Bluetooth connection to the smartphone. (P90)

### 2 Operate the smartphone.

- ① Select [  ].
- ② Select [Shutter Remote Control].
- ③ Remotely operate the shutter button or motion picture button of the camera.
  - For details, refer to the help section in the "Image App" menu.
  - The live view image of the camera cannot be monitored on the smartphone.



- To cancel [Sleep Mode] with this function, select the following settings and connect via Bluetooth.

– [Remote Wakeup]: [ON]

– [Auto Transfer]: [OFF]

- When the camera is turned off, even if you set [Remote Wakeup] to [ON] on the camera, it cannot be turned on with this function.



## Playing back/saving images stored on the camera, or uploading them on social media sites

Wireless connectivity required: Wi-Fi

### 1 Connect to a smartphone. (P90)

### 2 Operate the smartphone.

- If the smartphone is already connected via Wi-Fi, proceed to step 3.

- 1 (When connected via Bluetooth) Select [  ].
- 2 (When connected via Bluetooth) Select [Remote operation].

- Make a Wi-Fi connection automatically.
  - (iOS devices) Depending on the connection status of the smartphone, you may need to change the connected device on the Wi-Fi setup screen. Follow the on-screen message on the smartphone to change the setting.

### 3 Select [ ].

- You can switch the images to be displayed by selecting the icon (A) on the top left of the screen. To display images stored in the camera, select [LUMIX(SD1)] or [LUMIX(SD2)].

### (To play back the image)

#### 4 Touch the image to enlarge it.

#### (To save the image or upload it on a social media site or other web service)

#### 5 Touch and hold an image, and drag it to save it.

- When you play a motion picture, image quality differs from that of the actual recorded motion picture. The image quality may deteriorate or the sound may skip during motion picture or picture playback.
- An OS version of Android 7.0 or higher or iOS 10.0 or higher is required to save pictures in RAW format.
- Depending on the smartphone or its OS version, pictures in RAW format may not be displayed correctly.
- You cannot save the following types of images:
  - Motion pictures in [AVCHD], [MP4] (only those with a size of [4K]) format
  - 6K/4K burst files
  - Images recorded with the Post Focus function

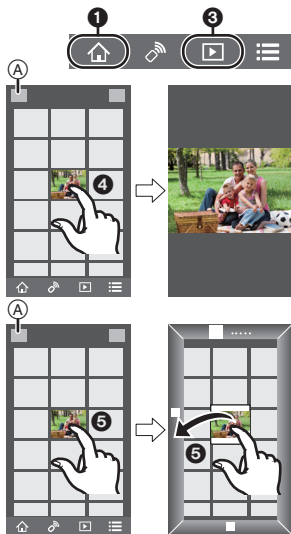

# Setting up a connection to a PC via a wireless access point

## ■ To create a folder that receives images

- Create a PC account name (up to 254 characters) and password (up to 32 characters) consisting of alphanumeric characters. An attempt to create a receive folder may fail if the account name includes non-alphanumeric characters.

When using "PHOTOfunSTUDIO" (For Windows)

- 1 Install "PHOTOfunSTUDIO" to the PC. (P100)
- 2 Create a folder that receives images with "PHOTOfunSTUDIO".
  - To create the folder automatically, select [Auto-create]. To specify a folder, create a new folder, or set a password to the folder, select [Create manually].
  - For details, refer to the operating instructions of "PHOTOfunSTUDIO" (PDF).

When not using "PHOTOfunSTUDIO" (For Mac)

Supported OS: OS X v10.5 to v10.11, macOS 10.12

Example: OS X v10.8

- 1 Select a folder you intend to use for receiving, then click on the items in the following order.  
[File] → [Get Info]
- 2 Enable sharing of the folder.
  - For details, refer to the operating instructions of your PC or Help on the OS.

## ■ Sending images to the PC

The connection methods described in this manual are examples. For details on other connection methods, refer to "Operating Instructions for advanced features (PDF format)".

Preparations:

- If the workgroup of the destination PC has been changed from the standard setting, change the setting of this unit in [PC Connection].

- 1 Select the menu.

**MENU** →  [Setup] → [Wi-Fi] → [Wi-Fi Function] → [New Connection]

- 2 Select the connection method.

**Sending an image each time a recording is made**  
([Send Images While Recording])

Available file format: JPEG/RAW

**Select and send the images** ([Send Images Stored in the Camera])

Available file format: ALL format

**3 Select [PC].****4 Select the connection method.****Example: Selecting [WPS (Push-Button)] to set up a connection**

- ❶ Select [Via Network].
- ❷ Select [WPS (Push-Button)].
- ❸ Press the wireless access point WPS button until it switches to WPS mode.

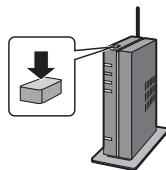
**5 On the camera, perform the operation that matches your purpose.**

**Sending an image each time a recording is made  
([Send Images While Recording])**

- ❶ Select the PC you want to connect to and the destination folder.
- ❷ Check the send settings, and select [Set].
- ❸ Take a picture with the camera.

• To terminate the connection, follow the steps below:

**MENU** → [Setup] → [Wi-Fi] → [Wi-Fi Function] → [Yes]

**Select and send the images ([Send Images Stored in the Camera])**

- ❶ Select the PC you want to connect to and the destination folder.
  - ❷ Check the send settings, and select [Set].
  - ❸ Select [Single Select] or [Multi Select], and then select the images you want to send.
- To change the send setting, press [DISP.]. To terminate the connection, select [Exit].

- Folders sorted by the sent date are created in the specified folder, and pictures are saved in those folders.
- If the screen for a user account and password entry appears, enter the one you set on your PC.
- When the computer name (NetBIOS name for Mac) contains a space (blank character), etc., it may not be recognised.  
In that case, we recommend changing the name to one consisting only of 15 or less alphanumeric characters.
- When [Auto Transfer] in [Bluetooth] is set to [ON], [Wi-Fi Function] is not available.

## Playing Back Pictures on a TV Screen

Preparations: Turn this unit and the TV off.

### 1 Connect the camera and the TV with an HDMI cable.

- Check the direction of the terminals and plug in/out straight holding onto the plug. (It may result in malfunction by the deforming of the terminal if it is plugged in obliquely or in wrong direction.)

Do not connect devices to incorrect terminals. Doing so may cause malfunction.

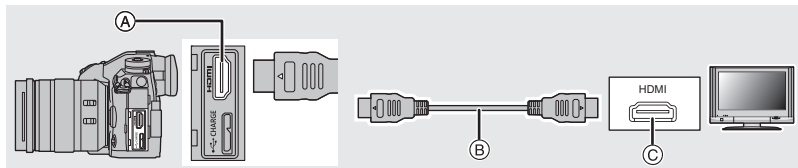

Ⓐ [HDMI] socket (Type A)

Ⓑ HDMI cable

Ⓒ HDMI socket (on the TV)

### 2 Turn on the TV and select the input to match the connector in use.

### 3 Turn the camera on and then press [▶].

- Read the operating instructions for the TV.
- Use a "High Speed HDMI cable" with the HDMI logo. Cables that do not comply with the HDMI standards will not work. "High Speed HDMI cable" (Type A–Type A plug, up to 1.5 m (4.9 feet) long)

## Saving still pictures and motion pictures on your PC

You can acquire recorded pictures to a PC by connecting the camera and the PC.

### Downloading software

- To download the software, you need to connect the PC to the Internet.
- It may take some time to download the software depending on the communication environment.
- Supported OSs are current as of November 2017 and are subject to change.

**PHOTOfunSTUDIO 10.0 PE**  
(Windows 7/Windows 8.1/Windows 10)

This software allows you to manage images. For example, you can send pictures and motion pictures to a PC and sort them by recording date or model name. You can also perform operations such as writing images to a DVD, processing and correcting images, and editing motion pictures.

Check the site below to download and install the software.

Download the software while it is available for download.

**[http://panasonic.jp/support/global/cs/soft/download/d\\_pfs10pe.html](http://panasonic.jp/support/global/cs/soft/download/d_pfs10pe.html)**

(This Site is English only.)

- Download expiration: January 2023
- For 4K motion pictures and 6K/4K photos, a 64 bit OS version of Windows 7/Windows 8.1/Windows 10 is required.
- For details about information such as the operating environment or operating method, refer to the “Operating Instructions for advanced features (PDF format)” or the operating instructions for the respective software programmes.
- “PHOTOfunSTUDIO” is not compatible with Mac.

#### **SILKYPIX Developer Studio SE**

**(Windows: Windows 7/Windows 8/Windows 8.1/Windows 10,**

**Mac: OS X v10.6 to v10.11, macOS 10.12)**

This is software to edit RAW format images.

Edited images can be saved in a format (JPEG, TIFF, etc.) that can be displayed on a personal computer.

Check the site below to download and install the software.

**<http://www.isl.co.jp/SILKYPIX/english/p/>**

- For details on how to use the SILKYPIX Developer Studio, refer to the Help or the Ichikawa Soft Laboratory’s support website.

#### **LoiLoScope 30 day full trial version**

**(Windows 7/Windows 8/Windows 8.1/Windows 10)**

This software allows you to edit motion pictures with ease.

Check the site below to download and install the software.

**<http://loilo.tv/product/20>**

- Only the trial version will be installed.
- For more information on how to use LoiLoScope, read the LoiLoScope manual available for download at the site.
- “LoiLoScope” is not compatible with Mac.

## **Transferring images to a PC**

Preparations:

Install “PHOTOfunSTUDIO” to the PC. (P100)

## 1 Connect the computer and camera with the USB connection cable (supplied).

- Please turn on this unit and your PC before connecting.
- Do not use any other USB connection cables except the supplied one.

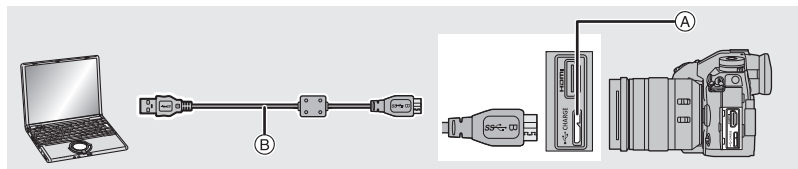

- Ⓐ [USB/CHARGE] socket      Ⓑ USB connection cable (supplied)

## 2 Press ▲/▼ to select [PC(Storage)], and then press [MENU/SET].

- If [USB Mode] is set to [PC(Storage)] in the [Setup] menu in advance, the camera will be automatically connected to the PC without displaying the [USB Mode] selection screen.

## 3 Copy the images to a PC using “PHOTOfunSTUDIO”.

- Do not delete or move copied files or folders in Windows Explorer.  
When viewing in “PHOTOfunSTUDIO”, you will not be able to play back or edit.

### ■ Copying to a PC without using “PHOTOfunSTUDIO” (For Mac)

Even if you are using a Mac, or in any situation where “PHOTOfunSTUDIO” cannot be installed, you can still copy files and folders by connecting the camera to the computer and then dragging and dropping them to it.

- The content (folder structure) on the card of this unit is as follows.

**For Windows:** A drive ([LUMIX]) is displayed in [Computer]

**For Mac:** A drive ([LUMIX]) is displayed on the desktop

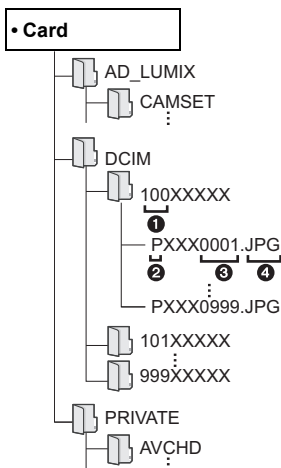

CAMSET:	The camera's setup information
DCIM:	Images
<b>1</b> Folder number	
<b>2</b> Colour space	P: sRGB _: AdobeRGB
<b>3</b> File number	
<b>4</b> JPG:	Still pictures
MP4:	[MP4] Motion pictures
RW2:	Pictures in RAW files
AVCHD:	[AVCHD] Motion pictures

# Controlling the Camera from a PC

## ■ Downloading software

### “LUMIX Tether”

This software is used to control a Panasonic digital camera from a PC. It allows you to change various settings of the camera, perform remote recording, and save remotely recorded images to the PC.

Check the site below to download and install the software.

[http://panasonic.jp/support/global/cs/soft/download/d\\_lumixtether.html](http://panasonic.jp/support/global/cs/soft/download/d_lumixtether.html)

### • Operating environment

OS	Windows	Windows® 7, Windows® 8.1, Windows® 10
	Mac	OS X v10.10 to v10.11, macOS 10.12
Interface	USB port (Super Speed USB (USB 3.0))	

- Supported OSs are current as of November 2017 and are subject to change.
- For details on how to use the “LUMIX Tether”, refer to the operation guide of “LUMIX Tether” (PDF file).

## ■ Operating the camera from a PC

Preparations:

Install “LUMIX Tether” to the PC.

### 1 Connect the computer and camera with the USB connection cable (supplied).

- Please turn on this unit and your PC before connecting.
- Do not use any other USB connection cables except the supplied one.

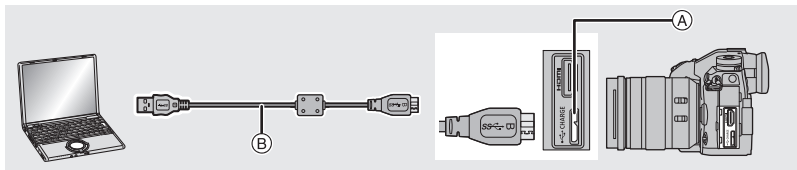

Ⓐ [USB/CHARGE] socket

Ⓑ USB connection cable (supplied)

### 2 Press ▲/▼ to select [PC(Tether)], and then press [MENU/SET].

- If [USB Mode] is set to [PC(Tether)] in the [Setup] menu in advance, the camera will be automatically connected to the PC without displaying the [USB Mode] selection screen.

### 3 Use “LUMIX Tether” to operate the camera from the PC.

- When the camera is connected to the PC via [PC(Tether)]:
  - The camera will be set to Recording Mode.
  - Wi-Fi/Bluetooth function cannot be used.
  - [ ] is displayed on the screen.
  - Instead of the number of recordable pictures, [PC] will appear on the screen if you perform recording without inserting a card into the camera.

# Monitor Display/Viewfinder Display

- The following images are examples of when the display screen is set to [ ] (monitor style) in the monitor.

## In recording

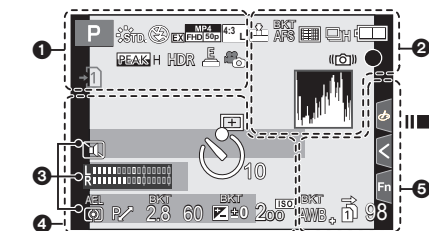



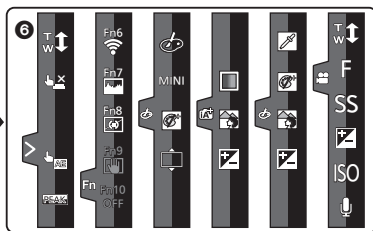















	Recording Mode (P23)
	Custom settings
C 1	Photo Style (P77)
	Flash Mode (P62)
	Flash
	Extra Tele Conversion (when recording motion pictures) (P61)
	Recording format/Recording quality (P64)
	Picture size/Aspect Ratio (P76)
	Extra Tele Conversion (when taking still pictures)
	Image effect (filter) adjustment display
EXPS	Image effect (filter) setting
	Card (displayed only during recording)



	No card
	The card is full
8m30s	Elapsed recording time*1 (P63)
	Simultaneous recording indicator
	Automatic viewfinder/monitor switching (P25)
	Peaking
	Highlight Shadow
HDR	HDR/iHDR
	Multi exposure
	Digital Zoom
	High-Res Mode (P79)
	Electronic shutter (P81)
180fps	High speed video (P67)
	Picture-taking during motion picture recording (Photo Priority)
	Overheat indicator (P110)











②

 RAW	Quality (P76)
AFS AFF AFC MF	Focus Mode (P35, 41)
 BKT AFS	Focus Bracket (P57)
	Post Focus (P52)
	AF Mode (P36)
	Face Recognition
AFL	AF Lock (P42)
	Burst (P47)
	6K/4K Photo (P48)
	Self-timer
	Battery indication
	Power is being supplied (P16)
<b>BG</b>	Battery Grip
DUAL2 DUAL 	Image Stabiliser (P59)
	Jitter alert
	Recording state (Flashes red./ Focus (Lights green.) (P20)
	Focus (Under low illumination)
	Focus (Starlight AF)
	Pre-Burst (P47)
	Connected to Wi-Fi
	Connected to Bluetooth (P91)
<b>GPS</b>	Location Logging
	Histogram







③

Name <sup>*2</sup>
Number of days that have passed since the departure date <sup>*3</sup>
Age <sup>*2</sup>
Location <sup>*3</sup>
Current date and time/Travel destination setting <sup>*3</sup> : 
Exposure meter
Focal distance display
Step zoom
Time Stamp Recording

④





















	AF area (P39)
+	Spot metering target
+	Centre marker display
	Self-timer
	Mic level display
<b>LMT</b> OFF	Mic Level Limiter (OFF)
	Silent Mode (P80)
	External Microphone
AEL	AE Lock (P42)
	Metering Mode (P79)
<b>P</b> 	Programme Shift (P23)
2.8	Aperture value (P20)
<b>BKT</b> 2.8	Aperture Bracket (P57)
60	Shutter speed (P20)
	Exposure compensation value (P42)
<b>BKT</b> <b>±0</b>	Exposure Bracket (P57)
	Brightness (P34)
	Manual Exposure Assistance
200 <b>ISO</b>	ISO sensitivity (P43)

5

	White Balance Bracket, White Balance Bracket (Colour Temperature) (P58)
	White Balance Fine Adjustment
	White Balance (P44)
	Colour (P34)
98	Number of recordable pictures
r20	Maximum number of pictures that can be taken continuously
8m30s	Available recording time <sup>*1</sup>
	Relay recording (P84)
	Backup recording (P84)
	Allocation recording (P84)

6

## Touch tab

	 Touch zoom
	 Touch Shutter (P27)
	 Touch AE (P27)
	 Peaking
	 Function button (P30)
	 Colour (P34)
 (P66)	 Defocus control function (P34)
	 Brightness (P34)
	 Type of defocus ([Miniature Effect])
	 One point colour
	 Position of the light source
	 Image effect (filter) adjustment
	 Image effect ON/OFF
	 Image effect (filter)
	 Aperture value (P20)
	 Shutter speed (P20)
	 ISO sensitivity (P43)
	 Microphone level adjustment

\*1 m: minute, s: second

\*2 This is displayed for about 5 seconds when the camera is turned on if the [Profile Setup] setting is set.

\*3 This is displayed for about 5 seconds when the camera is turned on, after setting the clock and after switching from Playback Mode to Recording Mode.

## In recording

## On-monitor recording information

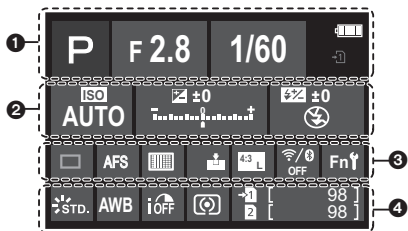

<b>1</b>		Recording Mode (P23)
	F2.8	Aperture value (P20)
	1/60	Shutter speed (P20)
		Battery indication
		Power is being supplied (P16)
		Card (displayed only during recording)

<b>2</b>		ISO sensitivity (P43)
	AUTO	Exposure compensation value (P42)
		Brightness (P34)
		Manual Exposure Assistance
		Flash Mode (P62)
		Flash

<b>3</b>		Single
		Burst (P47)
		6K/4K Photo (P48)
		Post Focus (P52)
		Self-timer
		High-Res Mode (P79)
	AFS AFF AFC MF	Focus Mode (P35, 41)
		AF Mode (P36)
		Quality (P76)
		Picture size/Aspect Ratio (P76)
		Wi-Fi/Bluetooth (P88)
	Fn	Function button setting (P30)

<b>4</b>		Photo Style (P77)
	AWB AWBc	White Balance (P44)
		Intelligent Dynamic Range Control
		Metering Mode (P79)
		Relay recording (P84)
		Backup recording (P84)
		Allocation recording (P84)
	98	Number of recordable pictures
	r20	Maximum number of pictures that can be taken continuously
	r8m30s	Available recording time
	---	No card

# Status LCD Indications

The camera's recording information is displayed.

\*All pieces of information are shown here for explanatory purposes.

## In recording

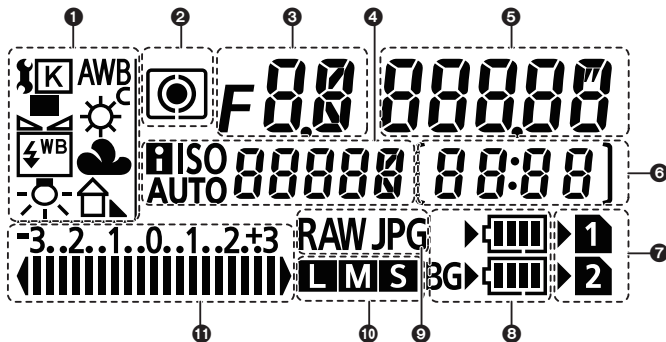

1	White Balance (P44)	7	Card slot (P17)
2	Metering Mode (P79)	8	Battery indication
3	Aperture value (P20)	9	Quality (P76)
4	ISO sensitivity (P43)	10	Picture size (P76)
5	Shutter speed (P20)		<ul style="list-style-type: none"> <li>This is not displayed when recording in [High Resolution Mode].</li> </ul>
6	Number of recordable pictures/ Maximum number of pictures that can be taken continuously/ Available recording time		Exposure compensation value (P42)/ Exposure Bracket (P57)
	<ul style="list-style-type: none"> <li>[9999] is displayed if there are 10000 or more recordable pictures remaining.</li> <li>If the remaining available recording time is 29 minutes and 59 seconds, it will be displayed as [29:59].</li> </ul>		<ul style="list-style-type: none"> <li>The status LCD displays an exposure compensation value ranging between <math>-3</math> EV and <math>+3</math> EV. Values outside this range are displayed as [ <math>\leftarrow</math>   <math>\rightarrow</math> ].</li> </ul>

### ■ Battery level indicator

- (A) This indicates the power supply source.
- (B) The battery level of the battery in the camera
- (C) The battery level of the battery in the battery grip

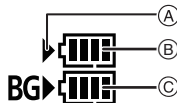

- The battery level icon for the battery in the camera is not displayed when a AC adaptor (optional) is used.
- Recording information is not displayed on the status LCD while an image is being played back or a menu screen is being displayed.

# Message Display

Confirmation messages or error messages will be displayed on the screen in some cases.

- Please also refer to the “Operating Instructions for advanced features (PDF format)”, which describes more detailed information.

## **[Some pictures cannot be deleted]/[This picture cannot be deleted]**

- This feature can only be used with pictures that comply with the DCF standard. Perform formatting (P19) on this unit after saving necessary data on a PC, etc.

## **[Memory Card Error Format this card?]**

- It is a format that cannot be used with this unit.
  - Insert a different card.
  - Format the card again with the camera after saving necessary data on a PC etc. (P19) Data will be deleted.

## **[The lens is not attached properly. Do not push lens release button while lens is attached.]**

- Detach the lens once, and then attach it again without pressing the lens release button. (P17) Turn this unit on again, and if it is still displaying, contact the dealer.

## **[Memory Card Error]/[This memory card cannot be used]**

- Use a card compatible with this unit. (P8)

## **[Insert SD card again]/[Try another card]**

- An error has occurred accessing the card. Insert the card again.
- Insert a different card.

## **[Read Error/Write Error Please check the card]**

- It has failed to read or write data. Remove the card after turning this unit off. Insert the card again, turn this unit on, and try to read or write the data again.
- The card may be broken.
- Insert a different card.

## **[This battery cannot be used]**

- Use a genuine Panasonic battery. If this message is displayed even when a genuine Panasonic battery is used, contact the dealer or Panasonic.
- If the battery terminal is dirty, clean it and remove any objects.

## **[Failed to connect wireless access point]/[Connection failed]/[No destination found]**

- The wireless access point information set on this unit is wrong. Check the authentication type, encryption type, and encryption key.
- Radio waves from other devices may block the connection to a wireless access point. Check the status of other devices that are connected to the wireless access point as well as the status of other wireless devices.

# Troubleshooting

First, try out the following procedures.

**If the problem is not resolved, it may be improved by selecting [Reset] on the [Setup] menu.**

- Please also refer to the “Operating Instructions for advanced features (PDF format)”, which describes more detailed information.

## **When I shake the camera, I hear a rattling sound.**

- The sound is caused by the In-Body Image Stabiliser. This is not a malfunction.

## **Recording stops before finishing. Cannot record. Cannot use some functions.**

- When the ambient temperature is high or continuous recording is performed, the camera's temperature will rise. After [] is displayed, recording may stop or the functions below may be temporarily disabled to protect the camera. Wait until the camera cools down.
  - 6K/4K Photo
  - Post Focus
  - Motion picture recording
  - AF Point Scope
  - HDMI output
  - Power supply via the USB connection cable

## **The camera cannot be operated even when it is turned on.**

### **The camera turns off immediately after it is turned on.**

- The battery is exhausted.
  - Charge the battery. (P13)

## **The battery becomes flat too quickly.**

- When [6K/4K Pre-Burst] or [Pre-Burst Recording] is set, the battery drains faster.
  - Use these functions only when recording with them.

## **The subject is not focused properly.**

- The subject is beyond the focus range of the camera.
- Is [Focus/Release Priority] in the [Custom] menu set to [RELEASE]?
- Is [Shutter AF] in the [Custom] menu set to [OFF]?
- Is the AF Lock applied incorrectly?

**The recorded picture is blurred.  
The Image Stabiliser is not effective.**

- The shutter speed will become slower and the Image Stabiliser function may not work properly when taking pictures especially in dark places.  
→ We recommend using a tripod and the self-timer when taking pictures with a slow shutter speed.

**The subject appears distorted on the picture.**

- If you record a moving subject when using the electronic shutter or recording motion picture or a 6K/4K photo, the subject may appear distorted on the picture. This is characteristic of MOS sensors which serve as the camera's pickup sensors. This is not a malfunction.

**Striping or flicker may appear under lighting such as fluorescent lighting and LED lighting fixture.**

- This is characteristic of MOS sensors which serve as the camera's pickup sensors. This is not a malfunction.
- When using the electronic shutter, lowering the shutter speed may reduce the effect of the horizontal stripes.
- If noticeable flicker or striping is seen under lighting such as a fluorescent or LED lighting fixture when recording motion pictures, set [Fikr Decrease].  
It can reduce the flicker or striping by allowing you to set a fixed shutter speed. You can set the shutter speed manually in the Creative Video Mode. (P23)

**The brightness or the hue of the recorded picture is different from the actual scene.**

- When recording under fluorescent or LED lighting fixture, etc., increasing the shutter speed may introduce slight changes to brightness and colour. These are a result of the characteristics of the light source and do not indicate a malfunction.
- When recording subjects in extremely bright locations or recording under fluorescent lighting, LED lighting fixture, mercury lamp, sodium lighting, etc., the colours and screen brightness may change or horizontal striping may appear on the screen.

**Cannot set [Silent Mode] to [OFF].**

- At the time of purchase, [Silent Mode] is assigned to the function lever. If the function lever is set to [MODE2], change the setting to [MODE1]. (P22)

**Recording motion pictures is not possible.**

- You may not be able to record for a short while after turning this unit on when using a large capacity card.

**Motion picture recording stops in the middle.**

- Depending on the [Rec Format] and [Rec Quality] of a motion picture, the speed class rating required for the card differs. Use a card that meets the rating. (P8)

### **The flash is not activated.**

- When the electronic shutter is used, the flash is not activated.
- When [Silent Mode] is set to [ON], the flash is not activated.

### **The picture is not played back. There are no recorded pictures.**

- Is the card inserted?
- Is this a folder or picture which was processed in the PC?  
If it is, it cannot be played back by this unit.  
→ It is recommended to use the software "PHOTOfunSTUDIO" (P100) to write pictures from PC to card.
- Has [Playback Mode] been set for playback?  
→ Change to [Normal Play].

### **A Wi-Fi connection cannot be established. Radio waves get disconnected. Wireless access point is not displayed.**

#### **■ General tips for using a Wi-Fi connection**

- Use within the communication range of the device to be connected.
- Is any device, such as microwave oven, cordless phone, etc., that uses 2.4 GHz frequency operated nearby?  
→ Radio waves may get interrupted when used simultaneously. Use them sufficiently away from the device.
- When the battery indicator is flashing red, the connection with other equipment may not start or the connection may be disrupted.  
(A message such as [Communication error] is displayed.)
- If you place the camera on a metal table or shelf, the radio waves may be adversely affected. In such cases, you may not be able to establish a connection. Move the camera away from the metal surface.

#### **■ About a wireless access point**

- Check if the wireless access point to connect is in operating state.
- Check the radio wave condition of the wireless access point.  
→ Move this unit closer to the wireless access point.  
→ Change the location and orientation of the wireless access point.
- It may not display even if the radio waves exist depending on the setting of the wireless access point.  
→ Turn off and on the wireless access point.  
→ Check the settings of the wireless access point.  
→ When the network SSID of the wireless access point is set not to broadcast, the wireless access point may not be detected. Enter the network SSID to start the connection or enable the SSID broadcast of the wireless access point.



**When I try to set up a Wi-Fi connection with a Windows 8 PC, my user name and password are not recognised, so I cannot connect to the PC.**

- Some OS versions, including Windows 8, use two types of accounts: a local account and a Microsoft account.  
→ Be sure to use the user name and password for the local account.

**The PC is not recognised when I use a Wi-Fi connection. The camera cannot be connected to PC via Wi-Fi connection.**

- The default workgroup name is set to "WORKGROUP". If you changed the workgroup name, the PC will not be recognised.  
In [PC Connection] of the [Wi-Fi Setup] menu, change the workgroup name to that of the PC you are connecting to.
- Please confirm login name and password are correctly typed.
- When the system time of Mac computer or Windows PC connected to a camera differs severely from that of the camera, the camera cannot be connected to the computer or PC in some OSs.  
→ Please confirm [Clock Set] and [World Time] of the camera matches with time, date and time zone in Windows PC or Mac computer. When both settings do not match severely, please match them.

**It takes time to transmit an image to the web service.  
Transmission of the image fails midway. Some images cannot be transmitted.**

- Is the size of the image too large?  
→ Reduce the image size at [Size], and then send.  
→ Transmit after dividing the motion picture with [Video Divide].
- It may take longer time to transmit when distance to the wireless access point is far.  
→ Transmit closer to the wireless access point.
- File format of the motion picture that can be sent differs depending on the destination.

**There is a sound from lens unit.**

- It is a sound of lens movement or aperture operation when this unit is turned on or off, and it is not a malfunction.
- The sound, which is caused by the automatic adjustment of the aperture, is heard when the brightness has changed due to, for example, zooming or the movement of the camera. This is not a malfunction.

**The camera becomes warm.**

- The surface of the camera and the reverse side of the monitor may become warm during use. This does not affect the performance or quality of the camera.

**The clock is reset.**

- If you do not use the camera for a long time, the clock may be reset.  
→ [Please set the clock] message will be displayed; please reset the clock. (P18)

# Specifications

Specifications are subject to change without notice.

## Digital Camera Body (DC-G9):

Information for your safety

<b>Power Source:</b>	DC 8.4 V (8.4 V <sup>---</sup> )
<b>Power Consumption:</b>	4.0 W (When recording with Monitor) (When the Interchangeable lens (H-ES12060) is used)
	3.0 W (When playing back with Monitor) (When the Interchangeable lens (H-ES12060) is used)

<b>Camera effective pixels</b>	20,330,000 pixels	
<b>Image sensor</b>	4/3" Live MOS sensor, total pixel number 21,770,000 pixels, Primary colour filter	
<b>Digital Zoom</b>	2×/4×	
<b>Extra Tele Conversion</b>	When taking still pictures: Max. 2× (When a picture size of [S] is selected.) When recording motion pictures: 2.7× (FHD)/1.4× (4K)	
<b>Focus mode</b>	AFS/AFF/AFC/MF	
<b>Auto focus mode</b>	Face/Eye Detection/Tracking/225-area-focusing/Custom Multi/1-area-focusing/Pinpoint (Focus area selection is possible by touching or with the joystick)	
<b>Shutter type</b>	Focal-plane shutter	
<b>Burst recording</b>		
<b>Burst speed</b>	Mechanical shutter/ Electronic Front Curtain	12 pictures/second (High speed, AFS/MF), 9 pictures/second (High speed, AFF/AFC), 7 pictures/second (Middle speed), 2 pictures/second (Low speed)
	Electronic shutter	60 pictures/second (Super high speed, AFS/MF), 20 pictures/second (Super high speed, AFF/AFC), 12 pictures/second (High speed, AFS/MF), 9 pictures/second (High speed, AFF/AFC), 7 pictures/second (Middle speed), 2 pictures/second (Low speed)

<b>Number of recordable pictures</b>	Super high speed	When there are RAW files: 50 pictures When there are no RAW files: 50 pictures
	High speed, Middle speed, Low speed	When there are RAW files: 60 or higher pictures When there are no RAW files: 600 or higher pictures * When recording is performed under the test conditions specified by Panasonic
<b>ISO sensitivity (Standard Output Sensitivity)</b>	Still picture: AUTO/ISO/100*/200/400/800/1600/3200/6400/12800/25600 Creative Video Mode: AUTO/100*/200/400/800/1600/3200/6400/12800 (1/3 EV step change possible) * Only available when [Extended ISO] is set.	
<b>Minimum Illumination</b>	Approx. 3 lx (when i-Low light is used, the shutter speed is 1/25th of a second) (When the Interchangeable lens (H-ES12060) is used)	
<b>Shutter speed</b>	Still picture: B (Bulb) (Max. approx. 30 minutes), 60 seconds to 1/8000th of a second (Mechanical shutter), B (Bulb) (Max. approx. 30 minutes), 60 seconds to 1/2000th of a second (Electronic Front Curtain), 1 second to 1/32000th of a second (Electronic shutter) Motion picture: 1/25th of a second to 1/16000th of a second	
<b>Metering range</b>	EV 0 to EV 18	
<b>White Balance</b>	AWB/AWBc/Daylight/Cloudy/Shade/Incandescent lights/Flash/White set1, 2, 3, 4/White Balance K set1, 2, 3, 4	
<b>Exposure (AE)</b>	Programme AE/Aperture-priority AE/Shutter-priority AE/Manual exposure	
<b>Exposure Compensation</b>	1/3 EV Step, -5 EV to +5 EV	
<b>Light metering system, Light metering mode</b>	1728-zone multi-pattern sensing system, Multiple/Centre weighted/Spot	
<b>Monitor</b>	3" TFT LCD (3:2) (Approx. 1,040,000 dots) (field of view ratio about 100%) Touch screen	

<b>Viewfinder</b>	OLED Live Viewfinder (4:3) (Approx. 3,680,000 dots) (field of view ratio about 100%) (Magnification approx. 1.66×, 0.83× (35 mm film camera equivalent), with 50 mm lens at infinity; $-1.0 \text{ m}^{-1}$ ) (with diopter adjustment $-4$ to $+3$ diopter)
<b>Flash Mode</b>	AUTO, AUTO/Red-Eye Reduction, Forced ON, Forced ON/Red-Eye Reduction, Slow Sync., Slow Sync./Red-Eye Reduction, Forced OFF
<b>Flash synchronisation speed</b>	Equal to or smaller than 1/250th of a second
<b>Microphone</b>	Stereo
<b>Speaker</b>	Monaural
<b>Recording media</b>	SD Memory Card/SDHC Memory Card*/SDXC Memory Card* (* Card slot 1/Card slot 2: UHS-I/UHS-II UHS Speed Class 3) Double slot recording function is available.
<b>Picture size</b>	
<b>Still picture</b>	When the aspect ratio setting is [4:3] 4992×3744 pixels (6K photo), 3328×2496 pixels (4K photo), 5184×3888 pixels ([L]), 3712×2784 pixels ([M]), 2624×1968 pixels ([S]), 10368×7776 pixels ([XL])* 7296×5472 pixels ([LL])* When the aspect ratio setting is [3:2] 5184×3456 pixels (6K photo), 3504×2336 pixels (4K photo), 5184×3456 pixels ([L]), 3712×2480 pixels ([M]), 2624×1752 pixels ([S]), 10368×6912 pixels ([XL])* 7296×4864 pixels ([LL])* When the aspect ratio setting is [16:9] 3840×2160 pixels (4K photo), 5184×2920 pixels ([L]), 3840×2160 pixels ([M]), 1920×1080 pixels ([S]), 10368×5832 pixels ([XL])* 7296×4104 pixels ([LL])* When the aspect ratio setting is [1:1] 2880×2880 pixels (4K photo), 3888×3888 pixels ([L]), 2784×2784 pixels ([M]), 1968×1968 pixels ([S]), 7776×7776 pixels ([XL])* 5472×5472 pixels ([LL])* * When recording in [High Resolution Mode]
<b>Recording quality</b>	
<b>Motion pictures</b>	[Rec Format]: [AVCHD]/[MP4] Refer to P64 of this document for details. Refer to P67 of this document for details about High Speed Video.
<b>Quality</b>	RAW/RAW + Fine/RAW + Standard/Fine/Standard

<b>Recording file format</b>	
<b>Still Picture</b>	RAW/JPEG (based on "Design rule for Camera File system", based on "Exif 2.31" standard)
<b>6K/4K photo (burst file)</b>	6K photo: MP4 (H.265/HEVC, AAC (2 ch)) 4K photo: MP4 (H.264/MPEG-4 AVC, AAC (2 ch))
<b>Motion pictures</b>	AVCHD Progressive/AVCHD/MP4
<b>Audio compression</b>	AVCHD                      Dolby Audio™ (2 ch)
	MP4                              AAC (2 ch), LPCM* (2 ch, 48 kHz/16 bit) * When selecting [4K/150M/60p]/[4K/150M/50p]
<b>Interface</b>	
<b>[REMOTE]</b>	∅ 2.5 mm jack
<b>[MIC]</b>	∅ 3.5 mm jack
<b>Headphone</b>	∅ 3.5 mm jack
<b>HDMI</b>	HDMI Type A
<b>USB</b>	Super Speed USB 3.0 GEN1/USB 3.0 Micro-B
<b>Flash synchro</b>	Available
<b>Dimensions</b>	Approx. 136.9 mm (W)×97.3 mm (H)×91.6 mm (D) (5.39" (W)×3.83" (H)×3.61" (D)) (excluding the projecting parts)
<b>Mass</b>	Approx. 658 g/1.45 lb (with one card and the battery) Approx. 586 g/1.30 lb (camera body) Approx. 978 g/2.16 lb (with the Interchangeable lens (H-ES12060), one card and the battery)
<b>Operating temperature</b>	-10 °C* to 40 °C (14 °F* to 104 °F) * The performance of the battery (number of recordable pictures/operating time) may decrease temporarily when using in a temperature between -10 °C and 0 °C (14 °F and 32 °F) (cold places such as ski resorts or places at high altitude).

<b>Operating humidity</b>	10%RH to 80%RH
<b>Dust-proof and splash-proof</b>	Yes

**Wireless transmitter**

<b>Wireless LAN</b>	
<b>Compliance standard</b>	IEEE 802.11a/b/g/n/ac (standard wireless LAN protocol)
<b>Frequency range used (central frequency)</b>	2412 MHz to 2472 MHz (1 to 13 ch) 5180 MHz to 5320 MHz (36/40/44/48/52/56/60/64 ch) 5500 MHz to 5700 MHz (100/104/108/112/116/132/136/140 ch) 5745 MHz to 5825 MHz (149/153/157/161/165 ch)
<b>Encryption method</b>	Wi-Fi compliant WPA™/WPA2™
<b>Access method</b>	Infrastructure mode
<b>Bluetooth function</b>	
<b>Compliance standard</b>	Bluetooth v4.2 (Bluetooth low energy (BLE))
<b>Frequency range used (central frequency)</b>	2402 MHz to 2480 MHz

**Battery Charger (Panasonic DMW-BTC13):**

Information for your safety

<b>Input:</b>	5.0 V $\equiv$ 1.8 A
<b>Output:</b>	8.4 V $\equiv$ 0.85 A
<b>Operating temperature:</b>	0 °C to 40 °C (32 °F to 104 °F)

**AC adaptor (Panasonic VSK0815M):**

Information for your safety

<b>Input:</b>	110 V – 240 V $\sim$ 50/60 Hz 0.25 A
<b>Output:</b>	5.0 V $\equiv$ 1.8 A
<b>Operating temperature:</b>	0 °C to 40 °C (32 °F to 104 °F)

**Battery Pack (lithium-ion) (Panasonic DMW-BLF19E):**

Information for your safety

<b>Voltage/capacity:</b>	7.2 V/1860 mAh
--------------------------	----------------

The symbols on this product (including the accessories) represent the following:

$\sim$	AC
$\equiv$	DC
$\square$	Class II equipment (The construction of the product is double-insulated.)

<b>Interchangeable Lens</b>	<b>H-ES12060</b> “LEICA DG VARIO-ELMARIT 12–60 mm/F2.8–4.0 ASPH./ POWER O.I.S.”
<b>Focal length</b>	f=12 mm to 60 mm (35 mm film camera equivalent: 24 mm to 120 mm)
<b>Aperture type</b>	9 diaphragm blades/circular aperture diaphragm
<b>Maximum aperture</b>	F2.8 (Wide) to F4.0 (Tele)
<b>Minimum aperture value</b>	F22
<b>Lens construction</b>	14 elements in 12 groups (4 aspherical lenses, 2 ED lenses)
<b>Nano surface coating</b>	Yes
<b>In focus distance</b>	Wide: 0.2 m (0.66 feet) to ∞ / Tele: 0.24 m (0.79 feet) to ∞ (from the focus distance reference line)
<b>Maximum image magnification</b>	0.3× (35 mm film camera equivalent: 0.6×)
<b>Optical Image Stabiliser</b>	Available
<b>O.I.S. switch</b>	Available (Switching ON/OFF)
<b>[AF/MF] switch</b>	Available (Switching AF/MF)
<b>Mount</b>	“Micro Four Thirds Mount”
<b>Angle of view</b>	84° (Wide) to 20° (Tele)
<b>Filter diameter</b>	62 mm
<b>Max. diameter</b>	Ø68.4 mm (2.7 inch)
<b>Overall length</b>	Approx. 86 mm (3.4 inch) (from the tip of the lens to the base side of the lens mount)
<b>Mass</b>	Approx. 320 g/0.70 lb
<b>Operating temperature</b>	–10 °C to 40 °C (14 °F to 104 °F)
<b>Dust-proof and splash-proof</b>	Yes

- LEICA is a registered trademark of Leica Microsystems IR GmbH. ELMARIT is a registered trademark of Leica Camera AG. The LEICA DG lenses are manufactured using measurement instruments and quality assurance systems that have been certified by Leica Camera AG based on the company's quality standards.

# Digital Camera Accessory System

Description	Accessory#
Battery Pack	DMW-BLF19
Battery Charger*1	DMW-BTC13
AC Adaptor*2	DMW-AC10
DC Coupler*2	DMW-DCC12
LED Video Light	VW-LED1
Flash	DMW-FL580L, DMW-FL360L, DMW-FL200L
Stereo Shotgun Microphone	DMW-MS2
Stereo Microphone	VW-VMS10
Shutter Remote Control	DMW-RSL1
Battery Grip	DMW-BGG9
Eye Cup	DMW-EC4
Shoulder Strap	DMW-SSTG9
Body Cap	DMW-BDC1
Tripod Adaptor*3	DMW-TA1
Mount Adaptor	DMW-MA1, DMW-MA2M, DMW-MA3R

\*1 Supplied with an AC adaptor and a USB connection cable (for charger).

\*2 The AC Adaptor (optional) can only be used with the designated Panasonic DC Coupler (optional). The AC adaptor (optional) cannot be used by itself.

\*3 Use if the attached lens is in contact with the tripod pedestal.

Product numbers correct as of November 2017. These may be subject to change.

- Some optional accessories may not be available in some countries.
- NOTE: Accessories and/or model numbers may vary between countries. Consult your local dealer.
- For lens-related optional accessories such as compatible lenses and filters, refer to catalogues/ Web pages, etc.



# Reading the Operating Instructions (PDF format)

More detailed operating instructions are available in "Operating Instructions for advanced features (PDF format)". To read it, download it from the website.

<http://panasonic.jp/support/dsc/oi/index.html?model=DC-G9&dest=GN>

- Click the desired language.



## ■ To check the URL and QR code on the camera

**MENU** →  **[Setup]** → **[Online Manual]**

<b>[URL display]</b>	Displays the URL of the website on the camera's monitor.
<b>[QR Code display]</b>	Displays the QR code on the camera's monitor.

- You will need Adobe Reader to browse or print the "Operating Instructions for advanced features (PDF format)".

You can download and install a version of Adobe Reader that you can use with your OS from the following website. (As of November 2017)

<http://www.adobe.com/products/acrobat/readstep2.html>

This product incorporates the following software:

- (1) the software developed independently by or for Panasonic Corporation,
- (2) the software owned by third party and licensed to Panasonic Corporation,
- (3) the software licensed under the GNU General Public License, Version 2.0 (GPL V2.0),
- (4) the software licensed under the GNU LESSER General Public License, Version 2.1 (LGPL V2.1), and/or
- (5) open source software other than the software licensed under the GPL V2.0 and/or LGPL V2.1.

The software categorised as (3) - (5) are distributed in the hope that it will be useful, but WITHOUT ANY WARRANTY, without even the implied warranty of MERCHANTABILITY or FITNESS FOR A PARTICULAR PURPOSE. Please refer to the detailed terms and conditions thereof displayed by selecting [MENU/SET] → [Setup] → [Version Disp.] → [Software info].

At least three (3) years from delivery of this product, Panasonic will give to any third party who contacts us at the contact information provided below, for a charge no more than our cost of physically performing source code distribution, a complete machine-readable copy of the corresponding source code covered under GPL V2.0 or LGPL V2.1, as well as the respective copyright notice thereof.

Contact Information: [oss-cd-request@gg.jp.panasonic.com](mailto:oss-cd-request@gg.jp.panasonic.com)

The source code and the copyright notice are also available for free in our website below.  
<https://panasonic.net/cns/oss/index.html>

# Limited Warranty (ONLY FOR AUSTRALIA)

## Panasonic Warranty

- The product is warranted for 12 months from the date of purchase. Subject to the conditions of this warranty Panasonic or its Authorised Service Centre will perform necessary service on the product without charge for parts or labour, if in the opinion of Panasonic, the product is found to be faulty within the warranty period.
- This warranty only applies to Panasonic products purchased in Australia and sold by Panasonic Australia or its Authorised Distributors or Dealers and only where the products are used and serviced within Australia or its territories. Warranty cover only applies to service carried out by a Panasonic Authorised Service Centre and only if valid proof of purchase is presented when warranty service is requested.
- This warranty only applies if the product has been installed and used in accordance with the manufacturer's recommendations (as noted in the operating instructions) under normal use and reasonable care (in the opinion of Panasonic). The warranty covers normal domestic use only and does not cover damage, malfunction or failure resulting from use of incorrect voltages, incorrect installation, accident, misuse, neglect, build-up of dirt or dust, abuse, maladjustment of customer controls, mains supply problems, thunderstorm activity, infestation by insects or vermin, tampering or repair by unauthorised persons (including unauthorised alterations), introduction of sand, humidity or liquids, commercial use such as hotel, office, restaurant, or other business or rental use of the product, exposure to abnormally corrosive conditions or any foreign object or matter having entered the product.
- This warranty does not cover the following items unless the fault or defect existed at the time of purchase:
 

(a) Cabinet Part(s)	(e) DVD, Blu-ray or Recordable Discs
(b) Video or Audio Tapes	(f) Video / Audio Heads from wear and tear in normal use
(c) SD cards or USB devices	(g) Information stored on Hard Disk Drive, USB stick or SD card
(d) User replaceable Batteries etc	(h) DTV reception issues caused by TV Aerial / Cabling / Wall socket(s)
- Some products may be supplied with Ethernet connection hardware. The warranty is limited on such products and will not cover:
  - Internet and or DLNA connection / setup related problems
  - Access fees and or charges incurred for internet connection
  - The use of incompatible software or software not specifically stipulated in the product operations manual; and
  - Any indirect or consequential costs associated with the incorrect use or misuse of the hardware, its connection to the internet or any other device.
- To claim warranty service, when required, you should:
  - Telephone Panasonic's Customer Care Centre on 132600 or visit our website referred to below and use the Service Centre Locator for the name/address of the nearest Authorised Service Centre.
  - Send or take the product to a Panasonic Authorised Service Centre together with your proof of purchase receipt as a proof of purchase date. Please note that freight and insurance to and / or from your nearest Authorised Service Centre must be arranged by you.
  - Note that home or pick-up/delivery service is available for the following products in the major metropolitan areas of Australia or the normal operating areas of the nearest Authorised Service Centres:
    - Plasma/LCD televisions / displays (screen size greater than 103 cm)
- The warranties hereby conferred do not extend to, and exclude, any costs associated with the installation, de-installation or re-installation of a product, including costs related to the mounting, de-mounting or remounting of any screen, (and any other ancillary activities), delivery, handling, freight, transportation or insurance of the product or any part thereof or replacement of and do not extend to, and exclude, any damage or loss occurring by reason of, during, associated with, or related to such installation, de-installation, re-installation or transit.

Panasonic Authorised Service Centres are located in major metropolitan areas and most regional centres of Australia, however, coverage will vary dependant on product. For advice on exact Authorised Service Centre locations for your product, please telephone our Customer Care Centre on 132600 or visit our website and use the Service Centre Locator.

In addition to your rights under this warranty, Panasonic products come with consumer guarantees that cannot be excluded under the Australian Consumer Law. If there is a major failure with the product, you can reject the product and elect to have a refund or to have the product replaced or if you wish you may elect to keep the goods and be compensated for the drop in value of the goods. You are also entitled to have the product repaired or replaced if the product fails to be of acceptable quality and the failure does not amount to a major failure.

If there is a major failure in regard to the product which cannot be remedied then you must notify us within a reasonable period by contacting the Panasonic Customer Care Centre. If the failure in the product is not a major failure then Panasonic may choose to repair or replace the product and will do so in a reasonable period of time from receiving notice from you.

**THIS WARRANTY CARD AND THE PURCHASE DOCKET (OR SIMILAR PROOF OF PURCHASE) SHOULD BE RETAINED BY THE CUSTOMER AT ALL TIMES**

If you require assistance regarding warranty conditions or any other enquiries, please visit the **Panasonic Australia** website [www.panasonic.com.au](http://www.panasonic.com.au) or contact by phone on **132 600** *If phoning in, please ensure you have your operating instructions available.*

**Panasonic Australia Pty. Limited**

ACN 001 592 187 ABN 83 001 592 187  
1 Innovation Road, Macquarie Park NSW 2113

PRO-031-F11 Issue: 4.0

01-01-2011

- G MICRO SYSTEM is a lens exchange type digital camera system of LUMIX based on a Micro Four Thirds System standard.
- Micro Four Thirds™ and Micro Four Thirds Logo marks are trademarks or registered trademarks of Olympus Corporation, in Japan, the United States, the European Union and other countries.
- Four Thirds™ and Four Thirds Logo marks are trademarks or registered trademarks of Olympus Corporation, in Japan, the United States, the European Union and other countries.
- SDXC Logo is a trademark of SD-3C, LLC.
- The terms HDMI and HDMI High-Definition Multimedia Interface, and the HDMI Logo are trademarks or registered trademarks of HDMI Licensing Administrator, Inc. in the United States and other countries.
- “AVCHD”, “AVCHD Progressive” and the “AVCHD Progressive” logo are trademarks of Panasonic Corporation and Sony Corporation.
- Dolby, Dolby Audio, and the double-D symbol are trademarks of Dolby Laboratories.
- HDAVI Control™ is a trademark of Panasonic Corporation.
- Adobe is a trademark or registered trademark of Adobe Systems Incorporated in the United States and/or other countries.
- Pentium is a trademark of Intel Corporation in the U.S. and/or other countries.
- Windows is a registered trademark or trademark of Microsoft Corporation in the United States and/or other countries.
- iMovie, Mac, OS X and macOS are trademarks of Apple Inc., registered in the U.S. and other countries.
- iPad, iPhone, iPod, and iPod touch are trademarks of Apple Inc., registered in the U.S. and other countries.
- App Store is a service mark of Apple Inc.
- Android and Google Play are trademarks or registered trademarks of Google Inc.
- The Bluetooth® word mark and logos are registered trademarks owned by the Bluetooth SIG, Inc. and any use of such marks by Panasonic Corporation is under license. Other trademarks and trade names are those of their respective owners.



- The Wi-Fi CERTIFIED™ Logo is a certification mark of Wi-Fi Alliance®.
- The Wi-Fi Protected Setup™ Logo is a certification mark of Wi-Fi Alliance®.
- “Wi-Fi®” is a registered trademarks of Wi-Fi Alliance®.
- “Wi-Fi Protected Setup™”, “WPA™”, and “WPA2™” are trademarks of Wi-Fi Alliance®.
- DLNA, the DLNA Logo and DLNA CERTIFIED are trademarks, service marks, or certification marks of the Digital Living Network Alliance.
- This product uses “DynaFont” from DynaComware Corporation. DynaFont is a registered trademark of DynaComware Taiwan Inc.
- QR Code is a registered trademark of DENSO WAVE INCORPORATED.
- Other names of systems and products mentioned in these instructions are usually the registered trademarks or trademarks of the manufacturers who developed the system or product concerned.



This product is licensed under the AVC Patent Portfolio License for the personal use of a consumer or other uses in which it does not receive remuneration to (i) encode video in compliance with the AVC Standard (“AVC Video”) and/or (ii) decode AVC Video that was encoded by a consumer engaged in a personal activity and/or was obtained from a video provider licensed to provide AVC Video. No license is granted or shall be implied for any other use. Additional information may be obtained from MPEG LA, L.L.C.

See <http://www.mpegla.com>