

Panasonic[®]

Operating Instructions for advanced features

Digital Camera

Model No. **DC-G90**



LUMIX

Please read these instructions carefully before using this product,
and save this manual for future use.

Message Display P318

Troubleshooting P321

Finding the information you need P2

Contents P4

Contents by Function P10

Menu Guide P192

DVQP2782ZA







F0422AJ0



Finding the information you need

In this “Operating Instructions for advanced features”, you can find the information you need from the following pages.

By clicking a page number, you can jump to the linked page and quickly find the information.

 1	Search from “Contents”	P4
 2	 2 Click this icon to jump to “Contents”.	
 3	Search from the list of function names	P10
 4	Search from the list of buttons and dials	P16
	Search from the list of screens and icons	P311
	Search from “Message Display”	P318
 3	Search from “Menu Guide”	P192
	Search from “Troubleshooting”	P321



1

Click this icon to jump to “Finding the information you need”.



4

Click this icon to return to the previously displayed page.

How to use this manual

About the indication of the applicable mode

Applicable modes: 

The icons indicate the modes available for a function.

- Black icons: Applicable modes
- Grey icons: Unavailable modes

C1 and **C2** will differ depending on the Recording Modes registered under custom settings.

About the symbols in the text

MENU: Indicates that the menu can be set by pressing [MENU/SET] button.



Wi-Fi: Indicates that the Wi-Fi setting can be made by pressing [Wi-Fi] button.



: Tips for skilful use and points for recording.

: Conditions in which a particular function cannot be used.

- Click a cross reference in the text to jump to the corresponding page.

Steps for setting a menu item are described as follows.

Example: In the [Rec] menu, change [Quality] from  to .

MENU →  **[Rec]** → **[Quality]** → 

- Description in these operating instructions is based on the interchangeable lens (H-FS12060).

Contents

Finding the information you need	2
How to use this manual	3
Contents by Function	10

1. Before Use

Care of the camera	13
Standard Accessories	15
Names and Functions of Components	16
About the Lens	19

2. Getting Started/Basic Operations

Attaching the Shoulder Strap	20
Charging the Battery	21
• Charge the battery using the battery charger	21
• Battery Insertion	22
• Charge the battery using the camera	24
• Number of pictures and recordable time	27
Inserting the Card (Optional)	30
Card Information	32
• Formatting the card (initialisation)	33
• Number of Recordable Pictures, Recordable Time	33
Attaching a Lens	35
Changing the Monitor Position	38
Setting the Clock (When Turning On for the First Time)	39
Basic Operations	41
• How to Hold the Camera	41
• Using the Viewfinder	42
• Shutter button (Taking pictures)	43
• Motion picture button (Recording motion pictures)	44
• Mode dial (Selecting a Recording Mode)	44
• Front Dial/Rear Dial	45
• Control Dial	47
• Cursor buttons/[MENU/SET] button	48
• [DISP.] button (switching the information display)	48
• Touch screen (Touch operations)	52
• Taking Pictures Using the Touch Function	53
Setting menu items	55
Quick Menu	58
• Customising the Quick Menu settings	59
Fn Buttons	60
Entering Text	64

3. Recording Modes

Easy Recording (Intelligent Auto Mode).....	65
• [Intelligent Auto] menu.....	68
• Taking pictures with customised colour, defocus control, and brightness settings.....	69
Programme AE Mode	71
Taking Pictures by Specifying the Aperture/Shutter Speed	72
• Aperture-Priority AE Mode	73
• Shutter-Priority AE Mode.....	73
• Manual Exposure Mode	74
• Bulb recording	75
• Live View Composite Recording.....	76
• Preview Mode.....	78
• One Push AE.....	79
Custom Mode.....	80
• Registering custom settings	80
• Using Custom Mode	81
Scene Guide Mode	82
• [Panorama Shot]	85
Creative Control Mode	87
• Types of image effects.....	88

4. Focus, Brightness (Exposure) and Colour tone Settings

Using AF	93
• Setting the Focus Mode (AFS/AFF/AFC).....	95
• [AF Sensitivity(Photo)].....	96
Selecting the AF Mode.....	97
• AF area movement operation	102
• Specifying the AF area position with the Touch Pad	105
• Adjusting focus and brightness for the touched position	106
Record Using MF	107
Locking Focus and Exposure (AF/AE Lock)	110
Exposure Compensation.....	111
Setting the ISO Sensitivity	113
Setting the White Balance (WB).....	115
• Finely adjusting the White Balance	117

5. 4K Photo and Drive Settings

Select a Drive Mode.....	118
Taking Pictures using Burst Mode.....	119
4K Photo Recording.....	122
• Notes on the 4K Photo function.....	125
Selecting pictures from 4K burst file.....	128
• Operations during selecting pictures.....	129
Post Focus Recording.....	133
• Selecting the Focus Position for the Picture to Save.....	135
• Focus Stacking.....	136
Taking Pictures with Time Lapse Shot/ Stop Motion Animation.....	138
• [Time Lapse Shot].....	138
• Recording with Stop Motion Animation.....	140
• Motion pictures using Time Lapse Shot/Stop Motion Animation.....	142
Recording Using the Self-timer.....	143
Bracket Recording.....	144
• Exposure Bracket.....	145
• Aperture Bracket.....	146
• Focus Bracket.....	146
• White Balance Bracket.....	147

6. Stabiliser, Zoom and Flash

Image Stabiliser.....	148
• Image Stabiliser Settings.....	150
• Setting the focal length of a lens.....	151
Taking Pictures with the Zoom.....	153
• Optical zoom.....	153
• Raising the telescopic effect.....	154
• Zooming using touch operations (Touch zoom).....	158
Using a Flash.....	159
Setting Flash Functions.....	161
• [Firing Mode]/[Manual Flash Adjust.].....	161
• [Flash Mode].....	162
• [Flash Synchro].....	164
• Adjusting the Flash Output.....	165
• [Auto Exposure Comp.].....	165
Recording Using a Wireless Flash.....	166
• Using other settings for wireless flash recording.....	168

7. Recording Motion Pictures

Recording Motion Picture.....	169
• [Rec Format]/[Rec Quality]	171
• [Continuous AF].....	172
• [AF Custom Setting(Video)].....	173
• Log recording (V-Log L).....	174
• Recording still pictures while recording motion pictures.....	175
• [Snap Movie]	176
• Displaying/Setting the Sound Recording Level	179
Creative Video Mode.....	180
• [High Speed Video].....	181
• [4K Live Cropping].....	182

8. Playing Back and Editing Images

Playing Back Pictures	184
Playing Back Motion Pictures.....	185
• Extracting a Picture	186
Switching the Display Mode.....	187
• Enlarged Display	187
• Thumbnail Screen	187
• Calendar Playback	188
Group Images	189
Deleting Images	191

9. Menu Guide

Menus that are only available for particular Recording Modes	192
[Rec] menu.....	193
[Motion Picture] menu	210
[Custom] menu.....	213
[Setup] menu.....	228
[My Menu] menu	238
[Playback] menu	239

10. Using the Wi-Fi/Bluetooth function

What you can do with the Wi-Fi®/Bluetooth® function	256
Wi-Fi function/Bluetooth function	257
Connecting to a smartphone	259
• Installing "Panasonic Image App"	259
• Connecting to a Smartphone (Bluetooth Connection)	260
• Connecting to a Smartphone (Wi-Fi connection)	262
• Changing the Wi-Fi connection method	264
• Terminating the Wi-Fi connection	265
Operating the Camera with a Smartphone	266
• Camera power operations	266
• Remote shooting	267
• [Shutter Remote Control]	268
• Playing back/saving recorded images	270
• Transferring recorded images automatically	271
• Recording location information	273
• Automatically setting the clock	274
• Editing motion pictures recorded with Snap Movie	275
Displaying pictures on a TV	276
Sending images from the camera	277
Sending images to a smartphone	280
Printing Wirelessly	281
Sending images to AV device	282
Sending images to PC	283
Wi-Fi connections	285
• [Via Network]	286
• [Direct]	288
• Connect to Wi-Fi Using Previously Saved Settings	289
[Wi-Fi Setup] Menu	291

11. Connecting to other devices

Watching/Saving 4K Motion Pictures on an External Device	293
• Watching motion pictures in 4K	293
• Storing 4K motion pictures	293
Playing Back Pictures on a TV Screen	294
• Recording while monitoring camera images	295
• Using VIERA Link (HDMI)	296
Importing images to a PC	297
• Downloading software	298
• Copying images to a PC	300
Storing on a Recorder	302
Printing the Pictures	303
• Adding date and text to pictures	305

12. Others

Optional accessories	306
Monitor Display/Viewfinder Display	311
Message Display	318
Troubleshooting	321
Cautions for Use	330

Contents by Function



Recording

Recording

Recording Mode	P44
[Preview]	P78
Bulb recording	P75
[Live View Composite]	P76
[Panorama Shot]	P85
[Time Lapse Shot]	P138
[Stop Motion Animation]	P140
Bracket Recording	P144
[Silent Mode]	P206
[Multi Exp.]	P209

4K photo

4K Photo Recording	P122
Post Focus Recording	P133

Focus (AF/MF)

AF	P93
[Focus Mode]	P95
[AF Sensitivity(Photo)]	P96
[AF Mode]	P97
Adjusting the AF area position	P102
MF	P107
[AF/AE Lock]	P110

Drive

[Drive Mode]	P118
[Burst]	P119
[Self Timer]	P143

Picture Quality and Colour Tone

[White Balance]	P115
[Picture Size]	P194
[Quality]	P195
[Photo Style]	P196
[Filter Settings]	P199
[Color Space]	P200
[Highlight Shadow]	P201
[i.Dynamic]	P202
[i.Resolution]	P203
[Long Shtr NR]	P204
[Shading Comp.]	P205
[Diffraction Compensation]	P205
[HDR]	P208

Exposure

[Touch AE]	P54
[One Push AE]	P79
[AF/AE Lock]	P110
Exposure Compensation	P111
[Sensitivity]	P113
Exposure Bracket	P145
[Metering Mode]	P201

Stabiliser

Dual I.S.	P148
5-Axis Hybrid Image Stabiliser	P149

Flash

[Flash Mode]	P162
[Flash Synchro]	P164
[Flash Adjust.]	P165
Wireless flash settings	P166

**Motion Picture****Motion Picture**

[Rec Format]/[Rec Quality]	P171
Recording still pictures while recording motion pictures	P175
[Snap Movie]	P176

Creative Video Mode

[High Speed Video]	P181
[4K Live Cropping]	P182

Audio

[Sound Rec Level Adj.]	P179
[Sound Rec Level Limiter]	P179
[Wind Cut]	P310
[Wind Noise Canceller]	P211
[Lens Noise Cut]	P211

Monitoring

HDMI output during recording	P295
[Sound Output]	P212

Screen settings

[Sound Rec Level Disp.]	P179
[Monochrome Live View]	P219
[Center Marker]	P221
[Zebra Pattern]	P222

Advanced recording

Log recording (V-Log L)	P174
-------------------------------	------

**Setup/Custom****Basic settings**

[Format]	P33
[Clock Set]	P39
Adjusting the Viewfinder Dioptre	P42
[Q.MENU]	P58
[Beep]	P230
[Economy]	P231
[Reset] (initialisation)	P236
[Sensor Cleaning]	P237

Customisation

Fn buttons	P60
Custom Mode	P80
[Custom] menu	P213

**Playback****Playback**

Picture playback	P184
Motion picture playback	P185
Playback Zoom	P187
Thumbnail Screen	P187
Delete	P191
[Auto Review]	P219
[Slide Show]	P240
[Rotate]/[Rotate Disp.]	P253, 254

Edit

[4K PHOTO Bulk Saving]	P128
Post Focus	P133
Focus Stacking	P136
[Title Edit]	P243
[RAW Processing]	P244
[Light Composition]	P247
[Sequence Composition]	P248
[Clear Retouch]	P249
[Text Stamp]	P250
[Resize]	P251
[Cropping]	P252

Image settings

[Protect]	P242
[Rating]	P242

**Wi-Fi/Bluetooth****Image App**

"Image App"	P259
[Remote Wakeup]	P266
Remote recording	P267
[Auto Transfer]	P271

In combination with other devices

Playing back pictures on a TV	P276
Printing images	P281
Sending images to an AV device	P282
Sending images to a PC	P283

**Connections with other devices****PC**

"PHOTOfunSTUDIO"	P298
"SILKYPIX Developer Studio"	P299
Transferring images to a PC	P300

Recorder

Dubbing	P302
---------------	------

Printer

PictBridge	P303
------------------	------

TV

Playing Back Pictures on a TV Screen	P294
[VIERA Link]	P296

Care of the camera

■ Firmware of Your Camera/Lens

Firmware updates may be provided in order to improve camera capabilities or to add functionality. For smoother recording, we recommend updating the firmware of the camera/lens to the latest version.

- For the latest information on the firmware or to download/update the firmware, visit the following support website:

<https://panasonic.jp/support/global/cs/dsc/>

(English only)

- To check the firmware version of the camera/lens, attach the lens to the camera.

■ Handling of the Camera

Do not subject the camera to strong vibration, impacts, or pressure.

These may cause a malfunction or damage.

- Do not drop or knock against hard surfaces.
- Do not push hard on the lens section or monitor.

If sand, dust, or liquid gets on the monitor, wipe it off with a dry soft cloth.

- If the monitor is closed when such liquids are present, malfunction may result.
- Touch operations may be incorrectly recognised.

Do not place a hand inside the camera mount.

This may cause a failure or damage because the sensor is a precision device.

If you shake the camera while turning the camera off, a sensor may operate or a rattling sound may be heard. This is caused by the image stabiliser mechanism in the body. It is not a malfunction.

■ Splash Resistant

Splash Resistant is a term used to describe an extra level of protection this camera offers against exposure to a minimal amount of moisture, water or dust. Splash Resistant does not guarantee that damage will not occur if this camera is subjected to direct contact with water.

In order to minimise the possibility of damage please be sure the following precautions are taken:

- Splash Resistant works in conjunction with the lenses that were specifically designed to support this feature.
- Securely close the doors, socket caps, contact points cover, flash, etc.
- When the lens or cap is removed or a door is open, do not allow sand, dust, and moisture to enter inside.
- If liquid gets on the camera, wipe it off with a dry soft cloth.

■ **Condensation (When the Lens, the Viewfinder or Monitor is Fogged Up)**

- Condensation occurs when there are temperature or humidity differences. Be careful because condensation can lead to stains or mould on the lens, viewfinder, and monitor or cause a failure.
- If condensation occurs, turn off the camera and leave it for approx. 2 hours. The fog will disappear naturally when the temperature of the camera becomes close to the ambient temperature.

■ **Be Sure to Perform Trial Recording in Advance**

Perform trial recording in advance of an important event (wedding, etc.) to check that recording can be performed normally.

■ **No Compensation Regarding Recording**

Please note that compensation cannot be provided in the event that recording could not be performed due to a problem with the camera or a card.

■ **Be Careful with Regard to Copyrights**

Under copyright law, you may not use the images and audio you have recorded for other than personal enjoyment without the permission of the copyright holder.

Be careful because there are cases where restrictions apply to recording even for the purpose of personal enjoyment.

■ **Also Read “Cautions for Use” (P330)**



MENU



Standard Accessories

Check that all the accessories are supplied before using the camera.

- The accessories and their shape will differ depending on the country or area where the camera was purchased.
For details on the accessories, refer to “Basic Operating Instructions”.
- Digital Camera Body is indicated as **camera body** in the text.
- Battery Pack is indicated as **battery pack** or **battery** in the text.
- Battery Charger is indicated as **battery charger** or **charger** in the text.
- Interchangeable Lens is indicated as **lens** in the text.
- SD Memory Card, SDHC Memory Card and SDXC Memory Card are indicated as **card** in the text.
- **The card is optional.**

Names and Functions of Components

■ Camera body

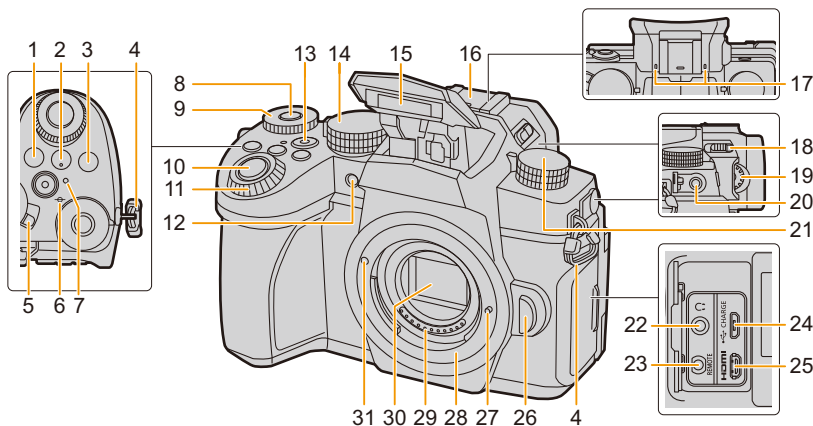

1 [WB] (White Balance) button (P115)	17 Stereo microphone (P179) • Be careful not to cover the microphone with your finger. Doing so may make sound difficult to record.
2 [ISO] (ISO sensitivity) button (P113)	18 [⚡] (Flash open lever) (P159) • The flash opens, and recording with the flash becomes possible.
3 [⏏] (Exposure Compensation) button (P111)	19 Dioptre adjustment dial (P42)
4 Shoulder strap eyelet (P20)	20 [MIC] socket (P309)
5 Camera ON/OFF switch (P39)	21 Drive mode dial (P118)
6 [-∞] (Focus distance reference mark) (P109)	22 Headphone socket (P212)
7 Charging lamp (P24)/ WIRELESS connection lamp (P257)	23 [REMOTE] socket (P308)
8 Dial operation switch button (P46)/ Fn button (Fn1) (P60)	24 [USB/CHARGE] socket (P24, 300, 302, 303)
9 Rear dial (P45)	25 [HDMI] socket (P294)
10 Shutter button (P43)	26 Lens release button (P36)
11 Front dial (P45)	27 Lens lock pin
12 Self-timer indicator (P143)/ AF Assist Lamp (P215)	28 Mount
13 Motion picture button (P169)	29 Contact points
14 Mode dial (P44)	30 Sensor
15 Flash (P159)	31 Lens fitting mark (P35)
16 Hot shoe (Hot shoe cover) (P306) • Keep the hot shoe cover out of reach of children to prevent swallowing.	

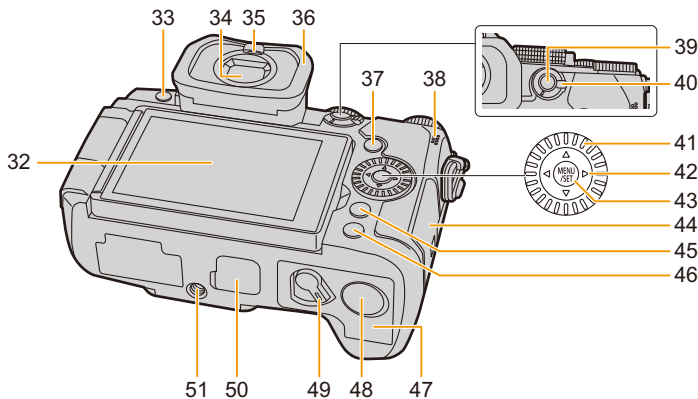

32 Touch screen (P52)/monitor (P311)	45 [Q.MENU] button (P58)/[Fn2] button (P60)/ [] (Delete) button (P191)/ [] (Cancel) button (P57)
33 [LVF] button (P42)/[Fn3] button (P60)	46 [DISP.] button (P48)
34 Viewfinder (P42, 331)	47 Battery door (P22)
35 Eye sensor (P42)	48 DC coupler cover (P310) • When using an AC adaptor, ensure that the Panasonic DC coupler (optional) and AC adaptor (optional) are used.
36 Eye cup	49 Release lever (P22)
37 [] (Playback) button (P184)	50 Cover for the battery grip connector (P307) • Keep the cover for the battery grip connector out of reach of children to prevent swallowing.
38 Speaker (P230)	51 Tripod mount (P335) • It may not be possible to attach and securely fasten a tripod with a screw length of 5.5 mm (0.22 inch) or more to the camera. Doing so may also damage the camera.
39 [AF/AE LOCK] button (P110)	
40 Focus mode lever (P93, 95, 107)	
41 Control dial (P47) Cursor buttons (P48)/ ▲ Fn button (Fn9) (P60) ▶ Fn button (Fn10) (P60) ▼ Fn button (Fn11) (P60) ◀ [] (AF Mode) button (P93)	
43 [MENU/SET] button (P48, 55)	
44 Card door (P30)	

• **Fn buttons ([Fn4] to [Fn8]) are touch icons.**

Touch the [Fn] tab on the recording screen to display them.

■ Lens

H-FS12060

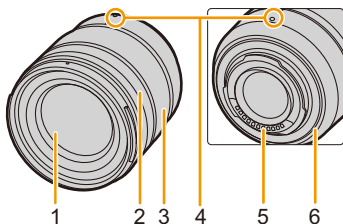

H-FSA14140

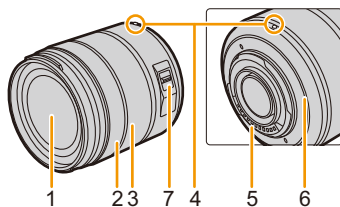

H-FS1442A

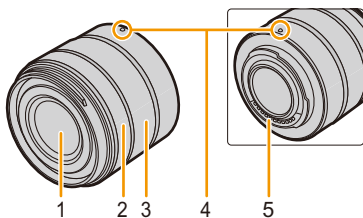

- | | |
|---|--------------------------|
| 1 | Lens surface |
| 2 | Focus ring (P107) |
| 3 | Zoom ring (P153) |
| 4 | Lens fitting mark (P35) |
| 5 | Contact points |
| 6 | Lens mount rubber (P332) |
| 7 | O.I.S. switch (P148) |

About the Lens

This unit can use the dedicated lenses compatible with the Micro Four Thirds™ System lens mount specification (Micro Four Thirds mount).

You can also use a lens of any of the following standards by attaching a mount adaptor.



Lens	Mount adaptor
Four Thirds™ mount specification lens 	Mount Adaptor (DMW-MA1: optional)
Leica M Mount interchangeable lens	M Mount Adaptor (DMW-MA2M: optional)
Leica R Mount interchangeable lens	R Mount Adaptor (DMW-MA3R: optional)

■ About the lens and functions

Depending on the lens used, certain functions, such as AF, Image Stabiliser, and zoom functions, may be disabled or operate differently.

- Refer to catalogues/websites for most current information regarding supported lenses.

<https://panasonic.ip/support/global/cs/dsc/>

(This Site is English only.)

- The focal lengths marked on a Micro Four Thirds lens are equivalent to twice those of a 35 mm film camera. (The focal lengths will be equivalent to those of a 100 mm lens in 35 mm terms when a 50 mm lens is used.)

Attaching the Shoulder Strap

We recommend attaching the shoulder strap when using the camera to prevent it from dropping.

- 1 Pass the shoulder strap through the shoulder strap eyelet on the camera body.

(A): Shoulder strap eyelet

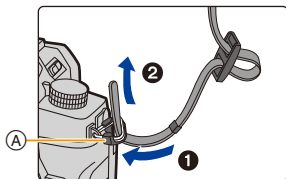

- 2 Pass the end of the shoulder strap through the ring in the direction of the arrow and then pass it through the stopper.

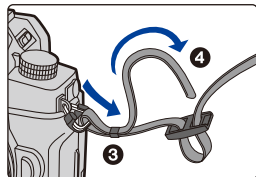

- 3 Pass the end of the shoulder strap through the hole on the other side of the stopper.

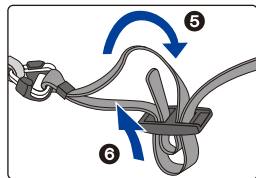

- 4 Pull the shoulder strap and then check that it will not come out.

- Perform steps 1 to 4 and then attach the other side of the shoulder strap.

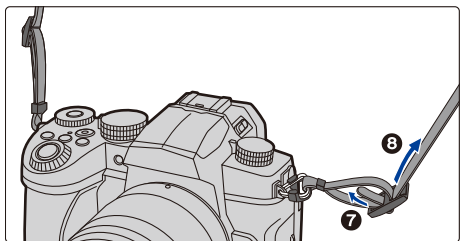

- Use the shoulder strap around your shoulder.
 - Do not wrap the strap around your neck. It may result in injury or accident.
 - Do not leave the shoulder strap where an infant can reach it. It may result in an accident by mistakenly wrapping around the neck.

Charging the Battery

You can charge the battery either using the supplied charger, or in the camera body. If you turn on the camera, you can also power it from a power outlet.

- The battery is not charged when the camera is shipped. Charge the battery before use.

Charge the battery using the battery charger

Charging time

Approx. 175 min

- Use the supplied charger and AC adaptor.
- The indicated charging time is for when the battery has been discharged completely. The charging time may vary depending on how the battery has been used. The charging time for the battery in hot/cold environments or a battery that has not been used for a long time may be longer than normal.

- Use the products supplied with the camera for charging.
- Use the charger indoors.

1 Connect the charger (supplied) and the AC adaptor (supplied) with the USB connection cable (supplied).

- Check the direction of the terminals and plug in/out straight holding onto the plug. (It may result in malfunction by the deforming of the terminal if it is plugged in obliquely or in wrong direction.)

2 Insert the AC adaptor (supplied) into the power outlet.

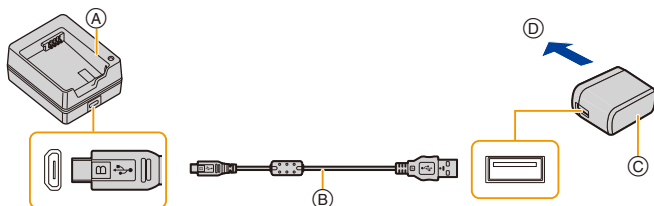

(A) Charger (supplied)

(B) USB connection cable (supplied)

(C) AC adaptor (supplied)

(D) To power outlet

3 Insert the battery (E) in the correct direction.

- The [CHARGE] indicator (F) lights up and charging begins.

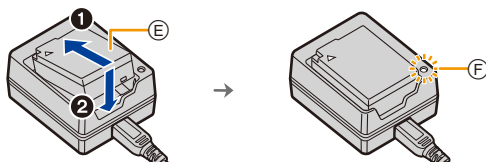

- Do not use any other USB connection cables except the supplied one.
- Do not use any other AC adaptors except the supplied one.
- The AC adaptor (supplied) and USB connection cable (supplied) are for this camera only. Do not use them with other devices.

■ [CHARGE] indicator

On: Charging.

Off: Charging has completed.

(After charging is complete, disconnect the AC adaptor (supplied) from the power outlet and remove the battery.)

• When the [CHARGE] indicator flashes

- The battery temperature is too high or too low. It is recommended to charge the battery again in an ambient temperature of between 10 °C and 30 °C (50 °F and 86 °F).
- The terminals of the charger or the battery are dirty. In this case, wipe them with a dry cloth.

Battery Insertion

- Check that this unit is turned off.

1 Open the battery door.

- Slide the release lever in the direction of the arrow (to the OPEN side).
- **Always use genuine Panasonic batteries.**
- **If you use other batteries, we cannot guarantee the quality of this product.**

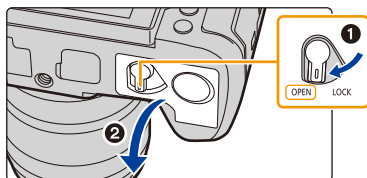

2 Insert the battery.

- Insert the terminal end of the battery and push until a locking sound is heard.
- Check that the lever **A** is holding the battery in place.

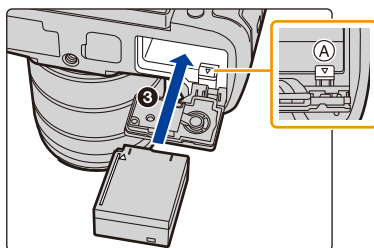

3 Close the battery door.

- Close the battery door, and slide the battery door release lever to the [LOCK] position.

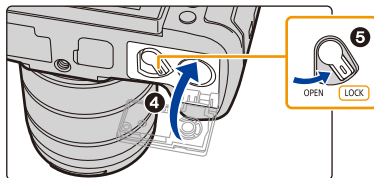

■ Removing the Battery

Push the lever (A) in the direction of the arrow to remove.

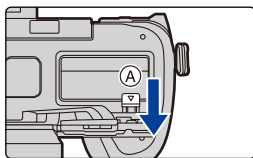

- Confirm that there is no foreign matter adhered on the inner side (rubber seal) of the battery door.
- Remove the battery after use.
(The battery will be exhausted if left for a long period of time after being charged.)
- **The battery becomes warm after using it and during and after charging. The camera also becomes warm during use. This is not a malfunction.**
- Turn the camera off and wait for the "LUMIX" display on the monitor to clear before removing the battery.
(Otherwise, this unit may no longer operate normally and the card itself may be damaged or the recorded pictures may be lost.)
- Be careful when removing the battery as the battery will jump out.

Charge the battery using the camera

Charging time
Approx. 180 min

- Using the camera body and the supplied AC adaptor. The camera is turned off.
- The indicated charging time is for when the battery has been discharged completely. The charging time may vary depending on how the battery has been used. The charging time for the battery in hot/cold environments or a battery that has not been used for a long time may be longer than normal.
- **Use the products supplied with the camera for charging.**
- The battery inserted in the Battery Grip (optional) cannot be charged.

- 1 Turn off the camera.**
- 2 Insert the battery into the camera.**
- 3 Connect the camera [USB/CHARGE] socket and the AC adaptor (supplied) with the USB connection cable (supplied).**

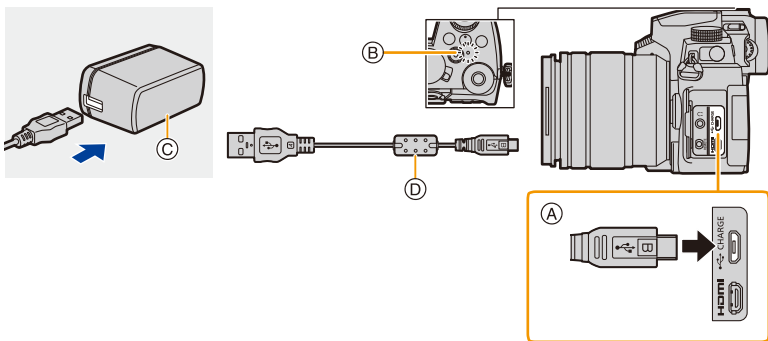

- A Connect the USB connection cable (supplied) to the [USB/CHARGE] socket.**
 - Place the camera in an upright position, and find the terminal at the top.
 - Check the direction of the terminals and plug in/out straight holding onto the plug. (It may result in malfunction by the deforming of the terminal if it is plugged in obliquely or in wrong direction.)
 - Do not connect devices to incorrect terminals. Doing so may cause malfunction.
- B Charging lamp**
- C AC adaptor (supplied)**
- D USB connection cable (supplied)**

- 4 Insert the AC adaptor (supplied) into the power outlet.**

- The camera consumes a small amount of power even after it is turned off by setting the camera on/off switch to [OFF]. When leaving the product unused for a long time, disconnect the AC adaptor (supplied) from the power outlet for power saving.
- You can also charge the battery by connecting a USB device (PC, etc.) and the camera with the USB connection cable (supplied). In that case, charging may take a while.
- Do not use any other USB connection cables except the supplied one.
- Do not use any other AC adaptors except the supplied one.
- The AC adaptor (supplied) and USB connection cable (supplied) are for this camera only. Do not use them with other devices.

■ About the charging lamp

Lit red: Charging.

Off: Charging has completed.
(When charging is complete, disconnect the camera from the power outlet or computer.)

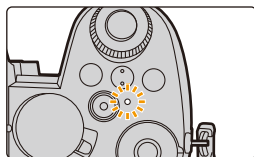



• When the charging lamp flashes

- Reconnect the USB connection cable (supplied) in a location where the ambient temperature (and the temperature of battery) is in a 10 °C to 30 °C (50 °F to 86 °F) range, and try charging again.
- If the USB device (PC etc.) is not capable of supplying sufficient power, charging is not possible.

About the power supply

If you connect the camera to a power outlet (AC adaptor (supplied)) or the USB device (PC etc.) while the camera is turned on, power can be supplied via the USB connection cable (supplied).

- Insert the battery into this unit.
- [] is displayed on the recording screen while power is being supplied.
- **In certain situations where the camera is used, such as during recording, the battery may drain. The camera will turn off when the battery power runs out.**
- Before connecting or disconnecting the AC adaptor (supplied), turn the camera off.
- Power may not be supplied depending on the power supply capacity of the USB device (PC etc.).
- If the ambient temperature is high or power is supplied continuously, after [] is displayed, the supply of power may stop. Wait until the camera cools down.

Notifications regarding charging/power supply

Battery level indication

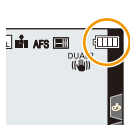

	75% or higher
	50% to 74%
	25% to 49%
	24% or below
 Blinking red	Low battery • Recharge the battery or replace it with a fully charged battery.

- The battery level indicated on the screen is approximate. The exact level varies depending on the environment and the operating conditions.

• It has been found that counterfeit battery packs which look very similar to the genuine product are made available for purchase in some markets. Some of these battery packs are not adequately protected with internal protection to meet the requirements of appropriate safety standards. There is a possibility that these battery packs may lead to fire or explosion. Please be advised that we are not liable for any accident or failure occurring as a result of use of a counterfeit battery pack. To ensure that safe products are used, we recommend that a genuine Panasonic battery pack is used.

- Do not leave any metal items (such as clips) near the contact areas of the power plug. Otherwise, a fire and/or electric shocks may be caused by short-circuiting or the resulting heat generated.
- Do not use a USB extension cable.
- Do not use the AC adaptor (supplied) and the USB connection cable (supplied) for other devices. Doing so may cause malfunction.
- The AC adaptor is in the standby condition when the mains plug is connected. The primary circuit is always "live" as long as the mains plug is connected to an electrical outlet.
- The battery can be recharged even when it still has some charge left, but it is not recommended that the battery charge be frequently topped up while the battery is fully charged. (Since characteristic swelling may occur.)
- If there is a power outage or other problem with the electrical outlet, then charging may not complete successfully.
Reconnect the power plug.
- Do not connect to keyboards or printer USB ports, or to USB hubs.
- If the connected PC enters sleep status, then charging/power supply may stop.

Number of pictures and recordable time

Listed below are the numbers of pictures that can be taken and the time lengths available for recording when the supplied battery is being used.

- The numbers of recordable pictures listed here are based on the CIPA (Camera & Imaging Products Association) standard.
- When a Panasonic SDHC memory card is used.
- The values listed are approximate.

■ Recording still pictures (when using the Monitor)

When the interchangeable lens (H-FS12060) is used	
Number of recordable pictures	Approx. 290 pictures
When the interchangeable lens (H-FSA14140) is used	
Number of recordable pictures	Approx. 290 pictures
When the interchangeable lens (H-FS1442A) is used	
Number of recordable pictures	Approx. 290 pictures

■ Recording still pictures (when using the Viewfinder)

The numbers in parentheses indicate the values that result when [Time] in [Power Save LVF Shooting] is set to [1SEC] and the [Power Save LVF Shooting] function works as intended.

When the interchangeable lens (H-FS12060) is used	
Number of recordable pictures	Approx. 290 pictures (Approx. 1000 pictures)
When the interchangeable lens (H-FSA14140) is used	
Number of recordable pictures	Approx. 290 pictures (Approx. 1000 pictures)
When the interchangeable lens (H-FS1442A) is used	
Number of recordable pictures	Approx. 290 pictures (Approx. 1000 pictures)

■ Recording motion pictures (when using the monitor)

[AVCHD] (Recording with picture quality set to [FHD/17M/50i])

When the interchangeable lens (H-FS12060) is used	
Recordable time	Approx. 110 min
Actual recordable time	Approx. 55 min
When the interchangeable lens (H-FSA14140) is used	
Recordable time	Approx. 100 min
Actual recordable time	Approx. 50 min
When the interchangeable lens (H-FS1442A) is used	
Recordable time	Approx. 100 min
Actual recordable time	Approx. 50 min

[MP4] (Recording with picture quality set to [FHD/28M/50p])

When the interchangeable lens (H-FS12060) is used	
Recordable time	Approx. 100 min
Actual recordable time	Approx. 50 min
When the interchangeable lens (H-FSA14140) is used	
Recordable time	Approx. 100 min
Actual recordable time	Approx. 50 min
When the interchangeable lens (H-FS1442A) is used	
Recordable time	Approx. 100 min
Actual recordable time	Approx. 50 min

[MP4] (Recording with picture quality set to [4K/100M/25p])

When the interchangeable lens (H-FS12060) is used	
Recordable time	Approx. 90 min
Actual recordable time	Approx. 45 min
When the interchangeable lens (H-FSA14140) is used	
Recordable time	Approx. 90 min
Actual recordable time	Approx. 45 min
When the interchangeable lens (H-FS1442A) is used	
Recordable time	Approx. 90 min
Actual recordable time	Approx. 45 min

• Actual recordable time is the time available for recording when repeating actions such as turning this unit on and off, starting/stopping recording, etc.

■ Playback (when using the monitor)

When the interchangeable lens (H-FS12060) is used	
Playback time	Approx. 230 min
When the interchangeable lens (H-FSA14140) is used	
Playback time	Approx. 230 min
When the interchangeable lens (H-FS1442A) is used	
Playback time	Approx. 230 min

- **The operating times and number of recordable pictures will differ according to the environment and the operating conditions.**

For example, in the following cases, the operating times shorten and the number of recordable pictures is reduced.

- In low-temperature environments, such as on ski slopes.
- When flash is used repeatedly.
- When the operating time of the camera becomes extremely short even immediately after charging, the life of the battery has expired. Buy a new battery.

Inserting the Card (Optional)

- Check that this unit is turned off.

1 Slide the card door to open it.

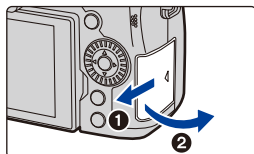

2 Insert the card firmly all the way in until a clicking sound is heard.

- Check the orientation of the card.

(A): Do not touch the connection terminals of the card.

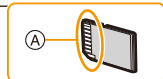
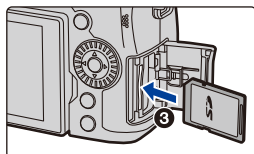

3 Close the card door and slide it firmly in the direction of the arrow until a clicking sound is heard.

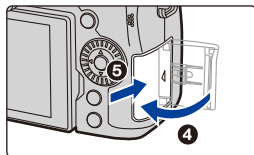

■ To remove
Insert until a clicking sound is heard and then pull it straight out.

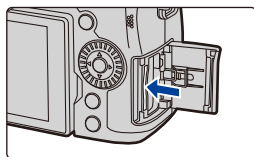

- Turn the camera off and wait for the "LUMIX" display on the monitor to clear before removing the card. (Otherwise, this unit may no longer operate normally and the card itself may be damaged or the recorded pictures may be lost.)

■ Card access indicators

Access indication

The access indication displays red when pictures are being recorded on the card.



- **Do not perform the operations below while the card is being accessed (while image data is being written or read or deletion or formatting is in progress, for example).**

These operations may damage the card or recorded data or cause the camera to stop functioning correctly.

- Turning off the camera
- Removing the battery or card, or disconnect the AC adaptor (optional) and DC coupler (optional)
- Exposing the camera to vibration, impact or static electricity

- **If operation fails due to vibration, impact or static electricity, perform the operation again.**



MENU



Card Information





The following cards which conform to the SD standard can be used with this unit.
(These cards are indicated as **card** in the text.)

SD Memory Card (512 MB to 2 GB)	<ul style="list-style-type: none"> This unit is compatible with UHS-I/UHS-II UHS Speed Class 3 standard SDHC/SDXC memory cards. Operation of the cards on the left has been confirmed with Panasonic's cards.
SDHC Memory Card (4 GB to 32 GB)	
SDXC Memory Card (48 GB to 128 GB)	

■ Recording of motion pictures/4K photos and speed class ratings

Use a card that meets the following ratings of the SD Speed Class or UHS Speed Class.

- SD Speed Class and UHS Speed Class are the speed standards regarding continuous writing. To check the class, see the labelled side, etc. of the card.

[Rec Format]	[Rec Quality]	Speed class	Label example
[AVCHD]	All	Class 4 or higher	CLASS  
	FHD/HD		
[MP4]	4K	UHS Speed Class 3	
High Speed Video/4K Photo/ Post Focus function		UHS Speed Class 3	

• Please confirm the latest information on the following website.

<https://panasonic.jp/support/global/cs/dsc/>

(This Site is English only.)

- If you set the Write-Protect switch (A) to "LOCK", you may not be able to write, delete or format the data or display it by recording date.
- The data on the card may be damaged or lost due to electromagnetic waves, static electricity or breakdown of the camera or the card. We recommend storing important data on a PC etc.
- Keep the memory card out of reach of children to prevent swallowing.

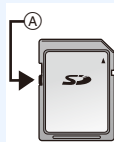

Formatting the card (initialisation)

Format the card before recording a picture with this unit.

Since data cannot be recovered after formatting, make sure to back up necessary data in advance.

MENU →  **[Setup]** → **[Format]**

- Use a battery with sufficient battery power or the AC adaptor (optional) and DC coupler (optional) when formatting.
- Do not turn off the camera or perform other operations during formatting.
- If the card has been formatted on a PC or other equipment, format it on the camera again.

Number of Recordable Pictures, Recordable Time

- The values listed are approximate.

■ Number of recordable pictures

- Aspect ratio [4:3], Quality [■]

[Picture Size]	Card capacity			
	16 GB	32 GB	64 GB	128 GB
L (20M)	1450	2910	5810	11510
M (10M)	2630	5280	10510	20810
S (5M)	4600	9220	17640	34940

- Aspect ratio [4:3], Quality [RAW■]

[Picture Size]	Card capacity			
	16 GB	32 GB	64 GB	128 GB
L (20M)	450	900	1810	3590
M (10M)	520	1050	2110	4180
S (5M)	570	1150	2290	4550

■ Available recording time (when recording motion pictures)

- “h” is an abbreviation for hour, “m” for minute and “s” for second.
- The recordable time is the total time of all the motion pictures which have been recorded.

- [AVCHD]

[Rec Quality]	Card capacity			
	16 GB	32 GB	64 GB	128 GB
[FHD/28M/50p]	1h10m	2h30m	5h00m	9h55m
[FHD/17M/50i]	2h00m	4h05m	8h15m	16h25m
[FHD/24M/25p] [FHD/24M/24p]	1h25m	2h55m	5h50m	11h35m

• [MP4]

[Rec Quality]	Card capacity			
	16 GB	32 GB	64 GB	128 GB
[4K/100M/30p] [4K/100M/25p] [4K/100M/24p]	20m00s	41m00s	1h25m	2h45m
[FHD/28M/60p] [FHD/28M/50p]	1h10m	2h25m	5h00m	9h55m
[FHD/20M/30p] [FHD/20M/25p]	1h35m	3h15m	6h40m	13h15m
[HD/10M/30p] [HD/10M/25p]	3h05m	6h20m	12h45m	25h20m

- Depending on the recording conditions and the type of card, the number of recordable pictures and available recording time vary.
- [9999+] is displayed on the recording screen if there are 10000 or more recordable pictures remaining.
- When the recording format is [AVCHD]:
Files exceeding 4 GB in size will be split up and saved as smaller files. (You can continue recording without interruption.)
- When the recording format is [MP4] (with the size for [Rec Quality] set to [FHD]/[HD]):
Files will be split up and saved and played back as smaller files if the continuous recording time exceeds 30 minutes or the file size exceeds 4 GB. (You can continue recording without interruption.)
- When the recording format is [MP4] (with the size for [Rec Quality] set to [4K]):
Files will be split up and saved and played back as smaller files in the following cases. (You can continue recording without interruption.)

When using an SDHC memory card:

If the file size exceeds 4 GB

When using an SDXC memory card:

If the continuous recording time exceeds 3 hours and 4 minutes or the file size exceeds 96 GB

- **The maximum available continuous recording time is displayed on the screen.**

■ Removing a Lens

- Attach the lens cap.

While pressing on the lens release button **(A)**, rotate the lens toward the arrow until it stops and then remove.

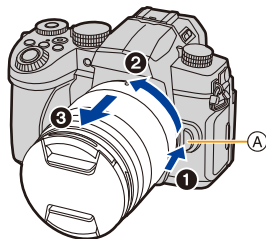

- When the lens is removed from the camera, dust and other particles may accumulate on or enter the camera or lens.
Be sure to attach the body cap and the lens rear cap.

■ Attaching a Lens Hood

When recording into strong backlight, irregular reflection may occur within the lens. The lens hood reduces the inclusion of unwanted light in the recorded images and lowers the drop in contrast. The lens hood cuts off excess lighting and improves the picture quality.

To attach the lens hood (flower shape) that came with the interchangeable lenses (H-FS12060/H-FSA14140/H-FS1442A)

Hold the lens hood by placing your fingers as shown in the figure.

- Do not hold the lens hood in such a way that it will be bent.



- 1** Align the mark **(A)** (●) on the lens hood with the mark on the tip of the lens.

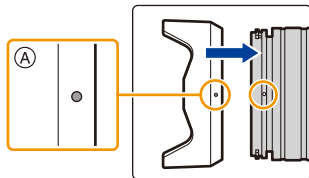

- 2** Rotate the lens hood in the direction of the arrow until it clicks and then align the mark **(B)** (◻) on the lens hood with the mark on the tip of the lens.

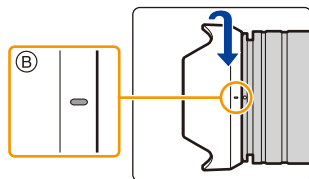

■ **Removing the lens hood (H-FS12060)**

Turn the lens hood in the direction of the arrow to detach it.

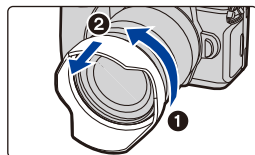

 **Temporarily Storing the Lens Hood**

Example: H-FS12060

- 1 Remove the lens hood.
- 2 Align the mark © () on the lens hood with the mark on the tip of the lens.
- 3 Turn the lens hood in the direction of the arrow until it clicks into place.

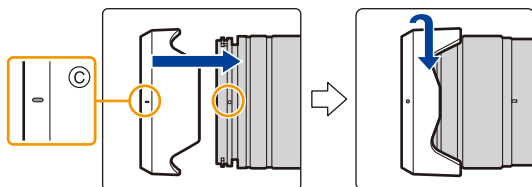

Changing the Monitor Position

At the time when this camera is purchased, the monitor is stowed in the camera body. Bring out the monitor as shown below.

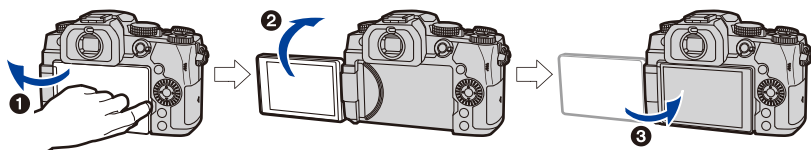

- ❶ Open the monitor. (It opens up to 180°.)
- ❷ It can be rotated 180° forward.
- ❸ Return the monitor to its original position.

• When rotating the monitor, be careful not to apply too much force. Doing so may cause damage.

■ Free angle shooting

The monitor can be rotated to suit your needs. This is convenient as it allows you to take pictures from various angles by adjusting the monitor.

Taking pictures at a high angle

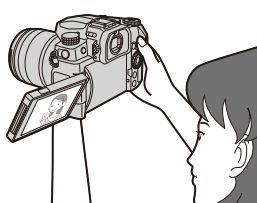

Taking pictures at a low angle

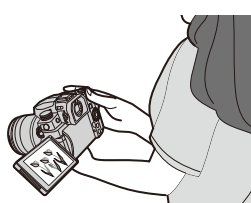
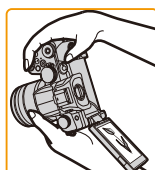

• When not using the monitor it is recommended that you close it with the screen facing inward to prevent dirt and scratches.

Setting the Clock (When Turning On for the First Time)

- The clock is not set when the camera is shipped.

1 Turn the camera on.

- If the language select screen is not displayed, proceed to step 4.

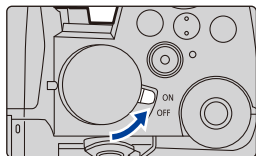

2 Press [MENU/SET].

3 Press ▲/▼ to select the language, and press [MENU/SET].

4 Press [MENU/SET].

5 Press ◀/▶ to select the items (year, month, day, hour, minute), and press ▲/▼ to set.

- Ⓐ: Time at the home area
- Ⓑ: Time at the travel destination

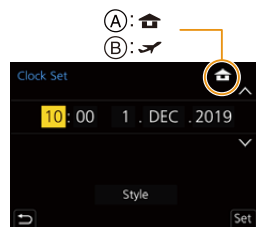

To set the display order and the time display format.

- To display the setting screen of the order/time, select [Style] and then press [MENU/SET].

6 Press [MENU/SET] to set.

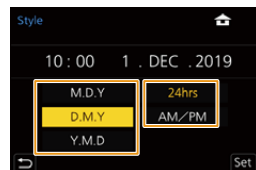

- 7 When [The clock setting has been completed.] is displayed, press [MENU/SET].
- 8 When [Please set the home area] is displayed, press [MENU/SET].
- 9 Press ◀/▶ to select the home area, and then press [MENU/SET].



■ Re-adjusting the clock

MENU → ⚙ [Setup] → [Clock Set]

- The clock can be reset as shown in steps 5 and 6 on P39.
- The clock setting is maintained for 3 months using the built-in clock battery even without the battery.
(Leave the charged battery in the unit for 24 hours to charge the built-in battery.)
- To place the correct date on pictures, set the clock before recording.

Basic Operations

How to Hold the Camera

Hold the camera gently with both hands, keep your arms still at your side and stand with your feet slightly apart.

- Do not cover the flash (A), AF Assist lamp (B), microphone (C), or speaker (D) with your fingers or other objects.
- Make sure your footing is stable and there is no danger of colliding with another person or object in the vicinity while taking pictures.

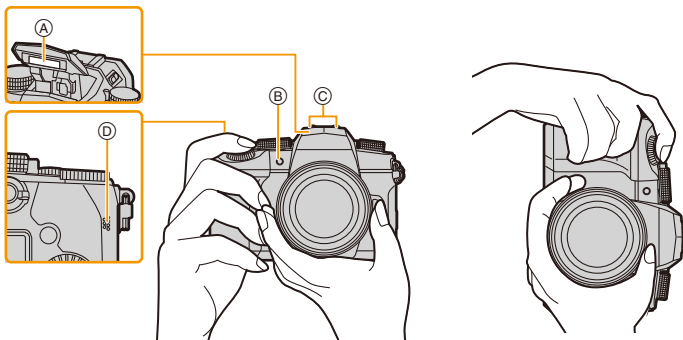

■ Detects orientation of camera (Direction Detection Function)

This function detects the vertical orientation when you record with the camera vertically orientated.

When you play back the recording, the recording is automatically displayed in vertical orientation.

(Only available when [Rotate Disp.] is set to [ON].)

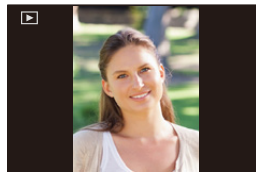

- When the camera is held vertically and tilted significantly up or down to record, the Direction Detection Function may not work correctly.
- Motion pictures, 4K burst files, and images recorded with the Post Focus function cannot be displayed vertically.

Using the Viewfinder

Adjusting the Viewfinder Dioptre

Rotate the dioptre adjustment dial until you can see the characters displayed in the viewfinder clearly.

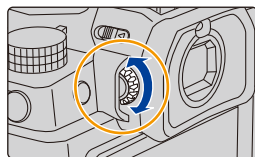

Switching the Monitor/Viewfinder

Press [LVF].

- (A) [LVF] button
- (B) Eye sensor

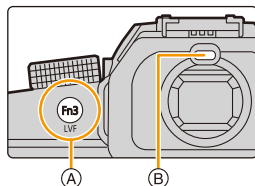

Automatic viewfinder/
monitor switching

Viewfinder display

Monitor display

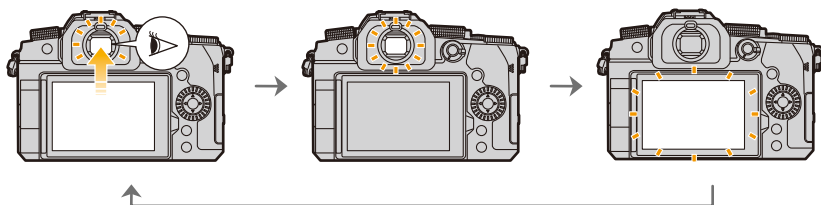

■ Notes on automatic viewfinder/monitor switching

Bring your eye or an object near the viewfinder to automatically switch to the viewfinder display using the eye sensor.

- To reduce the battery consumption, set [Power Save LVF Shooting] in [Economy] (P231).
- Eye sensor might not work properly depending on the shape of your eyeglasses, the way you hold the camera, or bright light shining around the eyepiece.
- Automatic viewfinder/monitor switching does not work during motion picture playback and slide shows.
- The eye sensor does not work depending on the angle of the monitor.
- If [Eye Sensor AF] in the [Custom] ([Focus / Release Shutter]) menu is set to [ON], the camera automatically adjusts the focus as the eye sensor is activated. The camera does not beep when focus is achieved with [Eye Sensor AF].

Shutter button (Taking pictures)

The shutter button works in two steps.

Press the shutter button halfway to focus.

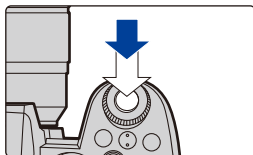

- Aperture value and shutter speed are displayed. (It will flash in red if the correct exposure is not achieved, except when set to flash.)
- Once the subject is in focus, the focus indication is displayed. (When the subject is not in focus, the indication flashes.)

- (A) Shutter speed
- (B) Aperture value
- (C) Focus indication



Press the shutter button fully (push it in further), and take the picture.

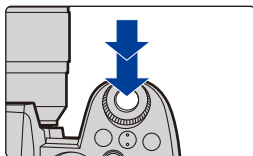

- **Make sure that the camera does not move at the moment the shutter button is pressed.**
- **Pictures cannot be taken until focus is achieved when [Focus/Release Priority] is set to [FOCUS].**
- Even during menu operation or image playback, if you press the shutter button halfway, you can instantly set the camera ready for recording.

Motion picture button (Recording motion pictures)

Start recording by pressing the motion picture button.

- Release the motion picture button right after you press it.

Stop the recording by pressing the motion picture button again.

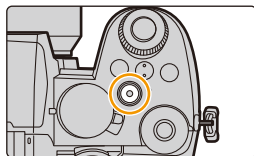



Mode dial (Selecting a Recording Mode)

Rotate the mode dial and select the recording mode.

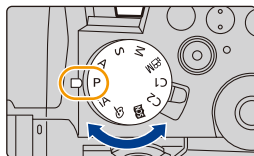
- Be sure to align the mode dial with the desired mode by rotating it slowly.



iA	Intelligent Auto Mode (P65)
	Intelligent Auto Plus Mode (P66)
P	Program AE Mode (P71)
A	Aperture-Priority AE Mode (P73)
S	Shutter-Priority AE Mode (P73)
M	Manual Exposure Mode (P74)
 M	Creative Video Mode (P180)
C1C2	Custom Mode (P80)
 SCN	Scene Guide Mode (P82)
	Creative Control Mode (P87)



Front Dial/Rear Dial

Rotating: Selects an item or numeric value.

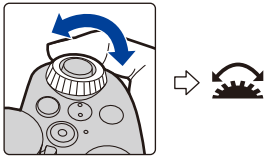
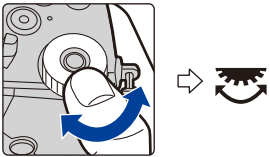
- These operating instructions describe operations of the front dial/rear dial as follows:

	
e.g.: When rotating the front dial to the left or right	e.g.: When rotating the rear dial to the left or right

Allows you to set the aperture, shutter speed, and other settings when in P/A/S/M modes.

Mode dial	 Front dial	 Rear Dial
P	Programme Shift	Programme Shift
A	Aperture value	Aperture value
S	Shutter speed	Shutter speed
M	Aperture value	Shutter speed

■ Setting the functions to be assigned to the dials in the ISO sensitivity settings screen

MENU →  [Custom] →  [Operation] → [ISO Displayed Setting] → [Front/Rear Dials]

[ISO/ISO]	[Sensitivity]/[Sensitivity]
[ISO LIMIT/ISO]	[ISO Auto Upper Limit Setting]/[Sensitivity]
[OFF/ISO]	[OFF]/[Sensitivity]
[ISO/ISO LIMIT]	[Sensitivity]/[ISO Auto Upper Limit Setting]
[ISO/OFF]	[Sensitivity]/[OFF]

■ Setting the functions to be assigned to ▲/▼ and dials in the exposure compensation screen

MENU → [Custom] → [Operation] → [Exposure Comp. Disp. Setting]

[Cursor Buttons (Up/Down)]		[Exposure Bracket]
	[OFF]	[OFF]
[Front/Rear Dials]		[Exposure Comp.]/[Exposure Comp.]
		[Flash Adjust.]/[Exposure Comp.]
	[OFF]/	[OFF]/[Exposure Comp.]
	/	[Exposure Comp.]/[Flash Adjust.]
	/[OFF]	[Exposure Comp.]/[OFF]

Temporarily changing the items assigned to the front/rear dials ([Dial Operation Switch])

1 Set a Fn button to [Dial Operation Switch]. (P60)

- This function is set in the Fn button (Fn1) at the time of purchase.

2 Press the Fn button.

- A guide will be displayed showing the items temporarily assigned to the front/rear dials.
- If no operations are performed, the guide will disappear in a few seconds.



3 Rotate the front/rear dials while the guide is displayed.

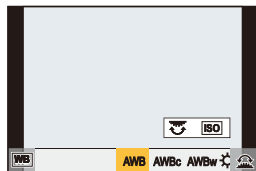

4 Press [MENU/SET] and set.

- You can also complete this step by performing either of the operations below:
 - Press the shutter button halfway
 - Press the Fn button

- You can set the following settings in [Dial Set.] of the [Custom] ([Operation]) menu. (P48)
 - Operation methods of the front/rear dials
 - Operation method of the control dial
 - Items to be assigned temporarily to the front/rear dials in [Dial Operation Switch]

Control Dial





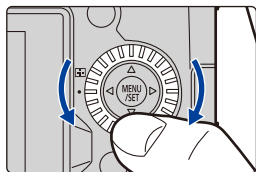













Rotating: Selects an item or numeric value.





- This is expressed as follows in this document:
 - When rotating the control dial to the left or right: 



■ Setting the operation methods of the dial

MENU →  [Custom] →  [Operation] → [Dial Set.]

<p>[Assign Dial (F/SS)]</p>	<p>Sets the operations to be assigned to the dials in Manual Exposure Mode.</p> <p>[ F  SS]: Assigns the aperture value to the front dial, and the shutter speed to the rear dial.</p> <p>[ SS  F]: Assigns the shutter speed to the front dial, and the aperture value to the rear dial.</p>
<p>[Rotation (F/SS)]</p>	<p>Changes the rotation direction of the dials for adjusting the aperture value and shutter speed.</p> <p>[ ]/[ ]</p>
<p>[Control Dial Assignment]</p>	<p>Sets the function to be assigned to the control dial in the recording screen.</p> <p>[] ([Headphone Volume])/</p> <p>[ / ] ([Exposure / Aperture])*¹/</p> <p>[] ([Exposure Comp.])/[[ISO]] ([Sensitivity])/</p> <p>[] ([Focus Frame Size])*²</p> <p>*1 This assigns exposure compensation operation. It adjusts the aperture value in Manual Exposure Mode.</p> <p>*2 This assigns the following operations:</p> <ul style="list-style-type: none"> When the AF Mode is [], [], [] or []: Changing the AF area size When the AF Mode is [] or the Focus Mode is MF: Changing the assist screen magnification

[Exposure Comp.]	Assigns exposure compensation operation to the front/rear dial. (Except in Manual Exposure Mode) [] (Front Dial)/ [] (Rear Dial)/ [OFF]												
[Dial Operation Switch Setup]	Sets the items to be assigned temporarily to the front/rear dials when you press the Fn button to which [Dial Operation Switch] is assigned. [] ([Front Dial Operation])/ [] ([Rear Dial Operation]) • Items that can be set are as follows. <table border="0" data-bbox="424 320 901 487"> <tr> <td>– [Photo Style]</td> <td>– [i.Resolution]</td> </tr> <tr> <td>– [Filter Effect]</td> <td>– [Flash Mode]</td> </tr> <tr> <td>– [Aspect Ratio]</td> <td>– [Flash Adjust.]</td> </tr> <tr> <td>– [4K PHOTO]</td> <td>– [Sensitivity]</td> </tr> <tr> <td>– [Highlight Shadow]</td> <td>– [White Balance]</td> </tr> <tr> <td>– [i.Dynamic]</td> <td>– [AF Mode]</td> </tr> </table> • [Highlight Shadow] uses the two dials.	– [Photo Style]	– [i.Resolution]	– [Filter Effect]	– [Flash Mode]	– [Aspect Ratio]	– [Flash Adjust.]	– [4K PHOTO]	– [Sensitivity]	– [Highlight Shadow]	– [White Balance]	– [i.Dynamic]	– [AF Mode]
– [Photo Style]	– [i.Resolution]												
– [Filter Effect]	– [Flash Mode]												
– [Aspect Ratio]	– [Flash Adjust.]												
– [4K PHOTO]	– [Sensitivity]												
– [Highlight Shadow]	– [White Balance]												
– [i.Dynamic]	– [AF Mode]												

Cursor buttons/[MENU/SET] button

Pressing the cursor button:

Selection of items or setting of values etc., is performed.

- These operating instructions expresses the up, down, left, and right of the cursor button as **▲/▼/◀/▶**.

Pressing [MENU/SET]:

Confirmation of setting contents, etc., is performed.

- Displays the menu during recording and playback.

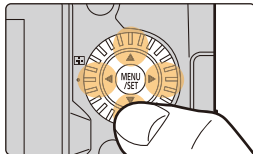

[DISP.] button (switching the information display)

Press [DISP.].

- The display information is switched.

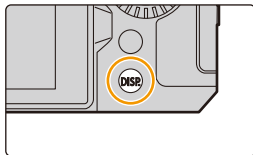

In Recording Mode

You can switch the viewfinder/monitor display method.

MENU → [Custom] → [Monitor / Display] → [LVF/Monitor Disp. Set] → [LVF Disp. Set]/[Monitor Disp. Set]

(viewfinder style)	Scales down images slightly so that you can better review the composition of the images.
(monitor style)	Scales images to fill the entire screen so that you can see their details.

• Viewfinder style (viewfinder display shown as example)

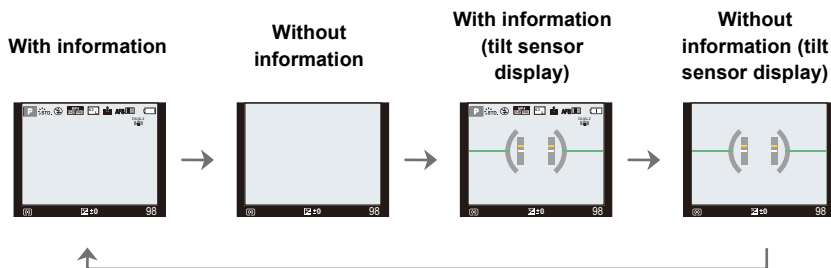

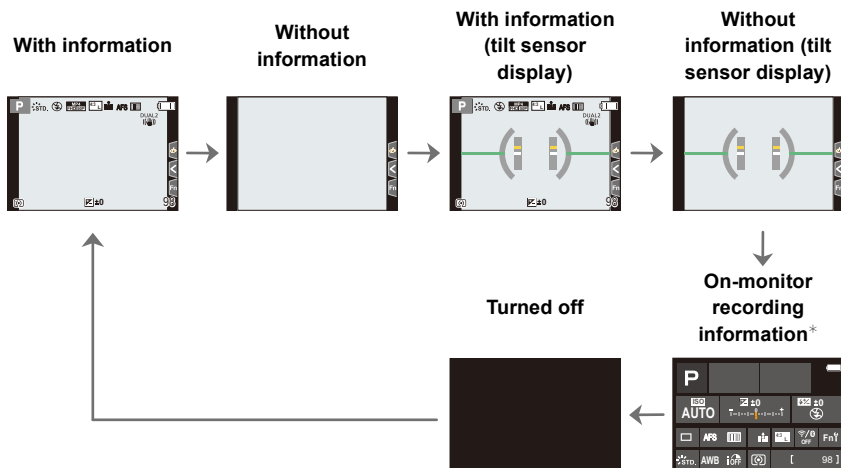

• Monitor style (monitor display shown as example)



* It is displayed when [Monitor Info. Disp.] in the [Custom] ([Monitor / Display]) is set to [ON]. You can touch the desired item and change its setting directly.

- With [Fn Button Set] in the [Custom] ([Operation]) menu, you can assign [LVF/Monitor Disp. Style] to a Fn button.

Each time you press the assigned Fn button, the display style of the monitor or viewfinder ([]/[]), whichever is currently in use, will change.

- If no operation is performed, the information on the screen will gradually become darker after approximately 10 seconds has passed, and will no longer be displayed after approximately 1 minute has passed.

Pressing the [DISP.] button or touching the monitor will make the display reappear.

This operation is to prevent screen burn-in and is not a malfunction.

■ About the tilt sensor display

With the tilt sensor displayed, it is easy to correct the tilt of the camera etc.

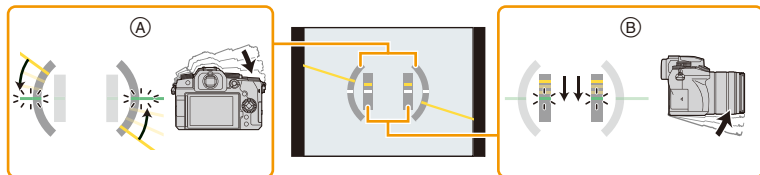

- (A) **Horizontal direction:** Correcting tilt to the left
- (B) **Vertical direction:** Correcting downward tilt

- When the camera is tilted very little or not at all, the level gauge will turn green.
- Even after correcting the tilt, there may still be an error of approximately $\pm 1^\circ$.
- When tilted significantly upwards or downwards to record, the tilt sensor display may not be displayed correctly, and the Direction Detection Function may not work correctly.

In Playback Mode

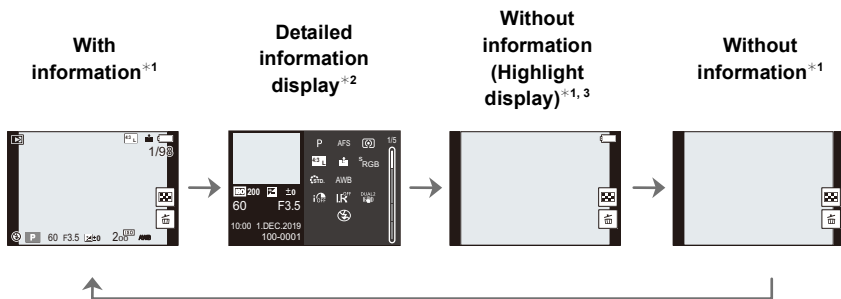

*1 If approximately 10 seconds elapses without an operation being performed, the display will disappear.

Press [DISP.] or touch the monitor to make the display reappear.

This operation is to prevent screen burn-in and is not a malfunction.

*2 Press ▲/▼ to switch between the following display modes:

- Detailed information display
- Histogram display
- Photo style, Highlight shadow display
- White balance display
- Lens information display

*3 This is displayed if [Highlight] in the [Custom] ([Monitor / Display]) menu is set to [ON].

Touch screen (Touch operations)

■ Touch

To touch and release the touch screen.



■ Drag

A movement without releasing the touch screen.

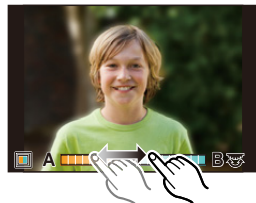

■ Pinch (enlarge/reduce)

On the touch screen, spread (pinch out) two fingers to zoom in and narrow (pinch in) them to zoom out.



- Touch the screen with the clean and dry finger.
- If you use a commercially available monitor protection sheet, please follow the instructions that accompany the sheet.
(Some monitor protection sheets may impair visibility or operability.)

Not available in these cases:

- The touch screen may not function normally in the following cases.
 - When touched by a gloved hand
 - When the touch screen is wet

Taking Pictures Using the Touch Function

Touch AF/Touch Shutter

Applicable modes:   P A S M   



1 Touch .



2 Touch an icon.

- The icon switches every time you touch it.



 (Touch AF)	Focuses on the position you touch.*
 (Touch shutter)	Focuses on the touched position before recording takes place.*
 (OFF)	Touch AF and Touch Shutter are disabled.

* When [Touch AF] in [Touch Settings] of the [Custom] ([Operation]) menu is set to [AF+AE], the focus and brightness are optimised for the touched position. (P106)

3 (When settings other than OFF are selected)
Touch the subject.

- When [] (Touch AF) is set, refer to P102 for information about the operation to change the size and position of the AF area.



• If shooting with the touch shutter fails, the AF area turns red and disappears.

Touch AE

Applicable modes:   P A S M   

You can easily optimise the brightness for a touched position. When the face of the subject appears dark, you can brighten the screen according to the brightness of the face.

1 Touch [].



2 Touch [].

- The setting screen for the brightness optimisation position is displayed.
- [Metering Mode] is set to [, which is used exclusively for the Touch AE.

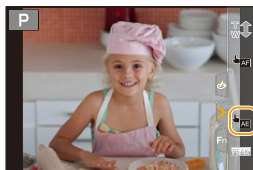

3 Touch the subject you want to optimise the brightness for.

- Touch [Reset] to bring the brightness optimisation position back to the centre.



4 Touch [Set].

■ Cancelling the Touch AE function

Touch [].

Not available in these cases:

- This function is not available in the following cases:
 - When using the Digital Zoom
 - When [4K Live Cropping] is set
 - When [Touch AF] in [Touch Settings] of the [Custom] ([Operation]) menu has been set to [AF+AE]

Setting menu items

You can either operate the buttons or touch the monitor to set menu items.

1 Press [MENU/SET] to display the menu.

2 Press ◀.

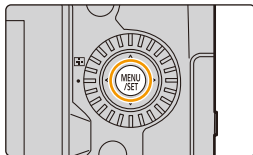

3 Press ▲/▼ to select a menu selector icon, such as [📷].

- You can also select the menu toggle icons by rotating the front dial.

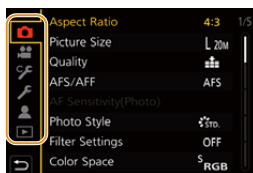

[Intelligent Auto] (P68)	These menus let you set the functions available for their corresponding Recording Modes.
[Creative Video] (P180)	
[Custom Mode] (P81)	
[Scene Guide] (P82)	
[Creative Control] (P88)	
[Rec] (P193)	This menu lets you set picture settings.
[Motion Picture] (P210)	This menu lets you set motion picture settings.
[Custom] (P213)	Operation of the unit, such as displaying of the screen and button operations, can be set up according to your preferences.
[Setup] (P228)	This menu lets you perform the clock settings, select the operating beep tone settings and set other settings which make it easier for you to operate the camera. You can also configure the settings of Wi-Fi/Bluetooth related functions.
[My Menu] (P238)	This menu lets you register frequently-used menus.
[Playback] (P239)	This menu lets you set the playback and editing settings for images.

- The [Setup] menu contains some important settings relating to the camera's clock and power. Check the settings of this menu before proceeding to use the camera.

4 Press [MENU/SET].

Touch operation

Touch a menu selector icon, such as .

5 Press ▲/▼ of the cursor button to select the menu item and press [MENU/SET].

- You can also move to the next screen by rotating the rear dial.

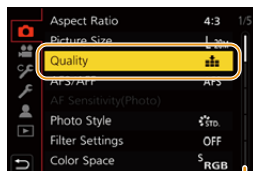

Touch operation

Touch the menu item.

- You can switch the page by touching the bar  on the right side of the screen.

6 Press ▲/▼ of the cursor button to select the setting and press [MENU/SET].

- Depending on the menu item, its setting may not appear or it may be displayed in a different way.

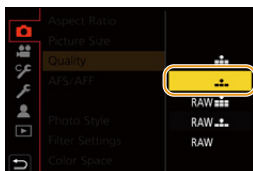

Touch operation

Touch the Setting to set.

- You can also rotate the control dial to select the menu selector icon, menu item, or setting.

■ Close the menu

Press [↵] or press the shutter button halfway.



Touch operation

Touch [↵].



- Press [DISP.] to display the menu description.
- Menu items that are not available are displayed in grey. If you press [MENU/SET] while a grey item is selected, the reason why it cannot be set is displayed in some setting situations.



Quick Menu

This menu enables you to quickly set functions that are frequently used during recording without calling the menu screen.

1 Press [Q.MENU] to display the Quick Menu.

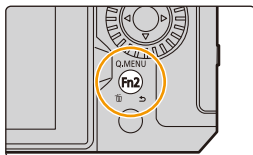

2 Rotate the front dial to select the menu item.

- Setting can also be performed by rotating the control dial.

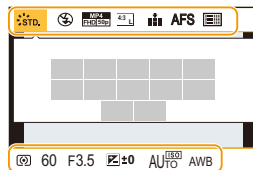

3 Rotate the rear dial to select the setting.

4 Press [Q.MENU] to exit the Quick Menu once the setting is complete.

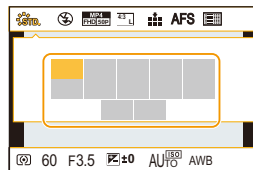

- You can also select menu items and setting items by pressing ▲/▼/◀/▶.
- The features that can be adjusted using Quick Menu are determined by the mode or a display style the camera is in.

When using the on-monitor recording information screen (P49)

Select the item by pressing the [Q.MENU] button and rotating the front dial, and then select the setting by rotating the rear dial.

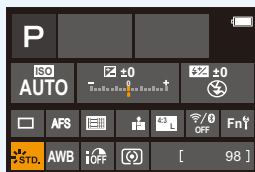

Customising the Quick Menu settings

You can add a maximum of 15 preferred settings to the Quick Menu.

1 Select the menu.

MENU → [Custom] → [Operation] → [Q.MENU] → [CUSTOM]

2 Press the shutter button halfway to close the menu.

3 Press [Q.MENU] to display the Quick Menu.

4 Press ▼ to select [] and then press [MENU/SET].

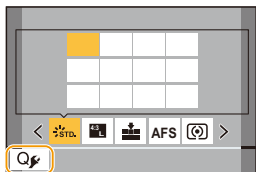

5 Press ▲/▼/◀/▶ to select the menu item in the top row and then press [MENU/SET].

- Items that have already been set in the top row are displayed in light grey.

6 Press ◀/▶ to select the empty space in the bottom row and then press [MENU/SET].

- (A) Items that can be set
- (B) Set items

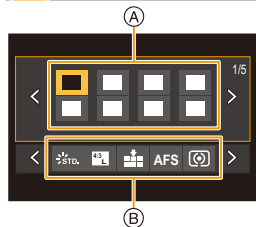

- You can also perform the same operation by dragging the item from the top row to the bottom row.
- If there is no empty space in the bottom row, you can replace an existing item with a new select item by selecting the existing item.
- You can follow the steps below to cancel the setting.
 - ① Press ▼ to move to the bottom row.
 - ② Press ◀/▶ to select the item to be cancelled and then press [MENU/SET].

7 Press [↵].

- It will return to screen of step 4.
Press [MENU/SET] to switch to the recording screen.

Fn Buttons

You can register functions to the Fn (Function) buttons.

Different functions can be set for both during recording and playback.

1 Select the menu.

MENU →  [Custom] →  [Operation] → [Fn Button Set] →
[Setting in REC mode]/[Setting in PLAY mode]

2 Press ▲/▼ to select the Fn button you want to assign a function to and then press [MENU/SET].

3 Press ▲/▼ to select the function you want to assign and then press [MENU/SET].

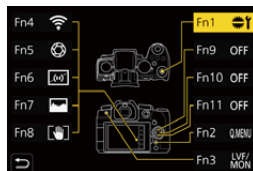

- For details on the functions that can be assigned in [Setting in REC mode], refer to [P61](#).
- For details on the functions that can be assigned in [Setting in PLAY mode], refer to [P63](#).
- To restore the default Fn button settings, select [Restore to Default].
- When not setting a function in the Fn button, select [Off].

■ Setting function buttons from the on-monitor recording information screen

You can also display the screen in step 2 by touching [Fn] on the on-monitor recording information screen ([P49](#)).

■ Assigning functions quickly

You can quickly display the screen in step 3 by pressing and holding an Fn button ([Fn1] to [Fn3], [Fn9] to [Fn11]) for 2 seconds. (This screen, however, may not be displayed depending on conditions such as the function registered or the screen displayed.)

- Some functions may not be available depending on the mode or the displayed screen.
- Some functions cannot be assigned depending on the Fn button.

Using the Fn buttons during recording

You can use assigned functions by pressing the corresponding Fn buttons.

■ Using Fn buttons with touch operations

- 1 Touch [Fn].
- 2 Touch [Fn4], [Fn5], [Fn6], [Fn7] or [Fn8].



■ Functions that can be assigned in [Setting in REC mode]

<ul style="list-style-type: none"> - [Wi-Fi] (P257) - [Q.MENU] (P58) - [Video Record] (P169) - [LVF/Monitor Switch] (P42) - [LVF/Monitor Disp. Style] (P49) - [AF/AE LOCK] (P110) - [AF-ON] (P110) - [Preview] (P78) - [One Push AE] (P79) - [Touch AE] (P54) - [Level Gauge] (P50) - [Focus Area Set] - [Zoom Control] (P155) - [1 Shot "4K PHOTO"] - [Operation Lock] - [Focus Ring Lock] (P218) - [Dial Operation Switch] (P46) - [Photo Style] (P196) - [Filter Effect] (P87) - [Aspect Ratio] (P194) - [Picture Size] (P194) - [Quality] (P195) - [AFS/AFF] (P95) - [Metering Mode] (P201) 	<ul style="list-style-type: none"> - [Burst Rate] (P119) - [4K PHOTO] (P122) - [Self Timer] (P143) - [Bracket] (P144) - [Highlight Shadow] (P201) - [i.Dynamic] (P202) - [i.Resolution] (P203) - [Min. Shtr Speed] (P204) - [HDR] (P208) - [Shutter Type] (P206) - [Flash Mode] (P162) - [Flash Adjust.] (P165) - [Wireless Flash Setup] (P166) - [Ex. Tele Conv.] (P154) - [Digital Zoom] (P156) - [Stabilizer] (P148) - [E-Stabilization (Video)] (P150) - [I.S. Lock (Video)] (P151) - [4K Live Cropping] (P182) - [Snap Movie] (P176) - [Motion Pic. Set] (P171) - [Picture Mode in Rec.] (P175) 	<ul style="list-style-type: none"> - [Sound Rec Level Disp.] (P179) - [Sound Rec Level Adj.] (P179) - [Mic. Directivity Adjust] (P309) - [Silent Mode] (P206) - [Peaking] (P220) - [Histogram] (P221) - [Guide Line] (P221) - [Zebra Pattern] (P222) - [Monochrome Live View] (P219) - [Constant Preview] (P220) - [Live View Boost] (P220) - [Rec Area] (P223) - [Step Zoom] (P157) - [Zoom Speed] (P157) - [Exposure Comp.] (P111) - [Sensitivity] (P113) - [White Balance] (P115) - [AF Mode/MF] (P97) - [Rec / Playback Switch] - [Restore to Default]
---	--	--

- Fn button settings at the time of purchase.

Fn1	[Dial Operation Switch]
Fn2	[Q.MENU]
Fn3	[LVF/Monitor Switch]
Fn4	[Wi-Fi]
Fn5	[Preview]
Fn6	[Level Gauge]

Fn7	[Histogram]
Fn8	[I.S. Lock (Video)]
Fn9	No function is set by default.
Fn10	
Fn11	

- With [Video Record], you can start/stop recording a motion picture in the same way as with the motion picture button.
- When set to [Focus Area Set], it is possible to display the position setting screen of either AF area or MF Assist.
- When [1 Shot "4K PHOTO"] is set, recording is performed in a specified 4K Photo Mode only once. After the recording has finished, the camera returns to normal state.
- When [Operation Lock] is set, a certain type of operation is disabled. Set the type of operation to be disabled in [Operation Lock Setting] in the [Custom] ([Operation]) menu. (P218)
- If you assign [Rec / Playback Switch], you can switch between recording and playback modes.
- If the screen displays **A** or similar, the displayed operation will be performed instead of the function assigned to Fn buttons by [Fn Button Set].

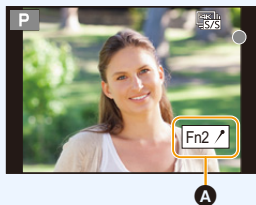

Using the Fn buttons during playback

You can use an assigned function by pressing the appropriate Fn button.

• Depending on the function, you can directly use it for the image being played back.

Example: When [Fn1] is set to [Rating★3]

- 1 Press ◀/▶ to select the image.
- 2 Press the Fn button (Fn1) to set the image as [Rating★3].



■ Functions that can be assigned in [Setting in PLAY mode]

• The following functions can be assigned to the Fn button (Fn1)/[Fn3].

<ul style="list-style-type: none"> – [Wi-Fi] (P257) – [LVF/Monitor Switch] (P42) – [Rec / Playback Switch] – [4K PHOTO Play] – [Delete Single] (P191) – [Protect] (P242) – [Rating★1] (P242) 	<ul style="list-style-type: none"> – [Rating★2] (P242) – [Rating★3] (P242) – [Rating★4] (P242) – [Rating★5] (P242) – [RAW Processing] (P244) – [4K PHOTO Bulk Saving] (P128) – [Restore to Default]
---	--

• Fn button settings at the time of purchase.

Fn1	[Wi-Fi]
Fn3	[LVF/Monitor Switch]

• If you assign [4K PHOTO Play], a screen will be displayed, allowing you to select the pictures to be extracted from a 4K burst file and saved.

Entering Text

Follow the steps below when the text entry screen is displayed.

1 Press ▲/▼/◀/▶ to select text and then press [MENU/SET] to register.

- To repeatedly enter the same character, rotate the front/rear dial or the control dial to the right to move the entry location.
- Operations when the items below are selected

- [A/a]: Switch text between [A] (upper case characters), [a] (lower case characters), [1] (numbers), and [&] (special characters)*
- []: Enter a blank
- [Delete]: Delete a character
- [◀]: Move the entry position cursor to the left
- [▶]: Move the entry position cursor to the right

- * You can also switch between text modes by pressing [DISP].
- A maximum of 30 characters can be entered.
(Maximum of 9 characters when setting names in [Face Recog.]
- A maximum of 15 characters can be entered for [], [Γ], []], [•] and [—].
(Maximum of 6 characters when setting names in [Face Recog.]



2 Press ▲/▼/◀/▶ to move the cursor to [Set] and then press [MENU/SET] to end text input.

3.

Recording Modes

Easy Recording (Intelligent Auto Mode)

Recording Mode:  

The [iA] mode (Intelligent Auto mode) can record images using settings automatically selected by the camera.

In this mode, the camera makes the optimal settings for the subject and scene.

1 Set the mode dial to [iA].

- At the time of purchase, the mode is set to Intelligent Auto Plus Mode.

2 Hold the camera with the lens facing toward the subject.

- When the camera identifies the optimum scene, the icon of the scene concerned will change. (Automatic Scene Detection)

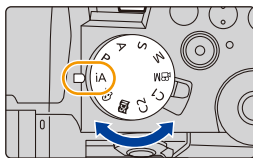

The camera detects scenes automatically (Scene Detection)

(📷: When taking pictures, 📹: When recording motion pictures)

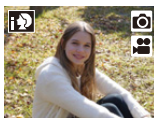

[i-Portrait]



[i-Scenery]

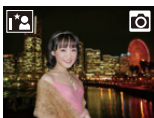

[i-Macro]

[i-Night Portrait]^{*1}

[i-Night Scenery]

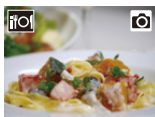
[iHandheld Night Shot]^{*2}

[i-Food]

[i-Baby]^{*3}

[i-Sunset]



[i-Low Light]



iA

*1 Displayed when a flash is used.

*2 Only displayed when [iHandheld Night Shot] is set to [ON].

*3 Displayed when persons under 3 years old registered in the camera with the Face Recognition function are detected.

• [iA] is set if none of the scenes are applicable, and the standard settings are set.

• When recording is performed with the 4K Photo or Post Focus function, Scene Detection works in the same way as when motion picture is recorded.

■ Switching between Intelligent Auto Plus Mode and Intelligent Auto Mode

1 Select the menu.

MENU → **iA** **iA+** [Intelligent Auto] → [Intelligent Auto Mode]

2 Press ▲/▼ to select [**iA+**] or [**iA**] and then press [MENU/SET].



It is also possible to display the selection screen by touching the Recording Mode icon in recording screen.



Intelligent Auto Plus Mode allows you to adjust the settings below while also using Intelligent Auto Mode for other settings.

	iA+ Intelligent Auto Plus Mode	iA Intelligent Auto Mode
Setting the brightness	○	—
Setting the colour tone	○	—
Defocus Control	○	—
Menus that can be set	Many	Few

■ AF, Face/Eye Detection, and Face Recognition

The AF Mode is automatically set to [AF]. If you touch the subject, the AF tracking function will work.

- The AF tracking function will also work if you press [AF] (◀) and then press the shutter button halfway.
- When [Face Recog.] is set to [ON], and the face similar to the registered face is detected, [R] is displayed in the top right of [AF], [AF] and [AF].



■ About the flash

• Open the flash when the flash is to be used. (P159)

When recording with the flash, the camera automatically selects [iA], [iA], [iS] or [iS] according to the type and brightness of the subject.

- When [iA] or [iS] is set, Red-Eye Removal is enabled.
- Shutter speed will be slower during [iS] or [iS].
- In Intelligent Auto Plus Mode, you can set [Flash Mode] to [☺] (forced flash off) in [Flash] of the [Rec] menu even with the flash open.

■ Scene Detection

- Use a tripod or similar support when the scene detection has been identified as [S]. When the camera has judged that camera shake is minimal, the shutter speed becomes slower than normal.
Take care not to move the camera while taking pictures.
- Depending on recording conditions, different scene types may be selected for the same subject.



The Backlight Compensation

When there is a backlight, the subject appears darker and the camera will automatically attempt to correct it by increasing the brightness of the picture.

Backlight Compensation works automatically in Intelligent Auto Plus Mode or Intelligent Auto Mode.

[Intelligent Auto] menu

Taking handheld shots of night scenes ([iHandheld Night Shot])

When [F₂] is detected while taking handheld night shots, pictures of the night scenery will be taken at a high burst speed and composed into a single picture.

MENU →  [Intelligent Auto] → [iHandheld Night Shot] → [ON]/[OFF]

- The angle of view will be slightly narrower.
- Do not move the camera during the continuous shooting after pressing the shutter button.
- Flash is fixed to [☺] (forced flash off).

Combining pictures into a single picture with rich gradation ([iHDR])

When there is, for example, strong contrast between the background and the subject, multiple still pictures are recorded with differing exposures and combined to create a single still picture rich in gradation.

[iHDR] works automatically as needed. When it does, [HDR] is displayed on the screen.

MENU →  [Intelligent Auto] → [iHDR] → [ON]/[OFF]

- The angle of view will be slightly narrower.
- Do not move the camera during the continuous shooting after pressing the shutter button.
- You cannot take the next picture until the combination of pictures is complete.
- A moving subject may be recorded with unnatural blurs.



Not available in these cases:

- [iHandheld Night Shot]/[iHDR] do not work for the pictures taken during a motion picture recording.
- [iHandheld Night Shot]/[iHDR] are not available in the following cases:
 - When recording in Burst Mode
 - When recording 4K photos
 - When recording with the Post Focus function
 - When recording with the Bracket function
 - When [Quality] is set to [RAW_{III}], [RAW_{II}] or [RAW]
 - When [Ex. Tele Conv.] in the [Rec] menu is set
 - When using [Time Lapse Shot]
 - When using [Stop Motion Animation] (only when [Auto Shooting] is set)
- [iHDR] is not available in the following cases:
 - When recording using the flash

Taking pictures with customised colour, defocus control, and brightness settings



Recording Mode: 

■ Setting colour

- 1 Press [WB].
- 2 Rotate the rear dial to adjust colour.
 - To return to the recording screen, press [WB] again.
 - The colour setting will return to the default level (centre point) when this unit is turned off or the camera is switched to another Recording Mode.





■ Taking a picture with a blurred background (Defocus Control)

- 1 Press [] to display the brightness setting screen.
- 2 Press the Fn button (Fn1) to display the setting screen.
- 3 Set the blurriness by rotating the rear dial.
 - To return to the recording screen, press [MENU/SET].
 - To cancel the setting, press [Fn2] on the blurriness setting screen.
 - AF Mode is set to [].
The position of the AF area can be set by touching the screen. (Its size cannot be changed)





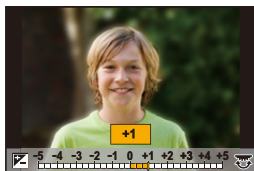

■ Setting brightness

- 1 Press [].
- 2 Rotate the rear dial to adjust brightness.
 - In the [Custom] ([Operation]) menu, [Exposure Comp. Disp. Setting], you can change the functions to be set on the exposure compensation screen. (P46)
 - To return to the recording screen, press [] again.



Change the settings by using the touch screen

- 1 Touch [].
- 2 Touch the item you want to set.
 - []: Colour tone
 - []: Defocus level
 - []: Brightness
- 3 Drag the slide bar to set.
 - To return to the recording screen, press [MENU/SET].



- Depending on the lens used, you may hear a sound from the lens while operating Defocus Control. This is due to the aperture operation of the lens and is not a malfunction.
- Depending on the lens used, operational sound of the Defocus Control may be recorded during the recording of a motion picture when the function is used.



Programme AE Mode

Recording Mode: **[P]**

The camera automatically sets the shutter speed and the aperture value according to the brightness of the subject.

You can take pictures with greater freedom by changing various settings in the [Rec] menu.

- 1** Set the mode dial to [P].
- 2** Press the shutter button halfway and display the aperture value and shutter speed value on the screen.

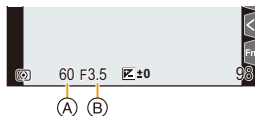

- (A) Shutter speed
- (B) Aperture value

- If the exposure is not adequate, the aperture value and shutter speed turn red and blink.

■ Programme Shift

You can change the preset aperture value and shutter speed without changing the exposure. This is called Programme Shift.

It enables you to, for example, make the background more defocused by decreasing the aperture value or capture a moving subject more dynamically by slowing the shutter speed.

- 1** Press the shutter button halfway and display the aperture value and shutter speed value on the screen.
- 2** While the values are displayed (about 10 seconds), perform Programme Shift by rotating the rear dial or front dial.

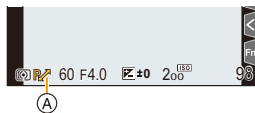

- (A) Programme Shift indication

- To cancel Programme Shift, perform either of the following operations:
 - Turn off the camera.
 - Rotate the front/rear dial until the Programme Shift indication disappears.

Not available in these cases:

- Programme Shift is not available in the following cases:
 - When recording using the flash
 - When recording 4K photos
 - When recording with the Post Focus function
 - When the ISO sensitivity is set to [ISO]



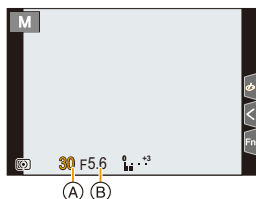

Taking Pictures by Specifying the Aperture/ Shutter Speed

Recording Mode: **A S M**

(Example: In Manual Exposure Mode)



- (A) Shutter speed
- (B) Aperture value

<p>Aperture value</p>	 <p>Small It becomes easier to defocus the background.</p>	 <p>Large It becomes easier to maintain focus as far as the background.</p>
<p>Shutter speed</p>	 <p>Slow It becomes easier to express movement.</p>	 <p>Fast It becomes easier to freeze movement.</p>

- The effects of the set aperture value and shutter speed will not be visible on the recording screen. To check on the recording screen, please use [Preview]. (P78)
- The brightness of the screen and the recorded pictures may differ. Check the pictures on the playback screen.
- If the exposure is not adequate, the aperture value and the shutter speed turn red and blink when the shutter button is pressed halfway.

Aperture-Priority AE Mode

When you set the aperture value, the camera automatically optimises the shutter speed for the brightness of the subject.

- 1 Set the mode dial to [A].
- 2 Set the aperture value by rotating the rear dial or the front dial.

(A) Aperture value

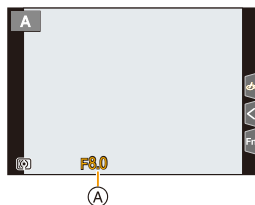

- When using a lens with an aperture ring, set the position of the aperture ring to other than [A] to use the aperture value of the lens.

Shutter-Priority AE Mode

When you set the shutter speed, the camera automatically optimises the aperture value for the brightness of the subject.

- 1 Set the mode dial to [S].
- 2 Set the shutter speed by rotating the rear dial or the front dial.

(A) Shutter speed

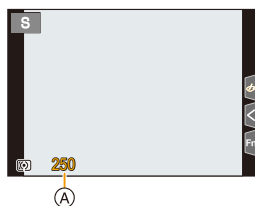

- When the flash is activated, the fastest shutter speed that can be selected is 1/200 of a second. (P162)

Manual Exposure Mode

Determine the exposure by manually setting the aperture value and the shutter speed.

- 1 Set the mode dial to [M].
- 2 Rotate the rear dial to set the shutter speed, and rotate the front dial to set the aperture value.

- (A) Shutter speed
- (B) Aperture value
- (C) Manual Exposure Assistance

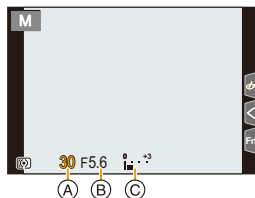

Available Shutter Speed (Sec.)

When the mechanical shutter is used	[B] (Bulb), 60 to 1/4000
When the Electronic Front Curtain is used	[B] (Bulb), 60 to 1/2000
When the electronic shutter is used	1 to 1/16000

- When using the mechanical shutter or the electronic front curtain, you can set [B] (Bulb) and then [LC] (Live View Composite) by rotating the rear dial to the left.
For information about Live View Composite recording, refer to page 76.



Optimising the ISO sensitivity for the shutter speed and aperture value

When the ISO sensitivity is set to [AUTO], it will be adjusted according to the shutter speed and aperture value.

- Depending on recording conditions, an appropriate exposure may not be set or the ISO sensitivity may become higher.

Manual Exposure Assistance

When the ISO sensitivity is set to other than [AUTO], Manual Exposure Assistance will be displayed on the recording screen.

	The exposure is adequate.
	Set to faster shutter speed or larger aperture value.
	Set to slower shutter speed or smaller aperture value.

- The Manual Exposure Assistance is an approximation. We recommend checking the pictures on the playback screen.

- When using a lens having an aperture ring, set the position of the aperture ring to [A] to activate the front/rear dial settings. At positions other than [A], the ring setting takes priority.
- When the flash is activated, the fastest shutter speed that can be selected is 1/200 of a second. (P162)

Bulb recording

Recording Mode: **[M]**

If you set the shutter speed to [B] (Bulb) during manual mode, the shutter stays open while the shutter button is pressed and held fully. (Up to approximately 30 minutes)

The shutter closes if you release the shutter button.

Use this when you want to keep the shutter open for a long time to take pictures of fireworks, a night scene etc.



- We recommend using a tripod or the shutter remote control (DMW-RS2: optional) when you take pictures with the shutter speed set to [B].
- When you take pictures with the shutter speed set to [B], noise may become visible. To avoid picture noise, we recommend setting [Long Shtr NR] in the [Rec] menu to [ON] before taking pictures.



Not available in these cases:

- This function is not available in the following cases:
 - When recording using the flash (only when [Flash Synchro] is set to [2ND])
 - When recording 4K photos
 - When recording with the Post Focus function
 - When recording with the Bracket function
 - When [Silent Mode] is set to [ON]
 - When using the electronic shutter
 - When [HDR] is set to [ON]
 - When using [Time Lapse Shot]
 - When using [Stop Motion Animation] (only when [Auto Shooting] is set)

Live View Composite Recording

Recording Mode: [M]

The camera records images at set exposure time intervals, and combines parts with changes in bright light to save the result as one picture.

A combined image is displayed at each exposure time interval, so you can keep recording while checking results.

With its ability to take pictures with reduced overall brightness, this function is useful for capturing the light trails of stars and fireworks with bright night scenery in the background.

- 1 **Set the mode dial to [M].**
- 2 **Rotate the rear dial to set the shutter speed to [LC].**
- 3 **Select the menu.**

MENU →  **[Rec]** → **[Live View Composite]**

- After switching the shutter speed to [LC], pressing [MENU/SET] will display the menu with [Live View Composite] selected. (It displays in this state only once after switching the shutter speed to [LC].)

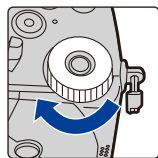

- 4 **Select the exposure time per frame (shutter speed).**
 - This can be set in a range of [1/2 SEC] to [60 SEC].
 - Press the shutter button halfway to return to the recording screen.
- 5 **Press the shutter button fully to obtain an image with reduced noise.**
 - A countdown screen is displayed. Wait until this step completes.
- 6 **Press the shutter button fully to start recording.**
 - Images are combined every time the exposure time set in step 4 has passed.
- 7 **Press the shutter button fully again to stop recording.**
 - This will run noise reduction and save the image.
 - Live View Composite can record up to 3 hours per recording. (Recording stops automatically when the recording time exceeds 3 hours.)

■ Screen indications during recording

- Histogram display**
 - After following step 5, this is displayed automatically.
- Exposure time per frame × Number of pictures combined**
- Elapsed time**
 - The time is updated with each increase in the number of pictures combined.

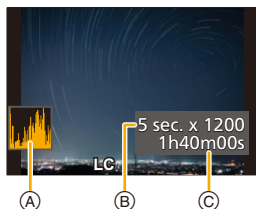

- We recommend using a tripod or the Shutter Remote Control (DMW-RS2: optional) for Live View Composite recording.
- We recommend that you use a sufficiently charged battery or an AC adaptor (optional) and DC coupler (optional).

- [Long Shtr NR] is fixed to [ON].
- After an image for noise reduction is obtained, some menus are not displayed.
- The image for noise reduction will be discarded if the following operations are performed. Follow step **5** again.
 - Setting [Live View Composite]
 - Changing the ISO sensitivity
 - Switching to Playback Mode
 - Starting motion picture recording
 - Changing the Recording Mode
 - Changing the drive mode
- When the shutter button is pressed fully to stop recording, the last image will not be included in the combined image.

 **Not available in these cases:**

- This function is not available in the following cases:
 - When recording using the flash (only when [Flash Synchro] is set to [2ND])
 - When recording in Burst Mode
 - When recording 4K photos
 - When recording with the Post Focus function
 - When recording with the Bracket function
 - When using [Filter Settings]
 - When [Silent Mode] is set to [ON]
 - When [Shutter Type] is set to [ESHTR]
 - When [HDR] is set to [ON]
 - When using [Time Lapse Shot]
 - When using [Stop Motion Animation]
 - When using [Multi Exp.]

Preview Mode

Applicable modes:   **P** **A** **S** **M**   

- **Confirm the effects of aperture:** You can check the depth of field (effective focus range) before taking a picture by closing the diaphragm blades to the aperture value you set.
- **Confirm the effects of shutter speed:** Movement can be confirmed by displaying the actual picture that will be taken with that shutter speed.

Touch [Fn5] to switch between different effect preview screens.

- [Preview] is assigned to [Fn5] by default. (P60)



Normal recording screen



Aperture effect preview screen
Aperture effect: On
Shutter speed effect: Off



Shutter speed effect preview screen
Aperture effect: On
Shutter speed effect: On



Depth of field properties

*1	Aperture value	Small	Large
	Focus length	Tele	Wide
	Distance to the subject	Near	Distant
Depth of field (effective focus range)		Shallow (Narrow)*2	Deep (Wide)*3

*1 Recording conditions

*2 Example: When you want to take a picture with a blurred background etc.

*3 Example: When you want to take a picture with everything in focus including the background etc.

• It is possible to record while in Preview Mode.

• Range for shutter speed effect check is 8 seconds to 1/16000 of a second.



Not available in these cases:



• Preview Mode is not available when recording with [4K Pre-Burst].

One Push AE

Applicable modes:   **P** **A** **S** **M**   

When the exposure setting is too bright or too dark, you can use one push AE to achieve a suitable exposure setting.

How to tell if the exposure is not adequate

- If the aperture values and shutter speed blink red when the shutter button is pressed halfway.
- If the Manual Exposure Assistance (P74) is anything other than   when in Manual Exposure mode.

- 1 Set a Fn button to [One Push AE]. (P60)
- 2 (When exposure is not adequate)
Press Fn button.



Blink red



The exposure is changed to give a suitable exposure.

- The aperture and shutter speed change to the settings adjusted for the correct exposure.
- In the following cases, suitable exposure cannot be set.
 - When the subject is extremely dark and it is not possible to achieve adequate exposure by changing the aperture value or shutter speed
 - When recording using the flash
 - In Preview Mode
 - When using a lens that includes an aperture ring

Custom Mode

Recording Mode: **C1** **C2**

Registering custom settings

Up to 4 sets of current camera settings can be registered using [Cust.Set Mem.].
(C1, C2-1, C2-2, C2-3)

Initial setting of the Programme AE Mode is registered as the custom settings initially.

Preparation:

Set to recording mode and menu settings of the state you wish to save.

MENU →  **[Setup]** → **[Cust.Set Mem.]** →

Custom set where you want to register settings

- You can register up to three custom sets to [C2] of the mode dial.
- The following menu items are not registered as custom settings.

[Custom] menu	[Setup] menu
– [Menu Guide] – Data registered with [Face Recog.] – The [Profile Setup] setting	– All menus
	[Playback] menu
	– All menus

Using Custom Mode

Set the mode dial to [C1] or [C2].

- If you set the mode dial to [C2], the last used custom set will be called up.

■ To change a custom set in [C2] ([Custom Mode] menu)

- 1 Set the mode dial to [C2].
- 2 Select the menu.

MENU → **C [Custom Mode]**

- 3 Press ▲/▼ to select the custom setting you want to use, and then press [MENU/SET].

- The settings are switched to those settings you selected for the custom set.



It is also possible to display the selection screen by touching the Recording Mode icon in recording screen.



■ Changing the registered content

Registered contents do not change when the menu setting is changed temporarily with the mode dial set to [C1] or [C2]. To change the registered settings, overwrite the registered content using [Cust.Set Mem.] on the [Setup] menu.

Scene Guide Mode

Recording Mode: 

If you select a scene to suit the subject and recording conditions with reference to the example images, the camera will set optimal exposure, colour, and focus, allowing you to record in a manner appropriate to the scene.

1 Set the mode dial to [].

2 Press ◀/▶ to select the scene.

- The scene can also be selected by dragging an example image or the slide bar.

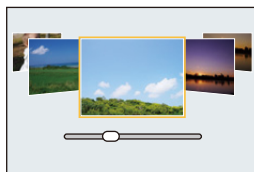

3 Press [MENU/SET].



It is also possible to display the selection screen by touching the Recording Mode icon in recording screen.



- Depending on the scene, the recording screen may seem as if frames are missed.
- To change the Scene Guide Mode, select [Scene Switch] in the Scene Guide Menu. This will return you to step **2** above.
- Some items in the [Rec] menu are not available in Scene Guide Mode as the camera automatically makes optimisation adjustments.
- Although White Balance is fixed to [AWB] for certain types of scene, you can fine tune the White Balance (P117) or use White Balance bracketing (P147) by pressing [WB] button on the recording screen.

Types of Scene Guide Mode



Displaying the description of each scene and recording tips

Press **[DISP.]** while the scene selection screen is displayed.

- When it is set to the guide display, detailed explanations and tips for each scene are displayed.

Normal display

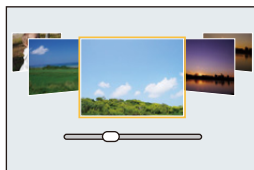

Guide display

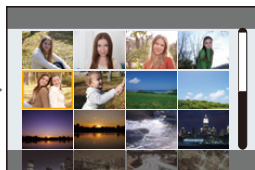
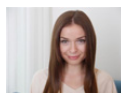

List display

**[Clear Portrait]****[Silky Skin]**

- The smoothing effect is applied to the part that has a similar tone to the complexion of a subject, as well.
- This mode may not be effective under insufficient lighting.

**[Backlit Softness]****[Clear in Backlight]****[Relaxing Tone]****[Sweet Child's Face]**

Touch the face.

- A still picture is recorded with the focus and exposure set for the touched location.

**[Distinct Scenery]****[Bright Blue Sky]****[Romantic Sunset Glow]****[Vivid Sunset Glow]**

**[Glistening Water]**

- Star filter used in this mode may cause glistening effects on the objects other than water surface.

**[Cool Night Sky]****[Artistic Nightscape]****[Handheld Night Shot]**

- Do not move the unit during the continuous shooting after pressing the shutter button.
- The angle of view will be slightly narrower.

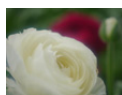
**[Soft Image of a Flower]**

- For close-up recording, we recommend that you do not use the flash.

**[Cute Dessert]**

- For close-up recording, we recommend that you do not use the flash.

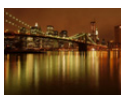
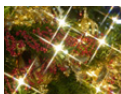
**[Clear Sports Shot]****[Panorama Shot]****[Clear Nightscape]****[Warm Glowing Nightscape]****[Glittering Illuminations]****[Clear Night Portrait]**

- We recommend using a tripod and the self-timer.
- When [Clear Night Portrait] is selected, keep the subject still for about 1 second after taking the picture.

**[Appetizing Food]**

- For close-up recording, we recommend that you do not use the flash.

**[Freeze Animal Motion]**

- The initial setting for the AF assist lamp is [OFF].

**[Monochrome]**

MENU



[Panorama Shot]

Consecutive photos taken while the camera is moved are combined to form a panorama.

Preparation: Set the Scene Guide Mode to [Panorama Shot].

- 1 Press the shutter button halfway to focus.
- 2 Press the shutter button fully and move the camera in a small circle in the direction of the arrow on the screen.

Recording from left to right



Image size: [STANDARD]

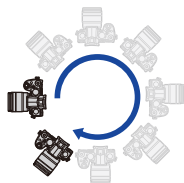

Image size: [WIDE]



- (A) Recording direction and panning (Guide)
 (B) Horizontal/vertical guide

- Move the camera at a constant speed.
 Pictures may not be able to be recorded properly if the camera is moved too fast or slow.

- 3 Press the shutter button once again to end the picture recording.
 - Recording can also be ended by keeping the camera still while recording.
 - Recording can also be ended by moving the camera to the end of the guide.

■ Changing panorama picture settings

MENU → [Rec] → [Panorama Settings]

[Direction]	Sets the recording direction.
[Picture Size]	Sets the angle of view (image size). [STANDARD]/[WIDE]

- The number of recording pixels in the horizontal and vertical directions of the panorama picture varies depending on the image size, the recording direction and the number of combined pictures.

The maximum number of pixels is shown below.

Image size	Recording direction	Horizontal Resolution	Vertical Resolution
[STANDARD]	Horizontal	8176 pixels	1920 pixels
	Vertical	2560 pixels	7680 pixels
[WIDE]	Horizontal	8176 pixels	960 pixels
	Vertical	1280 pixels	7680 pixels

■ Technique for Panorama Shot Mode



- (A) Move the camera in the recording direction without shaking it.
(If the camera shakes too much, pictures may not be recorded, or the created panorama picture may become narrower (smaller).)
- (B) Move the camera towards the edge of the range you wish to record.
(However, the last frame is not recorded to the end.)

■ About playback

Pressing ▲ will start scrolling playback automatically in the same direction as the recording.

- The following operations can be performed during scrolling playback.

		Start panorama playback/Pause*
		Stop



- * When the playback is paused, you can scroll forwards and backwards by dragging the screen.
When the scroll bar is touched, the playback position jumps to the touched position.

- When the focal length is long, such as when a telephoto lens is attached, move the camera slowly.
- The focus, White Balance, and exposure are fixed at the optimum values for the first picture. As a result, if the focus or brightness changes substantially during recording, the entire panorama picture may not be recorded at the suitable focus or brightness.
- When multiple pictures are combined to create a single panorama picture, the subject may appear distorted or the connection points may be noticeable in some cases.

Not available in these cases:

- A panorama picture may not be able to be created, or the pictures may not be combined properly when recording the following subjects or under the recording conditions below.
 - Subjects with a single, uniform colour or repetitive pattern (such as the sky or a beach)
 - Moving subjects (person, pet, car, waves, flowers blowing in the breeze, etc.)
 - Subjects where the colour or patterns change in a short time (such as an image appearing on a display)
 - Dark places
 - Locations with flickering light sources such as fluorescent lights or candles

Creative Control Mode

Recording Mode: 

You can set the effects to add by selecting example images and checking them on the screen.

- 1 Set the mode dial to [C].
- 2 Press ▲/▼ to select the image effects (filters).

(A) Preview display

- You can also select the image effects (filters) by touching the example images.



- It is also possible to display the selection screen by touching the Recording Mode icon in recording screen.

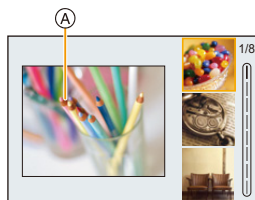

- 3 Press [MENU/SET].



Displaying the description of each image effect

Press [DISP.] while the image effect selection screen is displayed.

- When it is set to the guide display, explanations for each picture effect are displayed.

Normal display

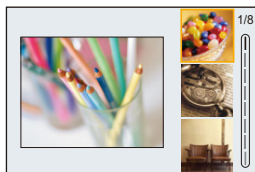

Guide display

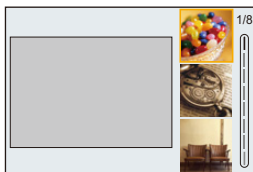

List display

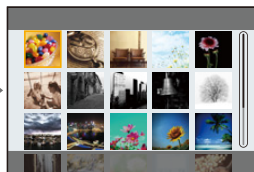

- White Balance will be fixed to [AWB], and [Sensitivity] will be fixed to [AUTO].
- Depending on the image effect, the recording screen may seem as if frames are missed.

■ [Creative Control] menu

The menus below are available in Creative Control Mode.

MENU →  **[Creative Control]**



[Filter Effect]	Displays the image effect (filter) selection screen.
[Simultaneous Record w/o Filter]	Allows you to set the camera to take a picture with and without an image effect simultaneously.

Types of image effects

 [Expressive]	 [Retro]	 [Old Days]
 [High Key]	 [Low Key]	 [Sepia]
 [Monochrome]	 [Dynamic Monochrome]	 [Rough Monochrome]
 [Silky Monochrome]	 [Impressive Art]	 [High Dynamic]
 [Cross Process]	 [Toy Effect]	 [Toy Pop]
 [Bleach Bypass]	 [Miniature Effect]	 [Soft Focus]
 [Fantasy]	 [Star Filter]	 [One Point Color]
 [Sunshine]		

■ Setting the type of defocus ([Miniature Effect])

1 Press ▲ to display the setting screen.

- Setting screen can also be displayed by touching in order of [] then [].

2 Press ▲/▼ or ◀/▶ to move the in-focus portion.

- You can also move the in-focus portion by touching the screen on the recording screen.
- To set the recording orientation (defocus orientation), touch [].



3 Rotate the rear dial to change the size of in-focus portion.

- The portion can also be enlarged/reduced by pinching out/pinching in the screen.
- To reset the in-focus portion setting to the default, press [DISP.].

4 Press [MENU/SET] to set.

- No sound is recorded in motion pictures.
- Approximately 1/8 of the time period is recorded.
(If you record for 8 minutes, the resulting motion picture recording will be approximately 1 minute long.)



The displayed available recording time is approximately 8 times.

Depending on the recording frame rate of the motion picture, the recording time of the motion picture and the available recording time may differ from the values above.

- If you end motion picture recording after a short time, the camera may go on recording for a certain period.

■ Set the colour to leave in ([One Point Color])

1 Press ▲ to display the setting screen.

- Setting screen can also be displayed by touching in order of [] then [].

2 Select the colour you want to leave by moving the frame with ▲/▼/◀/▶.



- You can also select the colour you want to leave by touching the screen.
- To return the frame back to the centre, press [DISP.].

3 Press [MENU/SET] to set.



- Depending on the subject, the set colour may not be left in.

■ Setting the position and size of the light source ([Sunshine])

- 1 Press **▲** to display the setting screen.
 - Setting screen can also be displayed by touching in order of [] then [].
- 2 Press **▲/▼/◀/▶** to move the centre position of the light source.
 - The position of the light source can also be moved by touching the screen.



Point for when placing the centre of the light source

A more natural appearance can be created by placing the centre of the light source outside the image.



- 3 Adjust the size of the light source by rotating the rear dial.
 - The display can also be enlarged/reduced by pinching out/pinching in.
 - To reset the light source setting to the default, press [DISP.].
- 4 Press [MENU/SET] to set.

Adjust the effect to fit your preferences

- 1 Press [WB].
- 2 Rotate the rear dial to set.
 - To return to the recording screen, press [WB] again.

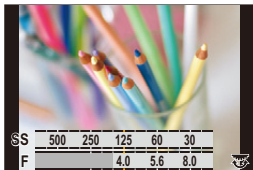

Image effect	Items that can be set		
[Expressive]	Freshness	Understated colours	↔ Pop colours
[Retro]	Colour	Yellowish tinge	↔ Reddish tinge
[Old Days]	Contrast	Low contrast	↔ High contrast
[High Key]	Colour	Pinkish tinge	↔ Aquamarinish tinge
[Low Key]	Colour	Reddish tinge	↔ Bluish tinge
[Sepia]	Contrast	Low contrast	↔ High contrast

Image effect	Items that can be set			
[Monochrome]	Colour	Yellowish tinge	Bluish tinge	
[Dynamic Monochrome]	Contrast	Low contrast	High contrast	
[Rough Monochrome]	Grittiness	Less gritty	Grittier	
[Silky Monochrome]	Extent of defocus	Weak defocus	Strong defocus	
[Impressive Art]	Freshness	Black and white	Pop colours	
[High Dynamic]	Freshness	Black and white	Pop colours	
[Cross Process]	Colour	Greenish tinge/Bluish tinge/Yellowish tinge/ Reddish tinge		
[Toy Effect]	Colour	Orangish tinge	Bluish tinge	
[Toy Pop]	Area with reduced peripheral brightness	Small	Large	
[Bleach Bypass]	Contrast	Low contrast	High contrast	
[Miniature Effect]	Freshness	Understated colours	Pop colours	
[Soft Focus]	Extent of defocus	Weak defocus	Strong defocus	
[Fantasy]	Freshness	Understated colours	Pop colours	
[Star Filter]		Length of the rays of light Short		Long
		Number of the rays of light Smaller		Larger
		Angle of the rays of light Rotate to the left		Rotate to the right
[One Point Color]	Amount of colour left	Small amount of colour	Large amount of colour	
[Sunshine]	Colour	Yellowish tinge/Reddish tinge/ Bluish tinge/Whitish tinge		

Taking a picture with a blurred background (Defocus Control)



- 1 Press [] to display the brightness setting screen.
- 2 Press the Fn button (Fn1) to display the setting screen.
- 3 Rotate the rear dial to set.
 - To return to the recording screen, press [MENU/SET].
 - To cancel the setting, press [Fn2] on the blurriness setting screen.



Not available in these cases:



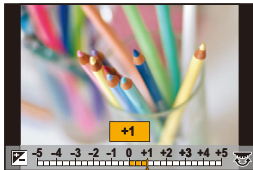

- This function is not available in the following case:
 - [Miniature Effect] (Creative Control Mode)

Setting brightness

- 1 Press [].
- 2 Rotate the rear dial to set.
 - In the [Custom] ([Operation]) menu, [Exposure Comp. Disp. Setting], you can change the functions to be set on the exposure compensation screen. (P46)
 - To return to the recording screen, press [] again.



■ Change the settings by using the touch screen

- 1 Touch [].
- 2 Touch the item you want to set.
 - []: Adjusts an image effect
 - []: Defocus level
 - []: Brightness
- 3 Drag the slide bar to set.
 - To return to the recording screen, press [MENU/SET].



4.

Focus, Brightness (Exposure) and Colour tone Settings

Using AF

AF (Auto Focus) refers to automatic focusing.

Select the focus mode and the AF mode appropriate for the subject and scene.

- 1 Set the focus mode lever to [AFS/AFF] or [AFC].

- The Focus Mode will be set. (P95)

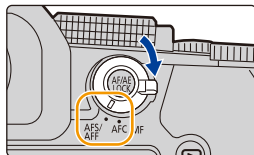

- 2 Press [MENU] (◀).

- 3 Press ◀/▶ to select AF Mode and then press [MENU/SET].

- The AF Mode will be set. (P97)

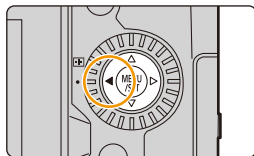

- 4 Press the shutter button halfway.

- AF will be activated.

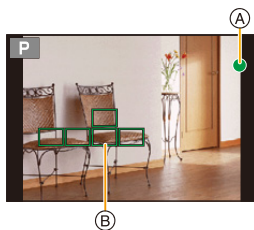

Focus	When the subject is focused	When the subject is not focused
Focus indication (A)	On	Blinks
AF area (B)	Green	—
Sound	Beeps 2 times	—

- The focus indication is displayed as [●_{LOW}] in a dark environment, and focusing may take longer than usual.
- If the camera detects stars in the night sky after displaying [●_{LOW}], Starlight AF will be activated. When focus is achieved, the focus indication [●_{STAR}] and AF areas in focus are displayed. (Starlight AF cannot perform detection on the edges of the screen.)

- If you zoom in/out after focusing on a subject, the focus may lose its accuracy. In that case, re-adjust the focus.



Subjects and recording conditions which are difficult to focus

- Fast-moving subjects, extremely bright subjects or subjects without contrast.
- When recording subjects through windows or near shiny objects.
- When it is dark or when jitter occurs.
- When the camera is too close to the subject or when taking a picture of both distant and near subjects.



How to adjust the composition while pressing the shutter button halfway

When recording with [■], follow the steps below if the subject is not in the centre of the composition of the picture you want to take. (When the focus mode is set to [AFS])

- 1 Aim the AF area over the subject.
- 2 Press the shutter button halfway.
 - This will lock the focus and exposure.
- 3 While continuing to press and hold the shutter button halfway, move the camera to compose the picture you want to take.
- 4 Press the shutter button to take the picture.



Setting the Focus Mode (AFS/AFF/AFC)

Applicable modes: 

The method for achieving focus when the shutter button is pressed halfway is set.

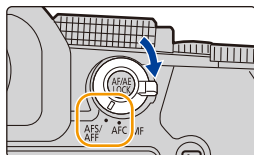
Set the focus mode lever.



Item		Recommended recording scenes	
[AFS/ AFF]	[AFS]	Subject is still (Scenery, anniversary photograph, etc.)	“AFS” is an abbreviation of “Auto Focus Single”. The focus stays locked while the shutter button is pressed halfway, so you can perform recording while changing the composition.
	[AFF]	Movement cannot be predicted (Children, pets, etc.)	“AFF” is an abbreviation of “Auto Focus Flexible”. If the subject moves while the shutter button is pressed halfway, the focus is readjusted automatically according to the movement of the subject.
		You can set the menu to change the setting. MENU →  [Rec]/  [Motion Picture] → [AFS/AFF] Settings: [AFS]/[AFF]	
	[AFC]	Subject is moving (Sport, trains, etc.)	“AFC” is an abbreviation of “Auto Focus Continuous”. In this mode, while the shutter button is pressed halfway, focusing is constantly performed to match the movement of the subject.



When recording using [AFF], [AFC]

- This predicts the movement of the subject, maintaining focusing. (Movement prediction)
- It may take time to focus on the subject when you operate the zoom from Wide to Tele or suddenly change the subject from a distant one to a nearby one.
- Press the shutter button halfway again when it is difficult to focus on the subject.
- While the shutter button is pressed and held halfway, shake may be seen on the screen.

- Focus Mode settings of [AFF] and [AFC] work in the same manner as [AFS] in the following situations:
 - Creative Video Mode
 - When recording with [4K Burst(S/S)]
 - In low light situations
- The setting is fixed to [AFS] when the Scene Guide Mode is set to [Panorama Shot].
- [AFF] is not available when recording 4K photos. [Continuous AF] works during recording.
- The Focus Mode setting cannot be changed when recording is performed with the Post Focus function.

[AF Sensitivity(Photo)]

Applicable modes: **P** **A** **S** **M**

Sets the sensitivity to be applied when adjusting the focus according to the movement of the subject.

Preparation:

The focus mode is set to [AFF] or [AFC]. (P95)

MENU → [Rec] → **[AF Sensitivity(Photo)]**

Settings: [+2], [+1], [±0], [-1], [-2]

+	When the distance to the subject changes drastically, the camera re-adjusts the focus immediately. You can bring different subjects into focus one after another.
-	When the distance to the subject changes drastically, the camera waits for a short period of time before re-adjusting the focus. This allows you to prevent the focus from being accidentally re-adjusted when, for example, an object moves across the image.

Not available in these cases:

- This function is not available in the following cases:
 - [Panorama Shot] (Scene Guide Mode)
 - When recording 4K photos
 - When recording with the Post Focus function

Selecting the AF Mode





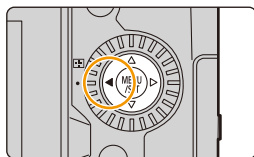

Applicable modes:   **P** **A** **S** **M**    

This allows the focusing method that suits the positions and number of the subjects to be selected.

1 Press [] (◀).

2 Press ◀/▶ to select the AF mode and then press [MENU/SET].



 [[Face/Eye Detection]]	<p>The camera automatically detects the faces and eyes of subjects. The camera adjusts the focus on the eye that is closer to the camera and the exposure using the face (when [Metering Mode] is set to [☉]). (P98)</p>	
 [[Tracking]]	<p>The camera keeps adjusting the focus and exposure automatically to the specified moving object. (Dynamic Tracking) (When [Metering Mode] is set to [☉]) (P98)</p>	
 [[49-Area]]	<p>Up to 49 AF areas can be focused. This is effective when a subject is not in the centre of the screen.</p>	
 [[Custom Multi]]	<p>From among 49 AF areas, you can freely set the optimum shape of the AF area for the subject. (P99)</p>	
 [[1-Area]]	<p>The camera focuses on the subject in the AF area on the screen.</p>	
 [[Pinpoint]]	<p>You can achieve a more precise focus on a point that is smaller than []. If you press the shutter button halfway, the screen that lets you check the focus will be enlarged.</p>	

• In Intelligent Auto Mode and Intelligent Auto Plus Mode, you can switch to either [] or [].

About [👤] ([Face/Eye Detection])

When the camera detects faces, AF areas are displayed and the eye to be brought into focus are indicated.

(A): Eye used for focusing

Yellow: The colour changes to green when the shutter button is pressed halfway and focus is achieved.

White: This is displayed when more than one face is detected. Faces that are at the same distance as the face inside the yellow AF area will be brought into focus.

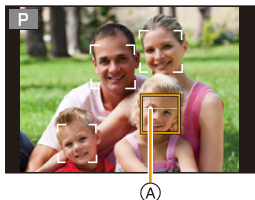

- The camera can detect the faces of up to 15 people.
- Only the eyes of the face to be brought into focus can be detected.

Changing the eye to be brought into focus

Touch the eye to be brought into focus.

- Touching [👁️ AF] or pressing [MENU/SET] will cancel the setting of the eye that has been brought into focus.

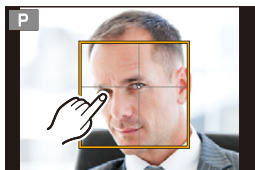

Locking the subject to be tracked ([👁️ AF] ([Tracking]))

Button operation

Aim the AF Tracking area (B) over the subject and then press the shutter button halfway.

- The AF area turns green when the subject is detected.
- The AF area turns yellow when you release the shutter button.
- Press [MENU/SET] to clear the lock.

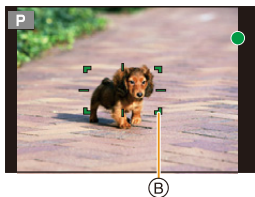

Touch operation

Touch the subject.

- Perform this operation with the Touch Shutter function cancelled.
- The AF Tracking area turns yellow while the subject is locked.
- Touch [👁️ AF] to clear the lock.



- The AF Tracking area will blink in red and then disappear if the lock fails.

Setting the shape of the AF area ([Custom Multi])

- 1 Press [] (◀).
- 2 Select a Custom Multi icon ([], etc.), and press ▲.
- 3 Press ◀/▶ to select a setting and then press ▼.

(A) The current shape of the AF area

<p>([Horizontal Pattern])</p>	<p>This shape is convenient for taking panning shots or similar shots.</p>	
<p>([Vertical Pattern])</p>	<p>This shape is convenient for recording objects, such as buildings.</p>	
<p>([Central Pattern])</p>	<p>This shape is convenient when you want to bring the centre area into focus.</p>	
<p>([Custom1]/[Custom2]/[Custom3])</p>	<p>You can select a customised setting.</p>	

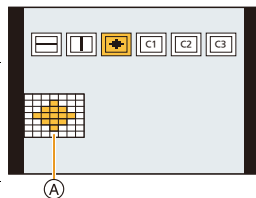

- The AF area setting screen is displayed.

4 Select AF areas.

(B) The selected AF areas

When selecting []/[]/[]

- 1 Change the shape of an AF area.

Button operation	Touch operation	Description of operation
▲/▼/◀/▶	Touching	Moves the position
	Pinching out/in	Changes the size
[DISP.]	[Reset]	First time: The position is reset to the centre Second time: The size is reset to the default

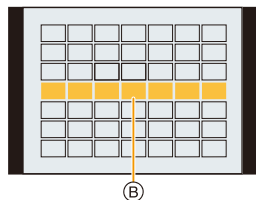

- 2 Press [MENU/SET] to set.

When selecting [C1]/[C2]/[C3]

- 1 Change the shape of an AF area.

Button operation

Press ▲/▼/◀/▶ to select the AF area, and then press [MENU/SET] to set (repeat).

- The setting is cancelled when [MENU/SET] is pressed again.
- To cancel all selections, press [DISP].

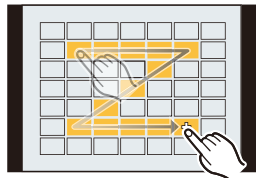

Touch operation

Touch or drag to select AF areas.

- To cancel the selection of a particular AF area, touch the area again.

- 2 Press the Fn button (Fn1) to set.

■ Registering the set AF area to [C1], [C2] or [C3]

- 1 On the screen in step 3 on P99, press ▲.
- 2 Press ▲/▼ to select a destination to which the setting will be registered, and press [MENU/SET].

- Turning off this unit will return the setting adjusted with [.....]/[]/[⊕] back to the default setting.

Restrictions on AF Mode

- The AF Mode is fixed to [□] in the following cases.
 - When using the Digital Zoom
 - [Miniature Effect] (Creative Control Mode)
 - The AF Mode is fixed to [👤] when [4K Live Cropping] is set.
 - It cannot be set the AF Mode in the following cases.
 - When recording with the Post Focus function
 - When [Pull Focus] in [Snap Movie] is set to [ON]
- 👤 ([Face/Eye Detection])**
- [👤] is not available in the following cases.
 - [Clear Nightscape]/[Cool Night Sky]/[Warm Glowing Nightscape]/[Artistic Nightscape]/[Glittering Illuminations]/[Handheld Night Shot]/[Appetizing Food]/[Cute Dessert] (Scene Guide Mode)
 - You cannot change the eye to bring into focus when [4K Live Cropping] is set.
 - The camera may not detect faces in certain situations, such as when the subjects are moving fast. In such situations, the camera performs the operation of [📷].

📷 ([Tracking])

- In situations where AF Tracking does not work correctly due to certain recording conditions, such as when the subject is small or the location is dark, the operation of [□] is performed.
- [📷] is not available in the following cases.
 - When using [Time Lapse Shot]
 - When recording with Live View Composite
- In the following cases, [📷] operates as [□].
 - [Glistening Water]/[Glittering Illuminations]/[Soft Image of a Flower]/[Monochrome] (Scene Guide Mode)
 - [Sepia]/[Monochrome]/[Dynamic Monochrome]/[Rough Monochrome]/[Silky Monochrome]/[Soft Focus]/[Star Filter]/[Sunshine] (Creative Control Mode)
 - [Monochrome]/[L.Monochrome]/[L.Monochrome D] ([Photo Style])

[+] ([Pinpoint])

- In the following case, [+] operates as [□].
 - When recording motion pictures
 - When recording 4K photos
- [+] is not available in the following cases.
 - [AFF]/[AFC] (Focus Mode)

AF area movement operation

Applicable modes: P A S M

When [], [], [] or [] in AF Mode is selected, you can change the position and size of the AF area. With [], you can set the lock-on position.

- Set the touch function to [] (Touch AF). (P53)
- You can also display the AF area setting screen by touching the recording screen.

MENU → [Custom] → [Operation] → [Touch Settings] → [Touch AF] → [AF]

- You can use the [Custom] ([Focus / Release Shutter]) menu to set the display method for the AF area according to your preference. (P213)

- The spot metering target can also be moved to match the AF area when the [Metering Mode] is set to [].

Not available in these cases:

- This function is not available in the following cases:
 - When using the Digital Zoom
 - When [4K Live Cropping] is set

When selecting [], [], []

- 1 Press [] (◀).
- 2 Select [], [] or [] and press ▼.
 - The AF area setting screen appears.

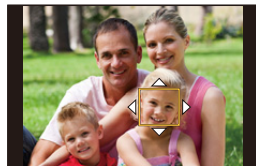

- 3 Change the position and size of the AF area.

Button operation	Touch operation	Description of operation
	Touching	Moves the position
	Pinching out/in	Changes the size (in small steps)*
/	–	Changes the size*
[DISP.]	[Reset]	First time: The position is reset to the centre Second time: The size is reset to the default*

* This operation is not available for [].

- 4 Press [MENU/SET] to set.

- If you have selected [], an AF area with the same function as [] will be set in the set position.

Setting of the AF area is cleared when [MENU/SET] is pressed or [] is touched.

When selecting [AF]

You can set the focus position by selecting an AF area group. The AF area, which is configured with 49 points, is divided into groups consisting of 9 points each (6 points or 4 points for the groups located at the edges of the screen).

- 1 Press [AF] (◀).
- 2 Select [AF] and press ▼.
 - The AF area setting screen appears.
- 3 Press ▲/▼/◀/▶ to select an AF area group.
- 4 Press [MENU/SET] to set.
 - Setting of the AF area is cleared when [MENU/SET] is pressed or [AF OFF] is touched.

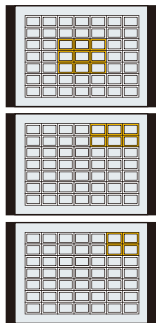

Examples of group



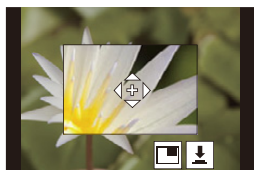

When selecting [+]

You can set the focus position precisely by enlarging the screen.

- 1 Press [] (◀).
- 2 Select [+] and press ▼.
- 3 Press ▲/▼/◀/▶ to set the focus position and then press [MENU/SET].
 - The enlarged display appears.



- 4 Move [+] to the position to be in focus.

Button operation	Touch operation	Description of operation
▲/▼/◀/▶	Touching	Moves [+].
	Pinching out/in	Enlarges/reduces the screen in small steps.
	—	Enlarges/reduces the screen.
		Switches the enlarged display (windowed/full screen). 
[DISP.]	[Reset]	Returns you to the screen in step 3.

- When the picture is displayed in windowed mode, you can enlarge the picture by approximately 3× to 6×; when the picture is displayed in full screen, you can enlarge the picture by approximately 3× to 20×.
- You can also take pictures by touching [].

- 5 Press [MENU/SET] to set.

- You cannot set the position to be in focus at the edges of the screen.

Specifying the AF area position with the Touch Pad

Applicable modes: P A S M

You can move the AF area displayed on the viewfinder by touching the monitor.



MENU → [Custom] → [Operation] → [Touch Settings] → [Touch Pad AF]

[EXACT]	Moves the AF area of the Viewfinder by touching a desired position on the Touch Pad.	
[OFFSET1] - [OFFSET7]	Moves the AF area of the viewfinder according to the distance you drag the touch pad. Operation area can be selected from 7 areas. Settings: [OFFSET1] (all areas) [OFFSET2] (right half) [OFFSET3] (upper right) [OFFSET4] (lower right) [OFFSET5] (left half) [OFFSET6] (upper left) [OFFSET7] (lower left)	Example: When set to [OFFSET1]
[OFF]	—	—

- Press the shutter button halfway to determine the focus position.
To return the focus position to the centre, press [DISP.] before determining the position. Press it again to reset the size to the initial setting.
- To cancel the AF area setting when , or is selected, press [MENU/SET].

- [Touch Pad AF] is not available in the following cases:
 - When [4K Live Cropping] is set
 - When [Pull Focus] in [Snap Movie] is set to [ON]

Adjusting focus and brightness for the touched position

Applicable modes:

MENU → [Custom] → [Operation] → [Touch Settings] → [Touch AF] → [AF+AE]

1 Touch the subject you want to optimise the brightness for.

- The AF area with the same function as is displayed on the touched position. (P102)
- The brightness optimisation position is displayed on the centre of the AF area. The position follows the movement of the AF area.
- [Metering Mode] is set to , which is used exclusively for the Touch AE.

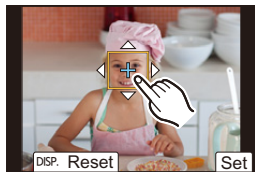

2 Touch [Set].

- To cancel the focus and brightness set with [AF+AE], touch () when is selected).



When the background has become too bright, etc., the brightness contrast with the background can be adjusted by compensating the exposure.



- When recording with the Touch Shutter, the focus and brightness are optimised for the touched position before recording takes place.
- At the edge of the screen, the metering may be affected by the brightness around the touched location.



Not available in these cases:

- The [AF+AE] does not function in the following case:
 - When using the Digital Zoom
 - When [4K Live Cropping] is set

Record Using MF

Applicable modes: 

MF (Manual Focus) refers to manual focusing.

Use this function when you want to fix the focus or when the distance between the lens and the subject is determined and you do not want to activate AF.

1 Set the focus mode lever to [MF].

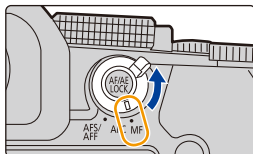

2 Press [] (◀).

3 Press ▲/▼/◀/▶ to adjust the focus position, and press [MENU/SET].

- The assist screen is displayed, enlarging the area. (MF Assist)
- You can also adjust the focus position by dragging the screen.
- You can also enlarge the area by performing one of the following operations:
 - Rotating the focus ring
 - Moving the focus lever
 - Pinching out or touching the screen twice

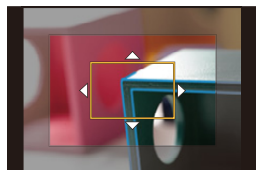

4 Adjust the focus.

The operations used to focus manually differ depending on the lens.

When using an interchangeable lens with a focus ring

Rotate to **A side:**

Focuses on nearby subject

Rotate to **B side:**

Focuses on distant subjects

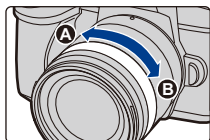

When using the interchangeable lens having a focus lever

Move to **C side:**

Focuses on nearby subject

Move to **D side:**

Focuses on distant subjects

- The focusing speed varies depending on how far you move the focus lever.

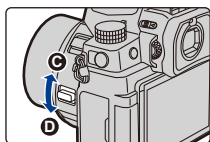

When using an interchangeable lens with no focus ringPress **▶**: Focuses on nearby subjectPress **◀**: Focuses on distant subjects

① Slide bar

- Pressing and holding **◀/▶** will increase the focus speed.
- Focus can also be adjusted by dragging the slide bar.



② MF Assist (enlarged screen)



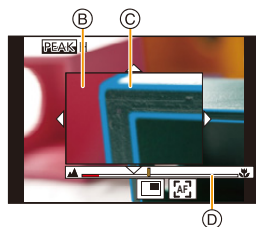

③ Peaking

④ MF Guide

- In-focus portions are highlighted with colour. (Peaking)
- You can check whether the point of focus is to the near side or to the far side. (MF Guide)



You can perform the following operations:

Button operation	Touch operation	Description of operation
▲/▼/◀/▶ *1	Dragging	Moves the enlarged area.
	Pinching out/in	Enlarges/reduces the screen in small steps.
	—	Enlarges/reduces the screen.
 *2	 *2	Switches the enlarged display (windowed/full screen). 
[DISP.] *1	[Reset] *1	First time: The position of the enlarged area is reset to the centre. Second time: The size is reset to the default.

*1 When using an interchangeable lens with no focus ring, you can perform these operations after pressing **▼** to display the screen that lets you set the area to be enlarged.

*2 Not available in Intelligent Auto Mode.

- When the picture is displayed in windowed mode, you can enlarge the picture by approximately 3× to 6×; when the picture is displayed in full screen, you can enlarge the picture by approximately 3× to 20×.

5 Press the shutter button halfway.

- You can also perform the same operation by pressing [MENU/SET].
- If you have enlarged the picture by rotating the focus ring or moving the focus lever, the assist screen will close approximately 10 seconds after the operation.

- MF Assist and MF Guide may not display depending on the lens used. To display MF Assist, use the touch screen or buttons to operate the camera directly.
- If [Focus Switching for Vert / Hor] in the [Custom] ([Focus / Release Shutter]) menu is enabled, you can store the position of the enlarged MF Assist display for each orientation of the camera.
- The focus distance reference mark (A) is a mark used to measure the focus distance.
Use this when taking pictures with MF or taking close-up pictures.

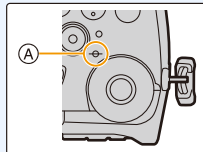

Achieving focus quickly using AF

Touching [].

- AF works at the centre of the frame.
- AF also works with the following operations.
 - Pressing the [AF/AE LOCK] to which [AF-ON] is assigned (P110)
 - Pressing the Fn button to which [AF-ON] is assigned (P60)
 - Dragging the monitor and releasing your finger at the position you want to focus on
- This function is not available when [4K Live Cropping] is set.

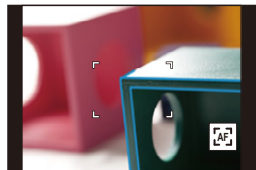

Locking Focus and Exposure (AF/AE Lock)

Applicable modes:          

Lock the focus and exposure in advance to take pictures with the same focus and exposure settings while changing the composition.

This is useful when you want to bring an edge of the screen into focus or there is a backlight, for example.

1 Point the camera at the subject.

2 Press and hold [AF/AE LOCK] to fix the focus or exposure.

- In default settings, [AE LOCK] will operate to fix the exposure. [AEL] will be displayed on the screen.
- If you release [AF/AE LOCK], AF/AE Lock is cancelled.

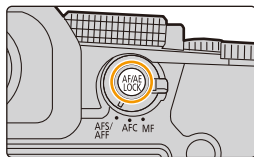

3 While pressing [AF/AE LOCK], move the camera as you compose the picture and then press shutter button fully.

■ Setting the functions of [AF/AE LOCK]

MENU →  [Custom] →  [Focus / Release Shutter] → [AF/AE Lock]

[AE LOCK]	The exposure is locked. • [AEL] is displayed.
[AF LOCK]	The focus is locked. • [AFL] is displayed.
[AF/AE LOCK]	Both focus and exposure are locked. • [AFL] and [AEL] are displayed.
[AF-ON]	AF is performed.

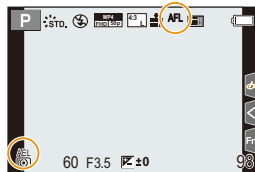

- AF Lock only is effective when taking pictures in Manual Exposure Mode.
- AE Lock only is effective when taking pictures with MF.
- The subject can be focused again by pressing the shutter button halfway even when AE is locked.
- Programme Shift can be set even when AE is locked.

Exposure Compensation

Applicable modes:  P A S M    

Use this function when you cannot achieve appropriate exposure due to the difference in brightness between the subject and the background.

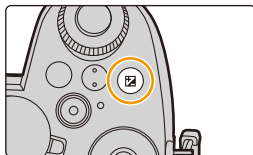

1 Press [].

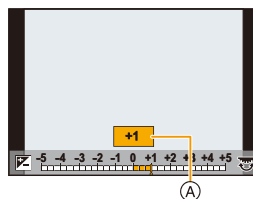

2 Rotate the front/rear dial or the control dial to compensate the exposure.

- Ⓐ Exposure Compensation
- In the [Custom] ([Operation]) menu, [Exposure Comp. Disp. Setting], you can change the functions to be set on the exposure compensation screen. (P46)



Underexposed	Properly exposed	Overexposed
	→ 	← 
Compensate the exposure towards positive.		Compensate the exposure towards negative.

3 Press [] to set.

- You can also press the shutter button halfway to set.

- In Manual Exposure Mode, you can compensate the exposure only when the ISO sensitivity is set to [AUTO].
- You can set the exposure compensation value in the range between -5 EV and $+5$ EV. You can set a value between -3 EV and $+3$ EV while recording motion picture or performing recording with the 4K Photo or Post Focus function.
- When [Auto Exposure Comp.] in [Flash] in the [Rec] menu is set to [ON], the brightness of the flash will automatically be set to the level appropriate to the selected Exposure Compensation.
- Depending on the brightness, this may not be possible in some cases.
- When the exposure compensation value falls below or exceeds the -3 EV to $+3$ EV range, the brightness of the recording screen will no longer change. Values outside this range will be applied to the recording screen when the shutter button is pressed halfway or AE Lock is performed with [AF/AE LOCK].
- The set Exposure Compensation value is stored even if the camera is turned off. (When [Exposure Comp. Reset] is set to [OFF])



MENU



Setting the ISO Sensitivity

Applicable modes:  P A S M 

This allows the sensitivity to light (ISO sensitivity) to be set.

1 Press [ISO].

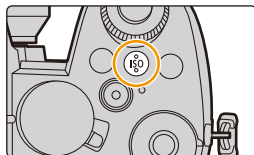

2 Rotate the front/rear dial or the control dial to select the ISO sensitivity.

- In the [Custom] ([Operation]) menu, [ISO Displayed Setting], you can change the functions to be set on the ISO sensitivity screen. (P45)

(A) ISO sensitivity



(A)

AUTO	The ISO sensitivity is automatically adjusted according to the brightness. • Maximum [ISO3200] ^{*1}
 (Intelligent ISO)	The camera automatically sets the optimum ISO sensitivity and shutter speed to suit the movement of the subject and brightness of the scene to minimise the jitter of the subject. • Maximum [ISO3200] ^{*1} • The shutter speed is not fixed when the shutter button is pressed halfway. It is continuously changing to match the movement of the subject until the shutter button is pressed fully.
L.100^{*2}, from 200 to 25600	The ISO sensitivity is fixed to various settings.

*1 When [ISO Auto Upper Limit Setting] in [ISO Sensitivity (photo)] in the [Rec] menu is set to [AUTO].

*2 When [Extended ISO] in the [Custom] ([Exposure]) menu is set to [ON].

3 Press [ISO] to set.

- You can also press the shutter button halfway to set.

**Characteristics of the ISO sensitivity**

	200 \longleftrightarrow 25600	
Recording location (recommended)	When it is light (outdoors)	When it is dark
Shutter speed	Slow	Fast
Noise	Less	Increased
Jitter of the subject	Increased	Less

- For details on the available flash range used when the ISO sensitivity is set to [AUTO], refer to P159.
- Cannot select [ISO] in the following cases:
 - Shutter-Priority AE Mode
 - Manual Exposure Mode
- When [Multi Exp.] is set, the maximum setting is [ISO3200].
- If you set [Photo Style] to [V-Log L], the lower limit of the ISO sensitivity will be fixed to [ISO400].
- When the following functions are being used, the ISO sensitivity that can be set is restricted:
 - Creative Video Mode/4K Photo recording/Post-Focus recording:
[AUTO], [200] to [6400] ([L.100] to [6400] if [Extended ISO] is set to [ON])
 - Live View Composite recording:
[200] to [1600] ([L.100] to [1600] if [Extended ISO] is set to [ON])
- You can set the ISO sensitivity in Scene Guide Mode only when using [Panorama Shot].

Extended ISO

Applicable modes: P A S M

You will be able to set ISO sensitivity down to a minimum of [ISO100].

MENU → [Custom] → [Exposure] → [Extended ISO] → [ON]

**Not available in these cases:**

- [Extended ISO] does not work in the following case:
 - When [Photo Style] is set to [V-Log L]
 - When using [Multi Exp.]

Setting the White Balance (WB)

Applicable modes:  P A S M 

White Balance adjusts the colour of white according to the light source to make the overall colour hue closer to what is seen by the eye.

1 Press [WB].

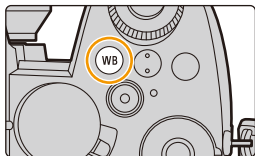





2 Rotate the front/rear dial or the control dial to select the White Balance.



[AWB]	Auto
[AWBc]	Auto (Reduces the reddish hue under an incandescent light source)
[AWBw]	Auto (Leaves the reddish hue under an incandescent light source)
[☀]	When taking pictures outdoors under a clear sky
[☁]	When taking pictures outdoors under a cloudy sky
[🏠]	When taking pictures outdoors in the shade
[💡]	When taking pictures under incandescent lights
[WB]	When taking pictures with the flash only

* [AWB] is applied when you record motion picture or perform recording with the 4K Photo or Post Focus function.

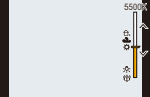
  	<p>A white object is recorded to set the White Balance. This is convenient for recording under multiple light sources.</p> <ol style="list-style-type: none"> Press ▲. Place a white object such as a piece of paper within the frame at the centre of the screen, and press [MENU/SET]. <ul style="list-style-type: none"> This will set the White Balance and return you to the recording screen. White Balance may not be set when the subject is too bright or too dark. Set the White Balance again after adjusting to appropriate brightness. 	
	<p>Set the White Balance Colour Temperature to suit the light source.</p> <ol style="list-style-type: none"> Press ▲. Press ▲/▼ to select the colour temperature and then press [MENU/SET]. <ul style="list-style-type: none"> You can set a colour temperature from [2500K] to [10000K]. 	

3 Press [WB] to set.

- You can also press the shutter button halfway to set.



Under fluorescent lighting, LED lighting fixture etc., the appropriate White Balance will vary depending on the lighting type.

Use [AWB], [AWBc], [AWBw], [A], [B], [C] or [D].

- If you take pictures with the flash outside the available flash range, the correct White Balance may not be obtained.
- During Scene Guide Mode:
 - Settings are adjusted to suit each scene.
 - Changing the scene or Recording Mode will return White Balance settings (including the White Balance fine-adjustment setting) to [AWB].

■ Auto White Balance

Depending on the conditions prevailing when pictures are taken, the pictures may take on a reddish or bluish tinge.

Please note that the White Balance may not work correctly in the cases below. In these cases, adjust the White Balance to anything other than [AWB], [AWBc] or [AWBw].

- When there are multiple light sources
- When there are no colours close to white

1 [AWB] will work within this range.

- 2 Blue sky
- 3 Cloudy sky (Rain)
- 4 Shade
- 5 Sunlight
- 6 White fluorescent light
- 7 Incandescent light bulb
- 8 Sunrise and sunset
- 9 Candlelight

K=Kelvin Colour Temperature

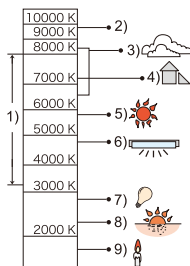

Finely adjusting the White Balance

You can adjust the colouring even when the colouring you want to apply is not produced by the selected white balance.

1 **Select the White Balance and then press ▼.**

2 **Press ▲/▼/◀/▶ to adjust the colouring.**

- ◀ : [A] (AMBER: ORANGE)
- ▶ : [B] (BLUE: BLUISH)
- ▲ : [G] (GREEN: GREENISH)
- ▼ : [M] (MAGENTA: REDDISH)

- You can also make fine adjustments by touching the White Balance graph.

- To reset the position to the centre, press [DISP.].

- You can set the White Balance Bracket by rotating the control dial. (P147)

3 **Press [MENU/SET].**

- Press the shutter button halfway to return to the recording screen.

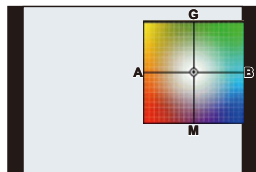

- If you adjust the White Balance to [A] (amber), the White Balance icon on the screen will change to orange.
- If you adjust the White Balance to [B] (blue), the White Balance icon on the screen will change to blue.
- If you adjust the White Balance to [G] (green) or [M] (magenta), [+] or [-] appears beside the White Balance icon on the screen.

5.

4K Photo and Drive Settings



Select a Drive Mode



Applicable modes:

You can change what the camera will do when you press the shutter button.

MENU

Rotating the drive mode dial.

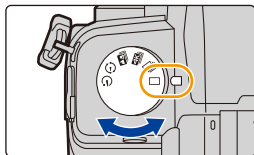

	Single	When the shutter button is pressed, only one picture is recorded.
	Burst (P119)	Recordings are made in succession while the shutter button is pressed.
	4K PHOTO (P122)	When the shutter button is pressed, a 4K photo is recorded.
	Post Focus (P133)	When the shutter button is pressed, Post Focus recording is performed.
	Time Lapse Shot/Stop Motion Animation (P138, 140)	Pictures are recorded with Time Lapse Shot or Stop Motion Animation.
	Self Timer (P143)	When the shutter button is pressed, recording takes place after the set time has elapsed.

Taking Pictures using Burst Mode

Applicable modes:

Pictures are taken continuously while the shutter button is pressed.

1 Set the drive mode dial to [].

2 Select the Burst Mode setting.

MENU → [Rec] → [Burst Rate]

Settings: [H] (High speed), [M] (Middle speed), [L] (Low speed)

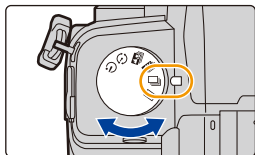

3 Focus on the subject and take a picture.

- Hold down the shutter button fully to activate the Burst Mode.



■ Burst Rate

	Burst Rate	Live View during Burst Mode
[H] (High speed)	9 frames/second ([AFS]/[MF]) 6 frames/second ([AFF]/[AFC])	None ([AFS]/[MF]) Available ([AFF]/[AFC])
[M] (Middle speed)	6 frames/second	Available
[L] (Low speed)	2 frames/second	Available

■ Number of burst picture frames

	With RAW files	Without RAW files
[H] (High speed)	30 frames or more	600 frames or more
[M] (Middle speed)		
[L] (Low speed)		

- When recording is performed under the test conditions specified by Panasonic. The burst speed will become slower halfway. However, pictures can be taken until the capacity of the card becomes full. Depending on recording conditions, the number of burst pictures that can be taken will be reduced.

■ About the maximum number of pictures that can be taken continuously

When you press the shutter button halfway, the maximum number of pictures you can take continuously will appear.

You can check the approximate number of burst pictures that can be taken at a constant recording speed.

Example: When 20 pictures can be taken: [r20]

- Once recording starts, the maximum number of pictures that can be taken continuously will decrease.

The recording speed slows down when [r0] appears.

- When [r99+] is displayed, you can take 100 or more pictures continuously.



■ Notes on focus in Burst Mode

The way focus is achieved varies according to the focus mode setting and the [Focus/Release Priority] setting in the [Custom] ([Focus / Release Shutter]) menu.

Focus mode	[Focus/Release Priority]	[H]	[M]/[L]
[AFS]	[FOCUS]	At the first picture	
	[BALANCE]		
	[RELEASE]		
[AFF]/[AFC] ^{*1}	[FOCUS]	Predicted focusing ^{*2}	Normal focusing ^{*3}
	[BALANCE]	Predicted focusing ^{*2}	
	[RELEASE]		
[MF]	—	Focus set with MF	

*1 When the subject is dark, the focus is fixed on the first picture.

*2 Burst speed takes priority, and focus is estimated within possible range.

*3 The burst speed may become slower.

- The burst speed may become slower depending on the following settings.
 - [Picture Size]/[Quality]/[Sensitivity]/Focus Mode/[Focus/Release Priority]
- When the burst rate is set to [H] (when the focus setting is [AFS] or [MF]), the exposure will be set to that of the first picture. In other cases, the exposure will be adjusted for each picture.
- **It may take time to save pictures taken in Burst Mode on the card. If you take pictures continuously while saving, the maximum number of recordable pictures decreases. For continuous shooting, use of a high speed memory card is recommended.**
- We recommend using the shutter remote control (DMW-RS2: optional) when you want to keep the shutter button pressed fully while taking pictures in Burst Mode.

 **Not available in these cases:**

- Burst recording does not work in the following cases:
 - [Glistening Water]/[Glittering Illuminations]/[Handheld Night Shot]/[Soft Image of a Flower]/[Panorama Shot] (Scene Guide Mode)
 - [Rough Monochrome]/[Silky Monochrome]/[Miniature Effect]/[Soft Focus]/[Star Filter]/[Sunshine] (Creative Control Mode)
 - When recording using the flash
 - When using [Multi Exp.]

4K Photo Recording

Applicable modes:   **P** **A** **S** **M**   

The camera allows you to take burst pictures of 8 million pixels (approx.) at 30 frames/second. After taking these pictures, you can save the desired moment extracted from their burst file.

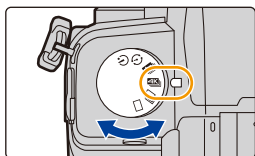

- Use a UHS Speed Class 3 card.

1 Set the drive mode dial to .



2 Select the recording method.

MENU →  **[Rec]** → **[4K PHOTO]** → **[Rec Method]**

 [4K Burst]	For capturing the best shot of a fast-moving subject (e.g., sports, aeroplanes, trains) Audio recording: Not available
 [4K Burst(S/S)] "S/S" is an abbreviation of Start/Stop.	For capturing unpredictable photo opportunities (e.g., plants, animals, children) Audio recording: Available*
 [4K Pre-Burst]	For recording as needed whenever a photo opportunity arises (e.g., the moment when a ball is thrown) Audio recording: Not available

* Audio is not played back when you perform playback with the camera.

3 Press the shutter button halfway to exit the menu.

4 Record a 4K photo.

- If you are using AF, [Continuous AF] will work during recording. Focus will be adjusted continuously.



MENU





[4K Burst]

- 1 Press the shutter button halfway.
- 2 Press and hold the shutter button fully for as long as you want to perform recording.

- (A) Press and hold
(B) Recording is performed

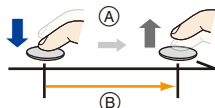
- Press the button fully slightly in advance. Recording starts approximately 0.5 seconds after it has been pressed fully.
- If you remove your finger from the shutter button immediately after the start of recording, up to a period of approximately 1.5 seconds after the moment that the finger has been removed may be recorded.





[4K Burst(S/S)]

- 1 Press the shutter button fully to start recording.
- 2 Press the shutter button fully again to stop recording.

- (C) Start (First)
(D) Stop (Second)
(E) Recording is performed

 **Setting markers manually**

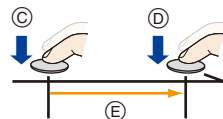
You can add markers if you press [Fn2] during recording. (Up to 40 markers per recording) When selecting and saving pictures from a 4K burst file, you can skip to the positions where you added markers.



[4K Pre-Burst]

Press the shutter button fully.

- (F) Approximately 1 second
(G) Recording is performed
- AF adjusts focus continuously, and except in Manual Exposure Mode, it also adjusts exposure continuously.

- Images may not be displayed as smoothly as when recording with the normal recording screen.

 **Recording tips**

In situations where you want to lock focus and exposure, such as when the subject is not at the centre, use [AF/AE LOCK]. (P110)

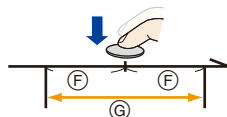

- The camera will perform burst recording of a 4K photo and saves it as a 4K burst file with a [Rec Format] setting of [MP4].
- When [Auto Review] is enabled, the picture selection screen will be displayed automatically. To continue recording, press the shutter button halfway to display the recording screen.
- For information on how to select and save pictures from recorded 4K burst files, refer to P128.

■ Setting Pre-Burst Recording ([4K Burst]/[4K Burst(S/S)])

The camera starts recording approximately 1 second before the shutter button is pressed fully, so you will not miss a photo opportunity.

MENU →  **[Rec]** → **[4K PHOTO]** → **[Pre-Burst Recording]**

Settings: [ON]/[OFF]

- When this function is enabled, **[PRE]** is displayed on the recording screen.
- When **[Pre-Burst Recording]** is being used, AF operations and unavailable menus are the same as those during **[4K Pre-Burst]** operation.

■ Setting Loop Recording ([4K Burst(S/S)])

You can perform recording while deleting the oldest recorded data, allowing you to keep on recording while waiting for a photo opportunity without replacing the card.

- Once you start recording, the 4K burst file will be recorded and divided approximately every 2 minutes.

Approximately the last 10 minutes (up to approximately 12 minutes) will be saved.

The preceding part will be deleted.

MENU →  **[Rec]** → **[4K PHOTO]** → **[Loop Recording(4K PHOTO)]**

Settings: [ON]/[OFF]

- **We recommend that you use a sufficiently charged battery or an AC adaptor (optional) and the DC coupler (optional).**
- Up to 12 hours of continuous recording is possible.
- When this function is enabled, **[↻]** is displayed on the recording screen.



Not available in these cases:

- **[Loop Recording(4K PHOTO)]** is not possible when there is insufficient free space on the card.



Battery drainage and camera temperature

- If the ambient temperature is high or 4K photo recording is performed continuously, **[⚠]** may be displayed and then recording may stop. Wait until the camera cools down.
- **When **[] ([4K Pre-Burst])^{*} or **[Pre-Burst Recording]** is set, the battery drains faster and the camera temperature rises. Use these functions only when recording with them.****

* The setting may switch to **[] ([4K Burst])** to protect the camera.

Notes on the 4K Photo function

■ To change the aspect ratio

Selecting [Aspect Ratio] in the [Rec] menu allows you to change the aspect ratio for 4K photos.

■ To record the subject with reduced blur

You can reduce the blur of the subject by setting a faster shutter speed.

1 Set the mode dial to [S].

2 Set the shutter speed by rotating the rear dial or the front dial.

- Approximate shutter speed for outdoor recording in fine weather conditions: 1/1000 seconds or faster.
- If you increase the shutter speed, the ISO sensitivity becomes higher, which may increase the noise on the screen.

■ Preventing camera shake when you are recording pictures

- To reduce camera shake, we recommend that you use a tripod and shutter remote control (DMW-RS2: optional) when using [Light Composition] or [Sequence Composition].

■ Shutter sound for recording

- When using [4K Burst] or [4K Pre-Burst], you can change the electronic shutter sound settings in [E-Shutter Vol] and [E-Shutter Tone].
- When recording with [4K Burst(S/S)], you can set the start/stop tone volume in [Beep Volume].
- High-speed burst recording can be used quietly when used in combination with [Silent Mode].

■ Scenes not suitable

Recording in extremely bright locations or indoors

When subjects are recorded in an extremely bright place or under fluorescent/LED lighting, the colour tone or brightness of the image may change, or horizontal stripes may appear on the screen.

Lowering the shutter speed may reduce the effect of the horizontal stripes.

Subjects that are moving fast in the horizontal direction

If you record a subject moving fast in the horizontal direction, the subject in the recorded pictures may appear distorted.

■ The camera's setup for the 4K Photo function

The camera's setup is automatically optimised for 4K photo recording.



- The following [Rec] menu items are fixed to the settings below:

[Picture Size]	[4K] (8M)	[Quality]	[
	[4:3]: 3328×2496 [3:2]: 3504×2336 [16:9]: 3840×2160 [1:1]: 2880×2880	[Shutter Type]	[ESHTR]

- 4K burst files are recorded with the settings indicated below:

Settings in the [Motion Picture] menu are not applied to 4K burst files.

[Rec Format]	[MP4]	[Continuous AF]	[ON]
[Rec Quality]	[4K/100M/30p]	[Luminance Level]	[0–255]

- When recording with the 4K Photo function, the ranges for the following functions differ from the ones available for taking pictures:
 - Shutter speed: 1/30 to 1/16000
 - [Min. Shtr Speed]: [1/1000] to [1/30]
 - Exposure Compensation: –3 EV to +3 EV
 - ISO sensitivity: [AUTO], [200] to [6400] ([L.100] to [6400] when [Extended ISO] is set to [ON])
- When recording with the 4K Photo function, the following functions are disabled:
 - Flash
 - Bracket Recording
 - Programme Shift
 - Focus mode (AFF)
 - AF Mode ()
 - [MF Assist] ([4K Pre-Burst] only)
 - White Balance ()
- The following menu items are disabled:

[Intelligent Auto]	[iHandheld Night Shot]/[iHDR]
[Creative Control]	[Simultaneous Record w/o Filter]
[Rec]	[Picture Size]/[Quality]/[AFS/AFF]/[AF Sensitivity(Photo)]/ [Color Space]/[Flash]/[Long Shtr NR]/[Shading Comp.]/[Ex. Tele Conv.] ([Rec])/[Live View Composite]/[Shutter Type]/[Shutter Delay]/[Bracket]/ [HDR]
[Custom]	[Rec Area]/[Face Recog.]/[Profile Setup]
[Setup]	[Economy] (when [4K Pre-Burst] is set)

- 4K burst file will be recorded and played back in separate files in the following cases. (You can continue recording without interruption.)
 - **When using an SDHC memory card:**
If the file size exceeds 4 GB
 - **When using an SDXC memory card:**
If the continuous recording time exceeds 3 hours and 4 minutes or if the file size exceeds 96 GB
- The following changes occur when recording 4K photos:
 - The angle of view becomes narrower.
 - [Location] in [Travel Date] cannot be recorded.
 - [Simultaneous Record w/o Filter] in [Filter Settings] is not available.
 - It is not possible to use the HDMI output.
- When recording with [4K Pre-Burst], [Step Zoom] in [Power Zoom Lens] is disabled.
- Scene Detection in Intelligent Auto Mode works the same way as when recording motion pictures.
- When the drive mode is set to 4K Photo, it is not possible to take pictures while recording motion picture. (Only when [📷] (Photo Priority) is set)
- To select and save pictures from 4K burst files on a PC, use the software “PHOTOfunSTUDIO”. Please note that it is not possible to edit a 4K burst file as a motion picture.

 **Not available in these cases:**

- 4K Photo does not work in the following cases:
 - [Clear in Backlight]/[Glistening Water]/[Artistic Nightscape]/[Glittering Illuminations]/[Handheld Night Shot]/[Clear Night Portrait]/[Soft Image of a Flower]/[Panorama Shot] (Scene Guide Mode)
 - [Rough Monochrome]/[Silky Monochrome]/[Miniature Effect]/[Soft Focus]/[Star Filter]/[Sunshine] (Creative Control Mode)
 - When recording motion pictures
 - When using [Multi Exp.]

Selecting pictures from 4K burst file



1 Select an image with the icon on the playback screen, and press **▲**.



- You can also perform the same operation by touching the icon .
- If the image was recorded with [4K Pre-Burst], proceed to step 3.



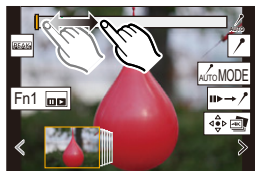

2 Drag the slide bar to make a rough selection of scenes.

Slide view screen

- For information on how to use the slide view screen, refer to P129.
- You can select its scenes on the 4K burst playback screen by touching  (Fn1). (P130)
- Touching  allows you to switch to the marker operation screen. (P131)



3 Drag the frames to select the frame you want to save as a picture.

- You can also perform the same operation by pressing .
- To continuously rewind/forward frame-by-frame, touch and hold [ |  | ].

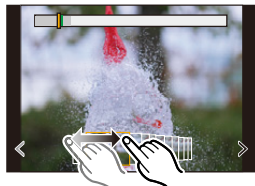

4 Touch to save the picture.

- The picture will be saved in JPEG format.

- The picture will be saved with recording information (Exif information), including its shutter speed, aperture and ISO sensitivity information.
- 4K burst files saved on a PC will be treated as MP4 motion pictures.

■ [4K PHOTO Bulk Saving]

You can save any 5-second period of pictures from a 4K burst file all at once.

1 Select the menu.

MENU →  **[Playback]** → **[4K PHOTO Bulk Saving]**

2 Press to select the 4K photo burst files and press **[MENU/SET]**.

- If the burst time is 5 seconds or less, all frames will be saved as pictures.

3 Select the first frame of the pictures to be saved at once.

- Select the frame in the same way as you select pictures from a 4K burst file.
- Pictures will be saved as a group of Burst Mode pictures in JPEG format. (P189)

Operations during selecting pictures

■ Navigating the slide view screen

Position of the displayed frame

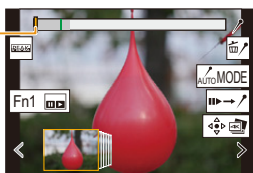

Button operation	Touch operation	Description of operation
	Dragging/ < / >	Selects a frame. • To change the frames displayed in slide view, select the frame at the left/right end, and touch [<] or [>].
	Press and hold < / >	Continuously rewinds/forwards frame-by-frame.
—	 Touching/ Dragging	Selects the frame to be displayed. • The previous or next frame is displayed in slide view.
	Pinching out/in	Enlarges/reduces the display.
	—	Selects a frame while maintaining the enlarged display. (during enlarged display)
	Dragging	Moves the enlarged area (during enlarged display).
—		Switches a marker to be displayed. (P132)
Fn1		Displays the 4K burst playback screen.
—		Switches to marker operation. (P131)
—		Adds/deletes a marker.
—		In-focus portions are highlighted with colour. ([Peaking]) • Switches in order of [PEAK OFF] → [PEAK L] ([LOW]) → [PEAK H] ([HIGH]).
[MENU/SET]		Saves the picture

■ Navigating the 4K burst playback screen

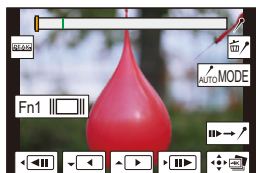

During pause



During continuous playback

Button operation	Touch operation	Description of operation
▲	▶/	Continuous playback/Pause (during continuous playback).
▼	◀/	Continuous rewind/Pause (during continuous rewind).
▶/⊙	▶▶/ ▶▶	Fast forward/Frame-by-frame forward (during pause).
◀/⊙	◀◀/ ◀◀	Fast rewind/Frame-by-frame rewind (during pause).
—	Touching/ Dragging	Selects the frames to be displayed (during pause).
	Pinching out/in	Enlarges/reduces the display (during pause).
	—	Selects a frame while maintaining the enlarged display (during enlarged display).
▲/▼/◀/▶	Dragging	Moves the enlarged area (during enlarged display).
—	AUTO MODE	Switches a marker to be displayed. (P132)
Fn1	□	Displays the slide view screen (during pause).
—	▶▶→/↗	Switches to marker operation. (P131)
—	↗ / ↖	Adds/deletes a marker.
—	PEAK	In-focus portions are highlighted with colour. ([Peaking]) • Switches in order of [PEAK OFF] → [PEAK L] ([LOW]) → [PEAK H] ([HIGH]).
[MENU/SET]	⊙	Saves the picture (during pause).

- Each time you touch the screen twice, the display switches between enlarged and normal view.

Selecting and saving pictures on the TV screen

- Set [HDMI Mode (Play)] to either [AUTO] or a setting with a resolution of [4K/25p].
When connecting to a TV that does not support 4K motion picture, select [AUTO].
- If you display 4K burst files on a TV connected to the camera, they will be displayed on the 4K burst playback screen.
- Depending on the TV to be connected, 4K burst files may not be played back correctly.

Marker

When selecting and saving pictures from a 4K burst file, you can select pictures easily by skipping between marked positions.

Two types of markers are available.

White marker:

This is manually set during recording or playback.

Green marker:

This is automatically set by the camera during recording. (Auto Marking function)

Marker operation screen



■ Skips to the marked positions

When [Fn1] is touched on the slide view screen or 4K burst playback screen, the marker operation screen appears and you can skip to the marked positions. Touch [Fn1] to return to the original operation.

Button operation	Touch operation	Description of operation
◀▶	◀ / ▶	Moves to the previous/next marker.



Auto Marking function

The camera automatically sets markers on scenes in which a face or the movement of a subject is detected.

(Example: At the scene when a vehicle passes by, a balloon bursts, or a person turns around)

- Up to 10 markers are displayed for each file.
- In the following cases, markers may not be set by the Auto Marking function depending on the recording conditions and the status of subjects.
 - The camera is moving because of panning or jitter
 - The movement of a subject is slow/small
 - The subject is small
 - A face is not facing front

■ Switches a marker to be displayed

Touch [] on the slide view screen, 4K burst playback screen, or marker operation screen.

[Auto]	Displays a marker on a scene in which a face or the movement of a subject is detected.
[Face Priority]	Displays a marker with preference given to a scene in which a face is detected.
[Motion Priority]	Displays a marker with preference given to a scene in which the movement of a subject is detected.
[Off]	Displays manually set markers only.

- You cannot delete markers set by the Auto Marking function.
- The markers set by the Auto Marking function may not be displayed correctly if you split the 4K burst file on another device and then play it back on the camera.
- In the following case, markers set by the Auto Marking function are not displayed.
 - 4K burst files recorded with [4K Pre-Burst]

Post Focus Recording

Applicable modes:   P A S M   

The camera allows you to take 4K burst pictures while shifting the focus to different areas. After taking these pictures, you can select the desired focus area.

This function is suited for recording still objects.



4K burst recording while automatically shifting the focus.

Touch the desired focus point.

A picture with the desired focus point is made.

- Use a UHS Speed Class 3 card.
- We recommend that you use a tripod when recording images to be used for Focus Stacking.

1 Set the drive mode dial to .

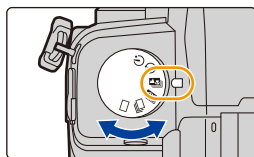

2 Decide on the composition, and press the shutter button halfway.

- AF will detect focus areas on the screen. (Excluding the edges of the screen)
- While the shutter button is pressed and held halfway, shake may be seen on the screen.
- If no areas on the screen can be brought into focus, the focus display (A) will flash. Recording is not possible in this case.



From the time you press the shutter button halfway until the end of recording:

- Maintain the same distance to the subject and the same composition.

3 Press the shutter button fully to start recording.



- The focus point changes automatically while recording. When the icon (E) disappears, recording automatically ends.
- A motion picture will be recorded with [Rec Format] set to [MP4]. (Audio will not be recorded.)
- When [Auto Review] is enabled, a screen that lets you select the desired focus area will be displayed. (P135)



About camera temperature

- When the ambient temperature is high or Post Focus recording is performed continuously, the camera may display [⚠] and recording may stop. Wait until the camera cools down.

■ Limitations on the Post Focus function

- Since recording is performed in the same image quality as 4K photos, certain limitations apply to recording functions and menu settings. For details, refer to “The camera's setup for the 4K Photo function” on P126.
- In addition to the limitations of the 4K Photo function, the following limitations apply to the Post Focus function:
 - AF Mode is disabled.
 - MF operation is disabled.
 - Motion pictures cannot be recorded.
 - [Digital Zoom] is disabled.
 - The following [Custom] menu items are disabled: [Shutter AF]



Not available in these cases:

- Post Focus recording does not work in the following cases:
 - [Clear in Backlight]/[Glistening Water]/[Artistic Nightscape]/[Glittering Illuminations]/[Handheld Night Shot]/[Clear Night Portrait]/[Soft Image of a Flower]/[Panorama Shot] (Scene Guide Mode)
 - [Rough Monochrome]/[Silky Monochrome]/[Miniature Effect]/[Soft Focus]/[Star Filter]/[Sunshine] (Creative Control Mode)
 - When [Multi Exp.] is set

Selecting the Focus Position for the Picture to Save

- 1 **Select an image with the [] icon on the playback screen, and press ▲.**











- You can also perform the same operation by touching the icon [].



- 2 **Touch the desired focus area.**

- If a picture that is in focus is not available for the selected area, a red frame will be displayed. You cannot save a picture in this case.
- You cannot select the edges of the screen.



Button operation	Touch operation	Description of operation
	Touching	Selects a focus area. • It cannot be selected during enlarged display.
		Enlarges the display.
		Reduces the display (during enlarged display).
Fn1		Switches to the Focus Stacking function. (P136)
—		In-focus portions are highlighted with colour. ([Peaking]) • Switches in order of [ OFF] → [ L] ([LOW]) → [ H] ([HIGH]).
[MENU/SET]		Saves the picture.

- You can fine-adjust the focus by dragging the slide bar during enlarged display. (You can also perform the same operation by pressing ◀/▶.)

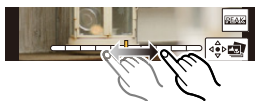

- 3 **Touch [] to save the picture.**

- The picture will be saved in JPEG format.

- You cannot display an image on a TV screen and then select the focus position.

Focus Stacking

Save a picture with multiple focus positions merged.

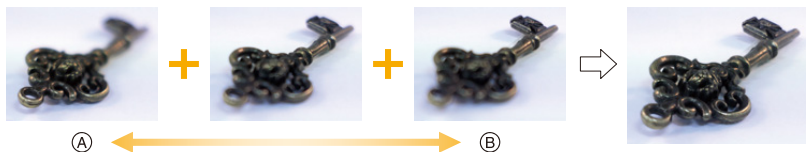

(A) Focus: closer

(B) Focus: farther away

1 Touch **[MENU]** on the screen that lets you select the desired focus area in step 2 of “Selecting the Focus Position for the Picture to Save” (P135).

• You can also perform the same operation by pressing the Fn button (Fn1).

2 Touch the merging method.

[Auto Merging]	Automatically selects pictures that are suited to be merged, and merges them into a single picture. <ul style="list-style-type: none"> • Priority will be given to pictures with closer focus. • Perform the focus stacking and save the picture.
[Range Merging]	Merges pictures with specified focus areas into a single picture.

(When **[Range Merging]** is selected)

3 Touch the desired focus area.

- Specify at least two areas.
- In-focus areas between the selected two points are indicated.
- Parts that cannot be selected are indicated in grey.
- To cancel the selection, touch the focus area again.
- To select multiple areas, drag the screen.

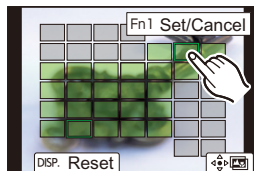
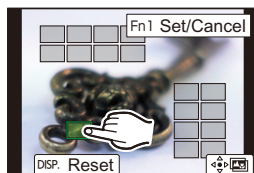

Button operation	Touch operation	Description of operation
	Touching	Selects an area.
Fn1	[Set/Cancel]	Specifies/cancels an area.
[DISP.]	[All]	Selects all areas. (Before selecting areas)
	[Reset]	Cancels all selections. (After selecting areas)
[MENU/SET]		Merges pictures and saves the resulting picture.

4 Touch [] to merge the pictures and save the resulting picture.

- The picture will be saved in JPEG format. Recording information (Exif information) of the original picture with the closest focus distance, including the shutter speed, aperture, and ISO sensitivity, will also be recorded to the new picture.

- The camera may automatically correct the misalignments of pictures caused by camera shake. If they are corrected, the angle of view becomes slightly narrower when pictures are merged.
- Pictures may be merged into an unnatural picture in the following cases:
 - When the subject moves during recording
 - When the distance between subjects is great
 - When pictures are too defocused (If you take pictures with a larger aperture value, the resulting picture may look less unnatural.)
- You may not be able to use Focus Stacking for images recorded with other devices.



MENU



Taking Pictures with Time Lapse Shot/ Stop Motion Animation

Applicable modes: **T** **A** **P** **A** **S** **M** **SCN**

You can take pictures with Time Lapse Shot or Stop Motion Animation. In addition, the pictures taken can be combined into a motion picture.

• Set the date and time settings in advance. (P39)

• Recorded pictures are displayed as group pictures.



[Time Lapse Shot]

The camera can automatically take pictures of subjects such as animals or plants as time elapses and create a motion picture.

- 1 Set the drive mode dial to [].
- 2 Select the menu.

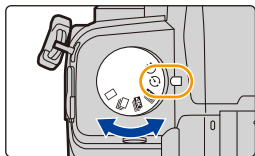
MENU →  **[Rec]** → **[Time Lapse/Animation]** → **[Mode]** → **[Time Lapse Shot]**



- You can also perform the same operation by touching .
- After switching the drive mode dial to [], pressing [MENU/SET] will display the menu with [Time Lapse/Animation] selected. (It displays in this state only once after switching the drive mode dial.)

- 3 Press **▲/▼** to select an item and set.

[Shooting Interval Setting]	[ON]	Sets the time from recording start time to the next recording start time.
	[OFF]	After recording is finished, the next recording is started without any interval.
[Start Time]	[Now]	Starts the recording by fully-pressing the shutter button.
	[Start Time Set]	Any time up to 23 hours 59 minutes ahead can be set. ◀/▶: Select the item (hour/minute) ▲/▼: Setting [MENU/SET]: Set
[Image Count]/ [Shooting Interval]^{*1}		The number of pictures and the recording interval can be set. ◀/▶: Select the item (minute/second/number of pictures) ▲/▼: Setting [MENU/SET]: Set

*1 Can be set only when [Shooting Interval Setting] is set to [ON].

- The estimated recording ending time is displayed on the setting screen. It is displayed under the following conditions when [Shooting Interval Setting] is set to [OFF]:
 - Recording Mode: Shutter-Priority AE Mode or Manual Exposure Mode
 - Focus Mode: [MF]
- The camera may not be able to record using the pre-set interval and number of pictures to be recorded or may not finish recording at the estimated recording ending time under some recording conditions.



4 Press the shutter button halfway.

- The recording screen will be displayed.



5 Press the shutter button halfway to focus and then press it fully to take the picture.

- The recording starts automatically.
- During recording standby, the camera will turn off automatically if no operation is performed for a certain period. The Time Lapse Shot is continued even with the camera turned off. When the recording start time arrives, the camera turns on automatically. To turn on the camera manually, press the shutter button halfway.
- Operations during recording standby (The camera is turned on)

Button operation	Touch operation	Description of operation
[Fn2]*2	 *3	Displays a selection screen that lets you pause or stop the recording.
		Displays a selection screen that lets you resume or stop the recording (during pause).

- *2 When you record pictures by setting [Shooting Interval Setting] to [OFF], you can press [Fn2] even while recording is in progress. After recording (exposure) of a picture taken at the time when you pressed [Fn2] is finished, a selection screen is displayed.
- *3 When you record pictures by setting [Shooting Interval Setting] to [OFF], you cannot perform touch operation.
- After the recording stops, a confirmation screen will be displayed, asking whether to proceed to create a motion picture. To create a motion picture, select [Yes]. For information on creating motion pictures, refer to "Motion pictures using Time Lapse Shot/Stop Motion Animation". (P142)

- This function is not for use in a security camera.
- [Time Lapse Shot] is paused in the following cases.
 - When the charge on the battery runs out
 - Turning the camera off

During [Time Lapse Shot], you can replace the battery and the card, and then restart by turning on this unit. (Note that the pictures taken after replacing the card will be saved as a separate set of group pictures.)

Set the camera on/off switch to [OFF] when replacing the battery or card.

- When [Shooting Interval] is set to a longer value, if the camera turns off automatically while waiting for the next recording, we recommend that you use Time Lapse Shot in AF Mode.



Not available in these cases:

- This function is not available in the following cases:
 - [Handheld Night Shot]/[Panorama Shot] (Scene Guide Mode)
 - When using [Multi Exp.]

Recording with Stop Motion Animation

A stop motion picture is created by splicing pictures together.

- 1 Set the drive mode dial to [].
- 2 Select the menu.

MENU → [Rec] → [Time Lapse/Animation] → [Mode] → [Stop Motion Animation]

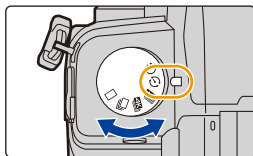

- You can also perform the same operation by touching .
- After switching the drive mode dial to [], pressing [MENU/SET] will display the menu with [Time Lapse/Animation] selected. (It displays in this state only once after switching the drive mode dial.)

- 3 Press **▲/▼** to select an item and set.

[Auto Shooting]	[ON]	Takes pictures automatically at a set recording interval.
	[OFF]	This is for taking pictures manually, frame by frame.
[Shooting Interval]	(Only when [Auto Shooting] is set to [ON])	
	◀/▶	Select the item (second)
	▲/▼	Setting
	[MENU/SET]	Set

- 4 Press the shutter button halfway.
 - The recording screen will be displayed.



- 5 Press the shutter button halfway to focus and then press it fully to take the picture.
- 6 (When taking the second and subsequent pictures) Move the subject to decide on the composition and then take the picture. (Repeat this)



- Up to 9999 frames can be recorded.
- If this unit is turned off while recording, a message for resuming the recording is displayed when the camera is turned on. Selecting [Yes] allows you to continue the recording from the interruption point.

Recording materials skillfully

- The recording screen displays up to two pictures taken previously. Use them as reference for the amount of movement.
- To check the recorded pictures, press [▶].
Unnecessary pictures can be deleted by pressing [🗑️].
To return to the recording screen, press [▶] again.

7 Touch [] to end the recording.

- It can also be ended by selecting [Time Lapse/Animation] from the [Rec] menu and then pressing [MENU/SET].
- When [Auto Shooting] is set to [ON], select [End] on the confirmation screen.
(If [Pause] has been selected, press the shutter button fully to resume the recording.)

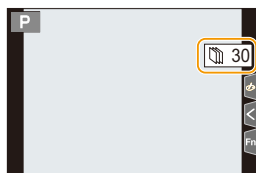

- After the recording stops, a confirmation screen will be displayed, asking whether to proceed to create a motion picture.
To create a motion picture, select [Yes].

For information on creating motion pictures, refer to "Motion pictures using Time Lapse Shot/Stop Motion Animation". (P142)

■ Adding pictures to the Stop Motion Animation group

Selecting [Add to Picture Group] in step 3 will display group pictures recorded with [Stop Motion Animation].

Select a set of group pictures, and then press [MENU/SET].

- Recording takes time under certain recording conditions, such as when the flash is used for recording. Automatic recording, as a result, may not take place at set intervals.
- A picture cannot be selected from [Add to Picture Group] when it is the only one that was taken.

Not available in these cases:

- This function is not available in the following cases:
 - [Panorama Shot] (Scene Guide Mode)
 - When using [Multi Exp.]
- [Auto Shooting] in [Stop Motion Animation] is not available for the following functions:
 - [Handheld Night Shot] (Scene Guide Mode)

Motion pictures using Time Lapse Shot/Stop Motion Animation

After performing Time Lapse Shot or stop motion recording, you can proceed to create a motion picture.

1 Select the methods for creating a motion picture.

- The recording format is set to [MP4].

[Rec Quality]	Sets the quality of a motion picture.
[Frame Rate]	Sets the number of frames per second. The larger the number is, the smoother the motion picture will be.
[Sequence]	[NORMAL]: Splices pictures together in recording order. [REVERSE]: Splices pictures together in reverse recording order.

2 Press ▲/▼ to select [OK] and then press [MENU/SET].

- You can also create motion pictures using [Time Lapse Video] (P254) or [Stop Motion Video] (P254) in the [Playback] menu.
- When creating motion pictures with a [Rec Quality] setting of [4K], recording times are limited to 29 minutes and 59 seconds.
 - When using an SDHC Memory Card, you cannot create motion pictures with a file size exceeding 4 GB.
 - When using an SDXC Memory Card, you can create motion pictures with a file size exceeding 4 GB.
- A motion picture with a [Rec Quality] setting of [FHD] or [HD] cannot be created if the recording time exceeds 29 minutes and 59 seconds or the file size exceeds 4 GB.

Recording Using the Self-timer

Applicable modes:   P A S M   

1 Set the drive mode dial to [⏻].

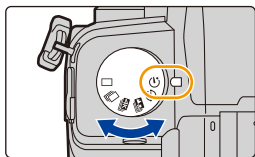

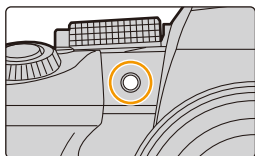

2 Press the shutter button halfway to focus and then press it fully to take the picture.

- The focus and exposure are fixed when the shutter button is pressed halfway.
- After the self-timer indicator flashes, recording starts.



■ Setting the self-timer

MENU →  [Rec] → [Self Timer]

	Picture is taken 10 seconds after shutter is pressed.
	After 10 seconds the camera takes 3 pictures at about 2 seconds intervals.
	Picture is taken 2 seconds after shutter is pressed. • This setting is a convenient way to avoid camera blur caused by pressing the shutter button.

- We recommend using a tripod when recording with the self-timer.

Not available in these cases:

-  is not available in the following cases.
 - When [Simultaneous Record w/o Filter] of [Filter Settings] is set to [ON]
 - When recording with the Bracket function
 - When using [Multi Exp.]
 - When recording with Live View Composite
- The self-timer does not work in the following case:
 - When recording motion pictures

Bracket Recording

Applicable modes: **P** **A** **S** **M**

You can take multiple pictures while automatically adjusting a setting by pressing the shutter button.

1 Select the menu.

MENU → [Rec] → [Bracket] → [Bracket Type]	
Exposure Bracket	Press the shutter button to perform recording while adjusting the exposure. (P145)
Aperture Bracket	Press the shutter button to perform recording while adjusting the aperture. (P146) • Available in Aperture-Priority AE Mode or when the ISO sensitivity is set to [AUTO] in Manual Exposure Mode.
FOCUS Focus Bracket	Press the shutter button to perform recording while adjusting the focus position. (P146)
WB White Balance Bracket	Press the shutter button once to take three pictures with different white balance settings automatically. (P147)

2 Press ▲/▼ to select [More Settings] and then press [MENU/SET].

- For information on [More Settings], refer to the page that describes each function.
- Press the shutter button halfway to exit the menu.

3 Focus on the subject and take a picture.

- When Exposure Bracket is selected, the bracket display flashes until all of the pictures you have set are taken. If you change the bracket settings or turn off the camera before all of the pictures you have set are taken, the camera restarts recording from the first picture.

■ To cancel [Bracket Type]

Select [OFF] in step 1.

Not available in these cases:

- Bracket recording does not work in the following cases:
 - [Glistening Water]/[Glittering Illuminations]/[Handheld Night Shot]/[Soft Image of a Flower]/[Panorama Shot] (Scene Guide Mode)
 - [Rough Monochrome]/[Silky Monochrome]/[Miniature Effect]/[Soft Focus]/[Star Filter]/[Sunshine] (Creative Control Mode)
 - When recording using the flash (except for White Balance Bracket)
 - When recording motion pictures
 - When recording 4K photos
 - When recording with the Post Focus function
 - When using [Multi Exp.]
 - When using [Time Lapse Shot]
 - When using [Stop Motion Animation] (when [Auto Shooting] is set)
- White Balance Bracket does not work in the following cases:
 - Intelligent Auto Plus Mode
 - Creative Control Mode
 - When recording in Burst Mode
 - When [Quality] is set to [RAW₁], [RAW₂] or [RAW]

Exposure Bracket

■ About [More Settings] (step 2 in P144)

[Step]	Sets the number of pictures to be taken and the exposure compensation range. [3•1/3] (Takes three pictures with an interval of 1/3 EV) to [7•1] (Takes seven pictures with an interval of 1 EV)
[Sequence]	Sets the order in which pictures are taken.
[Single Shot Setting]*	[□]: Takes one picture each time you press the shutter button. [📷]: Takes all the pictures set to be taken when you press the shutter button once.

- * Not available for burst recording. When using burst recording, if you press and hold the shutter button, recording will be performed continuously until a specified number of pictures are taken.

[Step]: [3•1/3], [Sequence]: [0/–/+]

1st picture



±0 EV

2nd picture



–1/3 EV

3rd picture



+1/3 EV

- When taking pictures using Exposure Bracket after setting the Exposure Compensation value, the pictures taken are based on the selected Exposure Compensation value.

Aperture Bracket

Recording Mode: **A** **M**

About [More Settings] (step 2 in P144)

[Image Count]	[3], [5]: Takes a specified number of pictures with different aperture values within the range based on the initial aperture value. [ALL]: Takes pictures using all aperture values.
----------------------	---

• When using burst recording, if you press and hold the shutter button, recording will be performed until a specified number of pictures are taken.

The available aperture values vary depending on the lens.

Example: when using the interchangeable lens (H-FS12060)

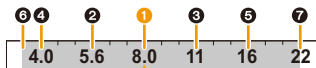

When the initial position is set to F8.0:

① first picture, ② second picture, ③ third picture... ⑦ seventh picture

Focus Bracket

About [More Settings] (step 2 in P144)

[Step]	Sets the interval between focus positions. • The distance by which the focus position moves in each step will be shorter if the initial position is closer to a subject, and conversely if the initial position is farther from a subject, the distance will be longer.
[Image Count]*	Sets the number of pictures to be taken.
[Sequence]	[0/-/+]: Alternately moves the focus position closer and farther away within the range centred on the initial position as you take pictures. [0/+:] Moves the focus position farther away from the initial position as you take pictures.

* Not available for burst recording. When using burst recording, if you press and hold the shutter button, recording will be performed continuously until a specified number of pictures are taken.



(A) Focus: closer

(B) Focus: farther away

① first picture, ② second picture... ⑤ fifth picture...

• Pictures taken with Focus Bracket are displayed as a set of group pictures.

White Balance Bracket

■ About [More Settings] (step 2 in P144)

Rotate the control dial to adjust the correction range, and press [MENU/SET].

: Horizontal ([A] to [B])

: Vertical ([G] to [M])

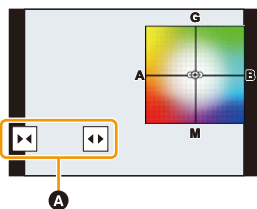

- You can also set the correction range by touching **A**.



6.















Stabiliser, Zoom and Flash



Image Stabiliser

The camera can use both the in-body image stabiliser and the in-lens image stabiliser. Of the Dual I.S. modes that effectively combine two image stabilisers, this supports Dual I.S.2 ( ,  , ) with high correction efficiency.

Furthermore, during motion picture recording, you can use the 5-Axis Hybrid Image Stabiliser that incorporates electronic stabilisation.

- The image stabilisers to be activated differ depending on your lens. The icon for the currently activated image stabiliser is displayed on the recording screen.

Attached lens	Available image stabiliser	Icons displayed	
		When taking pictures	When recording motion pictures
Panasonic lenses compatible with Dual I.S. Mode (Based on the Micro Four Thirds System standard)	Lens + Body (Dual I.S.)	 /  /  / 	 / 
Lenses compatible with the image stabiliser function (Based on the Micro Four Thirds System standard/ Four Thirds System standard)	Lens or Body	 / 	
Lenses not compatible with the image stabiliser function (Based on the Micro Four Thirds System standard/ Four Thirds System standard)	Body	 / 	
When using a Leica lens mount adaptor (optional) / Mount adaptor made by another manufacturer	Body	 / 	

- The 5-Axis Hybrid Image Stabiliser function can be used with all lenses. Set [E-Stabilization (Video)] in [Stabilizer] to [ON] in the [Rec] menu. The recording screen displays the following icons when [ON] is set:
 - Panasonic lenses compatible with Dual I.S. Mode: []/[]
 - Other than the above: []
- If the recording screen icon is not indicated with [DUAL2] or [DUAL] even when a supported lens is being used, update the lens firmware to the latest version. For the latest information on supported lenses or to download their firmware, refer to our website. (P13)

■ Using the Image Stabiliser

- When using a lens with an O.I.S. switch, set it to [ON].
- When using lenses without a function for communicating with this camera, a message asking you to check the focal length setting is displayed after you turn on the camera. Correctly operating the image stabilisation function requires that the focal length be set to match the attached lens. Set the focal length in accordance as prompted by the message. This can also be set using the menu. (P151)



Preventing jitter (camera shake)

When the jitter alert [] appears, use [Stabilizer], a tripod, the self-timer or the shutter remote control (DMW-RS2: optional).

- Shutter speed will be slower particularly in the following cases. Keep the camera still from the moment the shutter button is pressed until the picture appears on the screen. We recommend using a tripod.
 - Slow Sync.
 - Slow Sync./Red-Eye Reduction
 - [Clear Nightscape]/[Cool Night Sky]/[Warm Glowing Nightscape]/[Artistic Nightscape]/[Glittering Illuminations]/[Clear Night Portrait] (Scene Guide Mode)
 - When you set to a slow shutter speed

Image Stabiliser Settings





Applicable modes: **P** **A** **S** **M**

Set the image stabiliser movement to match the recording situation.

- When using an interchangeable lens with O.I.S. switch (such as H-FSA14140), stabiliser function is activated if the O.I.S. switch of the lens is set to [ON]. () is set at the time of purchase.)

MENU → **[Rec]/** **[Motion Picture]** → **[Stabilizer]**

[Operation Mode]	(Normal)	Camera shake is corrected for up/down, left/right, and rotational movements.	
	(Panning)	Camera shake is corrected for up/down movements. This mode is ideal for panning (a method of taking pictures which involves turning the camera to track the movements of a subject which continues to move in a fixed direction).	
	[OFF]	[Stabilizer] does not work. () • When using a lens with an O.I.S. switch, set the switch to [OFF].	
[E-Stabilization (Video)]	Jitter during motion picture recording is corrected along the vertical, horizontal, roll, pitch, and yaw axes by making use of the In-Lens Image Stabiliser, In-Body Image Stabiliser, and Electronic Image Stabiliser. (5-Axis Hybrid Image Stabiliser) [ON]/[OFF] • The angle of view may become narrower if this is set to [ON].		

   	<p>Allows you to enhance the image stabilisation effect during motion picture recording. This effect can keep the motion blur in the composition minimal when you want to perform recording from a fixed perspective.</p> <p>[ON]/[OFF]</p> <ul style="list-style-type: none"> This effect works only during recording.  is displayed on the recording screen. To change the composition during recording, set to [OFF] first, and then move the camera. Use the Fn button to switch between [ON]/[OFF] during recording. (P60) In situations where the focal length becomes greater, such as when a telephoto lens is attached, the stabilisation effect will be weaker. The stabilisation effect may be weak depending on the lens used. [I.S. Lock (Video)] is not available when using other manufacturer's lenses with an image stabilisation function.
<p>[Focal Length Set]</p>	<p>When using lenses without a function for communicating with this camera, manually set the focus length.</p>

Setting the focal length of a lens

1 Select the menu.

MENU →  **[Rec]/**  **[Motion Picture]** → **[Stabilizer]** → **[Focal Length Set]**

2 Enter a focal length.

◀/▶: Select the item (digit); ▲/▼: Setting

- A focal length ranging from 0.1 mm to 1000 mm can be set.

3 Press [MENU/SET].

■ Registering a focal length

- Enter a focal length.
- Press ▶ to select the focal length to be overwritten and then press [DISP.].
 - Up to 3 focal length settings can be registered.

■ Calling a registered focal length

Press ◀/▶ to select a registered focal length and then press [MENU/SET].

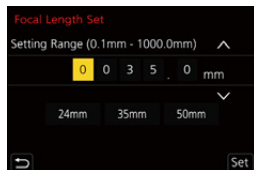

• **The Image Stabiliser may produce operational sound or cause vibration during its operation, but these are not malfunctions.**

- It is recommended to disable the Image Stabiliser when using a tripod.
- The stabiliser function may not be effective in the following cases.
 - When there is a lot of jitter
 - When the zoom magnification is high
 - When using the Digital Zoom
 - When taking pictures while following a moving subject
 - When the shutter speed becomes slower to take pictures indoors or in dark places
- The panning effect in [Panning] is more difficult to achieve in the following cases.
 - In brightly lit places such as in broad daylight on a summer's day
 - When the shutter speed is faster than 1/100 of a second
 - When you move the camera too slowly because the subject is moving slowly (The background will not become a blur)
 - When the camera does not keep up with the subject satisfactorily

 **Not available in these cases:**

- In the following cases, the [Stabilizer] will switch to [Panning], even if it is set to [Normal]:
 - [Panorama Shot] (Scene Guide Mode)
- In the following cases, the [Stabilizer] will switch to [Normal], even if it is set to [Panning]:
 - When recording motion pictures
 - When recording 4K photos
 - When recording with the Post Focus function
- In the following case, the [Stabilizer] will switch from [DUAL2] to [DUAL1] even when a compatible lens is being used:
 - When [High Speed Video] is set
- The 5-Axis Hybrid Image Stabiliser function is not available in the following cases:
 - When using the Digital Zoom
 - When [High Speed Video] is set
 - When [4K Live Cropping] is set

Taking Pictures with the Zoom

Optical zoom

Applicable modes:         

You can zoom-in to make people and objects appear closer or zoom-out to record landscapes, etc.

T side: Enlarges distant subject

W side: Widens angle of view

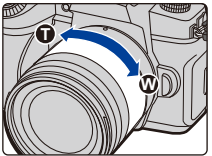
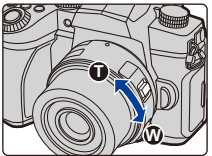
<p>Interchangeable lens with a zoom ring</p>	<p>Rotate the zoom ring.</p>	
<p>Interchangeable lens that supports the power zoom (electrically operated zoom)</p>	<p>Move the zoom lever. (The zoom speed varies depending on how far you move the lever.)</p> <ul style="list-style-type: none"> • If you assign [Zoom Control] to a Fn button, you can operate the optical zoom slowly by pressing ◀/▶ or fast by pressing ▲/▼. <p>For information on how to operate, refer to step 2 and the subsequent steps on P155.</p>	
<p>Interchangeable lens that does not support the zoom</p>	<p>The optical zoom is not available.</p>	

Raising the telescopic effect

[Ex. Tele Conv.]

Applicable modes:   **P** **A** **S** **M**    

Extra Tele Conversion enables you to take pictures that are further enlarged without deteriorating the picture quality.

Preparations:

- **When taking pictures:** Set [Picture Size] to [**EX** M] or [**EX** S], and [Quality] to other than [RAW].
- **When recording motion pictures:** Set the size for [Rec Quality] to [FHD] or [HD].

■ Maximum zoom magnifications when using Extra Tele Conversion

When taking pictures	[Ex. Tele Conv.] ([Rec])	1.3×: [EX M] (When [Aspect Ratio] is set to [16:9]) 1.4×: [EX M] (When [Aspect Ratio] is set to [4:3]/[3:2]/[1:1]) 2.0×: [EX S]
When recording motion pictures	[Ex. Tele Conv.] ([Motion Picture])	2.7× (motion pictures size is set to [FHD] in [Rec Quality]) 4.0× (motion pictures size is set to [HD] in [Rec Quality])

■ Increasing the zoom magnification in steps when taking pictures

1 Select the menu.

MENU → [Rec] → [Ex. Tele Conv.] → [ZOOM]

2 Set a Fn button to [Zoom Control]. (P60)

3 Press the Fn button.

4 Press ◀/▶ or ▲/▼.

▲/▶: Tele (Enlarges distant subject)

▼/◀: Wide (Widens angle of view)

- The zoom operation is terminated when the Fn button is pressed again or a certain amount of time passes.



(A) Optical Zoom range (Focal length)*

(B) Extra Tele Conversion range (Zoom magnification)

- * This zoom slider is displayed when using an interchangeable lens that supports the power zoom.



- A constant zoom speed will be set.
- The indicated zoom magnification is an approximation.
- You can also operate the zoom by using touch zoom. (P158)

■ Fixing the zoom magnification at the maximum level

MENU → [Rec] → [Ex. Tele Conv.] → [TELE CONV.]

MENU → [Motion Picture] → [Ex. Tele Conv.] → [ON]

[OFF]



[TELE CONV.]/[ON]

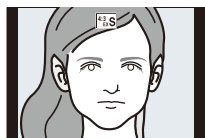

- If you assign [Ex. Tele Conv.] to [Fn Button Set] in the [Custom] ([Operation]) menu, you can display the Extra Tele Conversion setting screen for both pictures and motion pictures by pressing the assigned Fn button. While this screen is displayed, you can change the [Picture Size] setting by pressing [DISP].



Not available in these cases:

- This function is not available in the following cases:
 - [Panorama Shot] (Scene Guide Mode)
 - [Toy Effect]/[Toy Pop] (Creative Control Mode)
 - When [Quality] is set to [RAW]
 - When recording 4K photos
 - When recording with the Post Focus function
 - When [HDR] is set to [ON]
 - When using [Multi Exp.]
 - When [High Speed Video] is set to [120fps/FHD], [100fps/FHD], [90fps/FHD] or [75fps/FHD]
 - When [4K Live Cropping] is set
- [Ex. Tele Conv.] ([Rec]) is not available in the following case:
 - [Handheld Night Shot] (Scene Guide Mode)
- [Ex. Tele Conv.] ([Motion Picture]) is not available during HDMI output. (Except in Creative Video Mode)

[Digital Zoom]

Applicable modes:

Although the image quality deteriorates every time you zoom in further, you can zoom in up to four times the original zoom magnification.
(Continuous zooming is not possible.)

MENU → **[Rec]** / **[Motion Picture]** → **[Digital Zoom]** → **[4×]/[2×]**

- When using the Digital Zoom, we recommend using a tripod and the self-timer for taking pictures.



Not available in these cases:

- This function is not available in the following cases:
 - [Toy Effect]/[Toy Pop]/[Miniature Effect] (Creative Control Mode)
 - When [Quality] is set to [RAW_{Hi}], [RAW_{Lo}] or [RAW]
 - When recording with the Post Focus function
 - When [High Speed Video] is set
 - When [HDR] is set to [ON]
 - When using [Multi Exp.]

Changing the settings for a power zoom lens

Applicable modes:

Sets the screen display and lens operations when using an interchangeable lens that is compatible with power zoom (electrically operated zoom).

MENU → **[Custom]** → **[Lens / Others]** → **[Power Zoom Lens]**

<p>[Disp Focal Length]</p>	<p>When you zoom, the focal distance is displayed and you can confirm the zoom position.</p> <p>(A) Focal distance indication (B) Current focal distance</p>	
<p>[Step Zoom]</p>	<p>When you operate the zoom with this setting [ON], the zoom will stop at positions corresponding to predetermined distances.</p> <p>(C) Step zoom indication</p> <ul style="list-style-type: none"> This setting does not work when recording motion pictures or recording with [4K Pre-Burst]. 	
<p>[Zoom Speed]</p>	<p>You can set the zoom speed for zoom operations.</p> <ul style="list-style-type: none"> If you set [Step Zoom] to [ON], the zoom speed will not change. <p>[Photo]: [H] (High speed)/[M] (Middle speed)/[L] (Low speed) [Video]: [H] (High speed)/[M] (Middle speed)/[L] (Low speed)</p>	
<p>[Zoom Ring]</p>	<p>This may be selected when a power zoom-compatible lens with a zoom lever and zoom ring is attached.</p> <p>When set to [OFF], the operations controlled by the zoom ring are disabled to prevent accidental operation.</p>	

Zooming using touch operations (Touch zoom)

You can change the zoom magnification of Extra Tele Conversion with touch operation when using the optical zoom or taking pictures.

- When using an interchangeable lens that does not support power zoom (H-FS12060/H-FSA14140/H-FS1442A), you can operate the zoom magnification of Extra Tele Conversion by setting [Ex. Tele Conv.] ([Rec]) to [ZOOM].

1 Touch [].

2 Touch [].

- The slide bar is displayed.

3 Perform zoom operations by dragging the slide bar.

- The zoom speed varies depending on the touched position.

[]/[]	Zooms slowly
[]/[]	Zooms quickly

- To end touch zoom operations, touch [] again.



Using a Flash

Applicable modes: **[A]** **[Av]** **[P]** **[A]** **[S]** **[M]** **[M]** **[S]** **[M]**

■ Open/Close the built-in flash

(A) To open the flash

Slide the flash open lever.

- Be careful when opening the flash as the flash will jump out.

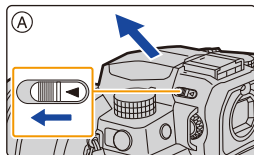

(B) To close the flash

Press the flash until it clicks.

- Be careful not to catch your finger, etc.
- Forcibly closing the flash can damage the camera.
- Be sure to close the built-in flash when not in use.

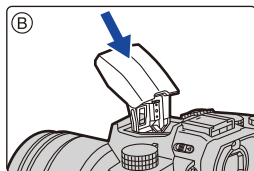

■ The available flash range (approximation)

When you use certain lenses, light from the flash may be blocked or fail to cover the lens field of view, causing dark areas to appear in the resulting pictures.

The distance at which light from the flash is blocked by lens, and the distance to which light from the flash is delivered vary depending on the lens used. Check the distance to the subject when taking a picture.

When the interchangeable lens (H-FS12060) is used	
Wide	Tele
0.5 m (1.6 feet) to 7.3 m (24 feet)	0.3 m (0.98 feet) to 4.5 m (15 feet)
When the interchangeable lens (H-FSA14140) is used	
Wide	Tele
0.5 m (1.6 feet) to 7.3 m (24 feet)	0.5 m (1.6 feet) to 4.5 m (15 feet)
When the interchangeable lens (H-FS1442A) is used	
Wide	Tele
0.5 m (1.6 feet) to 7.3 m (24 feet)	0.3 m (0.98 feet) to 4.5 m (15 feet)

- These ranges are obtained when the ISO sensitivity is set to [AUTO] and [ISO Auto Upper Limit Setting] in [ISO Sensitivity (photo)] is set to [AUTO].



Using the flash skilfully

When taking pictures with flash with the lens hood attached, the lower portion of the photo may turn dark and the control of the flash may be disabled because the photo flash may be obscured by the lens hood. We recommend detaching the lens hood.

- Do not perform the following, as heat or light may cause the object to deform or discolour:
 - Bringing any object near the flash
 - Blocking the flash with your hand while it is firing
 - Closing the flash while it is firing
- Do not close the flash immediately after a preliminary flash is fired by using a function such as Forced On/Red-Eye. This may cause a malfunction.
- When the remaining battery power becomes low or the flash is fired continuously, it may take time to charge the flash. While the flash is charging, the flash icon blinks red, and even if you fully press the shutter button, recording is not possible.
- When an external flash is attached, it will have priority over the built-in flash.
For information about external flashes: [\(P306\)](#)



MENU



Setting Flash Functions

You can set the flash function to control flash firing from the camera.

[Firing Mode]/[Manual Flash Adjust.]

Applicable modes:           

Select whether to set the flash output automatically or manually.

- This can be set when the built-in flash is used.

1 Select the menu.

MENU →  **[Rec]** → **[Flash]** → **[Firing Mode]**

[TTL]	The camera automatically sets the flash output.
[MANUAL]	Set the luminosity ratio of the flash manually. In [TTL] you can shoot the photograph you want even when shooting dark scenes that may otherwise be too brightly lit by the flash. <ul style="list-style-type: none"> • When [MANUAL] is set, the luminosity ratio ([1/1], etc.) is displayed on the flash icon on the screen.

2 (When [MANUAL] is selected)

Select the menu.

MENU →  **[Rec]** → **[Flash]** → **[Manual Flash Adjust.]**

3 Press ◀/▶ to set the luminosity ratio and then press [MENU/SET].

- You can set from [1/1] (full brightness) to [1/128] in steps of 1/3.

[Flash Mode]

Applicable modes: **P** **A** **S** **M**

Set the flash to match the recording.

MENU → **[Rec]** → **[Flash]** → **[Flash Mode]**

(Forced Flash On) (Forced On/Red-Eye)*	<p>The flash is activated every time regardless of the recording conditions.</p> <ul style="list-style-type: none"> • Use this when your subject is back-lit or under fluorescent light.
(Slow Sync.) (Slow Sync./Red-Eye)*	<p>When taking pictures against a dark background landscape, this feature will slow the shutter speed when the flash is activated. Dark background landscape will appear brighter.</p> <ul style="list-style-type: none"> • Use this when you take pictures of people in front of a dark background. • Using a slower speed can cause motion blur. Using a tripod can enhance your photos.
(Forced Flash Off)	<p>The flash is not fire.</p>

* Set [Flash] to the following settings:

- [Wireless]: [OFF]
- [Firing Mode]: [TTL]

• In Intelligent Auto Plus Mode () , [] or [] can be set.

Refer to page 67 for information about flash settings during Intelligent Auto Mode (or).

• Some flash modes may not be available depending on the external flash's settings.

The flash is activated twice.

The interval between the first and second flash is longer when [] or [] is set. The subject should not move until the second flash is activated.

• The Red-Eye Reduction effect differs between people. Also, if the subject was far away from the camera or was not looking at the first flash, the effect may not be evident.

■ Shutter speed for each flash setting

Flash setting	Shutter speed (Sec.)	Flash setting	Shutter speed (Sec.)
	1/60* to 1/200		1 to 1/200

* This becomes 60 seconds in Shutter-Priority AE Mode and B (Bulb) in the Manual Exposure Mode.

• In Intelligent Auto (or) Mode, shutter speed changes depending on the identified scene.

■ Available flash settings by Recording Mode

The available flash settings depend on the Recording Mode.

(○: Available, —: Not available, ●: Initial setting of Scene Guide Mode)

Recording Mode		⚡	⚡Ⓞ	⚡S	⚡SⓄ	Ⓞ
P	Programme AE Mode	○	○	○	○	○
A	Aperture-Priority AE Mode	○	○	○	○	○
S	Shutter-Priority AE Mode	○	○	—	—	○
M	Manual Exposure Mode	○	○	—	—	○
	[Clear Portrait]	○	●	—	—	○
	[Silky Skin]	○	●	—	—	○
	[Clear in Backlight]	●	—	—	—	○
	[Sweet Child's Face]	○	●	—	—	○
SCN	[Clear Night Portrait]	—	—	—	●	○
Scene Guide Mode	[Soft Image of a Flower]	●	—	—	—	○
	[Appetizing Food]	●	—	—	—	○
	[Cute Dessert]	●	—	—	—	○
	[Freeze Animal Motion]	●	—	—	—	○
	[Clear Sports Shot]	●	—	—	—	○
	[Monochrome]	●	○	○	○	○

• In the following cases, the flash mode is fixed to [Ⓞ]:

- When the flash is closed (except when an external flash is being used)
- [Backlit Softness]/[Relaxing Tone]/[Distinct Scenery]/[Bright Blue Sky]/[Romantic Sunset Glow]/[Vivid Sunset Glow]/[Glistening Water]/[Clear Nightscape]/[Cool Night Sky]/[Warm Glowing Nightscape]/[Artistic Nightscape]/[Glittering Illuminations]/[Handheld Night Shot]/[Panorama Shot] (Scene Guide Mode) (P82)
- When recording motion pictures (P169)
- When recording 4K photos (P122)
- When recording with the Post Focus function (P133)
- When using the electronic shutter (P206)
- When using [Filter Settings] (P199)
- When [Silent Mode] is set to [ON] (P206)
- When [HDR] is set to [ON] (P208)

• The Scene Guide Mode flash setting is returned to the initial value with each change of scene.

[Flash Synchro]



Applicable modes:          



When a moving subject is recorded at night using a slow shutter and flash, a trail of light may appear in front of the subject.

If you set [Flash Synchro] to [2ND], you can take a dynamic picture with a trail of light appearing behind the subject by firing the flash immediately before the shutter closes.

Preparation: Set [Wireless] in [Flash] to [OFF].

MENU →  **[Rec]** → **[Flash]** → **[Flash Synchro]**

[1ST]	1st curtain synchro The normal method when taking pictures with the flash.	
[2ND]	2nd curtain synchro The light source appears behind the subject and picture becomes dynamic.	

- [2nd] is displayed in the flash icon on the screen if you set [Flash Synchro] to [2ND].
- When a fast shutter speed is set, the effect of [Flash Synchro] may deteriorate.
- You cannot set [] or [] when [Flash Synchro] is set to [2ND].
- The [Flash Synchro] settings also apply to an external flash. (P306)

Adjusting the Flash Output

Applicable modes:   **P A S M**   

Adjust the flash brightness when pictures taken with the flash are over or underexposed.

Preparation: Set [Wireless] and [Firing Mode] in [Flash] to [OFF] and [TTL], respectively.

1 Select the menu.

MENU →  [Rec] → [Flash] → [Flash Adjust.]

2 Press **◀/▶** to set the flash output and then press **[MENU/SET]**.

- You can adjust from [-3 EV] to [+3 EV] in steps of 1/3 EV.
- Select [±0] to return to the original flash output.

- [+] or [-] is displayed on the flash icon in the screen when the flash level is adjusted.
- The [Flash Adjust.] setting also applies to an external flash. (P306)

[Auto Exposure Comp.]

Applicable modes:   **P A S M**   

The flash output is automatically adjusted in accordance with the exposure compensation value.

MENU →  [Rec] → [Flash] → [Auto Exposure Comp.]

Settings: [ON]/[OFF]

- For details on Exposure Compensation, refer to P111.
- The [Auto Exposure Comp.] settings also apply to an external flash. (P306)

Recording Using a Wireless Flash

Applicable modes:  P A S M

Flashes compatible with this camera (DMW-FL580L/DMW-FL360L/DMW-FL200L: optional) come with the wireless recording function.

With this function, you can separately control the firing of three flash groups and the built-in flash (or the flash attached to the hot shoe of the camera).

■ Placing wireless flashes

Place the wireless flash with its wireless sensor facing toward the camera.

The following figure shows the estimated controllable range when you take pictures by holding the camera horizontally. Controllable range differs depending on the surrounding environment.

Placement range

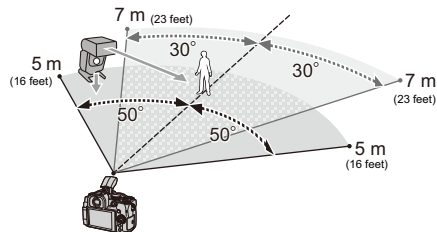

Placement example

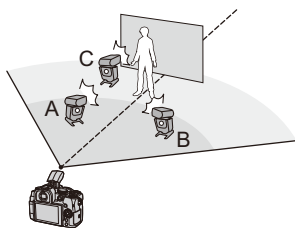

- In this placement example, flash C is placed to erase the shadow of the subject that flashes A and B will create.
- The recommended number of wireless flashes for each group is three or less.
- If the subject is too close, signal flashing may affect the exposure.
If you set [Communication Light] to [LOW] or lower the output with a diffuser or similar product, the effect will be reduced.

Preparation:

Slide the flash open lever on the camera to open the flash, or attach the Flash (optional) to the camera.

1 Set the wireless flashes to RC Mode and then place them.

- Set a channel and groups for the wireless flash.

2 Select the menu.

MENU →  [Rec] → [Flash]	
[Wireless]	Select [ON]. The flash icon on the screen will be indicated with [WL].
[Wireless Channel]	Select the channel you have set for the wireless flashes in step 1.
[Wireless Setup]	Proceed to step 3.

3 Press ▲/▼ to select an item and then press [MENU/SET].

• To fire a test flash, press [DISP].

- (A) Flash output
- (B) Luminosity ratio
- (C) Firing Mode

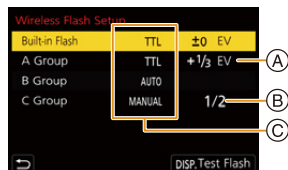

[Built-in Flash] ^{*1} / [External Flash] ^{*1}	[Firing Mode]	[TTL]: The camera automatically sets the output. [AUTO] ^{*2,3} : Flash output is set by the external flash. [MANUAL] ^{*3} : Set the luminosity ratio of the external flash manually. [OFF]: The flash on the camera side emits only communication light.
	[Flash Adjust.]	Set the flash output of the camera manually when [Firing Mode] is set to [TTL].
	[Manual Flash Adjust.]	Set the luminosity ratio of the external flash when [Firing Mode] is set to [MANUAL]. • You can set from [1/1] (full brightness) to [1/128] in steps of 1/3.
[A Group]/ [B Group]/ [C Group]	[Firing Mode]	[TTL]: The camera automatically sets the output. [AUTO] ^{*1} : The wireless flashes automatically set the output. [MANUAL]: Set the luminosity ratio of the wireless flashes manually. [OFF]: The wireless flashes of the specified group will not fire.
	[Flash Adjust.]	Adjust the output of the wireless flashes manually when [Firing Mode] is set to [TTL].
	[Manual Flash Adjust.]	Set the luminosity ratio of the wireless flashes when [Firing Mode] is set to [MANUAL]. • You can set from [1/1] (full brightness) to [1/128] in steps of 1/3.

*1 Not available when [Wireless FP] is set to [ON].

*2 This option is not displayed when the flash (DMW-FL200L: optional) is attached to the camera.

*3 Available when an external flash is attached.

Using other settings for wireless flash recording

[Wireless FP]

During wireless recording, an external flash fires an FP flash (high speed repetition of flash firing). This firing allows recording with the flash at a fast shutter speed.

MENU →  **[Rec]** → **[Flash]** → **[Wireless FP]**

Settings: **[ON]/[OFF]**

[Communication Light]

Set the strength of communication light.

MENU →  **[Rec]** → **[Flash]** → **[Communication Light]**

Settings: **[HIGH]/[STANDARD]/[LOW]**

Recording Motion Picture

Applicable modes:   P A S M   

This camera can record full high definition motion pictures compatible with the AVCHD format or motion pictures recorded in MP4. In addition, the camera can record 4K motion pictures in MP4.

Audio will be recorded in stereo.

1 Start recording by pressing the motion picture button.

- (A) Elapsed recording time
- (B) Available recording time

- Recording of motion picture appropriate for each mode is possible.
- The recording state indicator (red) © will light up while recording motion pictures.
- If no operation is performed, part of the information on the screen will gradually become darker after approximately 10 seconds has passed, and will no longer be displayed after approximately 1 minute has passed.

Pressing the [DISP.] button or touching the monitor will make the display reappear.

This operation is to prevent screen burn-in and is not a malfunction.

- Release the motion picture button right after you press it.
- m: minute, s: second

2 Stop the recording by pressing the motion picture button again.

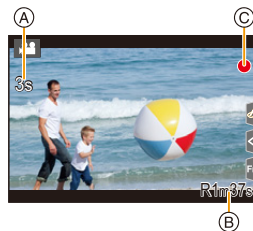
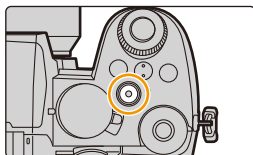

- **With recording in a quiet environment, the sound of aperture and focus may be recorded in motion pictures. This is not a malfunction.**

The focus operation during recording of motion pictures can be set to [OFF] in [Continuous AF] (P172).



If the operation sound of the motion picture button pressed to end recording bothers you, try the following:

- Record the motion picture about three seconds longer, and then divide the last part of the motion picture using [Video Divide] in the [Playback] menu.
- Use the Shutter Remote Control (DMW-RS2: optional) to record.

- When the ambient temperature is high or a motion picture is recorded continuously, the camera may display [,] and then stop the recording. Wait until the camera cools down.
- ISO sensitivity operates as [AUTO] (for motion pictures) during motion picture recording. In Creative Video Mode, you can set the ISO sensitivity for motion picture recording.
- You can display the available recording time before recording in Creative Video Mode.
- When the aspect ratio setting is different in still and motion pictures, the angle of view changes at the start of motion picture recording. When [Rec Area] in the [Custom] ([Monitor / Display]) menu is set to [,], angle of view during motion picture recording is displayed.
- The operational sound of the zoom or button operation may be recorded when it is operated during the recording of a motion picture.
- The functions available when recording motion pictures differ according to the lens you are using, and the operational sound of the lens may be recorded.
- Depending on the type of the card, the card access indication may appear for a while after recording motion pictures. This is not a malfunction.
- The Recording Mode will switch when you record motion pictures in the following Scene Guide Modes.

Scene Guide Mode	Recording Mode while recording motion picture
[Clear in Backlight]	Portrait Mode
[Clear Nightscape]/[Artistic Nightscape]/[Handheld Night Shot]/[Clear Night Portrait]	Low Light Mode

Not available in these cases:

- Motion pictures cannot be recorded in the following cases.
 - [Glistening Water]/[Glittering Illuminations]/[Soft Image of a Flower]/[Panorama Shot] (Scene Guide Mode)
 - [Rough Monochrome]/[Silky Monochrome]/[Soft Focus]/[Star Filter]/[Sunshine] (Creative Control Mode)
 - When recording with the Post Focus function
 - When taking pictures with [Time Lapse Shot]
 - When using [Stop Motion Animation]

[Rec Format]/[Rec Quality]

These set the recording format and recording quality for motion picture recording. This camera can record motion pictures in 4K (3840×2160) or full high-definition (1920×1080) resolution. The image quality settings that can be selected vary depending on the [Rec Format] setting.

1 Select the menu.

MENU →  **[Motion Picture]** → **[Rec Format]**

[AVCHD]	This data format is suitable for when playing back on a high-definition TV, etc.
[MP4]	This data format is suitable for when playing back on a PC, etc.

2 Press ▲/▼ to select [Rec Quality] and then press [MENU/SET].

When [AVCHD] is selected

Item	Size	Recording frame rate	Sensor output	Bit rate
[FHD/28M/50p]^{*1}	1920×1080	50p	50 frames/second	28 Mbps
[FHD/17M/50i]	1920×1080	50i	50 frames/second	17 Mbps
[FHD/24M/25p]	1920×1080	50i	25 frames/second	24 Mbps
[FHD/24M/24p]	1920×1080	24p	24 frames/second	24 Mbps

*1 AVCHD Progressive

When [MP4] is selected

Item	Size	Recording frame rate	Sensor output	Bit rate
[4K/100M/30p]^{*2}	3840×2160	30p	30 frames/second	100 Mbps
[4K/100M/25p]^{*2}	3840×2160	25p	25 frames/second	100 Mbps
[4K/100M/24p]^{*2}	3840×2160	24p	24 frames/second	100 Mbps
[FHD/28M/60p]	1920×1080	60p	60 frames/second	28 Mbps
[FHD/28M/50p]	1920×1080	50p	50 frames/second	28 Mbps
[FHD/20M/30p]	1920×1080	30p	30 frames/second	20 Mbps
[FHD/20M/25p]	1920×1080	25p	25 frames/second	20 Mbps
[HD/10M/30p]	1280×720	30p	30 frames/second	10 Mbps
[HD/10M/25p]	1280×720	25p	25 frames/second	10 Mbps

*2 4K motion pictures

- The higher the Bit rate value is, the higher the picture quality becomes. Since the camera employs the VBR recording method, the bit rate is changed automatically depending on the subject to record. As a result, the recording time is shortened when a fast-moving subject is recorded.
- When [Miniature Effect] is selected for Creative Control Mode, you cannot select the items used for 4K motion pictures.
- When recording motion pictures in 4K, use a card rated as UHS Speed Class 3.
- When you record 4K motion pictures, the angle of view will be narrower than motion pictures of other sizes.
- To ensure highly accurate focus, 4K motion pictures are recorded at reduced AF speeds. It may be difficult to focus on the subject with AF, but this is not a malfunction.
- Refer to P34 for information about continuous recordable times.
- Depending on the TV to be connected, MP4 motion pictures recorded with [4K/100M/30p], [FHD/28M/60p], [FHD/20M/30p] or [HD/10M/30p] may not be played back correctly.

■ About the compatibility of the recorded motion pictures

Motion pictures in AVCHD and MP4 formats may not be played back even on devices that support these formats. In other cases, the motion pictures may be played back with poor image or sound quality or their recording information may not be displayed correctly. In these cases, play them back on the camera.

- To play back or import motion pictures in AVCHD format using another device, use a Blu-ray disc recorder that supports the format or a PC installed with the software "PHOTOfunSTUDIO".
- For details about 4K motion pictures recorded with the camera, refer to "Watching/Saving 4K Motion Pictures on an External Device" on P293.

[Continuous AF]

Applicable modes:         

You can select how to set the focus in AF when recording motion pictures.

MENU →  [Motion Picture] → [Continuous AF]

Focus mode	[Continuous AF]	Description of settings
[AFS]/[AFF]/ [AFC]	[ON]	The camera automatically keeps focusing on subjects during recording.
	[OFF]	The camera maintains the focus position at the start of recording.
[MF]	[ON]/[OFF]	You can focus manually.

- When the focus mode is set to [AFS], [AFF] or [AFC], if you press the shutter button halfway while recording a motion picture, the camera will re-adjust the focus.
- Depending on the recording conditions or lens used, operational sound may be recorded when the AF is operated while recording a motion picture. It is recommended to record with [Continuous AF] in the [Motion Picture] menu set to [OFF], if the sound of operation bothers you to avoid recording the lens noise.
- When operating the zoom while recording motion pictures, it may take time to come into focus.

 **Not available in these cases:**

- [Continuous AF] is not available in the following case:
 - When [High Speed Video] is set
- [Continuous AF] does not work in the following case:
 - When [Pull Focus] in [Snap Movie] is operating

[AF Custom Setting(Video)]

Applicable modes:   **P** **A** **S** **M**   

You can fine-adjust the focusing method for motion picture recording using [Continuous AF].

Preparation: Set [Continuous AF] to [ON].

MENU →  **[Motion Picture]** → **[AF Custom Setting(Video)]**

[ON]	Enables the following settings.	
[OFF]	Disables the following settings.	
[SET]	[AF Speed]	<p>[+] side: Focus moves at a faster speed.</p> <p>[-] side: Focus moves at a slower speed.</p>
	[AF Sensitivity]	<p>[+] side: When the distance to the subject changes significantly, the camera immediately readjusts the focus.</p> <p>[-] side: When the distance to the subject changes significantly, the camera waits for a little before readjusting the focus.</p>

Log recording (V-Log L)

Applicable modes: P A S M

You can perform log recording by setting [Photo Style] to [V-Log L]. It allows you to create images finished with rich gradation through post production editing.

1 Select the menu.

MENU → [Motion Picture] → [Photo Style]

2 Press ◀/▶ to select [V-Log L] and then press [MENU/SET].

- The recording screen and images output via HDMI will appear darker overall.

• LUTs (Look-Up Tables) can be used for post-production editing. You can download LUT data from the support site below.

<https://panasonic.jp/support/global/cs/dsc/>

(This Site is English only.)



This camera records motion pictures in 4:2:0/8 bit, so after post-production editing, luminance and colour unevenness or noise may appear in areas such as blue skies, people's skin, and white walls.

We recommend performing trial recording in advance and editing and checking post-production images before proceeding to actual recording.

Recording still pictures while recording motion pictures

Applicable modes:   **P** **A** **S** **M**   

You can record still pictures while recording a motion picture. (Simultaneous recording)

During motion picture recording, press the shutter button fully to record a still picture.



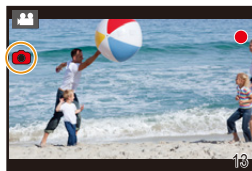

- Simultaneous recording indicator is displayed while recording still pictures.
- Recording with the Touch Shutter function is also available.



■ Setting the motion picture priority or still picture priority mode

Applicable modes:   **P** **A** **S** **M**   

MENU →  **[Motion Picture]** → **[Picture Mode in Rec.]**

 [Video Priority]	<ul style="list-style-type: none"> • Pictures will be recorded with a picture size determined by the [Rec Quality] setting for motion pictures. • Only JPEG images are recorded when [Quality] is set to [RAW , [RAW ] or [RAW]. (When set to [RAW], still pictures will be recorded in [Quality] of .) • You can take up to 40 still pictures. (Up to 10 still pictures during 4K motion picture recording)
 [Photo Priority]	<ul style="list-style-type: none"> • Pictures will be recorded with the set picture size and quality. • The screen will go dark while recording pictures. A still picture will be recorded in the motion picture during that period, and audio is not recorded. • You can take up to 10 still pictures. (Up to 5 still pictures during 4K motion picture recording)

- The picture aspect ratio will be fixed to [16:9].



Not available in these cases:

- When  (Photo Priority) is set, simultaneous recording is not possible in the following cases:
 - When [Rec Quality] is set to a motion picture item with a frame rate of [24p]
 - When the drive mode is set to 4K Photo
 - When using [Ex. Tele Conv.] in the [Motion Picture] menu
- Simultaneous recording is not possible when [Snap Movie] is set to [ON].

[Snap Movie]

Applicable modes:         

You can specify the recording time in advance and record motion pictures casually like you take snapshots. The function also allows you to shift a focus at the start of recording and add fade in/out effects in advance.

- Motion pictures will be recorded with [FHD/20M/25p] in [MP4].
- Using the smartphone/tablet app “Panasonic Image App”, you can combine motion pictures recorded with the camera. Music can be added and various editing operations can be performed when you combine them. (P275)

1 Select the menu.

MENU →  **[Motion Picture]** → **[Snap Movie]** → **[ON]**

- Press the shutter button halfway to exit the menu.

2 Start recording by pressing the motion picture button.

- Ⓐ Elapsed recording time
 - Ⓑ Set recording time
 - Release the motion picture button right after you press it.
 - You cannot stop motion picture recording in the middle.
- The recording will stop automatically when the set recording time has elapsed.

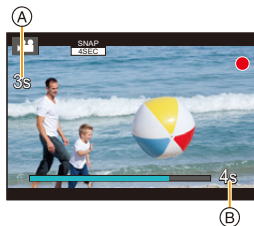

- **To cancel Snap Movie**
Select **[OFF]** in step 1.

Snap Movie settings

MENU →  [Motion Picture] → [Snap Movie] → [SET]

[Record time]	Sets the recording time of motion pictures.
[Pull Focus]	Shifts focus gradually at the start of recording for more dramatic imaging expression. (P178)
[Fade]	<p>Adds a fade-in (gradual appearance) effect to an image and audio as recording starts or adds a fade-out (gradual disappearance) effect to them as recording ends.</p> <p>[WHITE-IN]/[WHITE-OUT]: Adds a fade-in or fade-out effect that uses a white screen.</p> <p>[BLACK-IN]/[BLACK-OUT]: Adds a fade-in or fade-out effect that uses a black screen.</p> <p>[COLOR-IN]/[COLOR-OUT]: Adds an effect that fades in from black-and-white to colour or an effect that fades out from colour to black-and-white. Audio will be recorded normally.</p> <p>[OFF]</p>

- Motion pictures recorded with [WHITE-IN] or [BLACK-IN] are displayed as all-white or all-black thumbnails in Playback Mode.
- If you set [Snap Movie] in [Fn Button Set] (P60) of the [Custom] ([Operation]) menu and then press the Fn button, a screen that lets you switch [Snap Movie] between [ON]/[OFF] is displayed. You can change the settings of Snap Movie by pressing [DISP.] in this switching screen display.
- [Snap Movie] will be set to [OFF] when you connect to Wi-Fi with [Remote Shooting & View].
- This function is not available in the following cases:
 - [Miniature Effect] (Creative Control Mode)
 - When recording 4K photos
 - When recording with the Post Focus function
 - When [High Speed Video] is set
 - When [4K Live Cropping] is set

■ Setting [Pull Focus]

Set the frames that specify the positions where the [Pull Focus] starts (first position) and stops (second position).

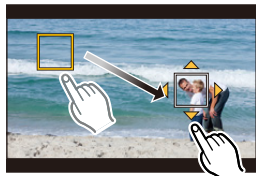

Button operation

- 1 Press **◀**.
- 2 Press **▲/▼/◀/▶** to move the AF area frame, and press **[MENU/SET]**. (**First position**)
 - If you press **[DISP.]** before pressing **[MENU/SET]**, the frame will return to the centre.
- 3 Repeat **step 2.** (**Second position**)
 - Press **[MENU/SET]** to cancel the second frame position setting.



Touch operation

Touch a subject (first position), drag your finger to the desired location (second position), and release the finger.

- If you touch **[ AF Off]**, the frame settings will be cancelled.



- A greater effect can be achieved by creating a striking contrast of focus between the start and end positions, for example by shifting focus from the background to foreground, or vice versa.
- After setting focus, try to keep the distance between the subject and the camera constant.

- When the camera fails to set the frame, it returns to the first position.
- When [Pull Focus] is set to [ON]:
 - AF Mode will be switched to [, a setting specially designed for [Pull Focus].
 - During picture taking, AF operates as [] at the first frame position.
- When the [Metering Mode] (P201) is set to [, the spot metering target is set at the first frame.



Not available in these cases:

- This function is not available in the following cases:
 - During MF
 - When using the Digital Zoom

Displaying/Setting the Sound Recording Level

[Sound Rec Level Disp.]

Applicable modes:        

Display the sound recording level on the recording screen.

MENU →  **[Motion Picture]** → **[Sound Rec Level Disp.]**

Settings: [ON]/[OFF]

• When [Sound Rec Level Limiter] is set to [OFF], [Sound Rec Level Disp.] is fixed to [ON].

[Sound Rec Level Adj.]

Applicable modes:        

Adjust the sound input level to 19 different levels (−12 dB to +6 dB).

MENU →  **[Motion Picture]** → **[Sound Rec Level Adj.]**

• Displayed dB values are approximate.

[Sound Rec Level Limiter]

Applicable modes:        

The camera adjusts the sound input level automatically, minimising the sound distortion (crackling noise) when the volume is too high.

MENU →  **[Motion Picture]** → **[Sound Rec Level Limiter]**

Settings: [ON]/[OFF]

Creative Video Mode

Recording Mode: 

It is possible to manually change the aperture, shutter speed and ISO sensitivity and record motion pictures.

The following motion pictures can only be recorded in Creative Video Mode:

[High Speed Video]	P181
[4K Live Cropping]	P182

1 Set the mode dial to .

2 Select the menu.

MENU →  [Creative Video] → [Exposure Mode] → [P]/[A]/[S]/[M]

- The operation for changing the aperture value or shutter speed is the same as the operation for setting the mode dial to P, A, S or M.
- Programme Shift does not work.





It is also possible to display the selection screen by touching the Recording Mode icon in recording screen.



3 Press the motion picture button (or shutter button) to start recording.

- The operational sound of the zoom or button operation may be recorded when it is operated during the recording of a motion picture.
Using touch icons allows silent operation while recording motion pictures.

- 1 Touch . (This cannot be used when recording with High Speed Video.)
- 2 Touch icon.

: Zoom*

: Exposure Compensation

F: Aperture value

ISO: ISO sensitivity

SS: Shutter speed

: Sound rec level adjustment

* When using an interchangeable lens that supports power zoom (electronic zoom)

- 3 Drag the slide bar to set.

[▼]/[▲]: Changes the setting slowly

[▼]/[▲]: Changes the setting quickly

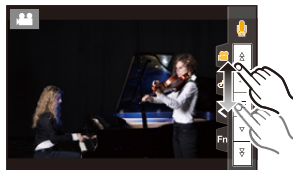

4 Press the motion picture button (or shutter button) again to stop recording.

■ [AUTO] ISO sensitivity settings

Set the upper and lower limits of the ISO sensitivity when it is set to [AUTO].

MENU →  **[Motion Picture]** → **[ISO Sensitivity (video)]**

[ISO Auto Lower Limit Setting]	[200]/[400]/[800]/[1600]/[3200]
[ISO Auto Upper Limit Setting]	[AUTO]/[400]/[800]/[1600]/[3200]/[6400]

[High Speed Video]

Records slow motion pictures of MP4 format by performing ultra-high-speed recording.

• Use a UHS Speed Class 3 card.

- 1 Set the mode dial to [M].
- 2 Select the menu.

MENU →  **[Creative Video]** → **[High Speed Video]**

Settings	Frame rate (for recording)	[Rec Quality] (for storage)	Slow motion effect
[120fps/FHD]	120 frames/second	FHD/20M/30p	Approx. 1/4×
[100fps/FHD]	100 frames/second	FHD/20M/25p	Approx. 1/4×
[90fps/FHD]	90 frames/second	FHD/20M/30p	Approx. 1/3×
[75fps/FHD]	75 frames/second	FHD/20M/25p	Approx. 1/3×
[60fps/FHD]	60 frames/second	FHD/20M/30p	Approx. 1/2×
[50fps/FHD]	50 frames/second	FHD/20M/25p	Approx. 1/2×
[OFF]		—	

- 3 Press the motion picture button (or shutter button) to start recording.
- 4 Press the motion picture button (or shutter button) again to stop recording.

- The angle of view becomes narrower in the following case:
 - When [120fps/FHD], [100fps/FHD], [90fps/FHD] or [75fps/FHD] is set
- AF does not work.
- Audio is not recorded.
- When using an interchangeable lens with no focus ring, you cannot set focus with MF.
- Under fluorescent lighting, flicker or horizontal bars may be seen.

[4K Live Cropping]

By cropping your motion picture down from the 4K angle of view to Full High Definition, you can record a motion picture that pans and zooms in/out while leaving the camera in a fixed position.



Pan

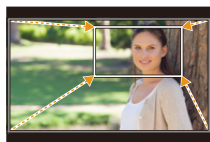

Zoom in

- [Rec Format] and [Rec Quality] in the [Motion Picture] menu will be fixed to [MP4] and [FHD/20M/30p]/[FHD/20M/25p], respectively.
- Hold the camera firmly in place while recording.
- The angle of view becomes narrower.

- 1 Set the mode dial to [M].
- 2 Select the menu.



MENU → **[Creative Video]** → **[4K Live Cropping]** → **[40SEC]/[20SEC]**

- 3 Set the cropping start frame.

(A) Cropping start frame

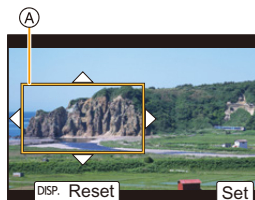
- When making settings for the first time, a cropping start frame of size 1920×1080 is displayed. (After setting the cropping start frame and end frame, the start frame and end frame that you set immediately before will be displayed.)
- The camera will remember the frame position and size even when the camera is turned off.



Button operation	Touch operation	Description of operation	
▲/▼/◀/▶	Touching	Moves the frame.	
 / 	—	Enlarges/reduces the frame in small steps.	The range of settings allowed is from 1920×1080 to 3840×2160.
	Pinching out/in	Enlarges/reduces the frame.	
[DISP.]	[Reset]	Returns the position of the frame to the centre and its size to the default setting.	
[MENU/SET]	[Set]	Decides the position and size of the frame.	

4 Set the cropping end frame.

- Ⓑ Cropping end frame

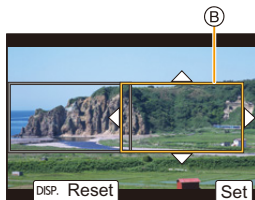
**5 Press the motion picture button (or shutter button) to start recording.**

- Ⓒ Elapsed recording time

- Ⓓ Set operating time

- Immediately release the motion picture button (or the shutter button) after pressing it.
- When the set operating time has elapsed, recording automatically ends.

To end recording midway, press the motion picture button (or the shutter button) again.



To add zoom in/out effects, set different angles of view for the cropping start and end frames. For example, to zoom in while recording, set a larger angle of view for the start frame and a smaller angle of view for the end frame.

■ Changing the position and size of a crop frame

Press ◀ while the recording screen is displayed, and perform steps **3** and **4**.

■ To cancel [4K Live Cropping] recording

Set [4K Live Cropping] to [OFF] in step **2**.

- The setting of the AF Mode switches to [☑]. (The eye to be in focus is not indicated.)
- Brightness is measured and focus is done in the cropping start frame. During motion picture recording, they are done in the crop frame. To lock the focus position, set [Continuous AF] to [OFF], or set the Focus Mode to [MF].
- [Metering Mode] will be [☑] (Multiple).

**Not available in these cases:**

- This function is not available in the following cases:
 - When [High Speed Video] is set

Playing Back Pictures

1 Press [▶].



2 Press ◀/▶.

◀: Play back the previous picture

▶: Play back the next picture

- If you press and hold ◀/▶, you can play back the pictures in succession.
- You can also perform this step by operating the camera as below.



Sending images	<ul style="list-style-type: none"> • Rotate the front dial or the control dial. • Drag the screen horizontally.
Sending images continuously	<ul style="list-style-type: none"> • After dragging to change the image, leave your finger touching the left or right edge of the screen.

■ To finish playback

Press [▶] again or press the shutter button halfway.

Not available in these cases:

- This camera complies with the DCF standard “Design rule for Camera File system” established by JEITA “Japan Electronics and Information Technology Industries Association” and with Exif “Exchangeable Image File Format”.
This camera can only display pictures that comply with the DCF standard.
- The camera may not play back images recorded on other devices correctly, and the functions of the camera may not be available for the images.

Playing Back Motion Pictures

This unit was designed to play motion pictures using the AVCHD and MP4 formats.

Select an icon indicated with [A], and then press ▲ to play it back.

(A) Motion picture recording time

- After playback starts, the elapsed playback time is displayed on the screen.
For example, 8 minutes and 30 seconds is displayed as [8m30s].
- Some information (recording information, etc.) is not displayed for motion pictures recorded in [AVCHD].
- Touching [▶] in the middle of the screen allows you to play back motion pictures.
- Motion pictures recorded with [Snap Movie] are played back automatically.



■ Operations during Motion Picture Playback

Button operation	Touch operation	Description of operation	Button operation	Touch operation	Description of operation
▲	▶/	Play/Pause	▼	■	Stop
◀	◀◀	Fast rewind*1	▶	▶▶	Fast forward*1
	◀	Frame-by-frame rewind (while pausing)*2		▶	Frame-by-frame forward (while pausing)
⊙	-	Reduce volume level	⊙	+	Increase volume level

*1 The fast forward/rewind speed increases if you press ▶/◀ again.

*2 When a motion picture recorded with [AVCHD] is rewound frame-by-frame, its frames will be shown in intervals of approximately 0.5 seconds.

■ Operations during automatic Snap Movie playback

▲	Playback from the beginning
◀	Back to previous picture
▶	Ahead to next picture

• If you touch the screen, automatic playback will stop.

• You can play back motion pictures on a PC with "PHOTOfunSTUDIO".

Extracting a Picture

Extract one frame of a motion picture and save it as a JPEG image.

1 Press **▲** to pause motion picture playback.

- Press ◀▶ to fine-adjust the pause position while the motion picture is paused.

2 Press [MENU/SET].

- The same operation can be performed by touching [].



- Still pictures will be saved with [Aspect Ratio] set to [16:9] and [Quality] set to []. The number of pixels will differ according to the motion picture you play back.

Motion picture recording quality	Picture size of the picture to be saved
[4K]	3840×2160
[FHD]/[HD]	1920×1080

- Still pictures created from a motion picture may be coarser than with normal picture quality.
- [] is displayed during playback of still pictures created from motion pictures.

Switching the Display Mode

Enlarged Display

Playback images can be displayed enlarged (Playback Zoom).

Rotate the rear dial right.

1× → 2× → 4× → 8× → 16×



Button operation	Touch operation	Description of operation
	—	Enlarges/reduces the screen.
—	Pinching out/in	Enlarges/reduces the screen in small steps.
	Dragging	Moves the enlarged area.
	—	Forwards or rewinds the image while maintaining the same zoom magnification and zoom position.

- Each time you touch the screen twice, the display switches between enlarged and normal view.
- Images recorded with [Quality] set to [RAW] can be enlarged up to 8×.

Thumbnail Screen

Rotate the rear dial left.

1 screen → 12 screens → 30 screens → Calendar display

- If the rear dial is rotated to the right, the previous playback screen will be displayed.
- It is possible to switch the playback screen by touching the following icons.
 - : 1 screen
 - : 12 screens
 - : 30 screens
 - : Calendar display
- You can also scroll the list display by dragging the screen up/down.
- Pictures displayed using [] cannot be played back.

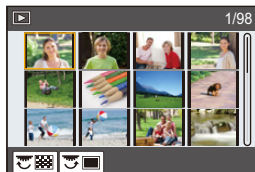

■ To return to Normal Playback

Select the picture, and then press [MENU/SET].

- If you select a motion picture, it will be played back automatically.

Calendar Playback

1 Rotate the rear dial left to display the Calendar display.

2 Press ▲/▼/◀/▶ to select the recording date and press [MENU/SET].

- Only the images recorded on that date will be displayed.
- Rotate the rear dial left to return to the Calendar display.

3 Press ▲/▼/◀/▶ to select a picture and then press [MENU/SET].

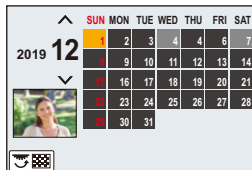

- The recording date of the picture selected in the playback screen becomes the date selected when the Calendar screen is first displayed.
- You can display the Calendar between January 2000 and December 2099.
- If the date is not set in the camera, the recording date is set as the 1st January, 2019.
- If you take pictures after setting the travel destination in [World Time], the pictures are displayed by the dates at the travel destination in Calendar Playback.

Group Images

A picture group consists of multiple pictures. You can play back pictures in a group either continuously or one by one.

- You can edit or delete all pictures in a group at once.
(For example, if you delete a picture group, all pictures in the group are deleted.)



A picture group saved at once with [4K PHOTO Bulk Saving].



A picture group consisting of pictures taken with Focus Bracket.



A picture group consisting of pictures taken in a Time Lapse Shot.



A picture group consisting of pictures taken in the Stop Motion Animation.

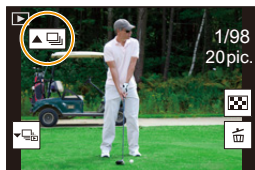

- Pictures will not be grouped if recorded without setting the clock.

■ Playing back group pictures one by one

1 Press ▼.

- The same operation can be performed by touching [], [], [], or [].

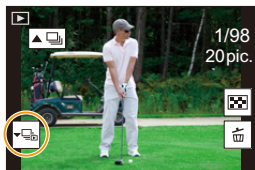

2 Press ◀/▶ to flip through images.

- To return to the normal playback screen, press ▼ again or touch [].
- Each picture in a group can be treated same as normal pictures when they are played back. (Such as thumbnail screen, enlarged display and deleting images)

■ Continuously playing back Group Pictures

Press ▲.

- The same operation can be performed by touching the group picture icon ([▲🖼]), [▲📷], [▲📷📷]).
- When playing back group pictures one at a time, options are displayed. After selecting [Burst Play] (or [Sequential Play]), select either of the following playback methods:



[From the first picture]:



Pictures are played back continuously from the first picture of the group.

[From the current picture]:

Pictures are played back continuously from the picture being played back.

- Operations during continuous playback

Button operation	Touch operation	Description of operation
▲		Continuous playback/Pause
◀		Fast rewind
		Rewind (while pausing)

Button operation	Touch operation	Description of operation
▼		Stop
▶		Fast forward
		Forward (while pausing)

Deleting Images

Once deleted, pictures cannot be recovered.

■ To delete a single picture

- 1 In Playback Mode, select the picture to delete and then press [].

- The same operation can be performed by touching [].

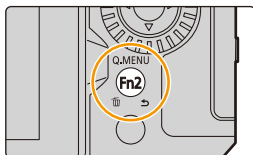

- 2 Press ▲ to select [Delete Single] and then press [MENU/SET].

■ To delete multiple pictures (up to 100) or all the pictures

- Picture groups are treated as a single picture. (All the pictures in the selected picture group will be deleted.)

- 1 In Playback Mode, press [].
- 2 Press ▲/▼ to select [Delete Multi] or [Delete All] and then press [MENU/SET].
 - After selecting [Delete All], if you select [Delete All Non-rating], you can delete all pictures except for those with ratings.

(When [Delete Multi] is selected)

- 3 Press ▲/▼/◀/▶ to select the picture, and then press [MENU/SET] to set. (Repeat this step.)
 - [] appears on the selected pictures.
To cancel the selection, press [MENU/SET] again.
- 4 Press [DISP.] to execute.

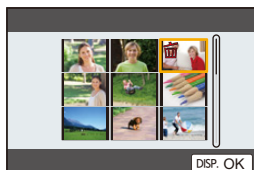

- Depending on the number of pictures to be deleted, it may take some time to delete them.

9.

Menu Guide

Given below is the list of menus. Menu explained in detail on other pages are indicated with page numbers.

- For information about menu operation methods, refer to page 55.
- For information about methods of entering text, refer to page 64.

Menus that are only available for particular Recording Modes

[Rec] menu

 P192

[Motion Picture] menu

 P210

[Custom] menu

 P213

[Setup] menu

 P228

[My Menu] menu

 P238

[Playback] menu

 P239

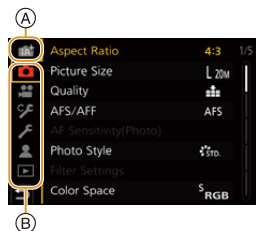

Menus that are only available for particular Recording Modes

: [Intelligent Auto] menu

- [Intelligent Auto Mode] (P66)
- [iHNR] (P68)
- [iHandheld Night Shot] (P68)

: [Creative Video] menu

- [Exposure Mode] (P180)
- [4K Live Cropping] (P182)
- [High Speed Video] (P181)

C : [Custom Mode] menu

You can change the settings registered to custom sets (C2). (P81)

SCN : [Scene Guide] menu

- [Scene Switch] (P82)

🎨 : [Creative Control] menu

- [Filter Effect] (P88)
- [Simultaneous Record w/o Filter] (P88)

📷 [Rec] menu

- [Aspect Ratio] (P194)
- [Picture Size] (P194)
- [Quality] (P195)
- [AFS/AFF] (P95) *
- [AF Sensitivity(Photo)] (P96)
- [Photo Style] (P196) *
- [Filter Settings] (P199) *
- [Color Space] (P200)
- [Metering Mode] (P201) *
- [Highlight Shadow] (P201) *
- [i.Dynamic] (P202) *
- [i.Resolution] (P203) *
- [Flash] (P162)
- [Red-Eye Removal] (P203)
- [ISO Sensitivity (photo)] (P203)
- [Min. Shtr Speed] (P204)
- [Long Shtr NR] (P204)
- [Shading Comp.] (P205)
- [Diffraction Compensation] (P205) *
- [Stabilizer] (P148) *
- [Ex. Tele Conv.] (P154)
- [Digital Zoom] (P156) *
- [Burst Rate] (P119)
- [4K PHOTO] (P122)
- [Self Timer] (P143)
- [Time Lapse/Animation] (P138, 140)
- [Live View Composite] (P76)
- [Panorama Settings] (P85)
- [Silent Mode] (P206)
- [Shutter Type] (P206)
- [Shutter Delay] (P207)
- [Bracket] (P144)
- [HDR] (P208)
- [Multi Exp.] (P209)

* Menu items common to the [Rec] menu and [Motion Picture] menu. Setting changes will be applied to the settings of both menus.

[Aspect Ratio]

Applicable modes:

This allows you to select the aspect ratio of the pictures to suit printing or the playback method.

MENU → **[Rec]** → **[Aspect Ratio]**

[4:3]	[Aspect Ratio] of a 4:3 TV
[3:2]	[Aspect Ratio] of a 35 mm film camera
[16:9]	[Aspect Ratio] of a 16:9 TV
[1:1]	Square aspect ratio

Not available in these cases:

- [Aspect Ratio] cannot be set in the following cases:
 - [Panorama Shot] (Scene Guide Mode)

[Picture Size]

Applicable modes:

The higher the numbers of pixels, the finer the detail of the pictures will appear even when they are printed onto large sheets.

MENU → **[Rec]** → **[Picture Size]**

Aspect ratio	Image size		Aspect ratio	Image size	
[4:3]	[L] (20M)	5184×3888	[16:9]	[L] (14.5M)	5184×2920
	[EXM] (10M)	3712×2784		[EXM] (8M)	3840×2160
	[EXS] (5M)	2624×1968		[EXS] (2M)	1920×1080
[3:2]	[L] (17M)	5184×3456	[1:1]	[L] (14.5M)	3888×3888
	[EXM] (9M)	3712×2480		[EXM] (7.5M)	2784×2784
	[EXS] (4.5M)	2624×1752		[EXS] (3.5M)	1968×1968

- When [Ex. Tele Conv.] ([Rec]) is set, **[EX]** is displayed on the picture sizes of each aspect ratio except for [L].

Not available in these cases:







- [Picture Size] cannot be set in the following cases:
 - [Panorama Shot] (Scene Guide Mode)
 - When recording 4K photos
 - When recording with the Post Focus function

[Quality]

Applicable modes:         

Set the compression rate at which the pictures are to be stored.



MENU →  **[Rec]** → **[Quality]**

Settings	File format	Description of settings
	JPEG	A JPEG image in which image quality was given priority.
		A standard image quality JPEG image. This is useful for increasing the number of shots without changing the number of pixels.
	RAW+JPEG	You can record a RAW image and a JPEG image ( or ) simultaneously.
		
	RAW	You can only record RAW images.



**About RAW**

RAW format refers to a data format of images that have not been processed. Playback and editing of RAW images require the camera or the dedicated software.

- You can process RAW images in [RAW Processing] in the [Playback] menu.
- Use software ("SILKYPIX Developer Studio" by Ichikawa Soft Laboratory) to process and edit RAW files on a PC. (P299)

- RAW images are always recorded in the [4:3] (5184×3888) aspect ratio.
- When you delete an image recorded with  or , both the RAW and JPEG images will be deleted simultaneously.
- When you play back an image recorded with [RAW], grey areas corresponding to the aspect ratio at the time of recording are displayed.
- The setting is fixed to  when recording is performed with the 4K Photo or Post Focus function.

**Not available in these cases:**













- In the following cases, , , and [RAW] cannot be set.
 - [Handheld Night Shot]/[Panorama Shot] (Scene Guide Mode)

[Photo Style]

Applicable modes:   **P** **A** **S** **M**   

You can select effects to match the type of image you wish to record.

MENU →  **[Rec]/**  **[Motion Picture]** → **[Photo Style]**

 STD. [Standard]	This is the standard setting.
 VIVID [Vivid]	Brilliant effect with high saturation and contrast.
 NAT [Natural]	Soft effect with low contrast.
 MONO [Monochrome]	Monochrome effect with no colour shades.
 L.MONO [L.Monochrome]	Black-and-white effect with rich gradation and crisp black accents.
 L.MONO D [L.Monochrome D]	Monochrome effect that creates a dynamic impression with enhanced highlights and shadows.
 SCNY [Scenery]	An effect appropriate for sceneries with vivid blue skies and greens.
 PORT [Portrait]	An effect appropriate for portraits with a healthy and beautiful skin tone.
 CUST [Custom]	Use the setting registered in advance.
 CINED [Cinelike D]	An effect that creates a film-like finishing touch using a gamma curve and gives priority to the dynamic range. • This function is suitable for motion picture editing processes.
 CINEV [Cinelike V]	Gives priority to the contrast by using a gamma curve designed to create film-like images.
 V.LogL [V-Log L]	A gamma curve effect designed for post production editing. • It allows you to add rich gradation to images during post production editing.

- In Intelligent Auto Plus Mode:
 - Only [Standard] or [Monochrome] can be set.
 - The setting will be reset to [Standard] when the camera is switched to another Recording Mode or this unit is turned off.
 - Image quality cannot be adjusted.
- In Scene Guide Mode, you can only set the image quality.

■ Adjusting the picture quality

- 1 Press **◀/▶** to select the type of Photo Style.
- 2 Press **▲/▼** to select the items, and then press **◀/▶** to adjust.

- You can register adjusted details to [Custom] by pressing [DISP].

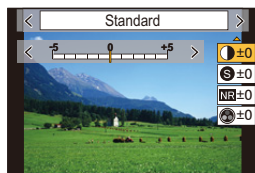

[Contrast] ^{*1}	[+]	Increases the difference between the brightness and the darkness in the picture.
	[-]	Decreases the difference between the brightness and the darkness in the picture.
[Sharpness]	[+]	The picture is sharply defined.
	[-]	The picture is softly focused.
[Noise Reduction]	[+]	The noise reduction effect is enhanced. Picture resolution may deteriorate slightly.
	[-]	The noise reduction effect is reduced. You can obtain pictures with higher resolution.
[Saturation] ^{*1,2}	[+]	The colours in the picture become vivid.
	[-]	The colours in the picture become natural.
[Color Tone] ^{*3}	[+]	Adds a bluish tone.
	[-]	Adds a yellowish tone.
[Filter Effect] ^{*3}	[Yellow]	The blue sky can be recorded clearly.
	[Orange]	The blue sky can be recorded in darker blue.
	[Red]	The blue sky can be recorded in much darker blue.
	[Green]	The skin and lips of people appear in natural tones. Green leaves appear brighter and more enhanced.
	[Off]	—
[Grain Effect] ^{*3}	[Low]/ [Standard]/ [High]	Sets the graininess in a picture.
	[Off]	—
	[Off]	—

*1 It cannot be adjusted when [V-Log L] is set.

*2 Not displayed when [Monochrome], [L.Monochrome] or [L.Monochrome D] is selected.

*3 Displayed only when [Monochrome], [L.Monochrome] or [L.Monochrome D] is selected.

- If you adjust the picture quality, [+] is displayed beside the Photo Style icon on the screen.

- 3 Press **[MENU/SET]**.

- The effect of [Grain Effect] cannot be checked on the recording screen.



Not available in these cases:

- [Grain Effect] is not available in the following cases.
 - [Panorama Shot] (Scene Guide Mode)
 - When recording motion pictures
 - When recording 4K photos
 - When recording with the Post Focus function



MENU



[Filter Settings]





Applicable modes:   **P** **A** **S** **M**   

You can add the image effects (filters) of Creative Control Mode. (P87)

MENU →  **[Rec]**/ **[Motion Picture]** → **[Filter Settings]** → **[Filter Effect]**

Settings: **[ON]/[OFF]/[SET]**

■ Setting a Filter with Touch Operation

- 1 Touch .
- 2 Touch the item you want to set.
 - : Image effect ON/OFF
 - : Selects an image effect (filter)
 - : Adjusts an image effect

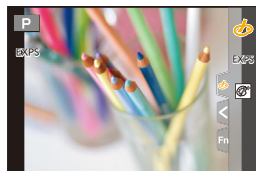

- [Rough Monochrome]/[Silky Monochrome]/[Soft Focus]/[Star Filter]/[Sunshine] are not available in the following cases.
 - Creative Video Mode
 - When recording motion pictures
- The available ISO sensitivity settings will be limited up to [ISO3200].
- The ISO sensitivity for [High Dynamic] will be fixed to [AUTO].
- When using [Filter Effect], you cannot use menus or recording functions not available in Creative Control Mode.
 - For example, White Balance will be fixed to [AWB] and the flash will be set to  (forced flash off).
- The following limitations apply when the Scene Guide Mode is set to [Panorama Shot]:
 - [Toy Effect]/[Toy Pop]/[Miniature Effect]/[Sunshine] are not available.
 - The image effects of [Rough Monochrome]/[Silky Monochrome]/[Soft Focus]/[Star Filter] will not be applied to the screen during recording.
 - When [High Key] is set, its effect may not appear clearly in scenes that are not bright enough.

Not available in these cases:

- In the following case, [Filter Settings] does not work:
 - When the Scene Guide Mode is set to anything other than [Panorama Shot]
 - When [High Speed Video] is set
 - When using [4K Live Cropping]

■ [Simultaneous Record w/o Filter]

You can press the shutter button once and take two pictures simultaneously, one with an image effect and the other one without it.

MENU → [Rec]/ [Motion Picture] → [Filter Settings] → [Simultaneous Record w/o Filter]

Settings: [ON]/[OFF]

- A picture with an image effect will be taken first, followed by a picture without it.
- Only an image with an image effect is displayed for Auto Review.

Not available in these cases:

- In the following case, [Simultaneous Record w/o Filter] does not work:
 - Scene Guide Mode
 - Recording still pictures while recording a motion picture (when set to (Video Priority))
 - When recording 4K photos
 - When recording with the Post Focus function
 - When recording in Burst Mode
 - When [Quality] is set to [RAW_{Hi}], [RAW_{Lo}] or [RAW]
 - When recording with the Bracket function
 - When using [Time Lapse Shot]
 - When using [Stop Motion Animation]

[Color Space]

Applicable modes:

This sets the method for reproducing the correct colours to output the recorded images to a PC screen or a device such as a printer.

MENU → [Rec] → [Color Space]

[sRGB]	Colour space is set to sRGB colour space. This is widely used in computer related equipment.
[AdobeRGB]	Colour space is set to AdobeRGB colour space. AdobeRGB is mainly used for business purposes such as professional printing because it has a greater range of reproducible colours than sRGB.

- Set to [sRGB] if you are not very familiar with AdobeRGB.
- The setting is fixed to [sRGB] in the following cases.
 - When recording motion pictures
 - When recording 4K photos
 - When recording with the Post Focus function
 - When [Photo Style] is set to [V-Log L]

[Metering Mode]

Applicable modes:

Type of optical measurement to measure brightness can be changed.

MENU → **[Rec]/** **[Motion Picture]** → **[Metering Mode]**

	Brightness measurement position	Conditions
(Multiple)	Whole screen	Normal usage (produces balanced pictures)
(Centre weighted)	Centre and surrounding area	Subject in centre
(Spot)	Centre of [+] (spot metering target) 	Great difference between brightness of subject and background (e.g. person in spotlight on stage, backlighting)

- If you set the spot metering target on the edge of the screen, the metering may be affected by the brightness around the location.

**Not available in these cases:**

- In the following case, [Metering Mode] does not work:
 - When the Scene Guide Mode is set to anything other than [Panorama Shot]

[Highlight Shadow]

Applicable modes:

You can adjust the brightness of bright and dark portions on an image while checking the brightness on the screen.

MENU → **[Rec]/** **[Motion Picture]** → **[Highlight Shadow]**

1 Press </> to select the type of Highlight Shadow.

<input checked="" type="checkbox"/> (Standard)	A state with no adjustments is set.
<input checked="" type="checkbox"/> (Raise the contrast)	Bright areas are brightened, and dark areas are darkened.
<input checked="" type="checkbox"/> (Lower the contrast)	Bright areas are darkened, and dark areas are brightened.
<input checked="" type="checkbox"/> (Brighten dark areas)	Dark areas are brightened.
/ / (Custom)	Registered custom settings can be applied.

2 Rotate the front/rear dial to adjust the brightness of bright/dark portions.

- (A) Bright portion
- (B) Dark portion

- Adjustments can also be made by dragging the graph.
- To register a preferred setting, press \blacktriangle , and select the destination where the custom setting will be registered to ([Custom1] (\square)/[Custom2] (\square)/[Custom3] (\square)).

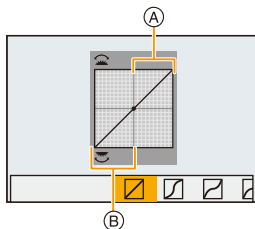

3 Press [MENU/SET].

- The screen display can be switched by pressing [DISP.] on the brightness adjustment screen.

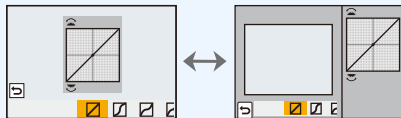

- Turning off this unit will return the setting adjusted with $\square/\square/\square/\square$ back to the default setting.
- When [Photo Style] is set to [V-Log L], the setting is fixed to \square (Standard).

Not available in these cases:

- [Highlight Shadow] cannot be set in the following cases:
 - When using [Filter Settings]

[i.Dynamic]

Applicable modes:

Contrast and exposure are compensated when the brightness difference between the background and subject is great, etc.

MENU → [Rec]/ [Motion Picture] → [i.Dynamic]

Settings: [AUTO]/[HIGH]/[STANDARD]/[LOW]/[OFF]

Not available in these cases:

- Compensation effect may not be achieved depending on the recording conditions.
- [i.Dynamic] does not work in the following cases:
 - When [HDR] is set to [ON]
- [i.Dynamic] is not available in the following cases:
 - [Panorama Shot] (Scene Guide Mode)
 - When [Photo Style] is set to [V-Log L]
 - When recording with Live View Composite

[i.Resolution]

Applicable modes: **P** **A** **S** **M**

Pictures with sharp profile and resolution can be taken by using the Intelligent Resolution Technology.

MENU → **[Rec]** / **[Motion Picture]** → **[i.Resolution]**

Settings: **[HIGH]**/**[STANDARD]**/**[LOW]**/**[OFF]**

[Red-Eye Removal]

Applicable modes: **P** **A** **S** **M**

If you fire the flash when using Red-Eye Reduction (or), the camera automatically detects red-eye and corrects the picture.

MENU → **[Rec]** → **[Red-Eye Removal]**

Settings: **[ON]**/**[OFF]**

- If you set this item to [ON], the icon will change to or .
- Under certain circumstances, red-eye cannot be corrected.

[ISO Sensitivity (photo)]

Applicable modes: **P** **A** **S** **M**

Set the upper and lower limits of the ISO sensitivity when it is set to **[AUTO]** or **[iISO]**.

MENU → **[Rec]** → **[ISO Sensitivity (photo)]**

[ISO Auto Lower Limit Setting]	[200]/[400]/[800]/[1600]/[3200]/[6400]/[12800]
[ISO Auto Upper Limit Setting]	[AUTO]/[400]/[800]/[1600]/[3200]/[6400]/[12800]/[25600]

Not available in these cases:

- **[ISO Sensitivity (photo)]** is not available when the following functions are being used:
 - **[Clear Nightscape]/[Cool Night Sky]/[Warm Glowing Nightscape]/[Handheld Night Shot]** (Scene Guide Mode)

[Min. Shtr Speed]

Applicable modes:   S M   

Set the minimum shutter speed when the ISO sensitivity is set to [AUTO] or [iISO].

MENU →  **[Rec]** → **[Min. Shtr Speed]**

Settings: [AUTO]/[1/16000] to [1/1]

- The shutter speed may become slower than the set value in situations where proper exposure cannot be obtained.

[Long Shtr NR]

Applicable modes:   S M   

The camera automatically removes noise that appears when the shutter speed becomes slower to take pictures of night or similar scenery.

MENU →  **[Rec]** → **[Long Shtr NR]**

Settings: [ON]/[OFF]

- [Long shutter noise reduction ongoing] is displayed for the same time as the shutter speed for signal processing.

 **Not available in these cases:**

- [Long Shtr NR] is not available in the following cases:
 - [Panorama Shot] (Scene Guide Mode)
 - When recording motion pictures
 - When recording 4K photos
 - When recording with the Post Focus function
 - When using the electronic shutter

[Shading Comp.]**Applicable modes:**       

When the screen periphery darkens as a result of the lens characteristics, you can record pictures with the brightness of the screen periphery corrected.

MENU →  **[Rec]** → **[Shading Comp.]****Settings: [ON]/[OFF]**

- Compensation effect may not be achieved depending on the recording conditions.
- Noise in the periphery of the picture may stand out with higher ISO sensitivity.

 **Not available in these cases:**

- Correction is not possible in the following cases:
 - When recording motion pictures
 - When taking pictures while recording motion pictures (when  (Video Priority) is set)
 - When recording 4K photos
 - When recording with the Post Focus function
 - When using [Ex. Tele Conv.] ([Rec])
 - When using the Digital Zoom

[Diffraction Compensation]**Applicable modes:**       

The camera raises the resolution by correcting the blurriness caused by diffraction when the aperture is closed.

MENU →  **[Rec]**/ **[Motion Picture]** → **[Diffraction Compensation]****Settings: [AUTO]/[OFF]**

- Noise may stand out with higher ISO sensitivity.

[Silent Mode]

Applicable modes: **P** **A** **S** **M**

Disables operational sounds and output of light at once.

MENU → **[Rec]** → **[Silent Mode]**

Settings: [ON]/[OFF]

- Audio from the speaker will be muted and the flash and the AF Assist lamp will be disabled. The following settings are fixed.
 - [Flash Mode]: (forced flash off)
 - [Shutter Type]: [ESHTR]
 - [AF Assist Lamp]: [OFF]
 - [Beep Volume]: (OFF)
 - [E-Shutter Vol]: (OFF)
- Even when [ON] is set, the following lamps light up/flash.
 - WIRELESS connection lamp
 - Self-timer indicator
- Sounds that are produced by the camera regardless of your operations, such as the lens aperture sound, cannot be muted.
- **Be sure to pay special attention to the privacy, the likeness rights, etc. of the subject when you use this function. Use at your own risk.**

[Shutter Type]

Applicable modes: **P** **A** **S** **M**

Select the shutter to be used for taking pictures.

MENU → **[Rec]** → **[Shutter Type]**

[AUTO]	Switches the shutter type automatically depending on the recording condition and shutter speed.
[MSHTR]	Takes pictures in Mechanical Shutter Mode.
[EFC]	Takes pictures in Electronic Front Curtain Mode.
[ESHTR]	Takes pictures in Electronic Shutter Mode.

	Mechanical Shutter	Electronic Front Curtain	Electronic Shutter
Description	The camera starts and ends an exposure with the mechanical shutter.	The camera starts an exposure electronically, and ends it with the mechanical shutter.	The camera starts and ends an exposure electronically.
Flash	○	○	—
Shutter Speed (Sec.)	B (Bulb) ^{*1} /60 to 1/4000	B (Bulb) ^{*1} /60 to 1/2000	1 ^{*2} to 1/16000
Shutter Sound	Mechanical shutter sound	Mechanical shutter sound	Electronic shutter sound ^{*3}

*1 This setting is available only in Manual Exposure Mode.

*2 If the ISO sensitivity is higher than [ISO3200], the shutter speed will be faster than 1 second.

*3 The electronic shutter sound can be set in [E-Shutter Vol] and [E-Shutter Tone] in [Beep] of the [Setup] menu.

- Compared to Mechanical Shutter Mode, Electronic Front Curtain Mode produces less shutter-induced shake, so it can minimise the influence of shutter vibration.
- Electronic Shutter Mode allows you to take pictures without causing shutter vibration.

- When [] is displayed on the screen, pictures will be taken with the electronic shutter.
- When [ESHTR] is set, if you take a picture of a moving subject, it may appear distorted in the picture.
- When [ESHTR] is set, horizontal stripes may appear on pictures taken under lighting such as a fluorescent or LED lighting fixture. The horizontal stripes may be reduced if you set a slower shutter speed.

[Shutter Delay]

Applicable modes:   **P** **A** **S** **M**   

To reduce the influence of hand shake or shutter vibration, shutter is released after the specified time has passed.

MENU →  [Rec] → [Shutter Delay]

Settings: [8SEC]/[4SEC]/[2SEC]/[1SEC]/[OFF]

Not available in these cases:

- This function is not available in the following cases:
 - [Panorama Shot] (Scene Guide Mode)
 - When recording motion pictures
 - When recording 4K photos
 - When recording with the Post Focus function
 - When [HDR] is set to [ON]

[HDR]

Applicable modes:   **P** **A** **S** **M**   

You can combine 3 pictures with different levels of exposure into a single picture with rich gradation.

You can minimise the loss of gradations in bright areas and dark areas when, for example, the contrast between the background and the subject is large.

An image combined by HDR is recorded in JPEG.

MENU →  **[Rec]** → **[HDR]**

Settings: **[ON]/[OFF]/[SET]**

■ Changing settings

[Dynamic Range]	<p>[AUTO]: Automatically adjusts the exposure range according to the differences between the bright and dark areas.</p> <p>[±1 EV]/[±2 EV]/[±3 EV]: Adjusts the exposure within the selected exposure parameters.</p>
[Auto Align]	<p>[ON]: Automatically corrects camera shake (jitter) and other problems that can cause the images to misalign. Recommended for use during hand-held shooting.</p> <p>[OFF]: Image misalignment not adjusted. Recommended when a tripod is used.</p>

- Do not move the unit during the continuous shooting after pressing the shutter button.
- You cannot take the next picture until the combination of pictures is complete.
- A moving subject may be recorded with unnatural blurs.
- The angle of view becomes narrow slightly when [Auto Align] is set to [ON].
- Flash is fixed to  (forced flash off).



Not available in these cases:

- [HDR] does not work for the pictures taken during a motion picture recording.
- This function is not available in the following cases:
 - When recording 4K photos
 - When recording with the Post Focus function
 - When recording in Burst Mode
 - When recording with the Bracket function
 - When [Quality] is set to **[RAW₄]**, **[RAW₅]** or **[RAW]**
 - When using [Time Lapse Shot]
 - When using [Stop Motion Animation] (when [Auto Shooting] is set)

[Multi Exp.]

Applicable modes: P A S M

Gives an effect like multi exposure. (up to 4 times equivalent per a single image)

[MENU] → **[Rec]** → **[Multi Exp.]**

1 Press ▲/▼ to select [Start] and then press [MENU/SET].

2 Decide on the composition, and take the first picture.

- After taking the picture, press the shutter button halfway down to take the next picture.
- Press ▲/▼ to select the item and then press [MENU/SET] for one of the following operations.
 - [Next]: Advance to the next picture.
 - [Retake]: Return to the first picture.
 - [Exit]: Record the image of the first picture, and finish the multiple exposure picture-taking session.

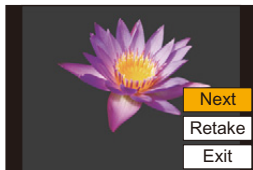

3 Shooting the second, third, and fourth exposures.

- To save the recorded pictures and finish Multiple Exposure, press [Fn2] when taking pictures.

4 Press ▼ to select [Exit] and then press [MENU/SET].

- You can also press the shutter button halfway to finish.



■ Changing settings

[Auto Gain]	If you select [OFF], all exposure results are superimposed as they are. Compensate the exposure as necessary.
[Overlay]	If you select [ON], you can apply Multi Exposure to previously recorded images. After [Start] is selected, images on the card will be displayed. Select a RAW image, and press [MENU/SET] to proceed to recording.

- The recording information displayed for pictures taken with multiple exposures is the recording information for the last picture taken.
- You can perform [Overlay] only for RAW images recorded with the camera.



Not available in these cases:

- This function is not available in the following cases:
 - When using [Time Lapse Shot]
 - When using [Stop Motion Animation]
 - When recording with Live View Composite

[Motion Picture] menu

- [Rec Format] (P171)
- [Rec Quality] (P171)
- [Snap Movie] (P176)
- [AFS/AFF] (P95) *
- [Continuous AF] (P172)
- [AF Custom Setting(Video)] (P173)
- [Photo Style] (P196) *
- [Filter Settings] (P199) *
- [Luminance Level] (P210)
- [Metering Mode] (P201) *
- [Highlight Shadow] (P201) *
- [i.Dynamic] (P202) *
- [i.Resolution] (P203) *
- [ISO Sensitivity (video)] (P181)
- [Diffraction Compensation] (P205) *
- [Stabilizer] (P148) *
- [Flkr Decrease] (P210)
- [Ex. Tele Conv.] (P154)
- [Digital Zoom] (P156) *
- [Picture Mode in Rec.] (P175)
- [Sound Rec Level Disp.] (P179)
- [Sound Rec Level Adj.] (P179)
- [Sound Rec Level Limiter] (P179)
- [Wind Noise Canceller] (P211)/
[Wind Cut] (P310)
- [Lens Noise Cut] (P211)
- [Special Mic.] (P309)
- [Sound Output] (P212)

* Menu items common to the [Rec] menu and [Motion Picture] menu. Setting changes will be applied to the settings of both menus.

[Luminance Level]

Applicable modes:   **P** **A** **S** **M**   

Select the luminance range to match the use of motion picture.

Preparation:

Set [Rec Format] to [MP4].

MENU →  **[Motion Picture]** → **[Luminance Level]**

Settings: [0-255]/[16-255]

- This will be fixed at [16-255] when the [Rec Format] is [AVCHD].
- The setting is fixed at [0-255] in the following cases:
 - When taking pictures (including picture-taking during motion picture recording)
 - When [Photo Style] is set to [V-Log L]

[Flkr Decrease]

Applicable modes:   **P** **A** **S** **M**   

The shutter speed can be fixed to reduce the flicker or striping in the motion picture.

MENU →  **[Motion Picture]** → **[Flkr Decrease]**

Settings: [1/50]/[1/60]/[1/100]/[1/120]/[OFF]

[Wind Noise Canceller]

Applicable modes:   **P** **A** **S** **M**   

This will reduce the wind noise coming into the built-in microphone while maintaining sound quality.

MENU →  **[Motion Picture]** → **[Wind Noise Canceller]**

Settings: **[HIGH]**/**[STANDARD]**/**[OFF]**

- **[HIGH]** effectively reduces the wind noise by minimising the low-pitched sound when a strong wind is detected.
- **[STANDARD]** extracts and reduces only the wind noise without deteriorating the sound quality.
- You may not see the full effect depending on the recording conditions.
- This function works only with the built-in microphone.
When an external microphone is connected, **[Wind Cut]** is displayed.

[Lens Noise Cut]

Applicable modes:   **P** **A** **S** **M**   

This can reduce the power zoom operational sound produced during motion picture recording.

- This function works only when an interchangeable lens that supports power zoom is used.

MENU →  **[Motion Picture]** → **[Lens Noise Cut]**

Settings: **[ON]**/**[OFF]**

- When this function is used, the sound quality may differ from that during normal operation.

[Sound Output]

Applicable modes:   **P** **A** **S** **M**   

You can record motion pictures while hearing the sounds that are being recorded by connecting a commercially available headphones to this unit.

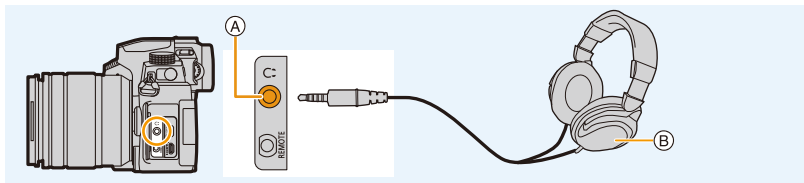

(A) Headphone socket

(B) Commercially available headphone

- Do not use the headphone cables with the length of 3 m (9.8 feet) or more.
- When headphones are connected, electronic sounds and electronic shutter sounds are muted.

Switch the sound output method

MENU →  [Motion Picture] → [Sound Output]



[REALTIME]	Actual sound without time lag. It may be different to the audio recorded in the motion picture.
[REC SOUND]	Sound that is being recorded in motion pictures. The audio may be output slower than the actual audio.

• [Sound Output] is fixed to [REC SOUND] in the following cases:

- When in Recording Mode
- During HDMI output
- When using an external microphone

Adjusting the headphone volume



1 Select the menu.

MENU →  [Custom] →  [Operation] → [Dial Set.] → [Control Dial Assignment] → []

2 Connect headphones, and rotate the control dial while the recording screen is displayed or a motion picture is being played back.

: Reduce volume level

: Increase volume level

- You can also adjust the volume by touching [] or [] during playback.

To adjust the volume using the menu:

MENU →  [Setup] → [Headphone Volume]

[Custom] menu

[Exposure]

- [ISO Increments] (P214)
- [Extended ISO] (P114)
- [Exposure Comp. Reset] (P214)

[Focus / Release Shutter]

- [AF/AE Lock] (P110)
- [AF/AE Lock Hold] (P214)
- [Shutter AF] (P214)
- [Half Press Release] (P214)
- [Quick AF] (P214)
- [Eye Sensor AF] (P215)
- [Pinpoint AF Setting] (P215)
- [AF Assist Lamp] (P215)
- [Direct Focus Area] (P216)
- [Focus/Release Priority] (P216)
- [Focus Switching for Vert / Hor] (P216)
- [Loop Movement Focus Frame] (P216)
- [AF Area Display] (P217)
- [AF+MF] (P217)
- [MF Assist] (P217)
- [MF Assist Display] (P218)

[Operation]

- [Fn Button Set] (P60)
- [WB/ISO/Expo. Button] (P218)
- [ISO Displayed Setting] (P45)
- [Exposure Comp. Disp. Setting] (P46)
- [Q.MENU] (P218)
- [Dial Set.] (P47)
- [Operation Lock Setting] (P218)
- [Focus Ring Lock] (P218)
- [Video Button] (P218)
- [Video Rec. Button (Remote)] (P308)
- [Touch Settings] (P219)

[Monitor / Display]

- [Auto Review] (P219)
- [Monochrome Live View] (P219)
- [Constant Preview] (P220)
- [Live View Boost] (P220)
- [Peaking] (P220)
- [Histogram] (P221)
- [Guide Line] (P221)
- [Center Marker] (P221)
- [Highlight] (P222)
- [Zebra Pattern] (P222)
- [Expo.Meter] (P223)
- [MF Guide] (P223)
- [LVF/Monitor Disp. Set.] (P49)
- [Monitor Info. Disp.] (P223)
- [Rec Area] (P223)
- [Remaining Disp.] (P223)
- [Menu Guide] (P223)

[Lens / Others]

- [Lens Position Resume] (P224)
- [Power Zoom Lens] (P157)
- [Lens Fn Button Setting] (P224)
- [Aperture Ring Increment] (P224)
- [Face Recog.] (P225)
- [Profile Setup] (P227)

MENU →  **[Custom]** →  **[Exposure]**

[ISO Increments]

This changes the increments used to set the ISO sensitivity.

Settings: [1/3 EV]/[1 EV]

[Exposure Comp. Reset]

An exposure value can be reset when the Recording Mode is changed or the camera is turned off.

MENU →  **[Custom]** →  **[Focus / Release Shutter]**

[AF/AE Lock Hold]

When [ON] is selected, focus and exposure stays locked even if you press and release [AF/AE LOCK].

To clear the lock, press [AF/AE LOCK] again.

[Shutter AF]

Set whether or not the focus is adjusted automatically when the shutter button is pressed halfway.

[Half Press Release]

The shutter will immediately fire when the shutter button is pressed halfway.

[Quick AF]

The camera automatically adjusts the focus when the amount of camera blur becomes small.

This will speed up the focusing that takes place when you press the shutter button.

- The battery will be consumed faster than usual.



Not available in these cases:

- This function is not available in the following cases:
 - In Preview Mode
 - In low light situations

[Eye Sensor AF]

The camera automatically adjusts the focus when the eye sensor is active.

- [Eye Sensor AF] may not work in dimly lit conditions.

[Pinpoint AF Setting]

This changes the setting for an enlarged display that appears when the Auto Focus Mode is set to **[+]**.

[Pinpoint AF Time]	Sets the time for which the enlarged screen is displayed when the shutter button is pressed halfway. Settings: [LONG]/[MID]/[SHORT]
[Pinpoint AF Display]	Sets the display mode of the enlarged screen (windowed screen/full screen). Settings: [FULL] (full screen)/[PIP] (windowed screen)

[AF Assist Lamp]

This lights the AF Assist Lamp for easier focusing when you press the shutter button halfway while recording in a dark location.

- The effective range of the AF Assist Lamp is different depending on the lens used.
 - When the interchangeable lens (H-FS12060) is attached and at Wide:
Approx. 1.0 m (3.3 feet) to 3.0 m (9.8 feet)
 - When the interchangeable lens (H-FSA14140) is attached and at Wide:
Approx. 1.0 m (3.3 feet) to 3.0 m (9.8 feet)
 - When the interchangeable lens (H-FS1442A) is attached and at Wide:
Approx. 1.0 m (3.3 feet) to 3.0 m (9.8 feet)
- Remove the lens hood.
- The AF Assist Lamp gets slightly blocked when the interchangeable lens (H-FS12060/H-FSA14140/H-FS1442A) is used, but it does not affect the performance.
- The AF Assist Lamp may be greatly blocked, and it may become harder to focus when a lens with large diameter is used.
- [AF Assist Lamp] is fixed to [OFF] in the following case:
 - [Distinct Scenery]/[Bright Blue Sky]/[Romantic Sunset Glow]/[Vivid Sunset Glow]/[Glistening Water]/[Clear Nightscape]/[Cool Night Sky]/[Warm Glowing Nightscape]/[Artistic Nightscape]/[Handheld Night Shot] (Scene Guide Mode)
 - When [Silent Mode] is set to [ON]

[Direct Focus Area]

This moves the AF area or MF Assist using the cursor button when recording.

- You can move the positions below with the cursor button.
 - When []/[]/[]/[] is selected: AF area
 - When [] is selected: lock-on position
 - When [] is selected: enlarged area
- Use the Quick Menu (P58) or Fn buttons (P60) to use the functions assigned to the cursor button, such as AF Mode selection.
- [Direct Focus Area] is fixed to [OFF] in the following case:
 - [Glistening Water] (Scene Guide Mode)
 - Creative Control Mode
 - When [4K Live Cropping] is set

[Focus/Release Priority]

Set whether to give priority to focus or shutter release during AF.

- Different settings can be applied to different Focus Mode settings ([AFS/AFF], [AFC]).

[FOCUS]	Disables recording when focus is not achieved.
[BALANCE]	Performs recording while controlling the balance between focusing and shutter release timing.
[RELEASE]	Enables recording even when focus is not achieved.

[Focus Switching for Vert / Hor]

Focus positions are stored separately for the camera's horizontal and vertical orientations.

[ON]	<p>Memorises separate positions for horizontal and vertical orientations (two vertical orientations, left and right, are available).</p> <ul style="list-style-type: none"> • The following last-specified positions will be memorised. <ul style="list-style-type: none"> – The last AF area position (when [], [] or [] is used) – The last MF Assist display position 	
[OFF]	Sets the same setting for both horizontal and vertical orientations.	

[Loop Movement Focus Frame]

When setting the AF area position or the MF Assist display position, you can now loop the position from one edge to the other edge of the screen.

[AF Area Display]

This changes the AF area display setting for when the Auto Focus Mode is set to [AF-LOCK] ([49-Area]) or [AF-AREA], etc. ([Custom Multi]).

[ON]	Displays AF areas on the recording screen. • AF areas are not displayed when the default AF area setting is applied to [AF-LOCK] ([49-Area]) or [C1], [C2] or [C3] in [Custom Multi].
[OFF]	Displays AF areas on the recording screen for just a few seconds after you start using them.

- Even when [ON] is set, the same operation as [OFF] is performed in the following cases:
 - When recording motion pictures
 - When recording 4K photos
 - Creative Video Mode

[AF+MF]

You can fine-adjust the focus manually during AF lock (when the following conditions are met).



- When the Focus Mode is set to [AFS] and the shutter button is pressed halfway
- When [AF/AE LOCK] is pressed

[MF Assist]

Sets the display method of MF Assist (enlarged screen).

- Available settings vary depending on the lens used.

When an interchangeable lens having a focus ring (H-FS12060/H-FSA14140/H-FS1442A) is used

	The screen is enlarged by operating the lens or by pressing [MF ASSIST] (◀).
	The screen is enlarged by operating the lens.
	The screen is enlarged by pressing [MF ASSIST] (◀).
[OFF]	The screen is not enlarged.

When an interchangeable lens with no focus ring is used

Settings: [ON]/[OFF]

**Not available in these cases:**

- MF Assist is not displayed in the following cases:
 - When recording motion pictures
 - When recording with [4K Pre-Burst]
 - When using the Digital Zoom

[MF Assist Display]

Sets the display method of MF Assist (enlarged screen).

Settings: **[FULL]** (full screen)/**[PIP]** (windowed screen)

MENU →  **[Custom]** →  **[Operation]**

[WB/ISO/Expo. Button]

This sets the operation to be performed when **[WB]** (White Balance), **[ISO]** (ISO sensitivity) or **[**] (Exposure Compensation) is pressed.

[WHILE PRESSING]	Allows you to change the setting while pressing and holding the button. Release the button to confirm the settings value, and to return to the recording screen.
[AFTER PRESSING]	Press the button to change settings. Press the button again to confirm the settings value, and to return to the recording screen.

[Q.MENU]

If you select **[CUSTOM]**, you can customise the Quick Menu settings. (P59)

[Operation Lock Setting]

This sets which control functions will be disabled when **[Operation Lock]** is set in **[Fn Button Set]** (P60) of the **[Custom]** (**[Operation]**) menu.

[Cursor]	Disables the functions of the cursor button and the [MENU/SET] button.
[Touch Screen]	Disables the touch functions of the touch panel.
[Dial]	Disables the functions of the control dial.

[Focus Ring Lock]

This disables the focus ring operation of the interchangeable lens during MF to lock the focus.

- **[MFL]** is displayed on the recording screen while the focus ring is locked.

[Video Button]

Enables/disables the motion picture button.

[Touch Settings]

Enables/disables the Touch operation.

[Touch Screen]	All touch operations.
[Touch Tab]	Operations of tabs, such as [⏏] on the right side of the screen.
[Touch AF]	[AF] : Operation to optimise focus for a touched subject. (P102) [AF+AE] : Operation to optimise focus and brightness. (P106)
[Touch Pad AF]	Operation to move the AF area by touching the monitor when the viewfinder is in use. (P105)

MENU → ⚙ [Custom] → 📺 [Monitor / Display]

[Auto Review]

Displays a picture immediately after it is taken.

[Duration Time (photo)]	Sets the display time of the recorded images after picture-taking.
[Duration Time (4K PHOTO)]	Sets whether to display/hide the recorded images after 4K photo recording.
[Duration Time (Post Focus)]	Sets whether to display/hide the recorded images after recording with the Post Focus function.
[Playback Operation Priority]	Allows you to change or delete the playback image during Auto Review.

- When [Duration Time (photo)] is set to [HOLD], the images are displayed until the shutter button is pressed halfway. [Playback Operation Priority] will be fixed to [ON].
- When [Grain Effect] is selected for [Photo Style], [Auto Review] is not displayed during [Time Lapse Shot] and [Stop Motion Animation] recording.

[Monochrome Live View]

You can display the recording screen in black and white.
This is convenient for focusing with MF.

- Even if you use the HDMI output during recording, this function will not work for the connected device.
- Recorded images will not be affected.

[Constant Preview]

You can check the effects of the chosen aperture and shutter speed on the recording screen in Manual Exposure Mode.

Preview also operates in the MF Assist screen when [Preview While MF Assist] is set to [ON] in [SET].

- This function does not work when using the flash.

[Live View Boost]

Displays the screen brighter to make it easier to check subjects and compositions even in low-light environment.

[MODE1]	Setting for low brightness, with priority given to a soft display.
[MODE2]	Setting for high brightness, with priority given to image visibility.

- You can change the Recording Mode in which [Live View Boost] works by using [SET].
- This mode does not affect recorded images.
- Noise may be more noticeable in the screen than in the recorded image.

**Not available in these cases:**





- [Live View Boost] does not work in the following cases:
 - When adjusting the exposure (when the shutter button is pressed halfway, for example)
 - When recording a motion picture or 4K photo
 - When using [Filter Settings]
 - When using [Constant Preview]

[Peaking]

In-focus portions (portions on the screen with clear outlines) are highlighted when focus is being adjusted manually.

- When [Detect Level] in [SET] is set to [HIGH], portions to be highlighted are reduced, allowing you to achieve a more precise focus.
- Changing the [Detect Level] setting also changes the [Display Color] setting as follows.

[Detect Level]	[HIGH]	↔	[LOW]
[Display Color]	[] (Light blue)		[] (Blue)
	[] (Yellow)		[] (Orange)
	[] (Yellow-green)		[] (Green)
	[] (Pink)		[] (Red)
	[] (White)		[] (Grey)





- Each time [] in [] is touched, the setting is switched in order of [] ([Detect Level]: [LOW]) → [] ([Detect Level]: [HIGH]) → [OFF].

Not available in these cases:

- [Peaking] is not available for [Rough Monochrome] of Creative Video Mode.
- When [Live View Boost] is being used, [Peaking] is not available.

[Histogram]

Display the histogram.

You can set the position by pressing ///.

- Direct touch operation is also possible from the recording screen.
- A histogram is a graph that displays brightness along the horizontal axis (black to white) and the number of pixels at each brightness level on the vertical axis. It allows you to easily check a picture's exposure.

- (A) dark
- (B) bright

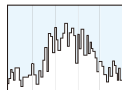





- **When the recorded picture and the histogram do not match each other under the following conditions, the histogram is displayed in orange.**

- During Exposure Compensation
- When the flash is activated
- When the correct exposure is not achieved, such as when the lighting is low.

- The histogram is an approximation in the Recording Mode.

[Guide Line]

This will set the pattern of guide lines displayed when taking a picture.

When [] is set, guideline positions can be set by pressing ///.

- You can also set the position directly by touching [] on the guideline of the recording screen.

Not available in these cases:

- The guide lines are not displayed in [Panorama Shot] in Scene Guide Mode.

[Center Marker]

The centre of the recording screen will be displayed as [].

[Highlight]

When the Auto Review function is activated or when playing back, white saturated areas appear blinking in black and white.



- If there are any white saturated areas, we recommend compensating the exposure towards negative referring to the histogram and then taking the picture again.
- This does not affect the recorded images.

**Not available in these cases:**

- The highlight display does not work in the following cases:
 - During 4K photo playback
 - During playback of images recorded with the Post Focus function
 - When thumbnails are displayed
 - During Calendar Playback
 - When the display is enlarged

[Zebra Pattern]

Indicates parts that may become white saturated through overexposure in a zebra pattern.

[ZEBRA1]**[ZEBRA2]**

Select [SET] to set the brightness to be processed as a zebra pattern.

- You can select a brightness value between [50%] and [105%]. In [Zebra 2], you can select [OFF]. If you select [100%] or [105%], only the areas that are already white saturated are displayed in a zebra pattern. The smaller the value is, the wider the brightness range to be processed as a zebra pattern will be.
- If there are any white saturated areas, we recommend compensating the exposure towards negative referring to the histogram and then taking the picture.
- Displayed zebra patterns will not be recorded.
- If you assign [Zebra Pattern] to [Fn Button Set] in the [Custom] ([Operation]) menu, each time you press the Fn button to which the setting is assigned, the zebra pattern toggles as follows: [Zebra 1] → [Zebra 2] → [OFF].
If you set [Zebra 2] to [OFF], the pattern toggles in the order of [Zebra 1] → [OFF]

[Expo.Meter]

Display the exposure metre.

- Set to [ON] to display the Exposure metre when performing Programme Shift, setting aperture, and setting shutter speed.
- Unsuitable areas of the range are displayed in red.
- When the Exposure metre is not displayed, switch the display information for screen by pressing [DISP].
- If no operations are performed for approximately 4 seconds, the Exposure metre disappears.

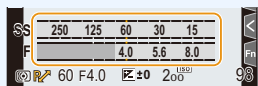
**[MF Guide]**

When you set the focus manually, an MF guide that allows you to check the direction to achieve focus is displayed.

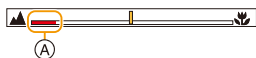

- (A) Indicator for ∞ (infinity)

**[Monitor Info. Disp.]**

Display the recording information screen. (P49, 314)

[Rec Area]



This changes the angle of view during motion picture recording and still picture recording.

	Displays the recording area according to the angle of view for still picture recording.
	Displays the recording area according to the angle of view for motion picture recording.

- The recording area indicated is an approximation.
- When recording with the 4K Photo function or Post Focus function, [Rec Area] is fixed to [📷].



[Remaining Disp.]

This will switch display between the number of recordable pictures and available recording time.

	Displays the number of recordable pictures.
	Displays the available recording time for motion pictures.

[Menu Guide]

This displays a selection screen when you set the mode dial to [SCN] or [📷].

MENU →  **[Custom]** →  **[Lens / Others]**

[Lens Position Resume]

Saves the focus position when you turn off the camera. When an interchangeable lens that is compatible with power zoom is in use, the zoom position is also saved.

[Lens Fn Button Setting]

When an interchangeable lens with a focus selector switch and a focus button is being used, this sets the function to be assigned to the focus button of that lens.

- You can call up the set function by setting the focus selector switch of the lens to [Fn] and then pressing the focus button of the lens.

Settings: **[Focus Stop]/[AF/AE LOCK]/[AF-ON]/[Stabilizer]/[Focus Area Set]/[AF Mode/MF]/[Preview]/[Focus Ring Lock]/[Off]/[Restore to Default]**

- When [Focus Stop] is used, the focus is locked while the focus button is pressed and held.

[Aperture Ring Increment]

The aperture value setting increments for operating the aperture ring can be changed.

- This can be used when using interchangeable lenses that support clickless aperture rings (H-X1025/H-X2550: optional). (As of April 2022)
- This works when the interchangeable lens aperture ring position is set to other than [A] during recording of picture.

[SMOOTH]	Allows fine setting of aperture values.
[1/3EV]	Allows setting of aperture values in 1/3 EV increments.

- If the aperture ring position is set to [A], then this enables the camera aperture value, and is the same setting as with [1/3EV].
- When recording motion pictures, this uses the same fine setting as with [SMOOTH].
- When set to [SMOOTH], fractions of aperture values are not displayed on the screen.

[Face Recog.]

Face Recognition is a function which finds a face resembling a registered face and priorities focus and exposure automatically. Even if the person is located towards the back or on the end of a line in a group photo, the camera can still take a clear picture.

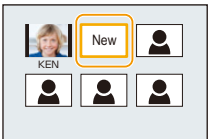
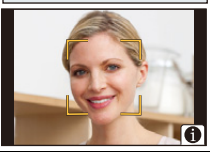
[ON]	Enables the Face Recognition function.		
[OFF]	Disables the Face Recognition function.		
[MEMORY]	Allows you to register face images, or edit or delete registered information.		
	Face Settings		
	You can register information such as names and birthdays for face images of up to 6 people.		
	<ol style="list-style-type: none"> Press ▲/▼/◀/▶ to select the Face Recognition frame that is not registered, and then press [MENU/SET]. 		
	<ol style="list-style-type: none"> Take the picture adjusting the face with the guide. <ul style="list-style-type: none"> The faces of subjects other than people (pets, etc.) cannot be registered. To display the description of the face registration, press ▶ or touch [i]. 		
	<ol style="list-style-type: none"> Set the item. <ul style="list-style-type: none"> You can register up to 3 face images. 		
	[Name]	It is possible to register names. <ul style="list-style-type: none"> For information on how to enter characters, refer to P64. 	
	[Age]	It is possible to register the birthday.	
	[Add Images]	(Add Images)	To add additional face images. <ul style="list-style-type: none"> Select a blank face image frame to register a new image.
		(Delete)	To delete one of the face images. <ul style="list-style-type: none"> Select the face image you want to delete.
Change or delete the information for a registered person			
<ol style="list-style-type: none"> Press ▲/▼/◀/▶ to select the face image to edit or delete and then press [MENU/SET]. 			
<ol style="list-style-type: none"> Set the item. 			
[Info Edit]	Changing the information of an already registered person. <ul style="list-style-type: none"> Perform step ③ in "Face Settings". 		
[Priority]	The focus and exposure are preferentially adjusted for higher-priority faces. <ul style="list-style-type: none"> Rearrange and set the face priority. 		
[Delete]	Deleting information of a registered person.		

Point of recording when registering the face images

- Face front with eyes open and mouth closed, making sure the outline of the face, the eyes, or the eyebrows are not covered with hair when registering.
- Make sure there is no extreme shading on the face when registering.
(Flash will not flash during registration.)

(Good example for registering)

**When face is not recognised during recording**

- Register the face of same person indoors and outdoors, or with different expressions or angles.
- Additionally register at the location of recording.
- When a person who is registered is not recognised, correct by re-registering.
- Face Recognition may not be possible or may not recognise faces correctly even for registered faces, depending on the facial expression and environment.

• The following functions will also work with the Face Recognition function.**In Recording Mode**

- Display of corresponding name when camera detects a registered face*

In Playback Mode

- Display of name and age

- * Names of up to 3 people are displayed.

Precedence for the names displayed when taking pictures is determined according to the order of registration.

• [Face Recog.] only works when the AF Mode is set to [☺].

- During the Burst Mode, [Face Recog.] picture information can be attached to only the first picture.
- When group pictures are played back, the name of the first picture of the set is displayed.

**Not available in these cases:**

- [Face Recog.] does not work in the following cases.
 - When recording motion pictures
- [Face Recog.] cannot be set in the following cases:
 - [Panorama Shot] (Scene Guide Mode)
 - [Miniature Effect] (Creative Control Mode)
 - When recording 4K photos
 - When recording with the Post Focus function
 - When using [Time Lapse Shot]

[Profile Setup]

If you set the name and birthday of your baby or pet in advance, you can record their name and age in months and years in the images.

You can display these at playback or stamp the recorded images using [Text Stamp].

Settings: [] ([Baby1])/[] ([Baby2])/[] ([Pet])/[OFF]/[SET]

■ Setting [Age] or [Name]

- 1 Press ▲/▼ to select [SET] and then press [MENU/SET].
- 2 Press ▲/▼ to select [Baby1], [Baby2] or [Pet] and then press [MENU/SET].
- 3 Press ▲/▼ to select [Age] or [Name] and then press [MENU/SET].
- 4 Press ▲/▼ to select [SET] and then press [MENU/SET].

Enter [Age] (birthday).

Enter [Name].

- For information on how to enter characters, refer to P64.

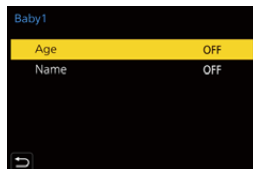

■ To cancel the display of [Age] and [Name]

Select [OFF] in [Profile Setup].

- You can print out ages and names with “PHOTOfunSTUDIO”.



Not available in these cases:

- [Profile Setup] is not available in the following cases:
 - In Creative Video Mode
 - When recording 4K photos
 - When recording with the Post Focus function
- Ages and names are not recorded in the following cases:
 - When recording motion pictures
 - Still pictures recorded during motion picture recording ([] (Video Priority))

[Setup] menu

- [Cust.Set Mem.] (P80)
- [Clock Set] (P39)
- [World Time] (P228)
- [Travel Date] (P229)
- [Wi-Fi] (P230)
- [Bluetooth] (P230)
- [Wireless Connection Lamp] (P230)
- [Beep] (P230)
- [Headphone Volume] (P212)
- [Economy] (P231)
- [Monitor Display Speed] (P232)
- [Monitor Display]/[Viewfinder] (P232)
- [Monitor Luminance] (P232)
- [Eye Sensor] (P233)
- [Battery Use Priority] (P308)
- [USB Mode] (P233)
- [USB Power Supply] (P233)
- [TV Connection] (P234)
- [Language] (P234)
- [Version Disp.] (P234)
- [Folder / File Settings] (P235)
- [No.Reset] (P236)
- [Reset] (P236)
- [Reset Network Settings] (P237)
- [Pixel Refresh] (P237)
- [Sensor Cleaning] (P237)
- [Level Gauge Adjust.] (P237)
- [Demo Mode] (P237)
- [Format] (P33)

MENU →  [Setup]

[World Time]

Sets the times for the region where you live and your holiday destination.

- [Destination] can be set after setting up [Home].

After selecting [Destination] or [Home], press ◀/▶ to select an area, and press [MENU/SET] to set.

[Destination]:

Travel destination area

- (A) Current time of the destination area
- (B) Time difference from home area

[Home]:

Your home area

- (C) Current time
- (D) Time difference from GMT (Greenwich Mean Time)

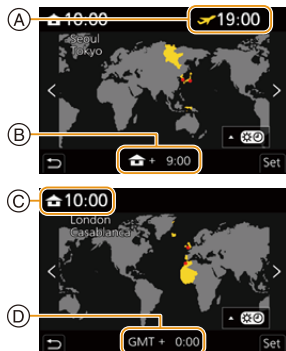

- If you are using Daylight Savings [, press ▲. (The time will move forward by 1 hour.) To return to the normal time, press ▲ again.
- Set to [Home] when you have returned from your travel destination.
- If you cannot find the travel destination in the areas displayed on the screen, set by the time difference from the home area.

[Travel Date]

[Travel Setup]	If you set your travel schedule and record images, elapsed days (how many days after) of the travel will be recorded.
[Location]	When [Travel Setup] is set, you can set your travel destination. • For information on how to enter characters, refer to P64 .

- You can display the elapsed days and travel destination during playback or stamp them on recorded pictures in [Text Stamp].
- The elapsed days and travel destination can be printed out using the software “PHOTOfunSTUDIO”.
- The travel date is calculated using the date in the clock setting and the departure date you set. If you set [World Time] to the travel destination, the travel date is calculated using the date in the clock setting and the travel destination setting.
- When [Travel Setup] is set to [OFF], the number of days elapsed is not recorded. It is not displayed even if [Travel Setup] is set to [SET] after recording.
- When the current date passes the return date, [Travel Setup] is automatically cancelled.
- [Travel Date] cannot be recorded for AVCHD motion pictures.
- [Location] cannot be recorded in the following cases:
 - When recording motion pictures
 - When recording 4K photos
 - When recording with the Post Focus function

[Wi-Fi]■ **[Wi-Fi Function] (P256)**■ **[Wi-Fi Setup] (P291)****[Bluetooth]**■ **[Bluetooth] (P260)**■ **[Remote Wakeup] (P266)**■ **[Returning from Sleep Mode] (P269)**■ **[Auto Transfer] (P271)**■ **[Location Logging] (P273)**■ **[Auto Clock Set] (P274)**■ **[Wi-Fi network settings]**

Registers the Wi-Fi access point. (P286)

Wireless access points used to connect the camera to Wi-Fi networks will be registered automatically.

- Up to 17 wireless access points can be registered. If you try to register more than 17 access points, the oldest registered access points will be deleted.
- Performing [Reset Network Settings] will delete registered wireless access points.

[Wireless Connection Lamp]

This enables/disables the WIRELESS connection lamp.

If you select [OFF], they will not light/flash.

[Beep]

This allows you to set the electronic sound and the electronic shutter sound.

Settings: [Beep Volume]/[E-Shutter Vol]/[E-Shutter Tone]**Not available in these cases:**

- [Beep] is not available when [Silent Mode] is set to [ON].

[Economy]

This is a function to automatically turn the camera to sleep (power save) status or turn off the viewfinder/monitor if no operation is performed for a set time. Reduces battery consumption.

[Sleep Mode]	Sets the amount of time until the camera is put into sleep.	
[Sleep Mode(Wi-Fi)]	Sets the camera to sleep 15 minutes after being disconnected from Wi-Fi.	
[Auto LVF/Monitor Off]	Sets the amount of time it takes for the viewfinder/monitor to turn off. (The camera is not turned off.)	
[Power Save LVF Shooting]	Puts the camera into sleep when the recording screen is displayed using automatic viewfinder/monitor switching. • [Power Save LVF Shooting] does not operate when [Time] is set to [OFF].	
	[Time]	Sets the amount of time until the camera is put into sleep.
	[Display]	Sets the screen where the camera is put to sleep. [Only Monitor Info.]: Puts the camera into sleep only when the on-monitor recording information screen is displayed. (P49) [All Live View]: Puts the camera into sleep from any screen during recording standby.

- To recover from [Sleep Mode], [Sleep Mode(Wi-Fi)], or [Power Save LVF Shooting], perform one of the following operations:
 - Press the shutter button halfway.
 - Set the camera on/off switch to [OFF] and then [ON] again.
- To recover from [Auto LVF/Monitor Off], press one of the buttons.
- When using the AC Adaptor (optional) and the DC Coupler (optional):
 - [Sleep Mode], [Sleep Mode(Wi-Fi)] and [Power Save LVF Shooting] do not operate.
 - [Auto LVF/Monitor Off] is fixed to [5MIN.].

 **Not available in these cases:**

- [Economy] does not work in the following cases.
 - When connecting to a PC or a printer
 - When recording or playing back motion pictures
 - During a slide show
 - When recording with [4K Pre-Burst]
 - When recording in [Multi Exp.]
 - When using [Time Lapse Shot]
 - When using [Stop Motion Animation] (when [Auto Shooting] is set)
 - When recording with Live View Composite
 - When using the HDMI output during recording

[Monitor Display Speed]

This sets the monitor frame rate.

[30fps]	Reduces the power consumption, extending the operating time.
[60fps]	Displays movements smoother.

- The settings of [Monitor Display Speed] do not affect the recorded images.
- The setting for the viewfinder is fixed at [60fps].

[Monitor Display]/[Viewfinder]

Brightness, colour, or red or blue tint of the monitor/viewfinder is adjusted.

- 1 Select the settings by pressing ▲/▼, and adjust with ◀/▶.**
- 2 Press [MENU/SET] to set.**

- It will adjust the monitor when the monitor is in use, and the viewfinder when the viewfinder is in use.
- Some subjects may appear differently from actuality on the monitor. However, this does not affect the recorded pictures.

[Monitor Luminance]

[A* (Auto)]	During recording, this automatically adjusts the brightness depending on how bright it is around the camera. During playback, it adjusts the brightness to the level of the last recording. (If recording has never been performed since the camera was turned on, the brightness will be set to the standard level.)
[1* (Mode1)]	Make the monitor brighter.
[2* (Mode2)]	Make the monitor darker.

- Some subjects may appear differently from actuality on the monitor. However, this does not affect the recorded pictures.
- When [A*] or [1*] is set, the usage time is reduced.

[Eye Sensor]

[Sensitivity]	This will set the sensitivity of the eye sensor.
----------------------	--

[LVF/Monitor Switch]	<p>This will set the method for switching between the monitor and viewfinder. [LVF/MON AUTO] (automatic switching between the monitor and viewfinder) [LVF] (viewfinder) [MON] (monitor)</p> <ul style="list-style-type: none"> • If you press [LVF] to switch the display, the [LVF/Monitor Switch] setting will also switch.
-----------------------------	---

[USB Mode]

Sets the communication method when connecting using the USB connection cable (supplied).

 [Select on connection]	Select this setting to select the USB communication system when connecting to another device.
---	---

 [PC(Storage)]	Select this setting to export images to a connected PC.
--	---

 [PictBridge(PTP)]	Select this setting when connecting to a printer supporting PictBridge.
--	---

[USB Power Supply]

Supplies power via the USB connection cable when the camera is connected to a PC.

- Even if this item is set to [OFF], power will be supplied when the AC adaptor (supplied) is connected.

[TV Connection]**[HDMI Mode (Play)]:**

This sets the video format to be used for output in Playback Mode when the camera and a TV or monitor is connected with an HDMI micro cable.

[AUTO]	Outputs images at an output resolution suited to the connected TV.
[4K/25p]/[1080p]/[1080i]/[720p]/[576p]	Outputs images at the selected resolution. <ul style="list-style-type: none"> • Even when [4K/25p] is set, MP4 motion pictures recorded with [4K/100M/30p] will be output at a resolution of [4K/30p]. • Even when [576p] is set, depending on the connected TV, images will be output at a resolution of [480p].

- If no image appears on your TV when [AUTO] is set, switch to a setting other than [AUTO] that can display images on the TV. (Please read the operating instructions for the TV.)

[HDMI Info Display (Rec)]:

Select whether or not to output the information display of the camera to an external device connected via HDMI. (P295)

[VIERA Link]:

If you select [ON], operations of the camera and the VIERA Link compatible equipment connected to the camera with an HDMI micro cable are automatically linked, enabling you to control the camera with the remote control of the VIERA Link compatible equipment.

[Language]

Set the language displayed on the screen.

- If you set a different language by mistake, select [00] from the menu icons to set the desired language.

[Version Disp.]

This enables the firmware versions of the camera and lens to be checked.

- To display information about the software on the unit, press [MENU/SET] on the version display screen.

[Folder / File Settings]

Set the folder and file name patterns in which images are to be saved.

Folder name		File name	
100ABCDE 		PABC0001.JPG 	
1	Folder number (3-digits, 100–999)	1	Colour space ([P]: sRGB, [_]: AdobeRGB)
2	5-digit user-defined segment	2	3-digit user-defined segment
		3	File number (4-digits, 0001–9999)
		4	File extension

[Select Folder]	Specifies the folder to which images are to be saved. • The folder name is indicated with the number of files that can be stored.	
[Create a New Folder]	[OK]	Creates a new folder with the same 5-digit user-defined segment as the current folder name setting.
	[Change]	Allows you to redefine the 5-digit user-defined segment before creating a new folder. • Available characters: alphabet (upper case characters), numbers, and [_] • For information on how to enter characters, refer to P64 . • A new folder with an incremented folder number is created. • If there are no recordable folders in the card, a screen for resetting the folder number is displayed.
[File Name Setting]	[Folder Number Link]	Uses the folder number of the folder name as the file name's 3-digit user-defined segment.
	[User Setting]	Allows you to define and set the 3-digit user-defined segment of the file name. • Available characters: alphabet (upper case characters), numbers, and [_] • For information on how to enter characters, refer to P64 .

- Each folder can store up to 1000 files.
- File numbers are assigned sequentially from 0001 to 9999 in the order of recording. If you change the storage folder, a continuing number from the last file number will be assigned.
- In the following cases, a new folder with an incremented folder number will be created automatically when the next file is saved:
 - The current folder contains 1000 files
 - The current folder contains a file with the file number “9999”
- New folders cannot be created when there are folders numbered from 100 all the way up to 999. In this case, we recommend saving their data to a computer or similar device and formatting the card.

[No.Reset]

Reset the file number of the next recording to 0001.

- When recording is performed after resetting this item, the folder number is updated and the file number starts from 0001.
- A folder number between 100 and 999 can be assigned.
The folder number should be reset before it reaches 999. We recommend formatting the card after saving the data on a PC or elsewhere.
- To reset the folder number to 100:
 - 1 Perform [Format] to format the card.
 - 2 Perform [No.Reset] to reset the file number.
 - 3 Select [Yes] on the folder number reset screen.

[Reset]

The following settings are reset to the default:

- Recording settings
- Setup settings ([Wi-Fi Setup] and [Bluetooth] settings)
- Custom settings ([Face Recog.] and [Profile Setup] settings)
- Setup/custom settings (except for [Wi-Fi Setup], [Bluetooth], [Face Recog.] and [Profile Setup])
- When the setup/custom settings are reset, the following settings are also reset.
 - The [World Time] setting
 - The settings of [Travel Date] (departure date, return date, location)
 - The settings of [Rotate Disp.], [Picture Sort] and [Delete Confirmation] in the [Playback] menu
- Folder numbers and clock settings are not reset.
- When requesting a repair or transferring/disposing of the camera, refer to “About the personal information” on [P334](#).

[Reset Network Settings]

The following network settings are reset to the default:

- [Wi-Fi Setup]
- Registered device information in [Bluetooth] and values in [Wi-Fi network settings]

- When requesting a repair or transferring/disposing of the camera, refer to “About the personal information” on [P334](#).

[Pixel Refresh]

It will perform optimisation of imaging device and image processing.

- Imaging device and image processing is optimised when the camera is purchased. Use this function when bright spots that do not exist in the subject get recorded.
- Turn the camera off and on after the pixels are corrected.

[Sensor Cleaning]

Dust reduction to blow off the debris and dust that have affixed to the front of the imaging device is performed.

- The dust reduction function will operate automatically if you set the camera on/off switch to [ON]. Use this function if the dust is particularly noticeable.

[Level Gauge Adjust.]

[Adjust.]	Hold the camera in a horizontal position, and press [MENU/SET]. The level gauge will be adjusted.
[Level Gauge Value Reset]	Restores the default level gauge setting.

[Demo Mode]

You can try Post Focus operations, such as focusing and Peaking, with the image picture.



[My Menu] menu

[My Menu Setting]

Register frequently-used menus and display them in [My Menu]. You can register up to 23 menus.

MENU →  **[My Menu]** → **[My Menu Setting]**

[Add]	Specifies the menu to be displayed in My Menu to register it.
[Sorting]	Rearranges the menus displayed in My Menu. Select the menu you want to move and set the destination.
[Delete]	Deletes registered menus. [Delete Item]: Deletes selected menus. [Delete All]: Deletes all of the menus.
[Display from My Menu]	Sets the first menu to be displayed when the menu screen is displayed. [ON]: Displays My Menu. [OFF]: Displays the last-used menu.

[Playback] menu

- [Slide Show] (P240)
- [Playback Mode] (P241)
- [Protect] (P242)
- [Rating] (P242)
- [Title Edit] (P243)
- [Face Rec Edit] (P243)
- [RAW Processing] (P244)
- [4K PHOTO Bulk Saving] (P128)
- [Light Composition] (P247)
- [Sequence Composition] (P248)
- [Clear Retouch] (P249)
- [Text Stamp] (P250)
- [Resize] (P251)
- [Cropping] (P252)
- [Rotate] (P253)
- [Video Divide] (P253)
- [Time Lapse Video] (P254)
- [Stop Motion Video] (P254)
- [Rotate Disp.] (P254)
- [Picture Sort] (P255)
- [Delete Confirmation] (P255)

• The camera may not play back images recorded on other devices correctly, and the functions of the camera may not be available for the images.

■ How to select an image(s) after selecting [Single] or [Multi]

- When [Single] and [Multi] are not available, select an image in the same way as when [Single] is selected.

[Single] setting

- 1 Press **◀/▶** to select the picture.
- 2 Press **[MENU/SET]**.
 - If [Set/Cancel] is displayed at the right bottom of the screen, the setting is cancelled when [MENU/SET] is pressed again.



[Multi] setting

When a screen similar to the one on the right is displayed:

- 1 Press **▲/▼/◀/▶** to select the picture and then press **[MENU/SET]** (repeat).
 - The setting is cancelled when [MENU/SET] is pressed again.
- 2 Press **[DISP.]** to execute.



When a screen similar to the one on the right is displayed:

- Press **▲/▼/◀/▶** to select the picture, and then press **[MENU/SET]** to set (repeat).
- The setting is cancelled when [MENU/SET] is pressed again.

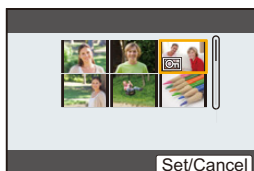

[Slide Show]

You can play back the pictures you have taken in synchronisation with music, and you can do this in sequence while leaving a fixed interval between each of the pictures.





You can also put together a slide show composed of only still pictures, only motion pictures, etc.





We recommend this feature when you view your pictures by connecting the camera to a TV.

MENU →  **[Playback]** → **[Slide Show]**

- Select the group to play back by pressing ▲/▼, and then press [MENU/SET].**
 - If you select [Picture Only], 4K burst files and images recorded with the Post Focus function will also be played back.
 - For images recorded with the Post Focus function, only an in-focus representative image will be chosen and played back.
- Press ▲/▼ to select [Start] and then press [MENU/SET].**

■ Operations during a slide show

Button operation	Touch operation	Description of operation
▲		Play/Pause
◀		Back to previous picture
		Reduce volume level

Button operation	Touch operation	Description of operation
▼		Exit slide show
▶		Ahead to next picture
		Increase volume level

■ Changing the slide show settings

You can change the settings for slide show playback by selecting [Effect] or [Setup] on the slide show menu screen.

[Effect]	This allows you to select the screen effects when switching from one picture to the next.	
[Setup]	[Duration]	• [Duration] can be set only when [OFF] has been selected as the [Effect] setting.
	[Repeat]	[ON]/[OFF]
	[Sound]	<p>[AUTO]: Music is played when the still pictures are played back, and audio is played when the motion pictures are played back.</p> <p>[Music]: Music is played back.</p> <p>[Audio]: Audio of motion pictures is played back.</p> <p>[OFF]: There will be no sound.</p>

Not available in these cases:

- The [Effect] setting does not work while the following images are played back in a slide show:
 - 4K burst files
 - Images recorded with the Post Focus function
 - Group Pictures
- The [Duration] setting does not work while the following images are played back in a slide show:
 - Motion pictures
 - 4K burst files
 - Images recorded with the Post Focus function
 - Panorama pictures
 - Group Pictures

[Playback Mode]

Playback in [Normal Play], [Picture Only] or [Video Only] can be selected.

MENU →  [Playback] → [Playback Mode]

Select the group to play back by pressing ▲/▼, and then press [MENU/SET].

- If you select [Picture Only], 4K burst files and images recorded with the Post Focus function will also be played back.

[Protect]

You can set protection for pictures you do not want to delete by mistake.

MENU →  **[Playback]** → **[Protect]**

Select the picture. (P239)

- [999+] is displayed on the screen, if the total number of protects you set for a group pictures is more than 1000 pictures.

■ Cancelling all the [Protect] settings

Press **▲/▼** to select **[Cancel]**, and then press **[MENU/SET]**.



If you set the Write-Protect switch on the card to **[LOCK]**, images will not be deleted even when protection is not set for them.

- Be aware that the **[Protect]** setting may not work on other devices.
- Even if you protect pictures on a card, they will be deleted if the card is formatted.

[Rating]

You can set five different rating levels for images to do the following:

- Delete all the pictures not set as ratings.
- Check the JPEG image rating level in the file details display in operating systems such as Windows 10, Windows 8.1, and Windows 8.

MENU →  **[Playback]** → **[Rating]**

1 Select the picture. (P239)**2 Press ◀/▶ to set the rating level (1–5), and press [MENU/SET] to set.**

- When **[Multi]** has been selected, repeat steps **1** and **2** for each picture. (It is not possible to use the same setting for a multiple number of pictures.)
- The number of a group pictures will be displayed, if you set for a group pictures. [999+] is displayed, if the group pictures is more than 1000 pictures.

■ Cancelling all the [Rating] settings

Press **▲/▼** to select **[Cancel]**, and then press **[MENU/SET]**.

- **[Cancel]** cannot be selected when **[Playback Mode]** is set to **[Picture Only]** or **[Video Only]**.

- **[AVCHD]** motion pictures can only be set to **[★5]**.

[Title Edit]

You can add text (comments) to pictures. After text has been registered, it can be stamped in prints using [Text Stamp].

MENU →  **[Playback]** → **[Title Edit]**

1 Select the picture. (P239)

-  is displayed for pictures with titles already registered.

2 Enter the text. (P64)

- To delete the title, erase all the text in the text input screen.
- You can print out texts (comments) using the software “PHOTOfunSTUDIO”.
- You can set up to 100 pictures at one time with [Multi].

**Not available in these cases:**

- This function is not available in the following cases:
 - Motion pictures
 - 4K burst files
 - Images recorded with the Post Focus function
 - Images recorded with [Quality] set to [RAW $\frac{1}{2}$], [RAW $\frac{1}{4}$] or [RAW]

[Face Rec Edit]

You can clear and replace all information relating to face recognition in selected images.

MENU →  **[Playback]** → **[Face Rec Edit]**





- 1 Press ▲/▼ to select [REPLACE] or [DELETE], and then press [MENU/SET].**
- 2 Press ◀/▶ to select the picture and then press [MENU/SET].**
- 3 Press ◀/▶ to select the person and then press [MENU/SET].**
- 4 (When [REPLACE] is selected)
Press ▲/▼/◀/▶ to select the person to replace and then press [MENU/SET].**

- Cleared information regarding the [Face Recog.] cannot be restored.
- The Face Recognition information of pictures in a group has to be edited at once.
(You cannot edit one picture at a time.)
- Editing of group pictures can be performed only on the first picture of each set.

[RAW Processing]

You can process the pictures taken in RAW format. The processed pictures will be saved in JPEG format.

MENU →  **[Playback]** → **[RAW Processing]**

- 1 Select RAW images with  , and then press **[MENU/SET]**.
- 2 Press  /  to select an item.

- You can set the following items. The settings you used for the recording are selected when you start setting these items.



[White Balance]	Allows you to select a White Balance preset and adjust it. If you select an item with  , you can process the image with the setting at the time of recording.
[Brightness correction]	Allows you to correct the brightness within the range between -2 EV and $+2$ EV.
[Photo Style]	Allows you to select a photo style effect. • You cannot select [V-Log L] for pictures taken with effects other than [V-Log L]. • The effect for pictures taken with [V-Log L] will be fixed to [V-Log L].
[i.Dynamic]	Allows you to select an [i.Dynamic] setting.
[Contrast]	Allows you to adjust the contrast.
[Highlight]	Allows you to adjust the brightness of bright portions.
[Shadow]	Allows you to adjust the brightness of dark portions.
[Saturation]/ [Color Tone]	Allows you to adjust the saturation. (When [Monochrome], [L.Monochrome] or [L.Monochrome D] is selected in [Photo Style], you can adjust the colour tone.)
[Filter Effect]	Allows you to select a filter effect. (Only when [Monochrome], [L.Monochrome] or [L.Monochrome D] is selected in [Photo Style].)
[Grain Effect]	You can set the graininess. (Only when [Monochrome], [L.Monochrome] or [L.Monochrome D] is selected for [Photo Style].)
[Noise Reduction]	Allows you to adjust the noise reduction setting.
[i.Resolution]	Allows you to select an [i.Resolution] setting.
[Sharpness]	Allows you to adjust the resolution effect.

[More Settings]	<p>Use ▲/▼ to select items and press [MENU/SET] to perform the following operations.</p> <p>[Reinstate Adjustments]: Returns the settings to the ones you used during the recording.</p> <p>[Color Space]: Allows you to select a [Color Space] setting from [sRGB] or [Adobe RGB].</p> <p>[Picture Size]: Allows you to select the size in which the image will be saved in JPEG format.</p>
------------------------	--

- 3 Press [MENU/SET] and set.**
 - Refer to “How to set each item” on P245.
- 4 Press [MENU/SET].**
 - This operation returns you to the screen in step 2. To set other items, repeat steps 2 through 4.
- 5 Select [Begin Processing] with ▲/▼, and then press [MENU/SET].**

■ How to set each item

Button operation	Touch operation	Description of operation
	Dragging	Selects a setting.
▲	[WB K Set]	Displays the screen that lets you set the colour temperature. (When [K], [M], [P] or [A] is selected in [White Balance])
▼	[Adjust.]	Displays the screen that lets you fine-adjust the White Balance. (only when [White Balance] is set)
[DISP.]	[DISP.]	Displays the comparison screen.
[MENU/SET]	[Set]	Sets the adjusted level and returns you to the item selection screen.





- When [Noise Reduction], [i.Resolution] or [Sharpness] is selected, the comparison screen cannot be displayed.
- Each time you touch the screen twice, the display switches between enlarged and normal view.

On the comparison screen, you can use the following operations to make adjustments:

(A) Current setting

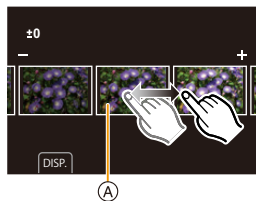
Button operation	Touch operation	Description of operation
	Dragging	Selects a setting.
[DISP.]	[DISP.]	Returns you to the setting screen.
[MENU/SET]	[Set]	Sets the adjusted level and returns you to the item selection screen.



- If you touch the picture at the centre, it will be enlarged.
If you touch , the picture will be reduced to the original size.

- The effects applied through the RAW processing on the camera and those applied through the RAW processing on the software “SILKYPIX Developer Studio” are not completely identical.
- RAW images recorded with the camera are always recorded in the [4:3] (5184×3888) aspect ratio. When you process them with [RAW Processing] in the [Playback] menu, however, their aspect ratio and [Ex. Tele Conv.] ([Rec]) settings at the time of recording will be applied to them.
- (When setting [Picture Size] in [More Settings])
When images enlarged with [Ex. Tele Conv.] ([Rec]) are processed, their picture size cannot be set larger than the size at the time of recording.
- The [White Balance] setting of pictures taken with multiple exposures is fixed to the setting at the time of recording.
- Edit group images one by one. The edited images will be saved as new images separate from the original group images.

 **Not available in these cases:**

- [RAW Processing] is not available when an HDMI micro cable is connected.
- RAW processing cannot be performed on RAW images recorded with other devices.

[Light Composition]

Select multiple frames from 4K burst files that you wish to combine. Parts of the image that are brighter than the preceding frame will be superimposed on the preceding frame to combine the frames into one picture.

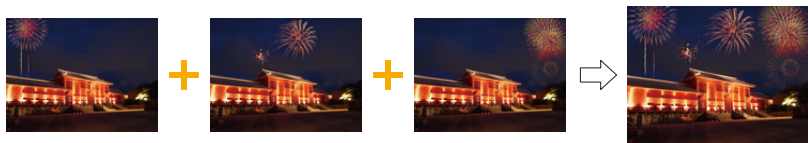

[MENU] → **[▶]** **[Playback]** → **[Light Composition]**

- 1 Press **◀/▶** to select the 4K photo burst files and press **[MENU/SET]**.
- 2 Choose the combining method, and then press **[MENU/SET]**.

[Composite Merging] setting

Select the frames you want to combine to superimpose brighter parts.

- 1 Drag the slide bar or use **▲/▼/◀/▶** to select the frames to combine.
- 2 Press **[MENU/SET]**.
 - The selected frames are remembered, and the display goes to the preview screen.
 - Press **▲/▼** to select items and press **[MENU/SET]** to perform the following operations.



– [Next]:

Lets you select more frames for combining.

– [Reselect]:

Discards the frame selected immediately before and lets you select a different image.

- 3 Repeat steps 1 and 2 to select more frames to combine.
 - You can select up to 40 frames.
- 4 Press **▲/▼** to select [Save], and then press **[MENU/SET]**.

[Range Merging] setting

Select the first and last frames to superimpose the brighter parts of the frames between them.

- 1 Select the frame of the first picture, and press **[MENU/SET]**.
 - The selection method is the same as in step 1 of [Composite Merging] setting.
- 2 Select the frame of the last picture, and press **[MENU/SET]**.

- 3 Select **[Yes]** at the confirmation screen, and then press **[MENU/SET]**.

• Pictures are saved in JPEG format. Recording information (Exif information) of the first frame such as shutter speed, aperture, and ISO sensitivity are also registered.

[Sequence Composition]

Select multiple frames from a 4K burst file to create a sequence composition of a moving subject into one picture.



MENU → **[Playback]** → **[Sequence Composition]**

- 1 Press **◀/▶** to select the 4K photo burst files and press **[MENU/SET]**.
- 2 Select frames to combine.

Select the frames so that the moving subject will not overlap on the preceding or subsequent frames. (The sequence composition may not be created properly if the subject overlaps.)

- 1 Drag the slide bar or use **▲/▼/◀/▶** to select the frames to combine.
- 2 Press **[MENU/SET]**.
 - The selected frames are remembered, and the display goes to the preview screen.
 - Press **▲/▼** to select items and press **[MENU/SET]** to perform the following operations.
 - **[Next]**: Lets you select more frames for combining.
 - **[Reselect]**: Discards the frame selected immediately before and lets you select a different image.
- 3 Repeat steps 1 and 2 to select more frames to combine.
 - You can select 3 to 40 frames.
- 4 Press **▲/▼** to select **[Save]**, and then press **[MENU/SET]**.



- Pictures are saved in JPEG format. Recording information (Exif information) of the first frame such as shutter speed, aperture, and ISO sensitivity are also registered.

**Tips for [Sequence Composition]**

We recommend using a tripod to take pictures for [Sequence Composition].

[Clear Retouch]

- [Clear Retouch] is a setting to be used through touch operations and automatically enables touch operation.

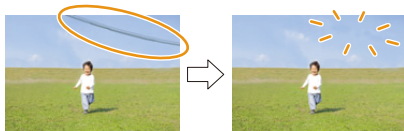

MENU → **[Playback]** → **[Clear Retouch]**

- 1 Press **◀/▶** to select a picture, and then press **[MENU/SET]**.
- 2 Drag your finger over the part you want to delete.
 - The parts to be erased are coloured.
 - To return the coloured part back to its previous state, touch **[Undo]**.

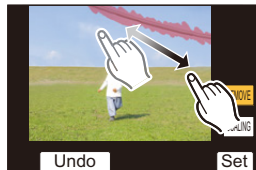

💡 Erasing details (enlarging the display)

- 1 Touch **[SCALING]**.
 - Pinching out/pinching in the screen allows you to enlarge/reduce it.
 - Dragging the screen allows you to move the enlarged part.
- 2 Touch **[REMOVE]**.
 - This will bring you back to the operation of dragging your finger over the part you want to delete. The part you want to delete can be dragged even while the picture is enlarged.



- 3 Touch **[Set]**.
- 4 Touch **[Save]** or press **[MENU/SET]**.

- Pictures may appear unnatural because the background of deleted parts is artificially created.
- For group pictures, perform [Clear Retouch] on each picture. (They cannot be edited at once.)
- When [Clear Retouch] is performed on group pictures, they are saved as new pictures separate from the original ones.

🚫 Not available in these cases:

- [Clear Retouch] is not available in the following cases:
 - When the viewfinder display is in use
 - When an HDMI micro cable is connected
- This function is not available in the following types of images:
 - Motion pictures
 - 4K burst files
 - Images recorded with the Post Focus function
 - Panorama pictures
 - Pictures taken with **[RAW]**

[Text Stamp]

You can stamp recording information on recorded images.



MENU → **[Playback]** → **[Text Stamp]**

1 Select the picture. (P239)

- **[☑]** appears on screen if the picture is stamped with text.

2 Press ▲/▼ to select [Set], and then press [MENU/SET].

[Shooting Date]	Stamps the recording date.
[Name]	<p>[👤] (Face Recognition): Name registered in [Face Recog.] will be stamped.</p> <p>[🐾/🐶] (Baby/Pet): Name registered in [Profile Setup] will be stamped.</p>
[Location]	Stamps the travel destination name set under [Location].
[Travel Date]	Stamps the travel date set under [Travel Date].
[Title]	Title input in the [Title Edit] will be stamped.

3 Press [↩] to return to the previous screen.

4 Press ▲ to select [OK], and then press [MENU/SET].

- When you print pictures stamped with text, the date will be printed over the stamped text if you specify printing of the date at the photo shop or on the printer.
- You can set up to 100 pictures at one time in [Multi].
- The picture quality may deteriorate when text stamping is carried out.
- When you stamp pictures in a group, the stamped ones are saved separately from the original ones in the group.

ⓘ Not available in these cases:

- This function is not available in the following cases:
 - Motion pictures
 - 4K burst files
 - Images recorded with the Post Focus function
 - Panorama pictures
 - Pictures recorded without setting the clock and title
 - Pictures stamped with [Text Stamp]
 - Pictures recorded with [Quality] set to [RAW]

[Resize]

To allow easy posting to web pages, attachment to e-mail etc., picture size (number of pixels) is reduced.



MENU → **[Playback]** → **[Resize]**

Select the picture and size.

[Single] setting

- 1 Press to select the picture, and then press [MENU/SET].
- 2 Press to select the size, and then press [MENU/SET].

**[Multi] setting**

- 1 Press to select the size, and then press [MENU/SET].
- 2 Press to select the picture, and then press [MENU/SET] to set (repeat).
 - The setting is cancelled when [MENU/SET] is pressed again.
- 3 Press [DISP.] to execute.

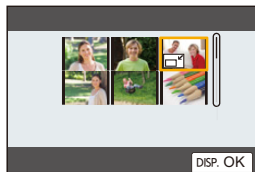

- You can set up to 100 pictures at one time in [Multi].
- The picture quality of the resized picture will deteriorate.

**Not available in these cases:**

- This function is not available in the following cases:
 - Motion pictures
 - 4K burst files
 - Images recorded with the Post Focus function
 - Panorama pictures
 - Group Pictures
 - Pictures stamped with [Text Stamp]
 - Pictures recorded with [Quality] set to [RAW]

[Cropping]

You can enlarge and then clip the important part of the recorded picture.



MENU → **[Playback]** → **[Cropping]**

- 1 Press **◀/▶** to select the picture, and then press **[MENU/SET]**.
- 2 Use the rear dial and press **▲/▼/◀/▶** to select the parts to be cropped.

Button operation	Touch operation	Description of operation
		Enlarges the picture
		Reduces the picture
▲/▼/◀/▶	Drag	Moves the enlarged area

3 Press **[MENU/SET]**.

- The picture quality of the cropped picture will deteriorate.
- Crop one picture at a time when you want to crop the pictures in a picture group. (You cannot edit all pictures in a group at once.)
- When you crop pictures in a group, the cropped ones are saved separately from the original ones in the group.
- Information regarding the Face Recognition in the original picture will not be copied to images having undergone [Cropping].



Not available in these cases:

- This function is not available in the following cases:
 - Motion pictures
 - 4K burst files
 - Images recorded with the Post Focus function
 - Panorama pictures
 - Pictures stamped with [Text Stamp]
 - Pictures recorded with [Quality] set to [RAW]

[Rotate] (The picture is rotated manually.)

Rotate pictures manually in 90° steps.

- The [Rotate] function is disabled when [Rotate Disp.] is set to [OFF].

MENU →  **[Playback]** → **[Rotate]**

1 Press </> to select the picture and then press [MENU/SET].

2 Select the rotation direction.



The picture rotates clockwise in steps of 90°.



The picture rotates counter-clockwise in steps of 90°.

**[Video Divide]**

Recorded motion picture and 4K burst files can be divided in two. It is recommended for when you want to divide a part you need with a part you do not need.

Dividing a file is permanent. Decide before you divide!

MENU →  **[Playback]** → **[Video Divide]**

1 Press </> to select the file to divide, and then press [MENU/SET].

2 Press ▲ at the location to divide.

- You can finely adjust the location for division by pressing </> while the file is paused.

3 Press ▼.

- The file may be lost if the card or battery is removed while processing the dividing.

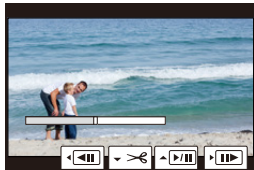
**Not available in these cases:**

- It may not be possible to divide a file at a point near the beginning or end.
- This function is not available in the following cases:
 - When the recording time is short.

[Time Lapse Video]

This function allows you to create a motion picture from a picture group recorded with [Time Lapse Shot].

MENU →  **[Playback]** → **[Time Lapse Video]**

- 1 Select the [Time Lapse Shot] picture group with ◀/▶, and then press [MENU/SET].
- 2 Create a motion picture by selecting the methods for creating it.
 - Refer to P142 for details.

[Stop Motion Video]

A Motion picture is created from group pictures taken with [Stop Motion Animation].

MENU →  **[Playback]** → **[Stop Motion Video]**

- 1 Select the Stop Motion Animation group with ◀/▶, and then press [MENU/SET].
- 2 Create a motion picture by selecting the methods for creating it.
 - Refer to P142 for details.

[Rotate Disp.] (The picture is automatically rotated and displayed.)

This mode allows you to display pictures vertically if they were recorded holding the camera vertically.

MENU →  **[Playback]** → **[Rotate Disp.]** → **[ON]**

 **Not available in these cases:**

- When you play back pictures on a PC, they cannot be displayed in the rotated direction unless the OS or software is compatible with Exif.
Exif is a file format for still pictures which allows recording information etc. to be added. It was established by “JEITA (Japan Electronics and Information Technology Industries Association)”.

[Picture Sort]

You can set the order in which the camera displays images during playback.

MENU →  **[Playback]** → **[Picture Sort]**

[FILE NAME]	Displays images by folder name/file name. This display format allows you to locate images in the card easily.
[DATE/TIME]	Displays images by recording date. If the card contains pictures taken with more than one camera, this display format is convenient for looking for images.

- When you insert another card, images may not be displayed by **[DATE/TIME]** first. The images will be displayed by **[DATE/TIME]** if you wait for a while.

[Delete Confirmation]

This sets which option, **[Yes]** or **[No]**, will be highlighted first when the confirmation screen for deleting a picture is displayed.

It is set to **[“No” first]** at the time of purchase.

MENU →  **[Playback]** → **[Delete Confirmation]**

[“Yes” first]	[Yes] is highlighted first, so deletion can be done quickly.
[“No” first]	[No] is highlighted first. Accidental deletion of pictures is avoided.

What you can do with the Wi-Fi®/Bluetooth® function

Controlling with a Smartphone

- Remote shooting (P267)
- Playing back/saving recorded images (P270)
- Editing motion pictures recorded with Snap Movie (P275)



Connect to a smartphone that supports Bluetooth Low Energy to expand the scope of applications

- Pairing (connection setup) (P260)
- Camera power operations (P266)
- Shutter Remote Control (Bulb recording) (P268)
- Sending recorded images to a smartphone automatically (P271)
- Recording location information of a smartphone on recorded images (P273)
- Synchronising the camera's clock with a smartphone (P274)



Displaying pictures on a TV (P276)



Printing Wirelessly (P281)



Sending images to AV device (P282)



Sending images to PC (P283)

- These operating instructions refer to both smartphones and tablets as smartphones from this point on unless noted otherwise.

Wi-Fi function/Bluetooth function

■ Before Use

- **Set the clock.** (P39)
- To use the Wi-Fi function on this unit, a wireless access point or a destination device equipped with the wireless LAN function is required.

■ About the WIRELESS connection lamp

Lit blue	When the Wi-Fi/Bluetooth function is ON or connected
Blinking blue	When sending image data by operating the camera

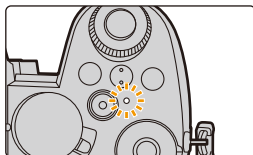

- In [Wireless Connection Lamp] in the [Setup] menu, you can set the lamp so that it will not light/flash. (P230)

■ About the [Wi-Fi] button

In these operating instructions, a Fn button to which [Wi-Fi] is assigned is referred to as the [Wi-Fi] button.

(By default, [Wi-Fi] is assigned to [Fn4] when the camera is in Recording Mode, while it is assigned to [Fn1] when the camera is in Playback Mode.)

- For information about the Fn button, refer to P60.

Steps for pressing [Wi-Fi] (in Recording Mode)

1 Touch [Fn].



2 Touch [Fn4].



■ Operations that can be performed by pressing [Wi-Fi]

When the camera is not connected to Wi-Fi, press [Wi-Fi]. The camera will then be ready to be connected to the smartphone. You can connect the camera directly to the smartphone. (P262)

- When the camera is ready to be connected, you can press [DISP.] to connect with the same settings as used previously. This is a convenient and quick way to establish a connection. (P289)

After connecting to a Wi-Fi network, you can perform the following operations by pressing [Wi-Fi]:

[Terminate the Connection]	Terminates the Wi-Fi connection.
[Change the Destination]	Terminates the Wi-Fi connection, and allows you to select a different Wi-Fi connection.
[Change Settings for Sending Images]	(P279)
[Register the Current Destination to Favorite]	Registering the current connection destination or the connection method, you can easily connect with the same connection method next time.
[Network Address]	(P292)

• Depending on the Wi-Fi function being used or the connection destination, you may not be able to perform some of these operations.

■ Describing method

When “select [Select a destination from History]”, etc. is described in a step, perform any of the following operations.

Button operation: Select [Select a destination from History] with the cursor button, and then press [MENU/SET].

Touch operation: Touch [Select a destination from History].



• Do not remove the memory card or battery or move to an area without any reception while sending images.

- The camera cannot be used to connect to a public wireless LAN connection.
- We strongly recommend that you set an encryption to maintain information security.
- It is recommended to use a fully charged battery when sending images.
- When sending images on a mobile network, high packet communication fees may be incurred depending on the details of your contract.
- Pictures may not be completely sent depending on radio wave conditions. If the connection is terminated while sending pictures, pictures with missing sections may be sent.

Connecting to a smartphone

You can use a smartphone to operate the camera from a remote location.

You need to install “Panasonic Image App” (referred to as “Image App” from this point on) on your smartphone.

Installing “Panasonic Image App”

“Panasonic Image App” is an application for smartphones provided by Panasonic.

• OS

App for Android™: **Android 4.4 or higher**
(Android 5.0 or higher is required to use the Bluetooth function)

App for iOS: **iOS 9.3 or higher**
(The Bluetooth function cannot be used with the iPad 2)

- 1 **Connect the smartphone to a network.**
- 2 **(Android) Select “Google Play™ Store”.**
(iOS) Select “App Store”.
- 3 **Enter “Panasonic Image App” or “LUMIX” into the search box.**
- 4 **Select “Panasonic Image App”  and install it.**

- Use the latest version.
- Supported OSs are current as of April 2022 and are subject to change.
- The service may not be able to be used properly depending on the type of smartphone being used.

Refer to the support site below for details about the “Image App”.

<https://panasonic.jp/support/global/cs/dsc/>

(This Site is English only.)

- When downloading the app on a mobile network, high packet communication fees may be incurred depending on the details of your contract.
- Read the [Help] in the “Image App” menu for further details on how to operate.
- When you operate the “Image App” on the smartphone that is connected to the camera via Wi-Fi, [Help] in the “Image App” may not be displayed depending on the smartphone. In this case, after terminating the connection to the camera, reconnect the smartphone to a mobile phone network such as the 3G or LTE network or to a Wi-Fi router, and then display [Help] in the “Image App”.
- Some of the screens and information provided in these operating instructions may differ from your device depending on the supported OS and “Image App” version.

Connecting to a Smartphone (Bluetooth Connection)

Follow a simple connection setup procedure (pairing) to connect to a smartphone that supports Bluetooth Low Energy. When pairing is set up, the camera also automatically connects to the smartphone via Wi-Fi.

• Supported smartphones

Android: Android 5.0 or higher equipped with Bluetooth 4.0 or higher (excluding those that do not support Bluetooth Low Energy)

iOS: iOS 9.3 or higher (excluding the iPad 2)

■ First-time connection

You need to set up pairing (connection) for the first time only.

When pairing is set up, a Wi-Fi connection is made automatically.

On the camera

MENU →  [Setup] → [Bluetooth] → [Bluetooth] → [SET] → [Pairing]

- The camera enters pairing standby mode and displays its device name.

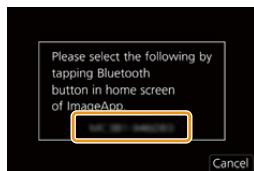

On your smartphone

1 Start "Image App".

- If a message is displayed indicating that the smartphone is searching for cameras, close the message.

2 Select [Bluetooth].

3 Turn on the Bluetooth.

4 Select the device name displayed on the camera's screen from the [Camera enable to be registered] list.

- Bluetooth connection between the camera and the smartphone will be made. (For Android devices) A Wi-Fi connection will be made by selecting [Connection].

If you are using an Android device, follow the steps up to here to complete the setup. Proceed to the steps below only if you are using an iOS device (iPhone/iPod touch/iPad).

- If [Wi-Fi Password] (P291) is set to [OFF] on the camera, select [Wi-Fi Setup]. (At the time of purchase, [Wi-Fi Password] is set to [OFF])
- If [Wi-Fi Password] is set to [ON] on the camera, you need to install the profile.

① Install the profile.

- If a pass code is set on the smartphone, you need to enter it.

② Press the home button to close the browser.

5 Turn on the Wi-Fi function in the setup menu.

6 On the Wi-Fi setting screen, select the SSID displayed on the camera. (The device name selected in step 4)

- If the SSID is not displayed, it may be displayed after the Wi-Fi function is turned off and on.
- When you need to change the connected device, follow the on-screen message to change the setting.



7 Start “Image App”.

- The paired smartphone will be registered as a paired device after connected via Wi-Fi.

■ Connecting to a Paired Smartphone

On the camera

MENU →  [Setup] → [Bluetooth] → [Bluetooth] → [ON]

On your smartphone

1 Start “Image App” and then select [Bluetooth].

- If a message is displayed indicating that the smartphone is searching for cameras, close the message.

2 Turn on the Bluetooth.

3 Select the camera (device name) you want to connect to from the [Camera registered] list.

- Even if you set up pairing with more than one smartphone, you can only connect to one smartphone at a time.

■ End Bluetooth Connection

MENU →  [Setup] → [Bluetooth] → [Bluetooth] → [OFF]

- The connection will be terminated and the camera’s Bluetooth function will be deactivated.
- Even if you terminate the connection, the pairing information for it will not be deleted.

■ Cancelling Pairing

On the camera



1 Select the menu.

MENU →  [Setup] → [Bluetooth] → [Bluetooth] → [SET] → [Delete]

2 Select the smartphone you want to delete.

On your smartphone

Select the camera (device name) for which to delete the pairing information from the [Camera registered] list.

- [] is displayed on the recording screen during Bluetooth connection. When the Bluetooth function is enabled, but a connection is not established, [, translucent] appears translucent.
- When it takes time to set up pairing between a smartphone and a camera, delete the pairing information of both devices and register them again. This may enable the devices to be recognised properly.
- Up to 16 smartphones can be registered. If you try to register more than 16 devices, the smartphone with the oldest registration history will be replaced.
- Performing [Reset Network Settings] will delete registered device information.

Connecting to a Smartphone (Wi-Fi connection)

Use Wi-Fi to connect the camera and a smartphone that does not support Bluetooth Low Energy.

- You can also connect via Wi-Fi to a smartphone that supports Bluetooth Low Energy by following the same steps.

Connecting Without Entering a Password

You can easily connect to the camera via Wi-Fi without entering a password on your smartphone.

On the camera

MENU →  **[Setup]** → **[Wi-Fi]** → **[Wi-Fi Function]** → **[New Connection]** → **[Remote Shooting & View]**

(A) SSID

- The information required for directly connecting your smartphone to this unit (SSID) is displayed.
- You can also display the information by pressing [Wi-Fi] on the camera.



On your smartphone

- 1 Turn on the Wi-Fi function in the setup menu.**
- 2 On the Wi-Fi setting screen, select the SSID displayed on the camera.**
- 3 Start “Image App”.**
 - When the connection confirmation screen is displayed on the camera, select [Yes] to connect. (For first time connection only)

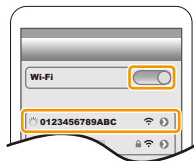

At the time of purchase, [Wi-Fi Password] is set to [OFF].

Before connecting to a Wi-Fi network, ensure that the device displayed on the connection confirmation screen is the one you actually want to connect to. When a wrong device is displayed, if you select [Yes], the camera will automatically connect to that device.

We recommend that you set [Wi-Fi Password] (P291) to [ON] if, for example, there is another Wi-Fi device nearby.

Using Password Authentication to Connect

When [Wi-Fi Password] is set to [ON], you can enhance security by using manual entry of a QR code for password authentication.

Preparations: (On the camera) Set [Wi-Fi Password] to [ON]. (P291)

■ Scanning QR code to connect

On the camera

MENU →  **[Setup]** → **[Wi-Fi]** → **[Wi-Fi Function]** → **[New Connection]** → **[Remote Shooting & View]**

(A) SSID and password

(B) QR code

- The information (QR Code, SSID and Password) required for directly connecting your smartphone to the camera is displayed.
- You can also display the information by pressing [Wi-Fi] on the camera.

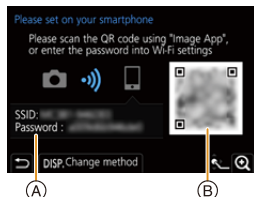

On your smartphone

1 Start “Image App”.

2 Select [QR code].

- When the smartphone is connected to a wireless access point, it may take time to display [QR code].
- (For iOS devices) A confirmation screen will be displayed. Select [OK] to proceed.

3 Use the “Image App” to scan the QR code displayed on the screen of the camera.

- To enlarge the QR code, press [MENU/SET] on the camera.

If you are using an Android device, follow the steps up to here to complete the setup. Proceed to the steps below only if you are using an iOS device (iPhone/iPod touch/iPad).

4 Install the profile.

- If a pass code is set on the smartphone, you need to enter it.

5 Press the home button to close the browser.

6 Turn on the Wi-Fi function in the smartphone’s setting menu.

7 On the Wi-Fi setting screen, select the SSID displayed on the camera.

8 Start “Image App”.

- (iOS devices) Steps **1** through **5** are not required from the second time on.

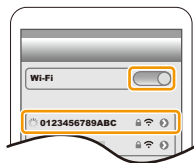

Manually entering a password to connect

On the camera

MENU → ⚙ [Setup] → [Wi-Fi] → [Wi-Fi Function] → [New Connection] → [Remote Shooting & View]

(A) SSID and password

(B) QR code

- The information (QR Code, SSID and Password) required for directly connecting your smartphone to the camera is displayed.
- You can also display the information by pressing [Wi-Fi] on the camera.

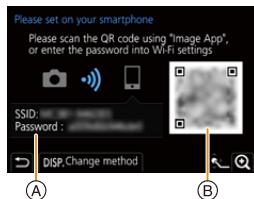

On your smartphone

- 1 Turn on the Wi-Fi function in the setup menu.
- 2 On the Wi-Fi setting screen, select the SSID displayed on the camera.
- 3 Enter the password displayed on the camera into the smartphone. (For first time connection only)
- 4 Start "Image App".

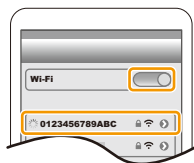

Changing the Wi-Fi connection method

To change the connection method, follow the steps below:

MENU → ⚙ [Setup] → [Wi-Fi] → [Wi-Fi Function] → [New Connection] → [Remote Shooting & View] → [DISP.] button

or

Wi-Fi → [DISP.] button → [New Connection] → [Remote Shooting & View] → [DISP.] button

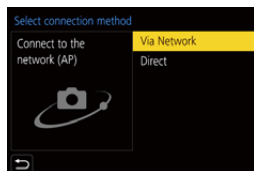

■ Connecting via network

On the camera

1 Select [Via Network].

- Follow the connection procedure described on [P286](#) to connect the camera to a wireless access point.

On your smartphone

2 Turn on the Wi-Fi function in the setup menu.

3 Connect the smartphone to the wireless access point to which the camera is connected.

4 Start “Image App”.

■ Connecting directly

On the camera

1 Select [Direct].

- Select [WPS Connection], and follow the connection procedure described on [P288](#) to connect the camera to the smartphone.

On your smartphone

2 Start “Image App”.

Terminating the Wi-Fi connection

1 Set the camera to Recording Mode.

- Press the shutter button halfway to return to recording mode.

2 Select the camera’s menu items to terminate the Wi-Fi connection.

MENU →  [Setup] → [Wi-Fi] → [Wi-Fi Function]
→ [Yes]

- You can also terminate the connection by pressing [Wi-Fi] on the camera.

3 On the smartphone, close “Image App”.

- When recording with [4K Pre-Burst] with the smartphone, terminate the connection only after switching to 4K Burst recording by pressing [] on the camera.

Terminate the Wi-Fi connection?

Yes

No

Operating the Camera with a Smartphone

■ Required wireless connectivity mode

The wireless connectivity mode required varies depending on the function to be used after connecting to a smartphone.

Wireless connectivity required	Support for Bluetooth Low Energy
Bluetooth	Indicates that the function can be used with smartphones that support Bluetooth Low Energy.
Wi-Fi	Indicates that the function can be used with smartphones that do not support Bluetooth Low Energy.
Bluetooth Wi-Fi	Indicates that the function can be used with smartphones that support Bluetooth Low Energy. • Indicates that the function requires you to connect to a smartphone using both Bluetooth and Wi-Fi.

Camera power operations

Wireless connectivity required: Bluetooth Wi-Fi

Even when the camera is turned off, it can be started up remotely and operated on your smartphone. You can turn on the camera to record from a remote location or view images even when the camera is in your bag.



- 1 Make a Bluetooth connection to the smartphone. (P260)
- 2 Select the camera's menu.

MENU → [Setup] → [Bluetooth] → [Remote Wakeup] → [ON]

- 3 Set the camera on/off switch to [OFF].
- 4 On the smartphone, start up the "Image App", and set the Bluetooth function to a state in which a connection can be made (standby state).
- 5 Operate the smartphone.

- 1 Select [Home].
- 2 Select [Remote operation].



- The camera automatically turns on, allowing it to make a Wi-Fi connection automatically.
 - (iOS devices) Depending on the connection status of the smartphone, you may need to change the connected device on the Wi-Fi setup screen. Follow the on-screen message on the smartphone to change the setting.

■ Turning off the camera

Operate the smartphone.

- 1 Select [].
- 2 Select [ OFF].

- When [Remote Wakeup] is set to [ON], the Bluetooth function continues to operate even after the camera is turned off, thus causing the battery to drain.

Remote shooting

Wireless connectivity required: Wi-Fi

You can use the smartphone to record from a remote location while viewing the live view images from the camera.

- 1 **Connect to a smartphone. (P262)**
- 2 **Operate the smartphone.**

If the camera is already connected to the smartphone via Bluetooth, select [] → [Remote operation].

(iOS devices) If you need to change the connected device on the Wi-Fi setup screen, follow the on-screen message to change the setting.

- 1 Select [].
- 2 Record an image.



- The recorded images are saved in the camera.
- Some settings are not available.



■ Operation Method During Remote Recording

Set either the camera or the smartphone as the priority control device to be used during remote recording.

MENU →  **[Setup]** → **[Wi-Fi]** → **[Wi-Fi Setup]** → **[Priority of Remote Device]**

 [Camera]	Allows you to perform operations with both the camera and the smartphone. • The camera's dial settings, etc. cannot be changed with the smartphone.
 [Smartphone]	Allows you to perform operations only with the smartphone. • The camera's dial settings, etc. can be changed with the smartphone. • To end remote recording, press any of the buttons on the camera to turn on the screen, and select [End].

- The setting of this function cannot be changed while the connection is active.

Not available in these cases:

- In the following cases, remote recording does not work:
 - [Panorama Shot] (Scene Guide Mode)*
 - When using [Time Lapse Shot]
- * When [Priority of Remote Device] is set to [] ([Smartphone]), you can temporarily switch to Programme AE Mode for remote recording. The camera returns to normal operation after the remote recording has finished.

[Shutter Remote Control]

Wireless connectivity required: **Bluetooth**

You can use the smartphone as a remote control for the shutter.

- 1 Make a Bluetooth connection to the smartphone. (P260)**
- 2 Operate the smartphone.**

- 1** Select [].
- 2** Select [Shutter Remote Control].
- 3** Take pictures.







About [B] (Bulb)

You can perform [B] (Bulb) recording by setting the shutter speed to [B] (Bulb) in Manual Exposure Mode. (Up to 30 minutes)

This function is useful when you take pictures of stars in the night sky or a night scene, since the shutter can be kept open from start of recording to end of recording.

Operate the smartphone

- 1** Press [] to start recording (Press and hold [])
 - 2** Release your finger from [] to end recording
- Slide [] in the direction of [LOCK] to record with the shutter button fixed in the fully pressed condition. (Slide [] back in the opposite direction or press the shutter button of the camera to end recording.)
 - If Bluetooth is disconnected during the [B] (Bulb) recording, reconnect Bluetooth and perform the operation to end recording using the smartphone.



- Refer to [Help] in the “Image App” for more details about the [Shutter Remote Control] operation of the “Image App”.
- [Shutter Remote Control] is available when the camera on/off switch is set to [ON].
- The live view image of the camera cannot be monitored on the smartphone.
- When the camera turns off after [Sleep Mode] is activated during recording, you can reselect [Shutter Remote Control] on the smartphone to turn it on again. (The following settings are required.)
 - [Remote Wakeup]: [ON]
 - [Auto Transfer]: [OFF]
- The camera cannot be turned on by using [Shutter Remote Control].



■ Reducing the time to recover from [Sleep Mode]

Select the smartphone function to be used as a priority function when waking the camera from [Sleep Mode] with a smartphone.

Preparation:

Set [Bluetooth] and [Remote Wakeup] to [ON]. (P266)

MENU →  **[Setup]** → **[Bluetooth]** → **[Returning from Sleep Mode]**

	[Remote / Transfer Priority]	Shortens the time required to wake the camera with [Remote operation] or [Transfer image].
	[Shutter Remote Priority]	Shortens the time required to wake the camera with [Shutter Remote Control].

Playing back/saving recorded images

Wireless connectivity required: Wi-Fi

- 1 Connect to a smartphone. (P262)
- 2 Operate the smartphone.

If the camera is already connected to the smartphone via Bluetooth, select [] → [Remote operation].

(iOS devices)

Depending on the connection status of the smartphone, you may need to change the connected device on the Wi-Fi setup screen. Follow the on-screen message on the smartphone to change the setting.

- 1 Select [].

- You can switch the images to be displayed by selecting the icon (A) on the top left of the screen. To display images stored in the camera, select [LUMIX].

(To play back the image)

- 2 Touch the image to enlarge it.

- When you play a motion picture, image quality differs from that of the actual recorded motion picture. In addition, depending on the smartphone or conditions of use, the image quality may deteriorate or the sound may skip during motion picture or picture playback.

(To save the image)

- 3 Touch and hold and then drag the image.

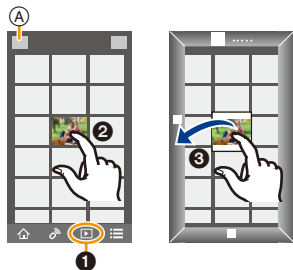

- An OS version of Android 7.0 or higher or iOS 10.0 or higher is required to save pictures in RAW format.
- Depending on the smartphone or its OS version, pictures in RAW format may not be displayed correctly.
- You cannot save the following types of images:
 - Motion pictures in AVCHD and 4K formats
 - 4K burst files
 - Images recorded with the Post Focus function



Transferring recorded images automatically

Wireless connectivity required: **Bluetooth** **Wi-Fi**

The camera automatically transfers recorded images to a Bluetooth-connected smartphone via Wi-Fi.

- 1 **Make a Bluetooth connection to the smartphone. (P260)**
- 2 **Select the camera's menu.**

MENU →  **[Setup]** → **[Bluetooth]** → **[Auto Transfer]** → **[ON]**

- If a confirmation screen is displayed on the camera asking you to terminate the Wi-Fi connection, select [Yes] to terminate it.
- 3 **On the smartphone, select [Yes] (Android devices) or [Wi-Fi Setup] (iOS devices).**
 - The camera automatically makes a Wi-Fi connection.
 - (iOS devices) Follow the on-screen message on the smartphone to change the connected device on the Wi-Fi setup screen.
 - 4 **Check the send settings on the camera, and select [Set].**
 - To change the send setting, press [DISP]. (P279)
 - The camera will enter a mode where it can automatically transfer images and  will be displayed on the recording screen. (If it is not displayed, images cannot be transferred automatically. Check the status of the Wi-Fi connection to the smartphone.)
 - 5 **Take pictures on the camera.**
 - Every time you take a picture, it is automatically sent to a specified device.
 - While sending a file,  is displayed on the recording screen.



If you set [Auto Transfer] to [ON], the camera and the smartphone will be connected via Wi-Fi/Bluetooth and automatic transfer will be enabled the next time you turn on the camera and start "Image App" on the smartphone.

■ To stop the automatic transfer of images

Select [OFF] in step 2.

- A confirmation screen is displayed, asking you to terminate the Wi-Fi connection.

- **When [Auto Transfer] is set to [ON], [Wi-Fi Function] in [Wi-Fi] in the [Setup] menu cannot be used.**
- If the camera turns off during image transfer and the file transfer is cancelled, it will resend the files as soon as it is turned on again.
 - You may not be able to resend the files that did not get delivered if there is a change in their storage status. For example, if you replace the card before turning on the camera again, the files may not be resent.
 - If the number of files that did not get delivered is large, it may not be possible to resend all of the files.
- An OS version of Android 7.0 or higher or iOS 10.0 or higher is required to save pictures in RAW format.
- Depending on the smartphone or its OS version, pictures in RAW format may not be displayed correctly.
- You cannot automatically transfer the following types of images:
 - Motion pictures
 - 4K burst files
 - Images recorded with the Post Focus function

Recording location information

Wireless connectivity required: **Bluetooth**

The smartphone sends its location information to the camera via Bluetooth, and the camera performs recording while writing the acquired location information.

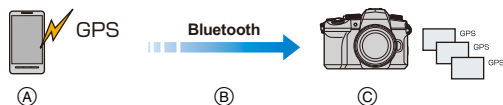

- (A) The smartphone acquires location information.
- (B) The smartphone sends the location information.
- (C) The camera performs recording while writing the location information.

Preparations:

Enable the GPS function on the smartphone.

- 1 **Make a Bluetooth connection to the smartphone.** (P260)
- 2 **Select the camera's menu.**

MENU → [Setup] → [Bluetooth] → [Location Logging] → [ON]

- The camera will enter a mode where location information can be recorded and [GPS] will be displayed on the recording screen.

- 3 **Take pictures on the camera.**

- Location information will be written to the recorded pictures.

When [GPS] appears translucent

Location information is not acquired, so data cannot be written. Positioning with the GPS on the smartphone may not be possible if the smartphone is in a location such as a building or a bag.

- Move the smartphone to a location where positioning performance can be optimised, such as one that offers a wide view of the sky, to try positioning.
- Refer to the operating instructions of your smartphone.

- Images with location information are indicated with [GPS].
- The smartphone drains its battery faster while acquiring location information.
- **Be sure to pay special attention to the privacy, the likeness rights, etc. of the subject when you use this function. Use at your own risk.**



Not available in these cases:

- Location information is not written to AVCHD motion pictures.

Automatically setting the clock

Wireless connectivity required: **Bluetooth**

Synchronise the [Clock Set] setting and the [Home] or [Destination] setting in [World Time], which are all located in the [Setup] menu of the camera, with the corresponding settings of a smartphone.

- 1 Make a Bluetooth connection to the smartphone. (P260)
- 2 Select the camera's menu.

MENU → ⌘ [Setup] → [Bluetooth] → [Auto Clock Set] → [ON]

Editing motion pictures recorded with Snap Movie

Wireless connectivity required: Wi-Fi

Using a smartphone, you can combine motion pictures recorded with the camera's [Snap Movie] function (P176). Music can be added to motion pictures to be combined.

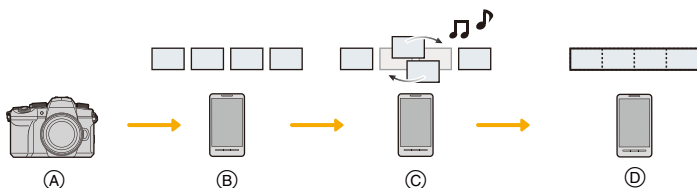

- (A) Record motion pictures with [Snap Movie].
- (B) Send the recorded motion pictures.
- (C) Edit the motion pictures.
- (D) Combine the motion pictures, and save the combined motion picture.



■ Combining motion pictures by operating a smartphone

- 1 Connect to a smartphone. (P262)
- 2 Operate the smartphone.

If the camera is already connected to the smartphone via Bluetooth, select [] → [Remote operation].

(iOS devices)

Depending on the connection status of the smartphone, you may need to change the connected device on the Wi-Fi setup screen. Follow the on-screen message on the smartphone to change the setting.

- 1 Select [].
- 2 Select [].



- Follow the message displayed on the smartphone to send the motion pictures recorded with [Snap Movie] to the smartphone.
- 3 Operate the smartphone to edit the motion pictures.

• Read the [Help] in the “Image App” menu for further details on how to operate.

Displaying pictures on a TV

You can display pictures on a TV that supports DLNA (DMR).

1 Select the menu.

MENU →  [Setup] → [Wi-Fi] → [Wi-Fi Function] → [New Connection] → [Playback on TV]

2 Select [Via Network] or [Direct], and connect. (P285, 286)

3 Select a device you want to connect.

- When the connection is established, the screen is displayed.

4 Take or play back still pictures on this unit.

- Set the menu to terminate the connection.

MENU →  [Setup] → [Wi-Fi] → [Wi-Fi Function] → [Yes]
(You can also terminate the connection by pressing [Wi-Fi].)

- Pictures displayed using the Wi-Fi function cannot be output in 4K resolution. To output them in 4K resolution, connect the camera and TV with an HDMI micro cable. (P293)
- When a TV is connected to the camera, the TV screen may temporarily return to the status before the connection. Pictures are displayed again on the TV if you take or play back pictures.
- The [Effect] and [Sound] settings for slide shows are not applied to the TV.



Not available in these cases:

- Motion pictures and 4K burst files cannot be played back.
- Images displayed on certain screens of the camera (thumbnail display screens, etc.) are not displayed on the TV.
- When [Auto Transfer] in [Bluetooth] is set to [ON], [Wi-Fi Function] is not available.

Sending images from the camera

When sending pictures, first select [New Connection], then select the method of sending pictures.

MENU →  [Setup] → [Wi-Fi] → [Wi-Fi Function] → [New Connection] → [Send Images While Recording] or [Send Images Stored in the Camera]

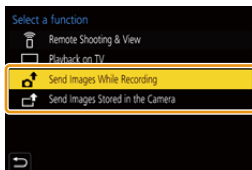

■ Images that can be sent

Destination	JPEG	RAW	MP4 ^{*1}	AVCHD ^{*1,2}	4K Burst File ^{*1} Images recorded with the Post Focus function ^{*1}
[Smartphone]	○	○ ^{*3}	○ ^{*4}	—	—
[PC]	○	○	○	○	○
[AV device]	○	—	—	—	—
[Printer] ^{*1}	○	—	—	—	—

*1 Sending by [Send Images While Recording] is not available.

*2 Cannot be sent if the file size is over 4 GB.

*3 An OS version of Android 7.0 or higher or iOS 10.0 or higher is required.

*4 Excluding 4K motion pictures

- Some images may not be played back or sent depending on the device.
- For details about playback of images, refer to the operating instructions for the destination device.

■ Send Images While Recording

A picture can be automatically sent to a specified device every time you take it.

- While sending a file, [📷] is displayed on the recording screen.
- Set the menu to terminate the connection.

MENU → 🏠 [Setup] → [Wi-Fi] → [Wi-Fi Function] → [Yes]

- You cannot change the sending settings while sending pictures.

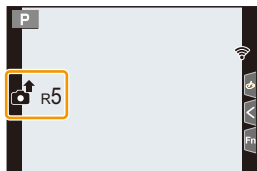

- Since the camera gives priority to recording, sending may take longer during the recording.
- If you turn off the camera or terminate the Wi-Fi connection before the transmission is completed, unsent files will not be resent.
- You may not be able to delete files or use the playback menu while sending.

Not available in these cases:

- If you set [Time Lapse Shot], the Wi-Fi connection is terminated and you cannot use this function.



MENU



■ Send Images Stored in the Camera

Images can be selected and sent after recording.

[Single Select] setting

- 1 Select the picture.
- 2 Select [Set].



[Multi Select] setting

- 1 Select the picture. (repeat)
 - The setting is cancelled when the picture is selected again.
- 2 Select [OK].
 - To close the connection, select [Exit].

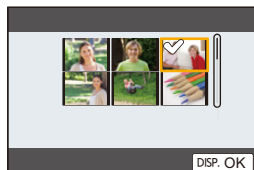

Not available in these cases:

- Images recorded with another device and images modified or edited on a PC may not be sent.

■ Image send settings

Pressing [DISP.] after completing a connection allows you to change the settings for sending such as the image size for sending.

[Size]	Resize the image to send. [Original]/[Change] ([M], [S] or [VGA])
[File Format] (Destination: [Smartphone], [PC])	[JPG]/[RAW+JPG]/[RAW]

Sending images to a smartphone

Preparations:

Install the "Image App" in advance. (P259)

1 Select the menu.

MENU → ⌂ [Setup] → [Wi-Fi] → [Wi-Fi Function] → [New Connection] → [Send Images While Recording] or [Send Images Stored in the Camera] → [Smartphone]

2 Select [Via Network] or [Direct], and connect. (P285, 286)

(On your smartphone)

When connecting with [Via Network]:

- ❶ Turn on the Wi-Fi function.
- ❷ Select the wireless access point.
- ❸ Start "Image App".

When connecting with [WPS Connection] in [Direct]:

- ❶ Start "Image App".
 - Refer to the operating instructions for your smartphone for information about whether it supports WPS.

When connecting with [Manual Connection] in [Direct]:

- ❶ Turn on the Wi-Fi function.
- ❷ Select the SSID that matches the one displayed on the screen of this unit.
- ❸ Start "Image App".

3 Select a device you want to connect.

4 Check the send settings, and select [Set].

• To change the send setting, press [DISP.]. (P279)

5 When [Send Images While Recording] has been selected

Take pictures. (P278)

When [Send Images Stored in the Camera] has been selected

Select the picture. (P279)

Not available in these cases:

• When [Auto Transfer] in [Bluetooth] is set to [ON], [Wi-Fi Function] is not available.

Printing Wirelessly

You can print pictures on printers that support PictBridge (wireless LAN)*.

* Compliant with the DPS over IP standards.

- For details on the PictBridge (wireless LAN-compatible) printer, contact the respective company.

1 Select the menu.

MENU →  [Setup] → [Wi-Fi] → [Wi-Fi Function] → [New Connection] → [Send Images Stored in the Camera] → [Printer]

2 Select [Via Network] or [Direct], and connect. (P285, 286)

3 Select a printer you want to connect.

4 Select pictures, and then print.

- The procedure for selecting pictures is the same as the one for when the USB connection cable is connected. (P303)
- To terminate the connection, press .
(You can also terminate the connection by pressing [Wi-Fi].)

Not available in these cases:

- When [Auto Transfer] in [Bluetooth] is set to [ON], [Wi-Fi Function] is not available.

Sending images to AV device

You can send pictures and motion pictures to an AV device (home AV device) that supports DLNA, such as a recorder.

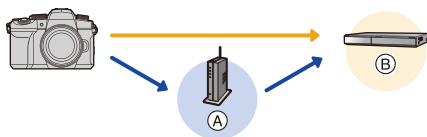

(A) Wireless access point

(B) Home AV device

1 Select the menu.

MENU → [Setup] → [Wi-Fi] → [Wi-Fi Function] → [New Connection] → [Send Images While Recording] or [Send Images Stored in the Camera] → [AV device]

2 Select [Via Network] or [Direct], and connect. (P285, 286)

3 Select a device you want to connect.

4 Check the send settings, and select [Set].

- To change the send setting, press [DISP.]. (P279)

5 When [Send Images While Recording] has been selected

Take pictures. (P278)

When [Send Images Stored in the Camera] has been selected

Select the picture. (P279)

- Sending may fail depending on the operational status of the AV device. Also, sending may take a while.

Not available in these cases:

- When [Auto Transfer] in [Bluetooth] is set to [ON], [Wi-Fi Function] is not available.

Sending images to PC

Preparations:

- Turn the computer on.
- Prepare folders for receiving images on the PC. (P283)
- If the workgroup of the destination PC has been changed from the standard setting, change the setting of this unit in [PC Connection]. (P291)

■ To create a folder that receives images

- Create a PC account name (up to 254 characters) and password (up to 32 characters) consisting of alphanumeric characters. An attempt to create a receive folder may fail if the account name includes non-alphanumeric characters.

When using "PHOTOfunSTUDIO"

- 1 Install "PHOTOfunSTUDIO" to the PC. (P298)
- 2 Create a folder that receives images with "PHOTOfunSTUDIO".
 - For details, refer to the operating instructions of "PHOTOfunSTUDIO" (PDF).

When not using "PHOTOfunSTUDIO"

(For Windows)

Supported OS: Windows 10/Windows 8.1/Windows 8/Windows 7

Example: Windows 7

- 1 Select a folder you intend to use for receiving, then right-click.
- 2 Select [Properties], then enable sharing of the folder.
 - For details, refer to the operating instructions of your PC or Help on the OS.

(For Mac)

Supported OS: OS X v10.5 to v10.11, macOS 10.12 to 10.14

Example: OS X v10.8

- 1 Select a folder you intend to use for receiving, then click on the items in the following order.
[File] → [Get Info]
- 2 Enable sharing of the folder.
 - For details, refer to the operating instructions of your PC or Help on the OS.

■ Sending images to the PC

1 Select the menu.

MENU →  [Setup] → [Wi-Fi] → [Wi-Fi Function] → [New Connection] → [Send Images While Recording] or [Send Images Stored in the Camera] → [PC]

2 Select [Via Network] or [Direct], and connect. (P285, 286)

3 Enter the computer name of the PC (NetBIOS name for Mac) you want to connect to.

4 Select the folder you want to send.

5 Check the send settings, and select [Set].

- To change the send setting, press [DISP.]. (P279)

6 When [Send Images While Recording] has been selected

Take pictures. (P278)

When [Send Images Stored in the Camera] has been selected

Select the picture. (P279)

- Folders sorted by sent date will be created in the destination folder, and images will be saved there.
- If the screen for a user account and password entry appears, enter the one you set on your PC.
- When the computer name (NetBIOS name for Mac) contains a space (blank character), etc., it may not be recognised.
In that case, we recommend changing the name to one consisting only of 15 or less alphanumeric characters.
- When the firewall of the OS, security software, etc. is enabled, connecting to the PC may not be possible.

Not available in these cases:

- When [Auto Transfer] in [Bluetooth] is set to [ON], [Wi-Fi Function] is not available.

Wi-Fi connections

The following types of connections are available.

MENU →  **[Setup]** → **[Wi-Fi]** → **[Wi-Fi Function]**

[New Connection]

This makes a connection after a Wi-Fi function and send destination is selected. When a screen similar to the one below is displayed, select the connection method.

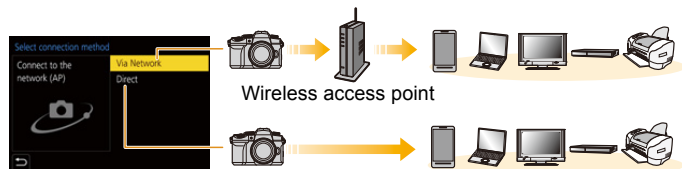

- [Via Network] (P286):
Makes a connection via a wireless access point.
- [Direct] (P288):
Connects your device and the camera directly.

[Select a destination from History]/ [Select a destination from Favorite]

Connection is made using the same settings as the previous time. (P289)

[Via Network]

Select a connection method to the wireless access point.

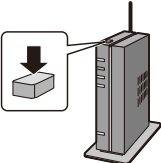
[WPS (Push-Button)]	<p>Save push button type wireless access point that is compatible with Wi-Fi Protected Setup™ with a WPS mark.</p> <p>Press the wireless access point WPS button until it switches to WPS mode. e.g.:</p> 
[WPS (PIN code)]	<p>Register a PIN code type wireless access point with a WPS mark that supports Wi-Fi Protected Setup.</p> <ol style="list-style-type: none"> 1 Select the wireless access point on the camera. 2 Enter the PIN code displayed on the camera screen into the wireless access point. 3 Press [MENU/SET] of the camera.
[From List]	<p>Select this option when you are not sure about the WPS compatibility, or when you want to search for and connect to a wireless access point. (P287)</p>

- Except for the first-time connection, the camera will connect to the previously-used wireless access point.
To change the connection destination, press [DISP].
- WPS refers to a function that allows you to easily configure the settings related to the connection and security of wireless LAN devices.
Refer to the operating instructions for the wireless access point for details about how to operate the WPS function and whether it is supported.

[From List]

Search for available wireless access points.

- Confirm encryption key of the wireless access point if the network authentication is encrypted.

1 Select the wireless access point.

- To search for wireless access points again, press [DISP.].
- If no wireless access point is found, refer to “Connecting by Manual Input” on [P287](#).

2 (If network authentication is encrypted)**Enter the encryption key.**

- For information on how to enter characters, refer to [P64](#).

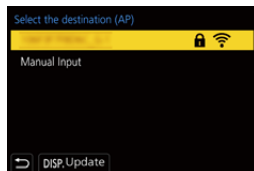
**■ Connecting by Manual Input**

- Check the SSID, network authentication type, encryption type, and encryption key of the wireless access point to be connected.

- 1 On the screen displayed in step **1** of “[From List]”, select [Manual Input].
- 2 Enter the SSID of the wireless access point you are connecting to, then select [Set].
 - For information on how to enter characters, refer to [P64](#).
- 3 Select the network authentication type.

[WPA2-PSK]	Supported encryption methods: [TKIP], [AES]
[WPA2/WPA-PSK]	
[No Encryption]	—

- 4 (When an option other than [No Encryption] is selected)
Enter the encryption key.

- Check the wireless access points instruction manual and settings when saving a wireless access point.
- If no connection can be established, the wireless access point's radio waves may be too weak.
Refer to “Message Display” ([P318](#)) and “Troubleshooting” ([P321](#)) for details.
- Depending on your environment, transmission speed between the camera and wireless access point may decrease. In addition, the wireless access point may not be available for use.

[Direct]

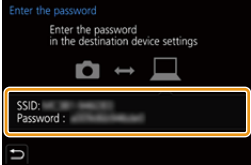
[WPS Connection]	[WPS (Push-Button)] 1 On the camera, select [WPS (Push-Button)]. 2 Set the device to WPS mode. <ul style="list-style-type: none"> You can wait longer for a connection by pressing [DISP.] on this unit.
	[WPS (PIN code)] 1 On the camera, select [WPS (PIN code)]. 2 Enter the PIN code of the device into this camera.
[Manual Connection]	Enter the SSID and password displayed on the camera. <ul style="list-style-type: none"> The password will not be displayed when [Wi-Fi Password] is set to [OFF] and the device to be connected is set to [Smartphone]. Select the SSID to connect. (P262) 

- Please also refer to the operating instructions of the device to be connected.

Connect to Wi-Fi Using Previously Saved Settings

Wi-Fi connection history is saved in History when the Wi-Fi function is used. Connecting from History allows you to easily connect with the same Wi-Fi settings as used previously.

- If the settings of the device to connect to have been changed, it may not be possible to connect to the device.

1 Select the menu.

MENU → ⌘ [Setup] → [Wi-Fi] → [Wi-Fi Function]

[Select a destination from History]

Connects with previously-used settings.

[Select a destination from Favorite]

Connects with settings registered as favourites.

2 Select item.

- You can display details of the connection by pressing [DISP].

■ Register to favourite

1 Select the menu.

MENU → ⌘ [Setup] → [Wi-Fi] → [Wi-Fi Function] →
[Select a destination from History]

2 Select the item you wish to register and press ►.

3 Enter a registration name.

- For information on how to enter characters, refer to [P64](#).
- A maximum of 30 characters can be entered. A two-byte character is treated as two characters.

■ Editing items registered in favourite

- 1 Select the menu.

MENU →  **[Setup]** → **[Wi-Fi]** → **[Wi-Fi Function]** →
[Select a destination from Favorite]

- 2 Select the Favourites item you wish to edit and press ►.

[Remove from Favorite]	—
[Change the Order in Favorite]	Select the destination.
[Change the Registered Name]	• How to enter text (P64)

- Because the number of items that can be saved in History is limited, register frequently-used connection settings to Favourites.
- Performing [Reset Network Settings] deletes data registered in History and Favourites.
- If the device you want to connect to (smartphone, etc.) is connected to a wireless access point other than the camera, you cannot connect the device to the camera using [Direct]. Change the Wi-Fi settings of the device you want to connect to so that the access point to be used is set to the camera.
 You can also select [New Connection] and reconnect the devices. [\(P259\)](#)
- It may be difficult to establish a connection to a network used by many devices. In that case, connect by [New Connection].

[Wi-Fi Setup] Menu

Configure the settings required for the Wi-Fi function.
The settings cannot be changed when connected to Wi-Fi.

MENU →  **[Setup]** → **[Wi-Fi]** → **[Wi-Fi Setup]**

[Priority of Remote Device]

This sets the higher priority between the camera and smartphone to perform operations during remote recording. (P267)

[Wi-Fi Password]

You can improve security by enabling password entry for a direct connection to a smartphone.

[ON]	Connects the camera and a smartphone using an SSID and password. (P263)
[OFF]	Connects the camera and a smartphone using an SSID. (P262)

• When [ON] is selected, you can also set up a connection by scanning a QR code.

[PC Connection]

You can set the workgroup.

To send images to a PC, a connection to the same workgroup as the destination PC is required.

(The default setting is "WORKGROUP".)

- ❶ Press [MENU/SET].
 - ❷ Enter the workgroup of the connecting PC.
 - For information on how to enter characters, refer to P64.
- To reset to the default setting, press [DISP].

[Device Name]

You can change the name (SSID) of this unit.

- ❶ Press [DISP.].
- ❷ Enter the desired device name.
 - For information on how to enter characters, refer to P64.
 - A maximum of 32 characters can be entered.

[Wi-Fi Function Lock]

To prevent incorrect operation and use of the Wi-Fi function by a third party and to protect saved personal information, we recommend protecting the Wi-Fi function with a password.

[Setup]	Enter any 4-digit numbers as the password. • For information on how to enter characters, refer to P64 .
[Cancel]	Cancel the password.

- Once a password is set, you are required to enter it each time you use the Wi-Fi function.
- If you forget the password, you can reset it with [Reset Network Settings] in the [Setup] menu.

[Network Address]

Displays the MAC address and IP address of this unit.

- A MAC Address is a unique address that is used to identify network equipment.
- IP address refers to a number that identifies a PC connected to a network such as the Internet. Usually, the addresses for homes are automatically assigned by the DHCP function such as a wireless access point. (Example: 192.168.0.87)

Watching/Saving 4K Motion Pictures on an External Device

Watching motion pictures in 4K

■ Playing Back on a TV Screen

You can enjoy finely-detailed 4K motion pictures by connecting the camera and a TV that supports 4K motion picture and playing back 4K motion pictures recorded with the camera. Although the output resolution will be lower, you can also play them back by connecting to a device that does not support 4K motion picture, such as a high-definition TV.

Preparation:

- Set [HDMI Mode (Play)] (P234) to [AUTO] or a resolution of [4K/25p].
- When connecting to a TV that does not support 4K motion picture, select [AUTO].



Connect the camera and a 4K-compatible TV with an HDMI micro cable, and display the playback screen. (P294)

- The TV input will switch automatically and the playback screen will be displayed when you set [VIERA Link] to [ON] and connect to a VIERA Link compatible TV. Refer to P296 for details.
- Read the operating instructions for the TV.

■ Watching on a PC

To play back 4K motion pictures on a PC, use the software "PHOTOfunSTUDIO".

- To play back and edit motion pictures in 4K, you need a high-performance PC environment.
- Refer to the operating instructions of "PHOTOfunSTUDIO" (PDF).



Storing 4K motion pictures

■ Storing on a PC

Use the software "PHOTOfunSTUDIO" to import 4K motion pictures to a PC.

- Refer to the operating instructions of "PHOTOfunSTUDIO" (PDF).

Playing Back Pictures on a TV Screen

Preparations: Turn off the camera and TV.

1 Connect the camera and the TV with an HDMI micro cable.

- Check the direction of the terminals and plug in/out straight holding onto the plug. (It may result in malfunction by the deforming of the terminal if it is plugged in obliquely or in wrong direction.)

Do not connect devices to incorrect terminals. Doing so may cause malfunction.

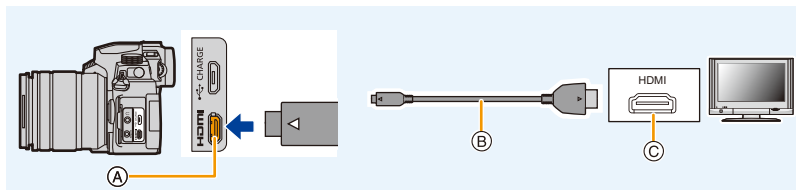

(A) [HDMI] socket

(C) HDMI socket (on the TV)

(B) HDMI micro cable

- Use a “High Speed HDMI micro cable” with the HDMI logo. Cables that do not comply with the HDMI standards will not work. “High Speed HDMI micro cable” (Type D–Type A plug, up to 2 m (6.6 feet) long)

2 Turn on the TV and select the input to match the connector in use.

3 Turn the camera on and then press [▶].

- Depending on the [Aspect Ratio], black bands may be displayed on the top and bottom or the left and right of the pictures.
- Change the screen mode on your TV if the picture is displayed with the top or bottom cut off.
- Check the [HDMI Mode (Play)]. (P234)
- To play back 24p motion pictures, set [HDMI Mode (Play)] to [AUTO]. Otherwise, the picture is not output at 24 frames per second.
- Depending on the TV to be connected, 4K burst files may not be played back correctly.
- No image will be displayed on the monitor/viewfinder of the camera. In addition, no audio will be output from the speaker of the camera.
- HDMI output will be cancelled if a USB connection cable (supplied) is connected simultaneously.
- Read the operating instructions for the TV.

Recording while monitoring camera images

When using the HDMI output, you can record pictures and motion pictures while monitoring the camera image on an external monitor, TV or similar device.

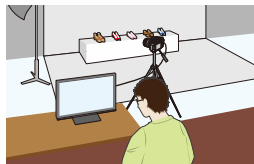

■ Setting the information display during HDMI output

Select whether or not to output the information display of the camera to an external device connected via HDMI.

MENU → **[Setup]** → **[TV Connection]** → **[HDMI Info Display (Rec)]**

Settings: [ON]/[OFF]

- When using the HDMI output during recording, the image quality is automatically switched in accordance with the connecting device. However, in the following cases, images will be output in accordance with the [Rec Quality] in the menu. (If the setting is not supported by the connecting device, the camera will switch the image quality in accordance with the device.)
 - When recording motion pictures
 - In Creative Video Mode
 - When [Rec Area] is set to []
- [Aspect Ratio] in the [Rec] menu is fixed to [16:9].
- If the camera is connected to an external monitor or TV that supports 4K motion picture, using the following settings will cause the angle of view to become even narrower than usual:
 - [4K/100M/30p]/[4K/100M/25p]/[4K/100M/24p] in [Rec Quality]
 - [4K Live Cropping]
- When [] is selected for the AF Mode or during MF Assist, the enlarged display is not output.
- Ex. Tele Conv. (motion picture) does not work (excluding Creative Video Mode).
- Electronic sounds and electronic shutter sounds are muted.
- When you check the image and sound from the TV connected to the camera, the microphone of the camera may pick up the sound from the speakers of the TV, producing an abnormal sound (audio feedback). If this occurs, move the camera away from the TV or lower the volume on the TV.
- If you connect to a Wi-Fi network during HDMI output, no image will be displayed on the monitor of the camera.
- Some setting screens are not output via HDMI.
- There is no output via HDMI in the following cases:
 - During panorama picture recording
 - When recording 4K photos
 - When recording with the Post Focus function

Using VIERA Link (HDMI)

What is the VIERA Link (HDMI) (HDAVI Control™)?

- This function allows you to use your remote control for the Panasonic TV for easy operations when this unit has been connected to a VIERA Link compatible device using an HDMI micro cable for automatic linked operations.
(Not all operations are possible.)
- VIERA Link is a unique Panasonic function built on an HDMI control function using the standard HDMI CEC (Consumer Electronics Control) specification.
Linked operations with HDMI CEC compatible devices made by other companies are not guaranteed. When using devices made by other companies that are compatible with VIERA Link, refer to the operating instructions for the respective devices.
- This unit supports “VIERA Link Ver.5” function. “VIERA Link Ver.5” is the standard for Panasonic’s VIERA Link compatible equipment. This standard is compatible with Panasonic’s conventional VIERA Link equipment.

Preparations:

MENU →  [Setup] → [TV Connection] → [VIERA Link] → [ON]

- 1 **Connect this unit to a Panasonic TV compatible with VIERA Link with an HDMI micro cable (P294).**
- 2 **Turn the camera on and then press .**
- 3 **Operate with the remote control for the TV.**

Turning this unit off:

If you use the remote control for the TV to turn the TV off, this unit is also turned off.

Automatic input switching:

- If you connect with an HDMI micro cable and then turn this unit on, and then press , the input channel on the TV automatically switches to this unit’s screen. If the TV’s power is in standby status, it will turn on automatically (if [Set] has been selected for the TV’s [Power on link] setting).
- Operation using the buttons on this unit will be limited.
- To play back the sound of a film during a slide show, set [Sound] to [AUTO] or [Audio] on the Slide Show setting screen.
- Use a “High Speed HDMI micro cable” with the HDMI logo.
Cables that do not comply with the HDMI standards will not work.
“High Speed HDMI micro cable” (Type D–Type A plug, up to 2 m (6.6 feet) long)
- Refer to [P328](#) if VIERA Link is not operating correctly.

Importing images to a PC

You can acquire recorded pictures to a PC by connecting the camera and the PC.

- Some PCs can read directly from the card removed from the camera. For details, refer to the operating instructions of your PC.

■ PC that can be used

The unit can be connected to any PC capable of recognising a mass storage device.

- Windows support: Windows 10/Windows 8.1/Windows 8/Windows 7
- Mac support: OS X v10.5 to v10.11, macOS 10.12 to 10.14



AVCHD motion pictures may not be imported correctly when copied as files or folder

- When using Windows, import AVCHD motion pictures with “PHOTOfunSTUDIO”.
- When using Mac, you can copy motion pictures recorded in [AVCHD] using “iMovie”.
Note, however, that it may not be possible to copy pictures depending on the picture quality settings.

(For details about iMovie, please contact Apple Inc.)

Downloading software

- To download the software, you need to connect the PC to the Internet.
- It may take some time to download the software depending on the communication environment.
- Supported OSs are current as of April 2022 and are subject to change.

PHOTOfunSTUDIO 10.0 AE

This software allows you to manage images. For example, you can send pictures and motion pictures to a PC and sort them by recording date or model name. You can also perform operations such as writing images to a DVD, processing and correcting images, and editing motion pictures.

Check the site below to download and install the software.

Download the software while it is available for download.

- Download expiration: July 2025

https://panasonic.jp/support/global/cs/soft/download/d_pfs10ae.html

(This Site is English only.)

- Operating environment

OS	Windows® 10 (32bit/64bit), Windows® 8.1 (32bit/64bit) • For 4K motion pictures and 4K photos, a 64 bit OS version of Windows 10 / 8.1 is required.
CPU	Pentium® 4 (2.8 GHz or higher)
Display	1024×768 pixels or more (1920×1080 pixels or more recommended)
RAM	1 GB or more (32bit), 2 GB or more (64bit)
Free hard disk space	450 MB or more for installing software

- Refer to the operating instructions for "PHOTOfunSTUDIO" (PDF file) for details about the operating environment required to use the playback and editing functions for 4K motion pictures and the picture cropping function for 4K photos.
- "PHOTOfunSTUDIO" is not compatible with Mac.

SILKYPIX Developer Studio SE

This is software to edit RAW format images.

Edited images can be saved in a format (JPEG, TIFF, etc.) that can be displayed on a personal computer.

Check the site below to download and install the software.

<http://www.isl.co.jp/SILKYPIX/english/p/>

- Operating environment

OS	Windows® 10, Windows® 8.1 (64-bit recommended)
	macOS 10.13 to macOS 10.15, macOS 11

- For details on how to use the “SILKYPIX Developer Studio”, refer to the Help or the Ichikawa Soft Laboratory’s support website.

LoiLoScope 30 day full trial version

(Windows 10 / 8.1 / 8)

This software allows you to edit motion pictures with ease.

Check the site below to download and install the software.

<http://loilo.tv/product/20>

- For more information about the operating environment of and how to use LoiLoScope, download the LoiLoScope manual available for download at the website.
- “LoiLoScope” is not compatible with Mac.

Copying images to a PC

Preparations:

Install "PHOTOfunSTUDIO" on PC. (P298)

1 Turn on the camera and the PC, and then connect these with the USB connection cable (supplied).

- Check the direction of the terminals and plug in/out straight holding onto the plug. (It may result in malfunction by the deforming of the terminal if it is plugged in obliquely or in wrong direction.)
Do not connect devices to incorrect terminals. Doing so may cause malfunction.
- Do not use any other USB connection cables except the supplied one.

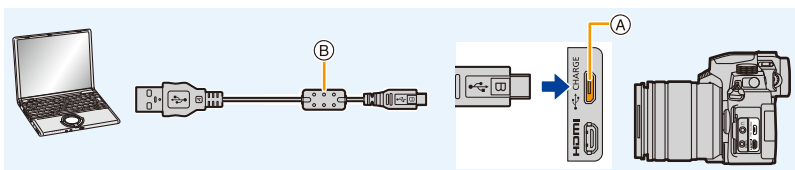

- (A) [USB/CHARGE] socket
- (B) USB connection cable (supplied)

2 Press ▲/▼ to select [PC(Storage)], and then press [MENU/SET].

- If [USB Mode] is set to [PC(Storage)] in the [Setup] menu in advance, the camera will be automatically connected to the PC without displaying the [USB Mode] selection screen.
- A message about charging may be displayed. Wait until the display disappears.

3 Copy the images to a PC using "PHOTOfunSTUDIO".

- Do not delete or move copied files or folders in Windows Explorer.
When viewing in "PHOTOfunSTUDIO", you will not be able to play back or edit.

- Before removing or inserting the card, turn off the camera and disconnect the USB connection cable. Otherwise, damage may be caused to the recorded data.
- Use a sufficiently charged battery, or the AC adaptor (optional) and the DC coupler (optional).
- If the remaining battery power becomes low while the camera and the PC are communicating, the alarm beeps.
Disconnect the USB connection cable safely. Otherwise, damage may be caused to the recorded data.

■ Folder structure inside card

You can drag and drop the folders and files containing the images you want to transfer into separate folders on your PC to save them.

For Windows: A drive ([LUMIX]) is displayed in [Computer]

For Mac: A drive ([LUMIX]) is displayed on the desktop

Card

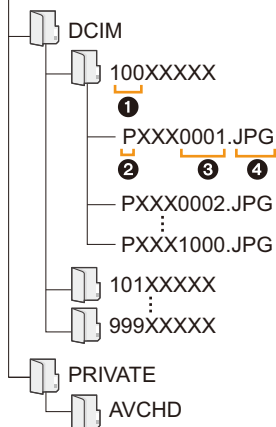

DCIM: Still/motion pictures

- ❶ Folder number
- ❷ Colour space P: sRGB
_: AdobeRGB
- ❸ File number
- ❹ JPG: Still pictures
RW2: Pictures in RAW files
MP4: [MP4] Motion pictures
4K burst file

AVCHD: Motion pictures in AVCHD

Storing on a Recorder

You can connect the camera to a Panasonic Blu-ray disc recorder or DVD recorder and store pictures and motion pictures on it.

Preparations:

Turn on the camera and the recorder.

1 Connect the recorder and camera with the USB connection cable (supplied).

- Check the direction of the terminals and plug in/out straight holding onto the plug. (It may result in malfunction by the deforming of the terminal if it is plugged in obliquely or in wrong direction.)
Do not connect devices to incorrect terminals. Doing so may cause malfunction.
- Do not use any other USB connection cables except the supplied one.

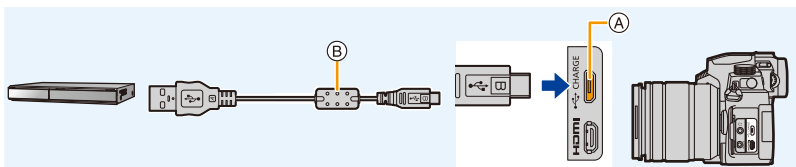

- (A) [USB/CHARGE] socket
- (B) USB connection cable (supplied)

2 Press **▲/▼** to select [PC(Storage)], and then press [MENU/SET].

- If you set the [USB Mode] to [PC(Storage)] in the [Setup] menu, the [USB Mode] selection screen will not be displayed and the camera will automatically connect to the recorder.
- A message about charging may be displayed. Wait until the display disappears.

3 Operate the recorder to copy.

- See the operating instructions for the recorder about the details about copying and playing back.
 - Modes such as 4K motion picture may not be supported depending on the recorder being used.
- Use a sufficiently charged battery or an AC adaptor (optional) and DC coupler (optional). If the remaining battery power becomes low while the camera and the recorder are communicating, the alarm beeps. In that case, cancel copying immediately. Otherwise, damage may be caused to the data.
 - Before removing or inserting the card, turn off the camera and disconnect the USB connection cable. Otherwise, damage may be caused to the recorded data.

Printing the Pictures

You can directly connect the camera to a PictBridge-supported printer for printing.

Preparations:

- Perform the print quality and other settings at the printer before printing the pictures.
- Turn on the camera and the printer.

1 Connect the printer and camera with the USB connection cable (supplied).

- Check the direction of the terminals and plug in/out straight holding onto the plug. (It may result in malfunction by the deforming of the terminal if it is plugged in obliquely or in wrong direction.)
Do not connect devices to incorrect terminals. Doing so may cause malfunction.
- Do not use any other USB connection cables except the supplied one.

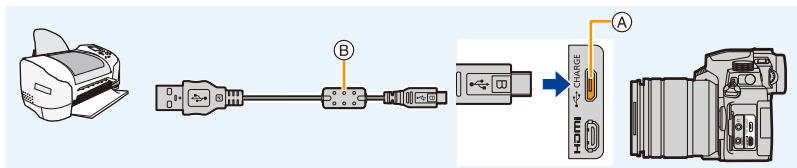

(A) [USB/CHARGE] socket

(B) USB connection cable (supplied)

- Do not disconnect the USB connection cable while [] (Cable disconnect prohibit icon) is displayed.
(May not be displayed depending on the type of printer used.)

2 Press ▲/▼ to select [PictBridge(PTP)], and then press [MENU/SET].

- A message about charging may be displayed. Wait until the display disappears.

3 Press ◀/▶ to select the picture and then press [MENU/SET].

4 Press ▲/▼ to select [Print start] and then press [MENU/SET].

Selecting multiple pictures and printing them

- 1 Press **▲** to select the multiple printing setting in step 3 of “Printing the Pictures”. (P303)
- 2 Press **▲/▼** to select an item and then press **[MENU/SET]**.

[Multi Select]	Multiple pictures are printed at one time. <ul style="list-style-type: none"> • Press ▲/▼/◀/▶ to select the pictures and then press [MENU/SET]. (Press [MENU/SET] again to cancel the setting.) • After the pictures have been selected, press [DISP.].
[Select All]	Prints all the stored pictures.
[Rating]	Prints all images with [Rating] levels between [★1] and [★5].

- 3 Press **▲/▼** to select **[Print start]** and then press **[MENU/SET]**.

- Group pictures will not be displayed as group pictures but as single pictures.
- Disconnect the USB connection cable after printing.
- Use a sufficiently charged battery or an AC adaptor (optional) and DC coupler (optional). If the remaining battery power becomes low while the camera and the printer are connected, the alarm beeps. If this happens during printing, stop printing at once. If not printing, disconnect the USB connection cable.
- Before removing or inserting the card, turn off the camera and disconnect the USB connection cable. Otherwise, damage may be caused to the recorded data.
- Some printers can print directly from the card removed from the camera. For details, refer to the operating instructions of your printer.
- The camera is receiving an error message from the printer when the **[●]** indication lights yellow during printing. After finishing printing, make sure there are no problems with the printer.
- If the number of prints is high, the pictures may be printed several times. In this case, the remaining number of prints indicated may differ from the number set.
- When you print RAW images, JPEG images that were recorded at the same time will be printed. If JPEG images were not recorded, printing is not possible.



Not available in these cases:

- Motion pictures, 4K burst files, and images recorded with the Post Focus function cannot be printed.

■ Making print settings on the camera

Setting options include the number of printed pictures and their size. Make settings before selecting [Print start].

[Print with Date]	[ON]/[OFF]
[Num.of prints]	Sets number of pictures (up to 999 pictures).
[Paper Size]	Sets the paper size.
[Page Layout]	Sets whether or not to add borders and how many pictures to be printed on each sheet of paper.

- If the printer does not support date printing, the date cannot be printed on the picture.
- Depending on the printer, the date print settings of the printer may take precedence so check if this is the case.
- Items not supported by the printer are not displayed.
- When you want to print pictures on a paper size or a layout which is not supported by the camera, set [Paper Size] or [Page Layout] to [A] and then set the paper size or the layout on the printer.
(For details, refer to the operating instructions of the printer.)

Adding date and text to pictures

You can use [Text Stamp] in the [Playback] menu to stamp date and time on pictures.

■ Printing date without using [Text Stamp]

In-store printing:

Only recording date can be printed. Order date printing at a store.

The characters entered using the following menus cannot be printed at a store.

- [Age] and [Name] in [Face Recog.] or [Profile Setup]
- [Location] in [Travel Date]
- [Title Edit]

Printing at home:

When using a printer that supports date printing, you can print recording date and time by setting [Print with Date] (P305) to [ON].

You can use the software "PHOTOfunSTUDIO" to set the print settings for recording date and text information.

12. Others

Optional accessories

- Some optional accessories may not be available in some countries.

External Flash (optional)

After attaching the flash (DMW-FL580L, DMW-FL360L, DMW-FL200L: optional), the effective range will be increased when compared to the camera's built-in flash.

Preparations:

- Close the built-in flash and set the camera on/off switch to [OFF].

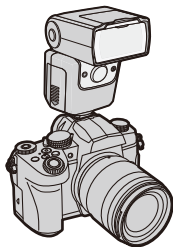

Removing the Hot Shoe Cover

The camera comes with a hot shoe cover attached to the hot shoe.

Remove the hot shoe cover by pulling it in the direction indicated by arrow ② while pressing it in the direction indicated by arrow ①.

- Keep the Hot Shoe Cover out of reach of children to prevent swallowing.

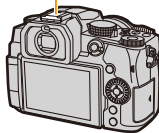
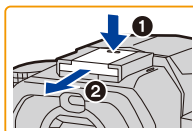

- To change the settings for external flashes on the camera, refer to [P161](#).
- Refer to [P166](#) about the settings for the wireless flash.



When using other commercially available external flashes without communication functions with the camera

- It is necessary to set the exposure on the external flash. If you want to use the external flash in Auto Mode, use an external flash that allows you to set the aperture value and the ISO sensitivity to match the settings on the camera.
- Set to Aperture-Priority AE Mode or Manual Exposure Mode on the camera and then set the same aperture value and ISO sensitivity on the external flash. (The exposure cannot be compensated adequately due to the change on the aperture value in Shutter-Priority AE Mode and the external flash cannot control the light adequately in Programme AE Mode because the aperture value cannot be fixed.)

- If you attach an external flash, you can use the following functions even when recording with the flash:
 - Aperture Bracket
 - Focus Bracket
- You can set the aperture value, the shutter speed and the ISO sensitivity on the camera even when attaching the external flash.
- If you record at close range with a wide angle, light from the flash may be blocked by the lens, darkening the lower part of the screen.
- When using a commercially available external flash, do not use one with reversed polarity or function for communicating with a camera.
 - It may cause the camera to malfunction, or it may not operate correctly.
- When attaching the external flash, do not hold only the external flash because it may detach from the camera.
- Read the operating instructions of the external flash for details.

Battery Grip (optional)

When mounted on the camera, the Battery Grip (DMW-BGG1: optional) improves ease of operation and grip when the camera is held vertically.

Also, inserting a battery into the Battery Grip provides a stable supply of power even for long periods of recording.

A Battery Grip (DMW-BGG1: optional) is supplied with a battery pack (DMW-BLC12).

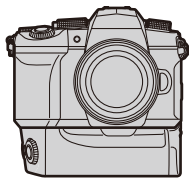

■ Battery Grip button operations

When the Battery Grip is attached to the camera, the Battery Grip buttons operate as follows:

- A**  (Exposure compensation) button/[Fn] button:
Operates as the exposure compensation button.
- B** Function button:
Operates the same as the Fn button (Fn1).

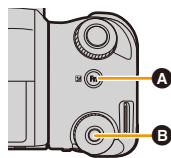

■ Selecting battery usage priority

Preparations:

- Turn the camera off, and remove the cover for the Battery Grip connector.

- 1 Attach the Battery Grip to the camera.
- 2 Turn on the camera.
- 3 Select the menu.

MENU →  **[Setup]** → **[Battery Use Priority]**

[BODY]: The battery in the camera is used first.

[BG]: The battery in the Battery Grip is used first.

- When the battery in the Battery Grip is used, **[BG]** is displayed on the screen.
- When the cover for the Battery Grip connector is difficult to remove, move the corner of the camera with a groove towards the centre when removing.
- Read the operating instructions of the Battery Grip for details.

■ Shutter Remote Control (optional)

When connected to the [REMOTE] socket on the camera, the Shutter Remote Control (DMW-RS2: optional) can be used for the following purposes:

- Fully pressing the shutter button without camera shake
- Securing the shutter button during bulb recording and burst recording
- Start/end the motion picture recording



■ Shutter Remote Control Motion picture button

You can disable the Motion picture button when not recording a motion picture to prevent erroneous operation.

MENU →  **[Custom]** →  **[Operation]** → **[Video Rec. Button (Remote)]**

Settings: [ON]/[OFF]

- Read the operating instructions of the Shutter Remote Control for details.

Not available in these cases:

- You cannot use the Shutter Remote Control for the following operation.
 - Cancelling [Sleep Mode], [Sleep Mode(Wi-Fi)] or [Power Save LVF Shooting]

External Microphone (optional)

Using a Stereo Shotgun Microphone (DMW-MS2: optional) or stereo microphone (VW-VMS10: optional), you can record sounds with quality superior to those recorded with the built-in microphone.

Preparations:

- Close the built-in flash and set the camera on/off switch to [OFF].

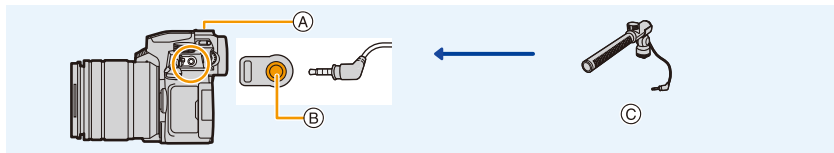

- (A) Hot shoe
- (B) [MIC] socket
- (C) Stereo Shotgun Microphone (DMW-MS2: optional)
Stereo microphone (VW-VMS10: optional)

- Do not use the stereo microphone cables with the length of 3 m (9.8 feet) or more.
- When attaching to the camera, remove the hot shoe cover. (P306)

■ [Special Mic.]

When the Stereo Shotgun Microphone (DMW-MS2: optional) is attached, you can set the microphone sound pickup range in [Special Mic.].

- 1 Attach the Stereo Shotgun Microphone to the camera.
- 2 Turn on the camera.
- 3 Select the menu.

MENU → **[Motion Picture]** → **[Special Mic.]**

[STEREO]	Allows stereo recording of sound over a wide area.
[LENS AUTO]	Picks up sound from a range that matches the lens angle of view.
[SHOTGUN]	Allows recording from one direction by shutting out background and surrounding noise.
[S.SHOTGUN]	Picks up sound from a specific direction narrower than the range of [SHOTGUN].
[MANUAL]	Picks up sound from a manually set range.

- 4 (When [MANUAL] is selected)
Press ◀/▶ to select a range, and press [MENU/SET].

■ [Wind Cut]

This can reduce wind noise when an external microphone is being used.

MENU →  [Motion Picture] → [Wind Cut]

Settings: [HIGH]/[STANDARD]/[LOW]/[OFF]

- This is available when an external microphone is connected.
 - Setting [Wind Cut] may alter the usual sound quality.
- While the external microphone is connected, [] is displayed on the screen.
 - When the external microphone is connected, [Sound Rec Level Disp.] is automatically set to [ON], and the sound rec level is displayed on the screen.
 - When an external microphone is attached to the camera, do not hold only the external microphone to prevent the camera from falling.
 - When an external microphone is attached to the camera, do not open the built-in flash.
 - If the noises are recorded when you use an AC adaptor (optional), use a battery.
 - When a stereo microphone (VW-VMS10: optional) is used, [Special Mic.] is fixed to [STEREO].
 - When [Special Mic.] is set to [LENS AUTO], [S.SHOTGUN] or [MANUAL], [Sound Output] in the [Motion Picture] menu is fixed to [REC SOUND].
 - When [Special Mic.] is set to [MANUAL], you can use the Fn button function [Mic. Directivity Adjust]. Press the set Fn button to display the range setting screen.
 - For details, refer to the operating instructions of the external microphone.

AC adaptor (optional)/DC coupler (optional)

By using the AC adaptor (optional) and DC coupler (optional), you can record and play back without worrying about the remaining battery charge.

The optional DC coupler can only be used with the designated Panasonic AC adaptor (optional).

- Always use a genuine Panasonic AC adaptor (optional).
- When using an AC adaptor (optional), use the AC cable supplied with the AC adaptor.
- **When the DC coupler is being mounted, the DC coupler cover opens, so the structure ceases to be dust and splash resistant.**
Be careful not to allow sand, dust and water etc. to adhere to or enter the structure. After use, check that there is no foreign matter attached to the DC coupler cover, and close it firmly.
- For details, refer to the operating instructions of the AC adaptor and DC coupler.

Monitor Display/Viewfinder Display

Display example: When [] (monitor style) is set and the monitor display is in use

- The information displayed, such as histograms, magnifications, and numeric values, are only for the purpose of reference.

In recording

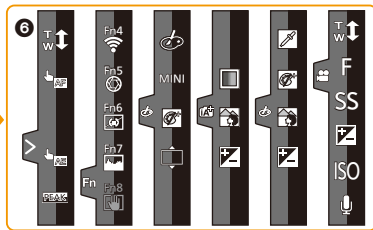
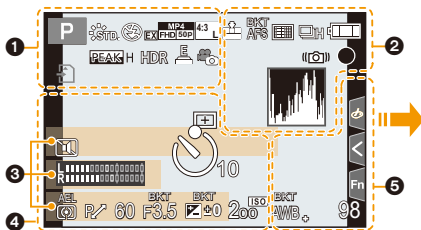

1

	Recording Mode (P44)
C 1	Custom settings (P80)
	Motion picture recording mode (P169)
	Photo Style (P196)
	Flash Mode (P162)
	Flash (P164, 167)
	Extra Tele Conversion (when recording motion pictures) (P154)
	Recording format/Recording quality (P171)
	Snap Movie (P176)
	Aspect Ratio (P194)/Picture size (P194)
	Extra Tele Conversion (when taking still pictures) (P154)
	Image size ([Panorama Settings])
	Image effect (filter) adjustment display (P90, 199)
EXPS	Image effect (filter) setting (P199)
	Loop Recording (P124)

	Card (displayed only during recording) (P31)
8m30s	Elapsed recording time*1 (P169)
	Simultaneous recording indicator (P175)
	Automatic viewfinder/monitor switching (P42)
	Peaking (P220)
	Highlight Shadow (P201)
HDR	HDR (P208)/iHDR (P68)
	Multi exposure (P209)
	Digital Zoom (P156)
	Electronic shutter (P206)
120fps	High speed video (P181)
	Picture-taking during motion picture recording (Photo Priority) (P175)
	Overheat indicator (P321)

2

	RAW	Quality (P195)
	AFS AFF AFC MF	Focus Mode (P95, 107)
	BKT AFS	Focus Bracket (P146)
		Post Focus (P133)
		AF Mode (P97)
		Pull Focus (P178)
		Face Recognition (P225)
	AFL	AF Lock (P110)
		Burst (P119)
		4K Photo (P122)
		Self-timer (P143)
		Battery indication (P26)
		Power is being supplied (P25)
	BG	Battery Grip (P307)
		Image Stabiliser (P148)
		Jitter alert (P149)
	PRE	4K Pre-Burst/Pre-Burst Recording (P123)
		Focus (Lights green.) (P43)/ Recording state (Lights red.) (P169)
	LOW	Focus (Under low illumination) (P93)
	STAR	Focus (Starlight AF) (P93)
		Connected to Wi-Fi
		Connected to Bluetooth (P261)
	GPS	Location Logging (P273)
		Histogram (P221)



3

	Name ⁺² (P227)
	Number of days that have passed since the departure date ⁺³ (P229)
	Age ⁺² (P227)
	Location ⁺³ (P229)
	Current date and time/ Travel destination setting ⁺³ : (P229)
	Exposure metre (P223)
	Focal distance display (P157)
	Step zoom (P157)

















4

	AF area (P102)	
	Spot metering target (P201)	
	Centre marker display (P221)	
	Self-timer (P143)	
	Sound Rec level display (P179)	
	Sound Rec Level Limiter (OFF) (P179)	
	Silent Mode (P206)	
	External Microphone (P309)	
	AEL	AE Lock (P110)
		Metering Mode (P54, 201)
	P	Programme Shift (P71)
	F3.5	Aperture value (P43)
	BKT F3.5	Aperture Bracket (P146)
	60	Shutter speed (P43)
		Exposure compensation value (P111)
	BKT	Exposure Bracket (P145)
	±0	Brightness (P69, 92)
		Manual Exposure Assistance (P74)
	200	ISO sensitivity (P113)

5

BKT AWB ↓	White Balance Bracket (P147)
	White Balance Fine Adjustment (P117)
AWBc AWBw 	White Balance (P115)
	Colour (P69)
98	Number of recordable pictures (P33)
r20	Maximum number of pictures that can be taken continuously (P120)
R 8m30s	Available recording time*1 (P33)

6

Touch tab (P219)	
	 Touch zoom (P158)
	 Touch Shutter (P53)
	 Touch AF (P53)
	 Touch AE (P54)
	Peaking (P220)
	Fn4  Fn button (P60)
        MINI F SS ISO 	Colour (P69)
	Defocus control function (P69, 92)
	Brightness (P69, 92)
	Type of defocus ([Miniature Effect]) (P89)
	One point colour (P89)
	Position of the light source (P90)
	Image effect (filter) adjustment (P92, 199)
	Image effect ON/OFF (P199)
	Image effect (filter) (P199)
	Aperture value (P180)
	Shutter speed (P180)
ISO sensitivity (P180)	
Sound Rec level adjustment (P180)	

*1 h: hour, m: minute, s: second

*2 This is displayed for about 5 seconds when the camera is turned on if the [Profile Setup] setting is set.

*3 This is displayed for about 5 seconds when the camera is turned on, after setting the clock and after switching from Playback Mode to Recording Mode.

In playback

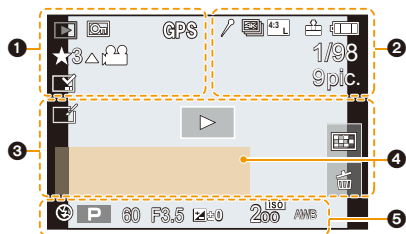

1

	Playback Mode (P241)
	Protected picture (P242)
GPS	Location Logging (P273)
	Rating (P242)
	Cable disconnect prohibit icon (P303)
	Motion picture playback (P185)
	Save pictures from the 4K burst file (P128)
	Create pictures from an image recorded with the Post Focus function (P135)
	Play panorama (P86)
	Continuous group picture playback (P190)
	Focus Bracket (P146, 189)
	Stamped with text indication (P250)
8m30s	Elapsed playback time*1 (P185)

2

	Icon indicating the presence of a marker (P129, 131)
	4K Photo (4K burst file) (P122)
	Post Focus (P133)
	Focus Stacking (P136)
	Aspect Ratio (P194)/ Picture size (P194)
	Recording format/Recording quality (P171)

	Snap Movie (P176)
120fps	High speed video (P181)
	Quality (P195)
	Battery indication (P26)
	Power is being supplied (P25)
	Battery Grip (P307)
1/98	Picture number/Total pictures
	Connected to Wi-Fi
9 pic.	Number of group pictures
8m30s	Motion picture recording time*1 (P185)

3

	Clear Retouch completed icon (P249)
	Currently retrieving information icon
	Playback (Motion Pictures) (P185)
	Group Display (P189)
	Silent Mode (P206)
	Number of days that have passed since the departure date (P229)
	Thumbnail display (P187)
	Delete (P191)

4

Name*2 (P225, 227)

Location*2 (P229)

Title*2 (P243)

Age (P225, 227)

5

Recording information

*1 h: hour, m: minute, s: second

*2 It is displayed in order of [Title], [Location], [Name] ((Baby1)/[Baby2], [Pet]),
[Name] ([Face Recog.]).

In playback

Detailed information display

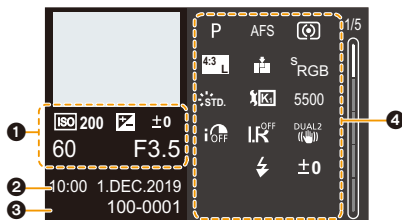

Histogram display

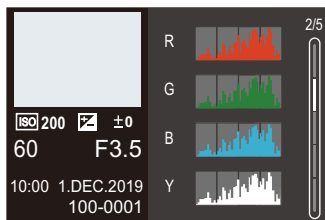
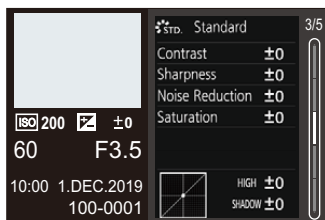
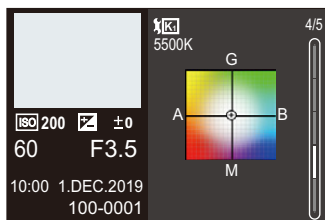

Photo style, Highlight shadow display



White balance display



Lens information display



1

Recording information (basic)

2

Recorded date and time/World Time (P228)

3

100-0001 Folder/File number (P301)

4

Recording information (advanced)

5500 White Balance Colour Temperature (P116)

iOFF Intelligent Dynamic Range Control (P202)

HDR ON HDR (P208)/iHDR (P68)

iR OFF Intelligent Resolution (P203)

Message Display

Meanings of main messages displayed on the camera screen, and response methods.

■ Card

[Memory Card Error]/[Format this card?]

- It is a format that cannot be used with the camera.
Either insert another card, or back up any necessary data before formatting. (P33)

[Memory Card Error]/[This memory card cannot be used]

- Use a card compatible with the camera. (P32)

[Insert SD card again]/[Try another card]

- Unable to access the card. Reinsert the card.
- Insert a different card.

[Read Error]/[Write Error]/[Please check the card]

- Failure to read or write data.
Turn off the camera, reinsert the card, and then turn it on again.
- The card may be broken.
- Insert a different card.

[Recording was cancelled due to the limitation of the writing speed of the card]

- Insufficient SD card write speed for motion picture, 4K photo, or Post-Focus recording.
Use an SD card of a supported Speed Class. (P32)
- If the recording stops even when you are using an SD card that meets the specified Speed Class rating, the data writing speed of the SD card is getting slow.
We recommend backing up data, and formatting (P33).
- Depending on the type of card, recording may stop part way.

■ Lens

[The lens is not attached properly. Do not push lens release button while lens is attached.]

- Remove the lens once, and then attach it again without pressing the lens release button. (P35)
Turn on the camera again, and if it is still displaying, contact the dealer.

[Lens attachment failed. Please make sure the lens is attached correctly.]

- Remove the lens from the camera body and gently wipe the contacts on the lens and the camera body using a dry cotton swab.
Attach the lens, turn on the camera again, and if it is still displaying, contact the dealer.

■ Battery

[This battery cannot be used]

- Use a genuine Panasonic battery.
If this message is displayed even when a genuine Panasonic battery is used, contact the dealer.
- If the terminal of the battery is dirty, remove the dirt and dust from them.

■ Wi-Fi

[Failed to connect wireless access point]/[Connection failed]/[No destination found]

- The wireless access point information set on the camera is wrong.
Check the authentication type and encryption key. (P287)
- Radio waves from other devices may block the connection to a wireless access point.
Check the status of other devices that are connected to the wireless access point as well as the status of other wireless devices.

[Connection failed. Please retry in a few minutes.]/[Network disconnected. Transfer stopped.]

- Radio waves from the wireless access point are getting weak.
Perform the connection closer to the wireless access point.
- Depending on the wireless access point, connection may be automatically disconnected after specific time has passed.
Reconnect the connection again.

[Connection failed]

- Change the access point to connect to in the smartphone Wi-Fi settings to the camera.

■ Others

[Some pictures cannot be deleted]/[This picture cannot be deleted]

- Images that do not comply with the DCF standard cannot be deleted.
Back up any necessary data before formatting the card. (P33)

[Cannot be set on this picture]

- Images that do not comply with the DCF standard cannot be edited.

[A folder cannot be created]

- The maximum number of folder numbers has been reached, so new folders cannot be created.
Back up any necessary data before formatting the card. (P33)
After formatting, execute [No.Reset] in the [Setup] menu to reset the folder number to 100.
(P236)

[Please turn camera off and then on again]/[System Error]

- Turn off and on the camera.
If the message is displayed even when doing this several times, contact the dealer.



Troubleshooting

First, try out the following procedures ([P321](#) to [P329](#)).

If the problem is not resolved, it may be improved by selecting [Reset] ([P236](#)) on the [Setup] menu.

Power, Battery

The charging lamp blinks.

- Charging is being performed in a place with extremely high or low temperature.
 - Reconnect the USB connection cable (supplied) and retry charging in a place where ambient temperature is 10 °C to 30 °C (50 °F to 86 °F) (temperature conditions also apply to the battery itself).
- Charging is not possible if the power supply capacity of the computer is low.

Camera does not work even if the camera is turned on. Camera switches off as soon as the camera is turned on.

- The battery is exhausted. Charge the battery. ([P21](#))

The camera turns off automatically.

- [Economy] is enabled. ([P231](#))

The battery becomes flat too quickly.

- When [4K Pre-Burst] or [Pre-Burst Recording] is set, the battery drains faster. Set these settings only when recording.
- When connected to Wi-Fi, the battery drains quickly. Turn the camera off frequently such as by using [Economy]. ([P231](#))

Recording

Recording stops before finishing.

Cannot record.

Cannot use some functions.

- In high ambient temperatures or if the camera is used for continuous recording, the temperature of the camera will rise. To protect the camera against a rise in temperature, after [, recording will be stopped, and the following functions will not be available for a time. Wait until the camera cools down.
 - [4K PHOTO]
 - Post Focus
 - Motion picture recording
 - Power supply via the USB connection cable

Cannot record images.**The shutter will not operate immediately when the shutter button is pressed.**

- If [Focus/Release Priority] is set to [FOCUS], then recording will not take place until focus is achieved. (P216)

The recorded image is whitish.

- Images may look whitish when the lens or image sensor gets dirty with fingerprints or similar. If the lens is dirty, turn the camera off, then wipe the lens surface with a soft, dry cloth. For information about how to clean the image sensor, refer to P331.

The recorded image is too bright or dark.

- Ensure AE Lock is not set where it is not appropriate. (P110)

Multiple images are recorded at once.

- When drive mode is set to [] (Burst), pressing and holding the shutter button will take burst pictures. (P118)
- When bracketing is set, then pressing the shutter button records multiple images while automatically changing the settings. (P144)

The subject is not focused properly.

- Confirm the following details:
 - Is the subject outside of the focus range?
 - Is [Shutter AF] set to [OFF]? (P214)
 - Is [Focus/Release Priority] set to [RELEASE]? (P216)
 - Is AF Lock (P110) set where it is not appropriate?
- If there are fingerprints or dirt on the lens, the focus may be set to the lens and, as a result, the subject may not be brought into focus.

The recorded image is blurred.**The stabiliser is not effective.**

- The shutter speed will become slower and the stabiliser function may not work properly when recording in dark places. In these cases, use a tripod and the self-timer when recording.

The recorded image looks rough.**Noise appears on the picture.**

- Try the following:
 - Reduce the ISO sensitivity. (P113)
 - Increase [Noise Reduction] of [Photo Style] to the positive direction, or adjust each item other than [Noise Reduction] to the negative direction. (P197)
 - Set [Long Shtr NR] to [ON]. (P204)

The subject appears distorted on the image.

- When a moving subject is recorded while using the following functions, the subject may appear distorted in the picture:
 - [ESHTR]
 - Motion picture recording
 - [4K PHOTO]
- This is a characteristic of the MOS sensor that is the image sensor of the camera, and is not a malfunction.

Striping or flicker may appear under lighting such as fluorescent lighting and LED lighting fixture.

- This is characteristic of MOS sensors which serve as the camera's pickup sensors.
This is not a malfunction.
- When using the electronic shutter (P206), lowering the shutter speed may reduce the effect of the horizontal stripes.
- If flicker or horizontal stripes are noticeable when recording motion picture, this can be mitigated by fixing the shutter speed.
Either set [Flkr Decrease] (P210), or record in Creative Video Mode (P180).



Stripes appear in high ISO sensitivity.

- Stripes may appear in high ISO sensitivity or depending on the lens you use.
Decrease the ISO sensitivity. (P113)

The brightness or colouring of the recorded image is different from the actual scene.

- When recording under fluorescent or LED lighting fixture, etc., increasing the shutter speed may introduce slight changes to brightness or colouring.
These are a result of the characteristics of the light source and do not indicate a malfunction.
- When recording subjects in extremely bright locations or recording under fluorescent lighting, LED lighting fixture, mercury lamp, sodium lighting, etc., the colouring or screen brightness may change or horizontal striping may appear on the screen.

Bright spot not in subject is recorded.

- Pixels may be missing from the image sensor.
Perform [Pixel Refresh]. (P237)

Motion pictures

Cannot record motion pictures.

- When using a large capacity card, you may not be able to record for a while after turning on the camera.

Motion picture recording stops in the middle.

- Recording motion picture using the SD card requires an SD card of a supported speed class. Use a compatible SD card. (P32)

Sometimes focus adjustment with AF mode is difficult while recording 4K motion pictures.

- This may occur when taking a picture by reducing the AF speed in order to adjust the focus at high precision. This is not a malfunction.

In motion pictures, abnormal clicking and buzzing sounds are recorded. The recorded audio is very quiet.

- Depending on the recording conditions or the lens used, the sound of aperture and focus actions may be recorded in motion pictures. You can set the focus operation during motion picture recording to [OFF] in [Continuous AF] (P172).
- Do not block the microphone hole during motion picture recording.

An operation sound is recorded in a motion picture.

- We recommend setting the Creative Video Mode and recording with touch operation if you are bothered about the operation sounds during recording. (P180)

Parts that are not in focus are indicated with Peaking.

- When you are using a [Photo Style] setting which uses an adjusted gamma curve, such as [V-Log L], the camera may incorrectly detect noise on images as contrast and indicate it with Peaking. We recommend checking focus with MF Assist before recording.



When motion pictures recorded with the Photo Style set to [V-Log L] are edited post-production, luminance and colour unevenness or noise appears.

- This camera records motion pictures in 4:2:0/8 bit, so luminance and colour unevenness or noise may appear in areas such as blue skies, people's skin, and white walls. We recommend performing trial recording in advance and editing and checking post-production images before proceeding to actual recording.

Playback**Cannot play back.
There are no recorded pictures.**

- Folders and images processed on a PC cannot be played on the camera. We recommend using the software "PHOTOfunSTUDIO" to write images from the PC to the card.
- Set [Playback Mode] to [Normal Play]. (P241)

Red part of the recorded image has changed colour to black.

- When Red-Eye Removal ([] or []) is performed, red parts may be corrected to black. We recommend recording images with the flash mode set to [] or [Red-Eye Removal] set to [OFF]. (P203)

Monitor/Viewfinder**The monitor/viewfinder turns off when the camera is turned on.**

- If no operations are performed during the set time period, [Auto LVF/Monitor Off] (P231) is activated, and the Monitor/Viewfinder turns off.
- When an object or your hand is positioned near the eye sensor, the Monitor display may switch to the Viewfinder display.

It may flicker for an instant or the brightness of the screen may change significantly for an instant.

- This occurs when the shutter button is pressed halfway, or when the subject brightness changes, making the lens aperture change.
This is not a malfunction.

Cannot switch between the monitor and viewfinder even when [LVF] is pressed.

- When the camera is connected to a PC or printer, it is not possible to switch to the viewfinder display.

Unevenly bright parts or irregular colours appear on the Monitor/Viewfinder.

- Monitor/viewfinder of this unit adopts OLED. Screen burn-in may occur on the monitor/viewfinder when a same image is displayed for a long period of time, but it does not affect the recorded images.
– Change the on-screen images frequently by using [Economy] (P231), [Eye Sensor] function (P42), or turning off the screen light (P49).

Monitor appears to be coloured when you see it from an angle.

- This is a characteristic of this unit's monitor, and this is not a malfunction.

The colouring of the viewfinder differs from the actual tone.

- This is characteristic of the viewfinder of the camera and not a malfunction. It does not affect the recorded images.

Flash

The flash does not fire.

- Open the flash if it is closed. (P159)
- The flash does not fire when [☹] (forced flash off) is selected. (P162, 163)

Wi-Fi Function

A Wi-Fi connection cannot be established.

Radio waves get disconnected.

Wireless access point is not displayed.

General tips for using a Wi-Fi connection

- Use within the communication range of the device to be connected.
- Usage near devices that utilise the 2.4 GHz frequency such as microwave ovens and cordless telephones may result in the radio wave being lost.
Use the camera at a sufficient distance from these devices.
- When the remaining battery level is low, it may not be possible to connect to or maintain communication with other devices.
(A message such as [Communication error] is displayed.)
- If you place the camera on a metal table or shelf, the radio waves may be adversely affected. In such cases, you may not be able to establish a connection.
Move the camera away from the metal surface.

Wireless access point

- Confirm that the connected wireless access point can be used.
- Confirm the radio wave conditions of the wireless access point.
 - Move the camera closer to the wireless access point.
 - Change the location and angle of the wireless access point.
- Depending on the wireless access point, the radio wave may not be displayed even though it is present.
 - Turn off and then on the wireless access point.
 - If the wireless channel of the wireless access point cannot be set automatically, manually set the channel supported by the camera.
 - If the wireless access point SSID is set not to broadcast, it may not be detected.
Enter the SSID, and then connect. (P287)

The camera is not displayed in the Wi-Fi setting screen of the smartphone.

- From the Wi-Fi setting menu on the smartphone, turn off and then on the Wi-Fi function.

When trying to connect to a PC by Wi-Fi, this does not recognise the user name and password, and connection is not possible.

- Depending on the version of the OS, there are two types of user account (local account/ Microsoft account).
Ensure you use the local account user name and password.

**The PC is not recognised when I use a Wi-Fi connection.
The camera cannot be connected to the PC using the Wi-Fi function.**

- At the time of purchase, this camera is set to use a workgroup name of "WORKGROUP". If you have changed the workgroup name of the PC, this will not be recognised. In the [Wi-Fi Setup] menu, [PC Connection], change the workgroup name of the PC to which to connect. (P291)
- Check that the login name and password are correctly typed.
- When the clock settings of the PC connected to the camera differs considerably from those of the camera, the camera cannot be connected to the PC depending on the OS.
 - Confirm that the [Clock Set]/[World Time] settings of the camera match the time, date, and time zone settings of the Windows or Mac.
 - If there are considerable differences, correct them.

**Transmission of the image fails midway.
Some images cannot be transmitted.**

- Is the size of the image too large?
 - Reduce the image size at [Size] (P279), and then send.
 - Transmit after dividing the motion picture with [Video Divide] (P253).
- It may take longer time to transmit when distance to the wireless access point is far. Transmit closer to the wireless access point.
- File format of the motion picture that can be sent differs depending on the destination. (P277)

I have forgotten the password for the Wi-Fi.

- In the [Setup] menu, [Reset], reset network settings. (P237)
However, all information set in [Wi-Fi Setup] and [Bluetooth] will also be reset.

TV, PC, Printer

No image on the TV. The TV screen is blurry or not coloured.

- Confirm the connection with the TV. (P294)
- Set the TV input to HDMI input.

VIERA Link is not working.

- Check that the [VIERA Link] of the camera is set to [ON]. (P234)
- Check the VIERA Link setting on the connected device.
- Turn off and on the camera.

Cannot communicate with the PC.

- Set the [USB Mode] of the camera to [PC(Storage)]. (P233)
- Turn the camera off and on.

The card is not recognised by the PC. (SDXC memory card is used.)

- Check if your PC supports SDXC memory cards.
- When connecting the camera to the PC, a message recommending that the card be formatted may be displayed. Do not format the card.
- If the [Access] displayed on the monitor does not disappear, turn off the camera and disconnect the USB connection cable, and then connect again.

Cannot print when the camera is connected to a printer.

- Pictures cannot be printed using a printer that does not support PictBridge.
- Set to [PictBridge(PTP)] in [USB Mode]. (P233)

The ends of the images are cut at printing.

- If the printer has trimming or borderless printing functions, cancel these settings before printing. (Refer to the operating instructions for your printer.)
- Depending on the photo studio, images recorded with their aspect ratio set to 16:9 can be printed at sizes in 16:9 aspect ratio. Ask the photo studio in advance.

Others

When I shake the camera, I hear a rattling sound from the camera.

- The sound is caused by the in-body stabiliser. This is not a malfunction.

When I shake the camera, I hear a rattling sound from the attached lens.

- Depending on the lens you attach, it may move inside and create a sound. This is not a malfunction.

The camera makes a noise when it is turned on.

- This is the noise of the dust reduction function working (P331); it is not a malfunction.

There is a sound from the lens unit.



- The lens movement and aperture operation emit sound when turning the camera on or off; this is not a malfunction.
- This is the sound of aperture operation when brightness changes; this is not a malfunction.

A red lamp sometimes lights when the shutter button is pressed halfway.

- In dark places, the AF Assist Lamp (P215) lights red to make it easier to focus on a subject.

An unreadable language was selected by mistake.

- Reselect the language from the menu using the following procedure:

MENU →  [Setup] →  → Select desired language (P234)

The camera becomes warm.

- During use, the camera may get warm, but this does not affect performance or quality.

The clock is wrong.

- When the camera is left for a long time, the clock may reset.
Reset the clock. (P39)

Cautions for Use

Optimal use of the camera

Keep this unit as far away as possible from electromagnetic equipment (such as microwave ovens, TVs, video games etc.).

- If you use this unit on top of or near a TV, the pictures and/or sound on this unit may be disrupted by electromagnetic wave radiation.
- Do not use this unit near cell phones because doing so may result in noise adversely affecting the pictures and/or sound.
- Recorded data may be damaged, or pictures may be distorted, by strong magnetic fields created by speakers or large motors.
- Electromagnetic wave radiation may adversely affect this unit, disturbing the pictures and/or sound.
- If this unit is adversely affected by electromagnetic equipment and stops functioning properly, turn this unit off and remove the battery or disconnect AC adaptor. Then reinsert the battery or reconnect AC adaptor and turn this unit on.

Do not use this unit near radio transmitters or high-voltage lines.

- If you record near radio transmitters or high-voltage lines, the recorded pictures and/or sound may be adversely affected.

Always use the supplied cords and cables.

If you use optional accessories, use the cords and the cables supplied with them.

Do not extend the cords or the cables.

Keep items away from the magnetic parts A that are easily influenced by magnetism.

- The effects of the magnets may cause items like bank cards, commuter cards, and clocks to cease functioning correctly.

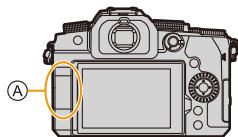

Do not spray the camera with insecticides or volatile chemicals.

- If the camera is sprayed with such chemicals, the body of the camera may be damaged and the surface finish may peel off.

Do not keep rubber or plastic products in contact with the camera for a long period of time.

Cleaning

Before cleaning the camera, remove the battery or the DC Coupler (optional) and the card (optional), and disconnect the power plug from the electrical outlet. Then wipe the camera with a dry, soft cloth.

- When the camera is soiled badly, it can be cleaned by wiping the dirt off with a wrung wet cloth, and then with a dry cloth.
- Do not use solvents such as benzene, thinner, alcohol, kitchen detergents, etc., to clean the camera, since it may deteriorate the external case or the coating may peel off.
- When using a chemical cloth, be sure to follow the accompanying instructions.

■ About dirt on the image sensor

If dirt gets inside the mount when changing lenses, depending on the recording conditions, it may adhere to the image sensor and appear on the recorded picture.

To prevent debris or dust adhering to internal parts of the body, avoid changing the lens in a dusty environment and always fit the body cap or a lens when storing the camera.

Remove any dirt on the body cap before attaching it.

Dust reduction function

The camera has a dust reduction function that will blow off the dirt and dust that have affixed to the front of the image sensor.

This function will function automatically when the camera is turned on, but if the dirt is particularly noticeable, from the [Setup] menu, perform [Sensor Cleaning].

Removing dirt on the image sensor

The image sensor is very precise and delicate, so be sure to observe the following when you do have to clean it yourself.

- Blow dust off the surface of the image sensor using a commercially available blower.
Do not blow the dust off with excessive power.
- Do not put the blower brush further inside than the lens mount.
- Do not let the blower brush touch the image sensor as the image sensor may get scratched.
- Do not use any objects except a blower brush to clean the image sensor.
- If you cannot remove the dirt or dust with the blower, consult the dealer or Panasonic.

■ Cleaning the Viewfinder

When the viewfinder becomes dirty, blow dirt off the surface of the viewfinder using a commercially available blower, then lightly wipe with a dry cloth.

- The eye cup is a built-in component, so be careful not to remove it.
- If you wipe the eye cup too hard and it is removed, consult the dealer or Panasonic.

Monitor/Viewfinder

- Do not push hard on the monitor.
This may cause irregular colouration or malfunction.
- If the camera is cold when you turn it on, the picture on the Monitor/Viewfinder will be slightly darker than usual at first. However, the picture will return to normal brightness when the internal temperature of the camera increases.

Extremely high precision technology is employed to produce the Monitor/Viewfinder screen. However there may be some dark or bright spots (red, blue or green) on the screen. This is not a malfunction. Though the Monitor/Viewfinder screen parts are produced with highly controlled precision technology, some pixels may be inactive or always lit. The spots will not be recorded on pictures on a card.

Lens

- Do not push hard on the lens surface.
- Do not aim the lens at the sun or strong light sources.
The concentrated light may cause fire or damage.
- Soiling on the lens surface (water, oil, fingerprints, etc.) may impact image quality.
Before and after use, lightly wipe the lens surface with a soft, dry cloth.
- When the camera is not being used, attach the lens cap and lens rear cap to prevent dust and dirt from adhering to or entering the camera.
- To protect the lens contact points (A), do not do the following.
These may cause a malfunction.
 - Touch the lens contact points.
 - Soil the lens contact points.
 - Place the lens with its mount surface facing down.
- To improve the dust and splash resistant performance of the interchangeable lens (H-FS12060/H-FSA14140), a lens mount rubber is used in the mount.
 - The lens mount rubber will leave scuff marks on the digital camera mount, but this does not impact performance.
 - To replace the lens mount rubber, contact Panasonic.

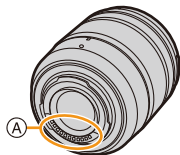

Battery

The battery is a rechargeable lithium ion battery.

It is highly sensitive to temperature and humidity, and the effect on performance increases as the temperature rises or drops.

Always remove the battery after use.

- Place the removed battery in a plastic bag, and store or keep away from metallic objects (clips, etc.).

If you drop the battery accidentally, check to see if the body of the battery and the contacts are deformed.

- Damage to the camera will result if a battery with deformed contacts is inserted into the camera.

Dispose of unusable battery.

- The battery has a limited life.
- Do not throw the battery into fire because it may cause an explosion.

Do not allow battery terminals to come into contact with metal objects (such as necklaces, hairpins, etc.).

- This can cause short-circuiting or heat generation and you may be badly burned if you touch a battery.

Charger, AC Adaptor

- The [CHARGE] lamp may blink under the influence of static electricity or electromagnetic wave, depending on the charging environment. This phenomenon has no effects on charging.
- If you use the battery charger near a radio, the radio reception may be disturbed. Keep the charger 1 m (3.3 feet) or more away from radio.
- During usage, the AC adaptor may emit an electrical hum; this is not a malfunction.
- After use, be sure to disconnect the power supply device from the electrical outlet. (A very small amount of current is consumed if it is left connected.)
- Keep the contacts of the charger and battery clean. Wipe them with a dry cloth if they get dirty.

Card

Do not leave the card in areas with high temperatures, direct sunlight, or areas prone to electromagnetic waves and static.

Do not bend or drop the card.

Do not subject the card to strong vibration.

- Otherwise, the card and recorded data may be damaged.
- Put the card in the card case or the storage bag after use and when storing or carrying the card.
- Do not allow dirt, water or other foreign objects to get into the contacts on the card. Additionally, do not touch the contacts with your hands.

Points to remember when disposing of/transferring the memory card

Format or delete using the camera or a PC will only modify the file management information, so it will not delete the data in the card completely.

We recommend physically destroying the card or using commercially available PC data deletion software to delete the card data completely when disposing of/transferring the card.

You are responsible for handling of data on cards.

About the personal information

Personal information is stored within the camera and in recorded images.

We recommend that you enhance security by setting a Wi-Fi password and Wi-Fi function lock to protect personal information. (P291 , 292)

- **Be sure to pay special attention to the privacy, likeness rights, etc. of a subject and take your own responsibility when you use the [Silent Mode], or use functions such as writing the location information and changing the shutter noise, etc.**

Disclaimer

- Information including personal information may be altered or vanish due to erroneous operation, effect of static electricity, accident, malfunction, repair, or other handlings. Please note in advance that Panasonic is not liable in any way for any direct or indirect damage from the alteration or vanishing of information or personal information.

When requesting a repair or transferring/disposing of the camera

- After making a copy of personal information, be sure to delete information, including personal information, such as wireless LAN connection settings that you have registered or saved within the camera with [Reset Network Settings]. (P237)
- Reset the settings to protect the personal information. (P236)
- Remove the card from the camera.
- Settings may return to factory default when camera is repaired.
- Please contact the dealer where you purchased the camera or Panasonic if above operations are not possible due to malfunction.

When transferring/disposing of the card, refer to “Points to remember when disposing of/transferring the memory card” on page 334.

When uploading images to a web service

- Images may contain information that can be used to identify the user, such as recording dates and times, and location information.
Confirm details carefully before uploading images to a web service.

When not using the camera for a long period of time

- Ensure you remove the battery and card from the camera.
When the battery is left inserted in the camera, a small amount of current will always flow even if the camera is turned off.
If the battery is left in the camera, it may over-discharge, and be rendered unusable even after charging.
- Store the battery in a cool and dry place with a relatively stable temperature.
(Recommended temperature: 15 °C to 25 °C (59 °F to 77 °F); recommended humidity: 40%RH to 60%RH)
- If storing for a long period of time, it is recommended that the battery be charged once per year, fully drained in the camera, then removed from the camera and then stored again.
- We recommend storing the camera with a desiccant (silica gel) when you keep it in a closet or a cabinet.
- Check all the parts before recording when you have not used the camera for a long period of time.

Image Data

- Recorded data may be damaged or lost if the camera breaks down due to inappropriate handling.
Panasonic will not be liable for any damage caused due to loss of recorded data.

Tripods or unipods

- Make sure the tripod is stable when the camera is attached to it.
- When using a tripod or unipod, removal of the battery may not be possible.
- Make sure that the screw on the tripod or unipod is not at an angle when attaching or removing the tripod or unipod.
Using excessive force may damage the camera tripod mount.
Also, care is required because tightening the screw excessively may damage the camera, or cause the rating label to come off.
- When using this unit with a large-diameter lens, the lens may come into contact with the pedestal depending on the tripod/unipod. Tightening the screw with the lens and pedestal in contact with each other may damage this unit or the lens. Therefore it is recommended to attach the tripod adaptor (DMW-TA1: optional) before mounting on the tripod/unipod.
- Please also refer to the operating instructions for the tripod or unipod.

Shoulder Strap

- If you attach a heavy interchangeable lens (more than about 1 kg/35.3 oz) to the camera body, do not carry the camera by the shoulder strap.
Hold the camera and the lens when carrying them.

Wi-Fi function

■ Use the camera as a wireless LAN device

When using equipment or computer systems that require more reliable security than wireless LAN devices, ensure that the appropriate measures are taken for safety designs and defects for the systems used. Panasonic will not take any responsibility for any damage that arises when using the camera for any purpose other than as a wireless LAN device.

■ Use of the Wi-Fi function of this camera is presumed to be in countries where this camera is sold

There is the risk that the camera violates the radio wave regulations if used in countries other than those where this camera is sold, and Panasonic takes no responsibility for any violations.

■ There is the risk that data sent and received via radio waves may be intercepted

Please note that there is the risk that data sent and received via radio waves may be intercepted by a third party.

We strongly recommend that you set an encryption to maintain information security.

■ Do not use the camera in areas with magnetic fields, static electricity or interference

- Do not use the camera in areas with magnetic fields, static electricity or interference, such as near microwave ovens. These may cause the interruption of the radio waves.
- Using the camera near devices such as microwave ovens or cordless telephones that use the 2.4 GHz radio wave band may cause a decrease in performance in both devices.

■ Do not connect to the wireless network you are not authorised to use

When the camera utilises its Wi-Fi function, wireless networks will be searched automatically. When this happens, wireless networks that you are not authorised to use (SSID*) may be displayed, however do not attempt to connect to the network as it may be considered as unauthorised access.

- * SSID refers to the name that is used to identify a network over a wireless LAN connection. If the SSID matches for both devices, transmission is possible.

- Micro Four Thirds™ and Micro Four Thirds Logo marks are trademarks or registered trademarks of OM Digital Solutions Corporation, in Japan, the United States, the European Union and other countries.
- Four Thirds™ and Four Thirds Logo marks are trademarks or registered trademarks of OM Digital Solutions Corporation, in Japan, the United States, the European Union and other countries.
- SDXC Logo is a trademark of SD-3C, LLC.
- The terms HDMI and HDMI High-Definition Multimedia Interface, and the HDMI Logo are trademarks or registered trademarks of HDMI Licensing Administrator, Inc. in the United States and other countries.
- "AVCHD", "AVCHD Progressive" and the "AVCHD Progressive" logo are trademarks of Panasonic Holdings Corporation and Sony Corporation.
- Dolby, Dolby Audio, and the double-D symbol are trademarks of Dolby Laboratories.
- HDAVI Control™ is a trademark of Panasonic Holdings Corporation.
- Adobe is a trademark or registered trademark of Adobe Systems Incorporated in the United States and/or other countries.
- Pentium is a trademark of Intel Corporation in the U.S. and/or other countries.
- Windows is a registered trademark or trademark of Microsoft Corporation in the United States and/or other countries.
- iMovie, Mac, OS X and macOS are trademarks of Apple Inc., registered in the U.S. and other countries.
- iPad, iPhone, iPod, and iPod touch are trademarks of Apple Inc., registered in the U.S. and other countries.
- App Store is a service mark of Apple Inc.
- Google, Android and Google Play are trademarks of Google LLC.



- The Bluetooth® word mark and logos are registered trademarks owned by Bluetooth SIG, Inc. and any use of such marks by Panasonic Holdings Corporation is under license. Other trademarks and trade names are those of their respective owners.
- The Wi-Fi CERTIFIED™ Logo is a registered trademark of Wi-Fi Alliance®.
- The Wi-Fi Protected Setup™ Logo is a trademark of Wi-Fi Alliance®.
- “Wi-Fi®” is a registered trademarks of Wi-Fi Alliance®.
- “Wi-Fi Protected Setup™”, “WPA™”, and “WPA2™” are trademarks of Wi-Fi Alliance®.
- DLNA, the DLNA Logo and DLNA CERTIFIED are trademarks, service marks, or certification marks of the Digital Living Network Alliance.
- This product uses “DynaFont” from DynaComware Corporation. DynaFont is a registered trademark of DynaComware Taiwan Inc.
- QR Code is a registered trademark of DENSO WAVE INCORPORATED.
- Other names of systems and products mentioned in these instructions are usually the registered trademarks or trademarks of the manufacturers who developed the system or product concerned.



This product is licensed under the AVC Patent Portfolio License for the personal use of a consumer or other uses in which it does not receive remuneration to (i) encode video in compliance with the AVC Standard (“AVC Video”) and/or (ii) decode AVC Video that was encoded by a consumer engaged in a personal activity and/or was obtained from a video provider licensed to provide AVC Video. No license is granted or shall be implied for any other use. Additional information may be obtained from MPEG LA, L.L.C.

See <http://www.mpegla.com>