

Panasonic®

REFRIGERATOR-FREEZER

Operating instructions

Model No : NR-BC641VSAE

Thank you very much for purchasing Panasonic Product.

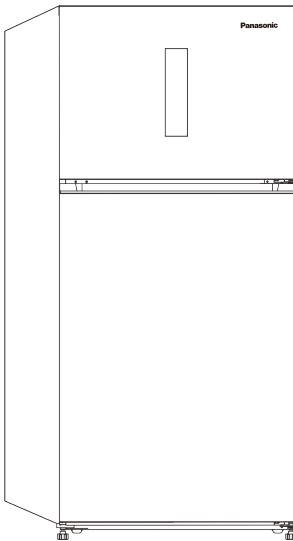

*Picture is only for illustration

Contents

1. SAFETY	2
2. Product features	4
3. Specifications	4
4. Preparations for use	5
5. Functions	6
6. Instructions for food storage	9
7. Tips for special needs	10
8. Maintenance and cleaning	10
9. Simple fault analysis and elimination	11
10. Certifications	12
11. Safe recovery instructions	12



Manufacturer&Importer: Panasonic Marketing Middle East & Africa FZE
Address: P.O.Box 17985, Jebel Ali Free Zone, Dubai, United Arab Emirates

- Please read these instructions carefully and follow safety precautions before using this product.
- Please keep product purchase documents like invoice copy with this operating instructions manual for warranty claim purpose.

Contents

1. SAFETY.....	2
2. Product features	4
3. Specifications.....	4
4. Preparations for use	5
5. Functions.....	6
6. Instructions for food storage	9
7. Tips for special needs	10
8. Maintenance and cleaning	10
9. Simple fault analysis and elimination.....	11
10. Certifications.....	12
11. Safe recovery instructions.....	12

SAFETY



WARNING!

It is hazardous for anyone other than authorized service personnel to carry out servicing or repairs which involves the removal of covers. To avoid the risk of an electric shock do not attempt to repair this appliance yourself.

WARNING!

Risk of fire / flammable materials.



Safety tips

Do not use electrical appliances such as a hair dryer or heater to defrost your Fridge/Freezer.

Containers with flammable gases or liquids can leak at low temperatures.

Do not store any containers with flammable materials, such as spray cans, fire extinguisher refill cartridges etc. in the Fridge/Freezer.

Do not place carbonated or fizzy drinks in the Freezer compartment. Ice lollies can cause "Frost/Freeze burns". If consumed straight from the Fridge/Freezer.

Do not remove items from the Fridge/Freezer compartment if your hands are damp/wet, as this could cause skin abrasions or "Frost/Freezer burns". Bottles and cans must not be placed in the Freezer compartment as they can burst when the contents freeze.

Manufacturer's recommended storage times should be adhered to. Refer to relevant instructions.

Do not allow children to tamper with the controls or play with the Fridge/Freezer. The Fridge/Freezer is heavy. Care should be taken when moving it. It is dangerous to alter the specification or attempt to modify this product in any way.

Do not store inflammable gases or liquids inside your Fridge/Freezer.

If the power cable is damaged, it must be replaced by the manufacturer, its service agent or similarly qualified persons in order to avoid a hazard.

This appliance is not intended for use by persons (including children) with reduced physical, sensory or mental capabilities, or lack of experience and knowledge, unless they have been given supervision or instruction concerning use of the appliance by a person responsible for their safety.

This refrigerating appliance is not intended to be used as a built-in appliance.

This appliance is intended to be used in household and similar applications such as

- staff kitchen areas in shops, offices and other working environments;
- farm houses and by clients in hotels, motels and other residential type environments;
- bed and breakfast type environments;
- catering and similar non-retail applications.

Keep ventilation openings, in the appliance enclosure or in the built-in structure, clear of obstruction.

Do not use mechanical devices or other means to accelerate the defrosting process, other than those recommended by the manufacturer.

Do not damage the refrigerant circuit.

Do not use electrical appliances inside the food storage compartments of the appliance, unless they are of type

recommended by the manufacturer.

Do not store explosive substances such as aerosol cans with a flammable propellant in this appliance.

This appliance is not intended for use by persons (including children) with reduced physical, sensory or mental capabilities, or lack of experience and knowledge, unless they have been given supervision or instruction concerning use of the appliance by a person responsible for their safety. Children should be supervised to ensure that they do not play with the appliance.

– **WARNING:** Keep ventilation openings, in the appliance enclosure or in the built-in structure, clear of obstruction.

– **WARNING:** Do not use mechanical devices or other means to accelerate the defrosting process, other than those recommended by the manufacturer.

– **WARNING:** Do not damage the refrigerant circuit.

– **WARNING:** Do not use electrical appliances inside the food storage compartments of the appliance, unless they are of the type recommended by the manufacturer.

– **WARNING:** Refrigerating appliances – in particular a refrigerator-freezer Type I – might not operate consistently (possibility of defrosting of contents or temperature becoming too warm in the frozen food compartment) when sited for an extended period of time below the cold end of the range of temperatures for which the refrigerating appliance is designed;

– **WARNING:** The necessity that, for doors or lids fitted with locks and keys, the keys be kept out of the reach of children and not in the vicinity of the refrigerating appliance, in order to prevent children from being locked inside.

– **WARNING:** The refrigerant used in your appliance and insulation materials requires special disposal procedures.

– **WARNING:** When positioning the appliance, ensure the supply cord is not trapped or damaged.

– **WARNING:** Do not locate multiple portable socket-outlets or portable power supplies at the rear of the appliance

Children aged from 3 to 8 years are allowed to load and unload refrigerating appliances.

To avoid contamination of food, please respect the following instructions:

– Opening the door for long periods can cause a significant increase of the temperature in the compartments of the appliance.

– Clean regularly surfaces that can come in contact with food and accessible drainage systems.

– Clean water tanks if they have not been used for 48 h; flush the water system connected to a water supply if water has not been drawn for 5 days.

– Store raw meat and fish in suitable containers in the refrigerator, so that it is not in contact with or drip onto other food.

– Two-star frozen-food compartments are suitable for storing pre-frozen food, storing or making ice-cream and making ice cubes.

– One-, two- and three-star compartments are not suitable for the freezing of fresh food.

– If the refrigerating appliance is left empty for long periods, switch off, defrost, clean, dry, and leave the door open to prevent mold developing within the appliance.

Electrical Connection

▲WARNING▲

This appliance should be properly grounded for your safety. The power cord of this appliance is equipped with a three-prong plug which mates with the standard three prong wall outlets to minimize the possibility of electrical shock.

Do not, under any circumstances, cut or remove the third ground prong from the power cord supplied.

This refrigerator appliance requires a standard 220-240VAC 50/60Hz electrical outlet with grounding.

This refrigerator appliance is not designed to be used with an inverter.

The cord should be secured behind the appliance and not left exposed or dangling to prevent accidental injury.

Never unplug the refrigerator by pulling the power cord. Always grip the plug firmly and pull straight out from the receptacle.

Do not use an extension cord with this appliance. If the power cord is too short, have a qualified electrician or service technician install an outlet near the appliance. Use of an extension cord can negatively affect the performance of the unit. Improper use of the grounded plug can result in the risk of electrical shock. If the power cord is damaged, have it replaced by an authorized service center.

Climate Range

The information about the climate range of the appliance is provided on the rating plate. It indicates at which ambient temperature (that is, room temperature, in which the appliance is working) the operation of the appliance is optimal (proper).

Climate range	Permissible ambient temperature
---------------	---------------------------------

SN	from +10°C to +32°C
N	from +16°C to +32°C
ST	from +16°C to +38°C
T	from +16°C to +43°C

Note: Given the limit values of the ambient temperature range for the climate classes for which the refrigerating appliance is designed and the fact that the internal temperatures could be affected by such factors as location of the refrigerating appliance, ambient temperature and the frequency of door opening, the setting of any temperature control device might have to be varied to allow for these factors, if appropriate.

Locks

If your Refrigerator is fitted with a lock, keep the key out of reach and not in the vicinity of the appliance to prevent children being entrapped. When disposing of an old Refrigerator, break off any old locks or latches as a safeguard.

Freon-free

The freon-free refrigerant (R600a) and the foaming insulation material (cyclopentane) that is environmentally friendly are used for the refrigerator, causing no damage to the ozone layer and having a very small impact on the global warming. R600a is flammable, and sealed in a refrigeration system, without leakage during normal use. But, in case of refrigerant leakage due to the refrigerant circuit being damaged, be sure to keep the appliance away from open flames and open the windows for ventilation as quickly as possible.

Product Features

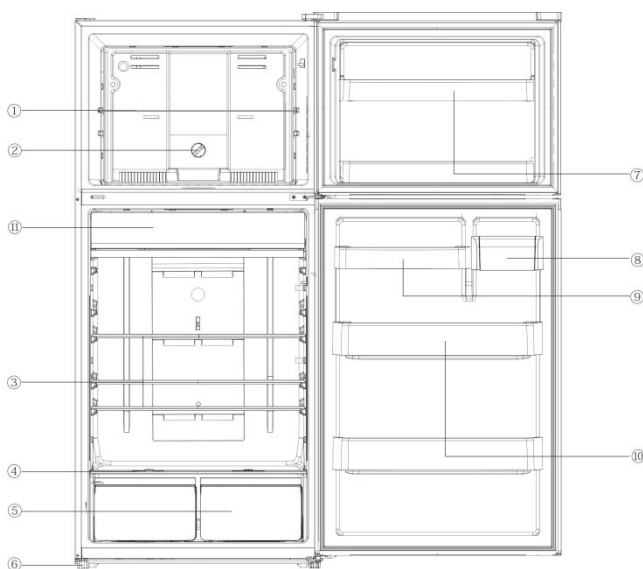

No	Description
1	Freezer Shelf
2	Air control knob
3	Fridge Glass Shelf
4	Crisper Cover
5	Salad Crisper
6	Adjustable foot
7	Bottle Rack
8	Butter box
9	Little Bottle Rack
10	Bottom Bottle Rack
11	Fresh room

Note: Due to technological innovation, the product descriptions in this manual may not be completely consistent with your refrigerator. Details are in accordance with the real product.

Specifications :

Description	Refrigerator-Freezer
Model	NR-BC641VSAE

Energy efficiency class	4-star
Annual energy consumption (AEC)	400 kWh/year
Temperature rise time	12h
Freezing capacity	6kg/24h
Climate class	SN/N/ST/T
Rated voltage	220-240V~
Rated frequency	50/60Hz
Rated current	1.17AMPERES
Defrosting power	200W
Refrigerant charge	R600a/52g
Rated storage volume	515L/18.18cu.ft
Volume of fresh food	386L/13.63cu.ft
Volume of freezer	129L/4.55cu.ft
Refrigerator compartment(frost-free)	Y
Freezer compartment(frost-free)	Y
Lamp Power	MAX.4W
Foaming Agent	CYCLOPENTANE
Classification of protection against electric shock	Class I
Net Weight	80kg

Diagram of Circuit Principles

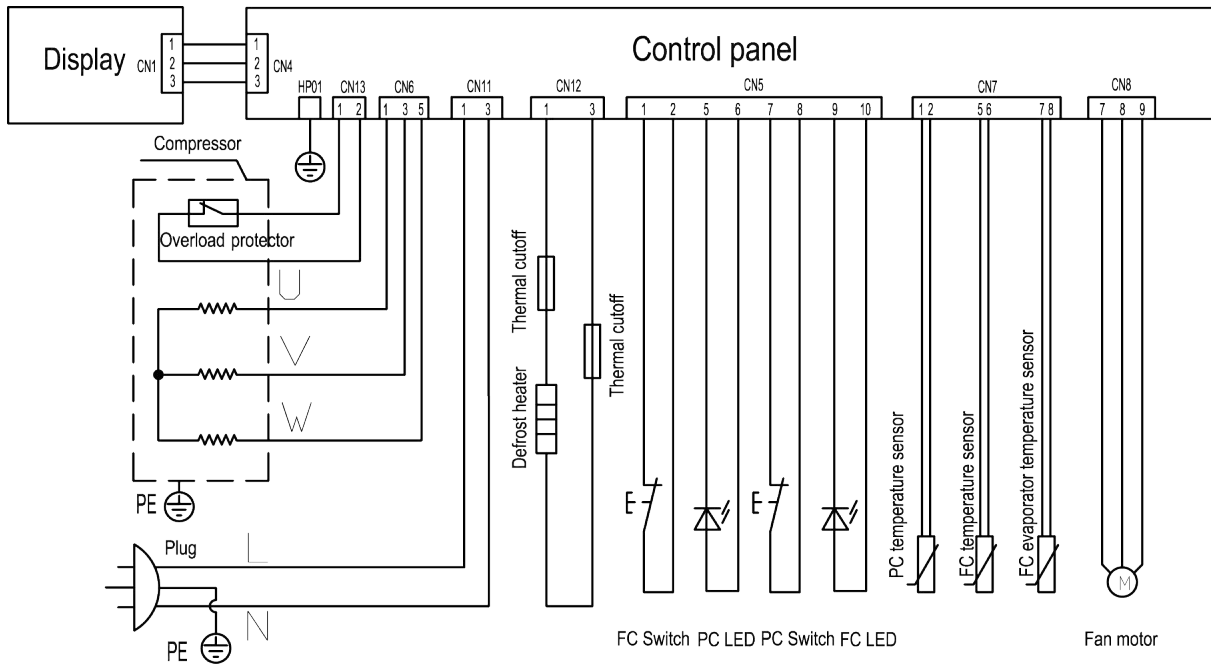

Preparations for use

Installation location

1. Ventilation condition

The position you select for the refrigerator installation should be well-ventilated and has less hot air. Do not locate the refrigerator near a heat source such as cooker, boiler, and avoid it from direct sunlight, thus guaranteeing the refrigeration effect while saving energy consumption. Do not locate the refrigerator in the damp place, so as to prevent the refrigerator from rusting and leaking electricity. The result of the refrigerant charge amount of the refrigerator being divided by the total space of the room in which the refrigerator is installed shall be less than $8g / m^3$.

Note: The amount of refrigerant charged for the refrigerator can be found on the nameplate.

2. Heat dissipation space

When working, the refrigerator gives off heat to surroundings. Therefore, at least **30mm** of free space should be spared at the top side, more than 100mm on both sides, and above 50mm at the back side of the refrigerator.

Dimensions in mm

W	D	H	A	B	C(°)	E	F
750	785	1680	1280	1490	130 ± 5	50	100

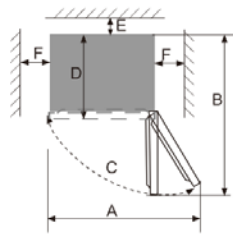
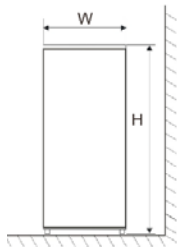

Fig. 1

Fig. 2

Note: Figure 1, Figure 2 only illustrate the space demand of the product.

Level ground

Place the refrigerator on the solid and flat ground (floor) to keep it stable, or else, it will give rise to vibration and noise. When the refrigerator is placed on such flooring materials as carpet, straw mat, polyvinyl chloride, the solid backing plates should be applied underneath the refrigerator, so as to prevent color change due to heat dissipation.



Unobstructed ventilation shall be maintained around the appliance or in an embedded structure.

Preparations for use

1. Standing time

After the refrigerator is properly installed and well cleaned, do not switch it on immediately. Make sure to energize the refrigerator after more than 1 hour of standing, so as to ensure its normal operation.

2. Cleaning

Confirm the accessory parts inside the refrigerator and wipe the inside with a soft cloth.

3. Power-on

Insert the plug into the solid socket to start the compressor. After 1 hour, open the freezer door, if the temperature inside the freezer compartment drops obviously, it indicates the refrigeration system is working normally.

4. Storage of food

After the refrigerator runs for a period of time, the internal temperature of the refrigerator will be automatically controlled according to the user's temperature setting. After the refrigerator is fully cooled, put in foods, which usually need 2~3 hours to be fully cooled. In summer, when the temperature is high, it takes more than 4 hours for the foods to be fully cooled (Try to open the refrigerator door as less as possible before the internal temperature cools down).



If the refrigerator is installed in the moisture place, make sure to check whether the ground wire and leakage circuit breaker are normal. If vibration noises are produced due to the refrigerator contacting the wall or if the wall gets blackened by air convection around the compressor, move the refrigerator away from the wall. Setting up the refrigerator may cause jamming noise or image chaos to the mobile phone, fixed-line telephone, radio receiver, television set surrounding it, so try to keep the refrigerator as far away as possible in such case.

Functions

1.1 temperature setting

Press the Temp button to adjust the temperature. After the temperature is adjusted to the expected gear, the setting will take effect if no more key operation is performed within 5 seconds, and the corresponding gear will be operated immediately. Temperature gear setting cycle sequence: "5-4-2-8-6-5"

1.2 fast cooling

1) As the fridge chamber cools quickly, so does the temperature of the freezer to ensure that the food is well preserved with nutrition and good taste. Quick cooling function can be maintained for up to 30 hours. After that, it will automatically exit and the temperature gear will return to the setting before the quick-cooling feature was enabled.

2) how to enter the fast cooling function

Press the Mode button till the fast-cooling icon blinks. Within 5 seconds, if no more key operation is performed, the fast-cooling icon remains steady on to complete the setting.

3) Exit the fast-cooling function

After 30 hours of operation, the fast-cooling function will automatically exit.

Under the fast-cooling function, press the Mode button until the Intelligence icon flashes. Within 5 seconds, if no more key operation is performed, it will enter the intelligence function and exit the fast-cooling function.

Under the fast-cooling function, press the Temp key to adjust the temperature to the expected gear. Within 5 seconds, if no more key operation is performed, it will enter the corresponding temperature gear control operation and exit the fast-cooling function;

1.3 Intelligence

1)The fridge chamber enters the intelligent mode, and the products will adjust the temperature in the chamber automatically according to the real-time monitoring of the temperature in the fridge and the ambient temperature, so as to ensure the fresh and long-term storage of the ingredients in the fridge.

2) How to enter the intelligence function

Press the Mode button until the intelligence icon blinks. Within 5 seconds, if no more button operation is performed, the intelligence icon remains steady on to complete the setting.

3) Exit the intelligence function

Under the intelligence function, press the Mode button till the icon of fast cooling flashes. Within 5 seconds, if no more key operation is performed, it will enter the fast-cooling function and exit the intelligence function;

Under the intelligence function, press the Temp key to adjust the temperature to the expected gear. Within 5 seconds, if no more key operation is performed, it will enter the corresponding temperature gear control operation, and exit the intelligent function.

1.4 Child Lock

When the Child Lock function is enabled, the temperature and function are subjected to no change to prevent maloperation.

In case of no key operation within 3 minutes, the Child Lock function will be enabled automatically.

Exiting the Child Lock function manually

Press and hold down the TEMP (3s to Unlock) for 3s, then the Child Lock function can be disabled.

1.5 Door open alarm

If the refrigerator door is open for more than 3 minutes, buzzer alarms will be continuously issued, which can be stopped when any key is pressed, but will be restored after 3 minutes if the door keeps open. The alarms will not be lifted until the refrigerator door is closed.

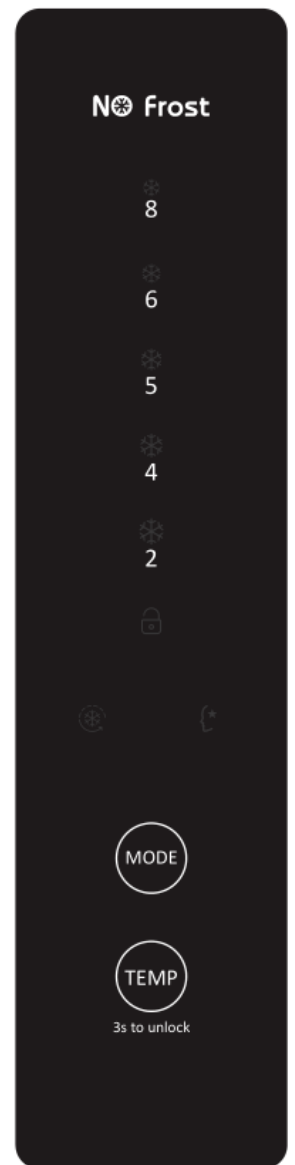

1.6 Power cut memory

In the case of power failure, the refrigerator will maintain the running state that is set before the power outage when the power supply is restored.

1.7 Power-on delay

In order to protect the refrigerator compressor from being damaged in the case of short-time power failure (i.e., less than 5 minutes), the compressor will not be started immediately after it is powered on.

1.8 Fault alarm

When the indicator light of temperature mode 2, temperature mode 5 or temperature mode 8 keeps flashing, the refrigerator is faulty, please contact the after-sales staff for home service as soon as possible.

In case of communication fault, the indicator light of mode "4" keeps flashing for alarm.

In case of freezer sensor fault, the indicator light of mode "6" keeps flashing for alarm;

In case of the occurrence of two or more faults at the same, the corresponding indicator lights keep flashing simultaneously for alarm.

Freezer temperature adjustment



1. When the temperature mode keeps unchanged, adjust the air regulating rod from left to right, the fridge temperature gets increased while the freezer temperature decreased.
2. When the temperature mode keeps unchanged, adjust the air regulating rod from right to left, the fridge temperature gets decreased while the freezer temperature increased.
3. It is recommended to adjust the air regulating rod in the middle position. When the user needs a lower freezer temperature, adjust the air regulating rod to the right properly, then the freezer temperature decreases while the fridge temperature rises. When the temperature meets the requirement, adjust the air regulating rod back to the middle position again in a timely manner.

The fridge control panel and the air control knob should be used in combination.

When the freezer air control knob is in the middle position, the temperature ranges of the corresponding fridge temperature modes are as below:

Mode	2	4	5	6	8
Temperature (°C)	0-3	2-5	3-6	4-7	6-9

Temperature settings are recommended as following:

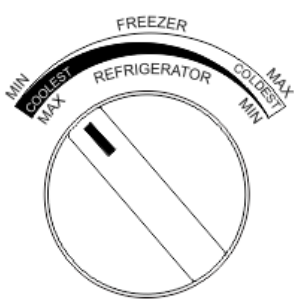
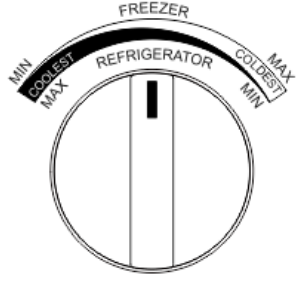
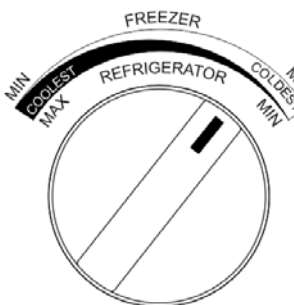
	Use environment	Higher than 35°C	16°C-35°C	Lower than 16°C)
Temperature adjustment	Recommended mode setting on the display panel			
	Recommended air control knob position			
	Notes	1) It is recommended to set at the middle mode. 2) The temperature modes can be adjusted as recommended in the left table in case of change to the ambient temperature around the refrigerator.		

Instructions for food storage

Precautions for use

- The appliance might not operate consistently (there is possibility of defrosting or temperature becoming too warm in the frozen food compartment) when sited for an extended period of time below the cold limit of the temperature range for which the refrigerating appliance is designed
- The information of climate type of the appliance is provided on the rating plate.
- The internal temperature could be affected by such factors as the location of refrigerating appliance, ambient temperature, and frequency of door open, etc., and if appropriate, a warning that setting of any temperature control device might have to be varied to allow for these factors should be made.
- Effervescent drinks should not be stored in the freezer compartment or the low-temperature compartment, and some products such as water ices should not be consumed too cold.

Food storage location

Due to the cold air circulation in the refrigerator, the temperature of each area in the refrigerator is different, so different kinds of food should be placed in different areas.

The fresh food compartment is suitable for the storage of such foods as need not to be frozen, the cooked food, beer, eggs, some condiments that need cold preservation, milk, fruit juice, etc. The crisper box is suitable for the preservation of vegetables, fruits, etc.

The freezer compartment is suitable for the storage of ice cream, frozen food and the foods to be preserved for a long time.

Use of the fresh food compartment

Fridge shelf: When removing the shelf, lift it up first, and then pull it out; and when installing the shelf, place it into position before putting it down. (For the two-section shelf, push the first section to the rear end, and then pull the second section out). Keep the shelf rear flange upward, to prevent foods from contact the liner wall. When taking out or putting in the shelf, hold it firmly, and handle with care to avoid damage.

Crisper box: Pull out the crisper box for access to food. After using or cleaning the cover plate of the crisper box, be sure to put it back onto the crisper, so that the internal temperature of the crisper box will not be affected.

Use of the humidity regulating rod of the crisper box

The humidity regulating rod is used to preserve moisture inside the crisper box, so as to keep fresh the vegetables and fruits stored inside.

When the humidity regulating rod is adjusted to the right side, with more holes exposed, the internal moisture of the crisper box can be maintained at the low level.

When the humidity regulating rod is adjusted to the left side, with less holes exposed, the internal humidity of the crisper box can be maintained at the high level.

Cautions for food storage

You'd better clean the foods and wipe them dry before storing them inside the refrigerator. Before foods are put in the refrigerator, it is advisable to seal them up, so as to prevent water evaporation to keep fresh fruits and vegetables on one hand, and prevent taint of odor on the other hand.

Do not put too many or too weight foods inside the refrigerator. Keep enough space between foods; if too close, the cold air flow will be blocked, thus affecting the refrigeration effect. Do not store excessive or overweight foods, to avoid the shelf from being crushed. When storing the foods, keep a distance away from the inner wall; and do not place the water-rich foods too close to the fridge rear wall, lest they get frozen on the inner wall.

Categorized storage of foods: Foods should be stored by category, with the foods you eat every day placed in front of the shelf, so that the door open duration can be shortened and food spoilage due to expiration can be avoid.

Energy-saving tips: Allow the hot food cool down to the room temperature before putting it in the refrigerator. Put the frozen food in the fresh food compartment to thaw, using the low temperature of the frozen food to cool the fresh food, thus saving energy.

Storage of fruits and vegetables

In the case of refrigerating appliances with chill compartment, a statement to the effect that some types of fresh vegetables and fruits are sensitive to cold and therefore are not suitable for storage in this kind of compartment should be made.

Use of the frozen food storage compartment

The freezer temperature is controlled below -18°C , and it is advisable to store the food for long-term preservation in the freezer compartment, but the storage duration indicated on the food packaging should be adhered to.

The freezer drawers are used to store food that needs to be frozen. Fish and meat of large block size should be cut into small pieces and packed into fresh-keeping bags before they are evenly distributed inside the freezer drawers.

- ★ Allow the hot foods to cool down to the room temperature before putting them in the freezer compartment.
- ★ Do not put a glass container with liquid or the canned liquid that is sealed in the freezer compartment, so as to avoid burst due to volume expansion after the liquid gets frozen up.
- ★ Divide the food into appropriately small portions
- ★ You'd better pack the food up before freezing it, and the packing bag used should be dry, in case the packing bags are frozen together. Foods should be packed or covered by such suitable materials as are firm, tasteless, impervious to air and water, non-toxic and pollution-free, to avoid cross-contamination and transfer of odor.

Tips for special needs

Moving the refrigerator/freezer

•Location

Do not place your refrigerator/freezer near a heat source, e.g., cooker, boiler, or radiator. Avoid it from direct sunlight in out-buildings or sun lounges.

•Leveling

Make sure to level your refrigerator/freezer using the front leveling feet. If not level, the refrigerator/freezer door gasket sealing performance will be affected, or even it may lead to the operating failure of your refrigerator/freezer.

After locating the refrigerator/freezer in position, wait for 4 hours before using it, so as to allow the refrigerant to settle.

•Installation

Do not cover or block the vents or grilles of your appliance.

When you are out for a long time

- If the appliance will not be used for several months, turn it off first, and then unplug the plug from the wall outlet.
- Take out all foods.
- Clean and dry the interior thoroughly. To prevent odor and mold growth, leave the door ajar: block it open or have the door removed if necessary.
- Keep the cleaned appliance in a dry, ventilated place and away from the heat source, place the appliance smoothly, and do not place heavy objects on top of it.
- The unit should not be accessible to child's play.

Maintenance and cleaning

! Before cleaning, unplug the power plug first; Do not plug in or plug out the plug with wet hand, because there is a risk of electric shock and injury. Do not spill water directly on the refrigerator, to avoid rust, electricity leakage and accidents. Do not stretch your hands into the bottom of the refrigerator, since you might be scratched by sharp metal corners.

Internal cleaning and external cleaning

The food residuals in the refrigerator are liable to produce bad odor, so the refrigerator must be cleaned regularly. The fresh food compartment is usually cleaned once a month.

Remove all shelves, crisper box, bottle racks, cover board, and drawers etc., and clean them with a soft towel or sponge dipped in warm water or neutral detergent.

Clear off the dusts accumulated on the rear panel and side plates of the refrigerator often.

After using detergent, be sure to rinse it with clean water, and then wipe it dry.

! Do not use bristle brush, steel wire brush, detergent, soap powder, alkaline detergent, benzene, gasoline, acid, hot water and other corrosive or soluble items to cleanse the cabinet surface, door gasket, plastic decorative parts, etc., so as to avoid damage.

Carefully wipe dry the door gasket, clean the groove using a wooden chopstick wrapped with cotton string. After the cleaning, fix the four corners of the door gasket first, and then embed it segment by segment into the door groove.

Interruption of power supply or failure of the refrigerating system

- Take care of the frozen foods in the event of an extended non-running of the refrigerating appliance (such as interruption of power supply or failure of the refrigerating system).
- Try to open the refrigerator door as less as possible, in this way can food safely and freshly kept for hours even in hot summer.
- If you get the power outage notice in advance:
 - 1) Adjust the thermostat knob to the high mode an hour in advance, so that foods get fully frozen (Do not store new food during this time!). Restore the temperature mode to the original setting when power supply becomes normal in a timely manner.
 - 2) You can also make ice with a watertight container, and put it in the upper part of the freezer, so as to extend the time for fresh food to be stored.

! Note: Once the refrigerator is used, you'd better use it continuously; and under normal circumstance, do not stop its use, so as not to affect the service life.

Defrosting

This appliance is designed with automatic defrosting function, thus no need to defrost it manually.

Changing the lamp

The LED lamp is used by the refrigerator for lighting, which features low energy consumption and long service life. In case of any abnormality, please contact the after-sales personnel for visiting service. The lamps can only be replaced by the manufacturer.

Safety-check after maintenance

- Is the power cord broken or damaged?
- Is the power plug firmly inserted into the socket?
- Is the power plug abnormally overheated?

! Note: Electric shock and fire accident may be caused in case the power cord and plugs damaged or stained by dust. If any abnormality, please unplug the power plug and get in contact with the vendor.

Simple fault analysis and elimination

With regard to the following small faults, not every failure needs to be fixed by the technical service personnel; you can try to solve the problem.

Case	Inspection	Solutions
<ul style="list-style-type: none"> • Completely non-refrigeration 	<ul style="list-style-type: none"> • Is power plug off? • Are breakers and fuses broken? • No electricity or line tripping? • Where is the refrigerator installed? Is it placed in balconies, garages, storage rooms and other places where the ambient temperature is below 10°C? 	<ul style="list-style-type: none"> • Re-plug • Opening the door and checking whether the lamp is lit. • Power outage or line tripping? • Install refrigerator in a location that is protected and the ambient temperature is above 10 °C. If your refrigerator is installed in too low t emperature, the internal cooling system may not work correct ly.
<ul style="list-style-type: none"> • Abnormal noise 	<ul style="list-style-type: none"> • Is refrigerator stable? • Does refrigerator reach the wall? 	<ul style="list-style-type: none"> • Adjusting refrigerator's adjustable feet. • Off the wall.

<ul style="list-style-type: none"> • Poor refrigerating efficiency 	<ul style="list-style-type: none"> • Do you put hot food or too much food? • Do you open the door frequently? • Do you clip food bag to the seal of door? • Direct sunlight or near a furnace or stove? • Is it well-ventilated? • Temperature setting in too high? 	<ul style="list-style-type: none"> • Putting food into refrigerator when hot food becomes cool. • Checking and closing the door. • Removing the refrigerator from the heat source. • Emptying the distance to maintain good ventilation. • Setting to the appropriate temperature.
<ul style="list-style-type: none"> • Peculiar smell in refrigerator 	<ul style="list-style-type: none"> • Any spoiled food? • Do you need to clean refrigerator? • Do you pack food of strong flavors? 	<ul style="list-style-type: none"> • Throwing away spoiled food. • Cleaning refrigerator. • Packing food of strong flavors.



Note: If the above descriptions are inapplicable to troubleshooting, do not disassemble and repair it yourself. Repairs carried out by inexperienced persons may cause injury or serious malfunctioning. Contact the local store where your purchase was made. This product should be serviced by an authorized engineer and only genuine spare parts should be used.

When the appliance is not in use for long periods, disconnect from the electricity supply, empty all foods and clean the appliance, leaving the door ajar to prevent unpleasant smells.

Certifications

Electrical information

This electrical appliance must be grounded

This product is equipped with a plug, which is suitable for all houses equipped with sockets meeting the current specifications

If the fitted plug is not suitable for your socket outlets, it should be cut off and carefully disposed of. To avoid a possible shock hazard, do not insert the discarded plug into a socket.

This product complies the EEC directives.

Safe recovery instructions

Disposal

Old appliances still have some surplus value. An environmentally friendly approach will ensure that valuable raw materials are recycled.

The refrigerants used in your equipment and insulation materials require special handling procedures. Make sure there is no pipe damage on the back of the equipment before handling.

Up-to-date information on the options for disposing of old equipment and packaging from old equipment can be obtained from the local municipal office.

Correct Disposal of this product	
	<p>This marking indicates that this product should not be disposed with other household wastes throughout the EU. To prevent possible harm to the environment or human health from uncontrolled waste disposal, recycle it responsibly to promote the sustainable reuse of material resources. To return your used device, please use the return and collection systems or contact the retailer where the product was purchased. They can take this product for environmentally safe recycling.</p>