

Installation Guide Network Disk Recorder

Model No. PM-EN8CH

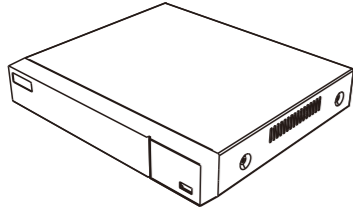

- For information about how to perform the settings and how to operate the device, refer to the operation manual, which can be downloaded from the QR code.
- Before attempting to connect or operate this product, please read these instructions carefully and save this manual for future use.
- HDMI, the HDMI logo and High-Definition Multimedia Interface are trademarks or registered trademarks of HDMI Licensing Administrator, Inc.



PANASONIC MARKETING MIDDLE EAST & AFRICA FZE
PO Box 17985, Dubai UAE
Jebel Ali Free Zone South 2, Dubai, UAE
Tel. NO: (+971) 48007262
Email: customercare@ae.panasonic.com
Website: www.panasonic.com

To download the mobile application, configuration tool and operating manual, please use the QR code.

Warning:

- This apparatus must be earthed.
- Apparatus shall be connected to a main socket outlet with a protective earthing connection.
- The mains plug or an appliance coupler shall remain readily operable.
- To prevent fire or electric shock hazard, do not expose this apparatus to rain or moisture.
- The apparatus should not be exposed to dripping or splashing and that no objects filled with liquids, such as vases, should be placed on the apparatus.
- All work related to the installation of this product should be made by qualified service personnel or system installers.
- For PERMANENTLY CONNECTED APPARATUS provided neither with an all-pole MAINS SWITCH nor an all-all pole circuit breaker, the installation shall be carried out in accordance with all applicable installation rules.
- The connections should comply with local electrical code.
- Store Apparatus in high places or locked cabinets that children cannot access.
- Please ensure that the apparatus and power adapters is installed/kept in a dry place or away from wet areas.
- Ensure that the Apparatus is grounded before powering ON.

Caution:

- Before attempting to connect or operate this product, please read the label on the bottom.
- Ensure the products are powered by the recommended/standard power adapters.
- Keep Apparatus away from small metallic/Non-Metallic objects.

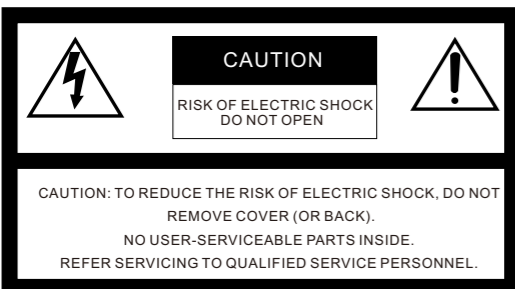

The lightning flash with arrowhead symbol, within an equilateral triangle, is intended to alert the user to the presence of uninsulated "dangerous voltage" within the product's enclosure that may be of sufficient magnitude to constitute a risk of electric shock to persons.

The exclamation point within an equilateral triangle is intended to alert the user to the presence of important operating and maintenance (servicing) instructions in the literature accompanying the appliance.

Power disconnection. Unit with or without ON-OFF switches have power supplied to the unit whenever the power cord is inserted into the power source; however, the unit is operational only when the ON-OFF switch is in the ON position. Unplug the power cord to disconnect the main power for all units.

Limitation of liability

This publication is provided "as is" without warranty of any kind, either express or implied, including but not limited to, the implied warranties of merchantability, fitness for any particular purpose, or non-infringement of the third party's right. This publication could include technical inaccuracies or typographical errors. Changes are added to the information herein, at any time, for the improvements of this publication and/or the corresponding product (s).

Disclaimer of warranty

In no event shall Panasonic be liable to any party or any person, except for replacement or reasonable maintenance of the product, for the cases, including but not limited to below:

- Any loss or damage, including without limitation, direct or indirect, special, consequential or exemplary, arising out of or relating to the product;
- Any inconvenience, loss, or damage caused by inappropriate use or negligent operation of the user;
- All malfunctions or troubles from unauthorized disassemble, repair or modification of the product by the user, regardless of the cause of the malfunction or trouble;
- Inconvenience or any loss arising when images are not displayed, due to any reason or cause including any failure or problem of the product;
- Any problem, consequential inconvenience, or loss or damage, arising out of the system combined by the devices of third party;
- Any claim or action for damages brought by any person or organization as a photographed subject due to violation of privacy concerning a surveillance camera's picture or saved data, for some reason (including use when user authentication on the authentication setting screen is set to off), becoming public or being used for any purpose;
- Loss of registered data caused by any failure (including initialization of the product due to forgotten authentication information such as a user name and password).

Network security

As you will use this unit connected to a network, your attention is called to the following security risks.

- Leakage or theft of information through this unit
- Use of this unit for illegal operations by persons with malicious intent
- Interference with or stoppage of this unit by persons with malicious intent

It is your responsibility to take precautions such as those described below to protect yourself against the above network security risks.

- Use this unit in a network secured by a firewall, etc.
- If this unit is connected to a network that includes PCs, make sure that the system is not infected by computer viruses or other malicious entities (using a regularly updated anti-virus program, anti-spyware program, etc.).
- To prevent unauthorized access, use user-authentication, set user names and passwords, and limit which users can log in.
- Apply measures such as user authentication to protect your network against leakage or theft of information, including image data, authentication information (user names and passwords), alarm E-mail information, FTP server information and DDNS server information.
- After the unit is accessed by the administrator, make sure to close the browser.
- Change the administrator password periodically. Additionally, save user authentication information (user names and passwords) in such a way that it is kept out of the hands of third parties.
- Do not install the apparatus in locations where the apparatus or the cables can be destroyed or damaged by persons with malicious intent.

Important safety instructions

- Heed all warnings.
- Follow all instructions.
- Clean only with dry cloth.
- Do not defeat the safety purpose of the polarized or grounding-type plug. A polarized plug has two blades with one wider than the other. A grounding type plug has two blades and a third grounding prong. The wide blade or the third prong are provided for your safety. If the provided plug does not fit into your outlet, consult an electrician for replacement of the obsolete outlet.
- Protect the power cord from being walked on or pinched particularly at plugs, convenience receptacles, and the point where they exit from the apparatus.
- Only use attachments/accessories specified by the manufacturer.
- Use only with the cart, stand, tripod, bracket, or table specified by the manufacturer, or sold with the apparatus. When a cart is used, use caution when moving the cart/apparatus combination to avoid injury from tip-over.
- Unplug this apparatus during lightning storms or when unused for long periods of time.
- Refer all servicing to qualified service personnel. Servicing is required when the apparatus has been damaged in any way, such as power-supply cord or plug is damaged, liquid has been spilled or objects have fallen into the apparatus, the apparatus has been exposed to rain or moisture, does not operate normally, or has been dropped.

Precautions

Power source

The input power source for this product is 48V~54V DC. Do not connect to the outlet that provides the power to equipment that requires a measurable amount of power (such as a copy machine, air conditioner, etc.).
*The provided power cord(s) is (are) dedicated to the use with this product.

Ambient operating temperature

Use this product at temperatures between -10 °C to +50 °C. Failure to do so may damage the internal parts or cause malfunction.
* Performance and lifetime of hard disk drives are easily affected by heat (used at high temperature). It is recommended to use this product at a temperature of approx. +25 °C.

To cut the power supply

This product has no power switch. To cut the power supply, unplug the power plug of the product from the AC outlet. If it is hard to unplug the power cord due to the installation conditions, connect the power cord of the product to the AC outlet via the circuit breaker of a distribution board or to the AC inlet socket of a power supply control unit.

Prevent condensation from forming

If this happens, it can cause malfunction. Leave it switched off for around 2 hours in the following cases.

- When this product is placed in an extremely humid place.
- When this product is placed in a room where a heater has just been turned on.
- When this product is moved from an air-conditioned room to a humid and high-temperature room.

About the monitor

When displaying the same image on the monitor for a long time, the monitor may be damaged.

Hard disk drive (HDD)

Hard disk drives are vulnerable to vibration. Handle them with care. It is possible to damage them if they are moved while their motors are still running.

When this product is not supposed to be used for a certain period

Turn on the power (around once a week), and perform recording/playback to prevent interferences with functions.

Handle this product with care

Do not strike or shake or give a strong shock to this product, as this may damage this product or allow water to enter this product.

Front and rear view

Front view

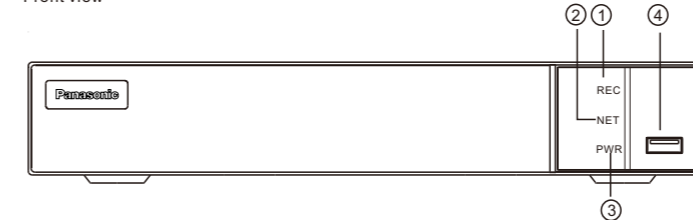

- REC: lights blue when recording is being performed.
- NET: lights blue when it is access to a network.
- PWR: lights blue when the power is on.
- USB port: To connect external USB device, like USB mouse or USB flash drive.

Rear view

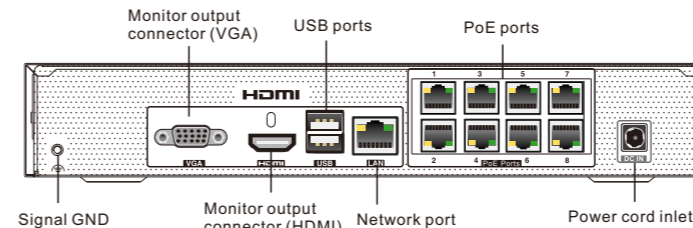

- Signal GND:** Connect this terminal with the Signal GND terminals of the devices in the system for signal ground. When operating the recorder and the devices in the system without signal ground, oscillation or noise may be produced.
- Monitor output connector (VGA/HDMI):** This connector is used to connect to an VGA/HDMI ready monitor (the main monitor). VGA and HDMI output the same video source.
- USB ports:** To connect external USB device, like USB mouse or USB flash drive.
- Network port (10/100M):** Use this port to connect the recorder to a network. When the port is being accessed and linked, the orange light blinks and the green light is steady on.
- PoE ports:** Directly connect to 8 PoE network cameras. When the PoE ports are accessed and linked, the orange light blinks and the green light is steady on.
- Power cord inlet [DC IN]:** Connect the provided power cord to this inlet.

Precautions for installation

This product is designed to be used indoors.

Panasonic assumes no responsibility for injuries or property damage resulting from failures arising out of improper installation or operation inconsistent with this documentation.

Do not place this product in the following places:

- Locations exposed to direct sunlight
- Locations subject to having strong vibration or impact
- Locations near magnetic field sources such as a television or speakers
- Locations where condensation forms easily, where temperature changes greatly or where humidity level is high
- Locations subject to steam and oil smoke such as a kitchen
- Locations which are not level
- Locations subject to dust
- Locations where it may get wet from rain or water splash

Do not install this product in locations where the product or the cables can be destroyed or damaged by persons with malicious intent.

Place this product horizontally on a level surface.

Do not place this product in an upright position. In addition, clear a space of approx. 5 cm from the both sides, the top, the bottom and the rear.

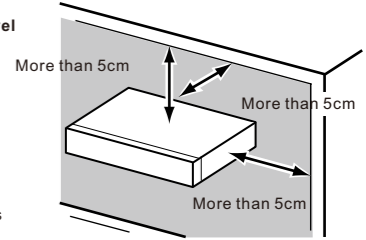

Heat dissipation

To prevent this product from overheating, heed the following. Failure to observe this may cause fire or trouble.
• Do not block the ventilation openings. Maintain the product periodically to prevent dust from blocking openings.
• The lifetime of the cooling fan is limited by use. It is recommended to replace them after around 30000 hours of operation. Contact your dealer for replacement of the cooling fans.
• Clear a space of more than 5 cm from both sides, the top, and the rear of the product. Do not block the ventilation openings on the front side since this product is designed to cool the hard disk drives by inhaling air from the front.

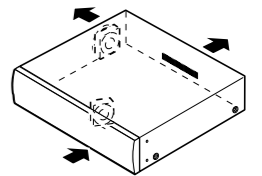

Avoid placing this product near noise sources

If the cables are placed near noise sources such as fluorescent lamps, noises may be produced. In this case, rewire avoiding the noise sources, or move the product to a place far from the source.

Grounding

Confirm that the wire is connected from the SIGNAL GND terminal to earth ground. A grounding connection must be made before connecting the power plug or this product to the main power supply. When disconnecting the grounding wire, make sure that the power plug of this product is disconnected from the main power supply.

Connection

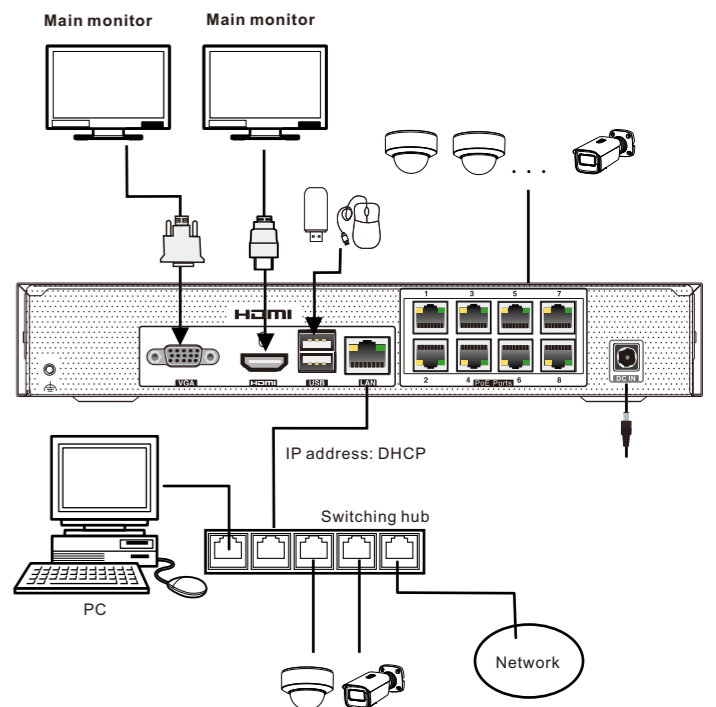

Max. 8 cameras can be accessed to the NVR (either via PoE ports or network).

Installation or replacement of HDDs

This series of the product supports 1 SATA hard drive. Please make sure that the device is powered off before the installation. The pictures of the installation are only for reference.

- Loosen the screws on the side panel to open the cover.

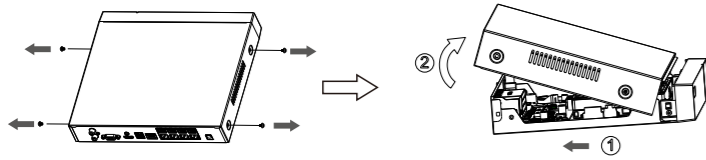

- Put the HDD on the bottom of the device.
- Turn over the machine and secure the HDD with the screws.

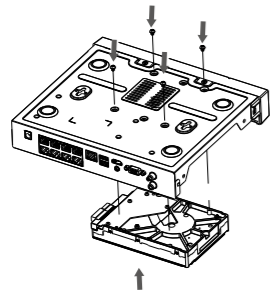

- Connect the power and data cables.

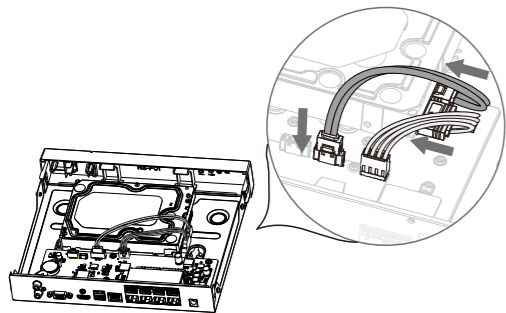

- Install back the cover and secure it with the screws.

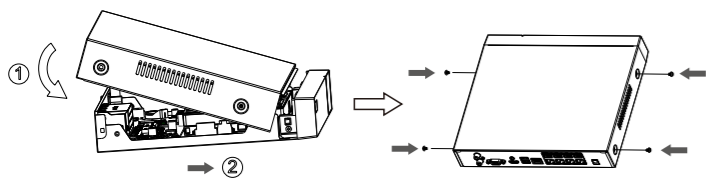

Tips: Please check the inside structure of the device and make sure the cables connected well before installing the cover back. Please format the HDD before using.

Startup & Shutdown

► Startup

Connect the monitor and the power.
The device will boot. Please wait for a while.
A wizard window will pop up.

► Shutdown

Click "Start" and then select "Shutdown" icon. This will bring up a shutdown window. The device will shut down after entering the username and password. Then follow the direction to disconnect the power.

System Login

You must configure the wizard if you start the NVR for the first time. Choose the language and read the privacy statement. Then set the data, time and zone as needed. After that, set the login password.

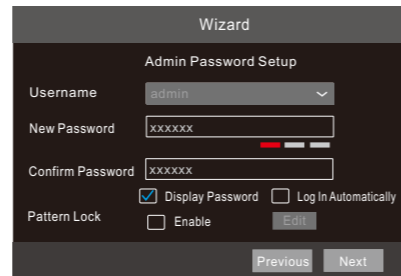

The default username is *admin*. Set your own password when you use the wizard for the first time. Enable pattern lock and click "Edit" to set the pattern lock. Then set security questions and answers. It is important for you to remember these answers, or you will not be able to reset your password. Click "Next" to continue.

Disk Settings

You can view the disk number, disk capacity of the NVR and serial number, Read/Write status of the disk. Click "Format" to format the disk. Click "Next" to continue.

Network Configuration & Add IP Camera

- Enter IP address, subnet mask, gateway, etc. If using DHCP, please enable DHCP in both the NVR and the router.

The internal ethernet port is the port which connects all the PoE ports with the NVR system. The PoE ports are available if the internal ethernet port is online; if it is offline, all the PoE ports will be unavailable.

Mode: Non-long line mode or long line mode can be selectable. If the transmission performance of your network cables connected the PoE ports and IPC are not so good or these network cables are very long, you can choose long line mode.

- Enter HTTP/HTTPS port and server port as needed.

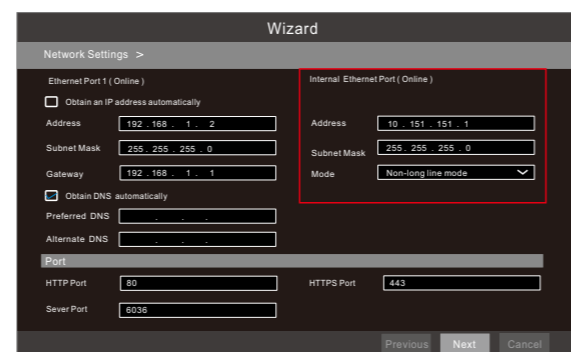

- Add Camera. Click "Next" to go to the following interface.

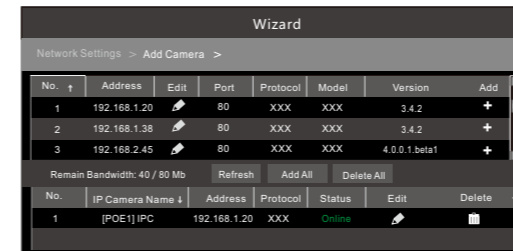

Click "Refresh" to refresh the list of online IP cameras which are in the same local network with the NVR. Click + to add the searched camera. Click "Add All" to add all the cameras in the list. Click [X] to delete the added camera. Click "Delete All" to delete all the added cameras.

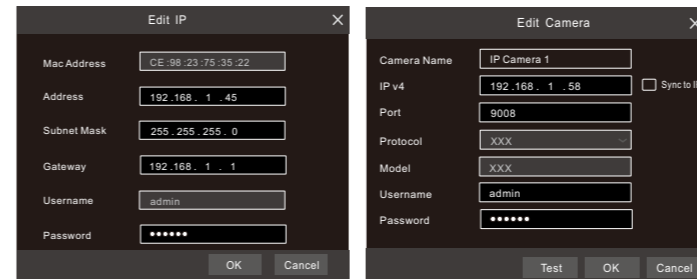

- Click [X] to edit an IP camera as shown on the above left. Enter the new IP address, subnet mask, gateway, username and password of the camera. Click "OK" to save the settings.

Click [X] to edit the added camera as shown on the above right. Enter the new camera name, IP address, port, username and the password of the camera. You can click "Test" to test the effectiveness of the input information. Click "OK" to save the settings. You can change the IP camera name only when the added camera is online. Click "Next" to continue.

Record Settings

Two record modes: auto and customization.

Auto Mode: Select one auto mode in the interface as shown below and then click "Next" to save the settings. Click "Advanced" to self-define a record mode.

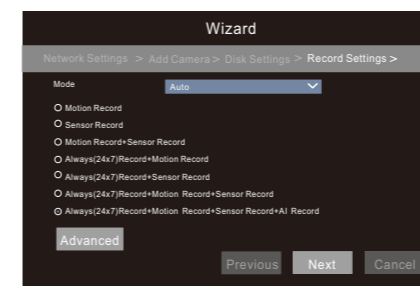

Customization Mode: Set the "Sensor Record", "Motion Record", "AI Record", "POS Record" and "Schedule Record" of each camera. Please enable the record as needed. Click "Next" to continue.

NAT

You can enable the NAT function in the interface or set it in the network configuration after exiting the wizard. You can scan the QR code through the mobile surveillance APP available for iOS or Android to easily view your cameras. Please see the user manual of NVR for more details.

► Web Access Through NAT Function

Go to Start → Settings → Network → NAT tab. Enable NAT and select the NAT access type (NAT1.0 or NAT2.0). Click "Apply" to save the parameters.

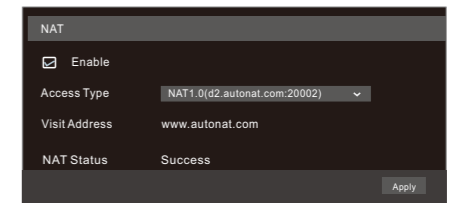

Enter the visit address in the address bar of your browser and then press enter to go to the following interface. If you are the first time to access the NAT, you shall download and install the plug-in according to the popup tips. After installing the plug-in successfully, it will appear the login box.

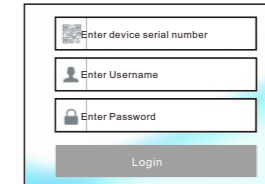

Device Serial Number: Click Start→Settings→Network→NAT to check the serial number.
Username: The username of the NVR. The default username is admin.
Password: The password of the NVR. The password is set by yourself when you configure the wizard for the first time.

Cloud Upgrade

Before using this function, please enable NAT2.0. Then click "Cloud Upgrade" in the wizard interface. Go to Start → Settings → Network → Cloud Upgrade interface and click "Upgrade" to upgrade your device if it is not the latest version.

Manual Recording

Before recording, please install a HDD. In the live interface you can see the menu toolbar. Click [Record] button to start recording. Click it again to stop recording. You can also click [Status] to check the status of the recording.



Playback

► Instant playback

Click [Instant Playback] on the tool bar at the bottom of the preview camera window to play back the record from 5 minutes ago or right click to select "Instant Playback" and then select the instant playback time to play back the record.

► General playback

Click [General Playback] on the tool bar at the bottom of the live view interface or click Start → Playback to go to the playback interface as shown below. You can also add the playback cameras manually. Click [Add] in the playback window to pop up the "Add Camera" window. Check the cameras in the window and then click "Add" to add playback camera. The record files of the added playback camera will be played in the playback interface.

