

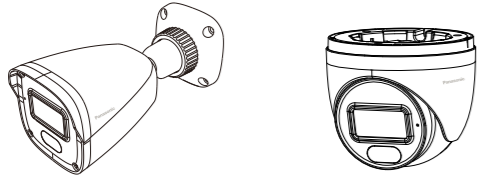

Installation Guide Network Camera

Model No. PM-EB2NLFR-W/PM-ED2NLFR-W



- For information about how to perform the settings and how to operate the camera, refer to the operation manual, which can be downloaded from the QR code.
- Before attempting to connect or operate this product, please read these instructions carefully and save this manual for future use.

PANASONIC MARKETING MIDDLE EAST & AFRICA FZE
 PO Box 17985, Dubai UAE
 Jebel Ali Free Zone South 2, Dubai, UAE
 Tel.NO: (+971) 48007262
 Email: customercare@ae.panasonic.com
 Website: www.panasonic.com

Warning:

- To prevent injury, this apparatus must be securely attached to the wall/ceiling in accordance with the installation guide.
- All work related to the installation of this product should be made by qualified service personnel or system installers.
- The installation shall be carried out in accordance with all applicable installation rules.
- The connections should comply with local electrical code.
- Store Apparatus in high places or locked cabinets that children cannot access.

Caution:

- Any changes or modifications not expressly approved by the party responsible for compliance could void the user's authority to operate the equipment.
- The network camera is only intended for a connection to an ethernet or PoE network without routing to the outside plant.

Disposal of old equipment
 Only for European Union and countries with recycling systems



These symbols on the products, packaging, and/or accompanying documents mean that used electrical and electronic products must not be mixed with general household waste. For proper treatment, recovery and recycling of old products, please take them to applicable collection points in accordance with your national legislation. By disposing of them correctly, you will help to save valuable resources and prevent any potential negative effects on human health and the environment.

For more information about collection and recycling, please contact your local municipality. Penalties may be applicable for incorrect disposal of this waste, in accordance with national legislation.

Main functions

- 2 MP Full-HD network camera
- H.265+, H.265, H.264+ and H.264 encoding
- Wide-angle lens with day/night functionality and built-in IR & white light-LED

Important safety instructions

- 1) Read these instructions.
- 2) Keep these instructions.
- 3) Heed all warnings.
- 4) Follow all instructions.
- 5) Do not block any ventilation openings. Install in accordance with the manufacturer's instructions.
- 6) Do not install near any heat sources such as radiators, heat registers, stoves, or other apparatus (including amplifiers) that produce heat.
- 7) Only use attachments/accessories specified by the manufacturer.
- 8) Unplug this apparatus during lightning storms or when unused for long periods of time.
- 9) Refer all servicing to qualified service personnel. Servicing is required when the apparatus has been damaged in any way, such as power-supply cord or plug is damaged, liquid has been spilled or objects have fallen into the apparatus, the apparatus has been exposed to rain or moisture, does not operate normally, or has been dropped.

Limitation of liability

This publication is provided "as is" without warranty of any kind, either express or implied, including but not limited to, the implied warranties of merchantability, fitness for any particular purpose, or non-infringement of the third party's right. This publication could include technical inaccuracies or typographical errors. Changes are added to the information herein, at any time, for the improvements of this publication and/or the corresponding product (s).

Disclaimer of warranty

In no event shall Panasonic be liable to any party or any person, except for replacement or reasonable maintenance of the product, for the cases, including but not limited to below:

- (1) Any loss or damage, including without limitation, direct or indirect, special, consequential or exemplary, arising out of or relating to the product;
- (2) Any inconvenience, loss, or damage caused by inappropriate use or negligent operation of the user;
- (3) All malfunctions or troubles from unauthorized disassemble, repair or modification of the product by the user, regardless of the cause of the malfunction or trouble;
- (4) Inconvenience or any loss arising when images are not displayed, due to any reason or cause including any failure or problem of the product;
- (5) Any problem, consequential inconvenience, or loss or damage, arising out of the system combined by the devices of third party;
- (6) Any claim or action for damages brought by any person or organization as a photographed subject due to violation of privacy concerning a surveillance camera's picture or saved data, for some reason (including use when user authentication on the authentication setting screen is set to off), becoming public or being used for any purpose;
- (7) Loss of registered data caused by any failure (including initialization of the product due to forgotten authentication information such as a user name and password).

Network security

As you will use this unit connected to a network, your attention is called to the following security risks.

- ① Leakage or theft of information through this unit
- ② Use of this unit for illegal operations by persons with malicious intent
- ③ Interference with or stoppage of this unit by persons with malicious intent

It is your responsibility to take precautions such as those described below to protect yourself against the above network security risks.

- Use this unit in a network secured by a firewall, etc.
- If this unit is connected to a network that includes PCs, make sure that the system is not infected by computer viruses or other malicious entities (using a regularly updated anti-virus program, anti-spyware program, etc.).
- To prevent unauthorized access, use user-authentication, set user names and passwords, and limit which users can log in.
- Apply measures such as user authentication to protect your network against leakage or theft of information, including image data, authentication information (user names and passwords), alarm E-mail information, FTP server information and DDNS server information.
- After the unit is accessed by the administrator, make sure to close the browser.
- Change the administrator password periodically. Additionally, save user authentication information (user names and passwords) in such a way that it is kept out of the hands of third parties.
- Do not install the camera in locations where the camera or the cables can be destroyed or damaged by persons with malicious intent.

Precautions



- Refer installation work to the dealer. Installation work requires technique and experiences. Failure to observe this may cause fire, electric shock, injury, or damage to the product.
 - Be sure to consult the dealer.
- Turn the power off when do wiring of this product. Failure to observe this may cause electric shock. In addition, short circuit or wrong wiring may cause fire.
- Correctly perform all wiring. Short circuits in the wiring or incorrect wiring may cause fire or electrical shock.
- Stop the operation immediately when something is wrong with this product. When smoke goes up from the product, the smell of smoke comes from the product, or the exterior of the product has deteriorated, continued use will cause a fire or fall of the product resulting in injury, or damage to the product.
 - In this case, turn the power off immediately and contact qualified service personnel for service.
- Select an installation area that can support the total weight. Selecting an inappropriate installation surface may cause this product to fall down or topple over, resulting in injury or accidents. Installation work shall be started after sufficient reinforcement. Periodic inspections shall be conducted. Rust on the metal parts or screws may cause a fall of the product resulting in injury or accidents.
 - Consult the dealer for the inspections.
- To prevent from the risk of short circuit/smoke/fire incident/corrosion of the wiring. It has been suggested to use protective measures/armour, for the cables which are installed underground.
- Do not install this product in locations subject to vibration. Loosening of mounting screws or bolts may cause a fall of the product resulting in injury or accidents.
- Install this product in a location high enough to avoid people and objects from bumping the product. Failure to observe this may cause injury.
- Do not attempt to disassemble or modify this product. Failure to observe this may cause fire or electric shock. Consult the dealer for the repair or inspections.
- The screws and bolts must be tightened to the specified torque. Failure to observe this may cause a drop resulting in injury or accidents.
- Do not insert any foreign objects. Fire or electrical shock may be caused if water or any foreign objects, such as metal objects, enter inside the unit. Turn the power off immediately and contact qualified service personnel for service.
- Do not use this product in an inflammable atmosphere. Failure to observe this may cause an explosion resulting in injury.
- Avoid installing this product in the locations where salt damage occurs or corrosive gas is produced. Otherwise, the mounting portions will deteriorate and accidents such as a fall of the product may occur.
- Do not strike or give a strong shock to this product. Failure to observe this may cause fire or injury.
- Do not install or clean the camera, or touch this product, the power cable or the connected cables during thunder storms. Failure to observe this may cause electric shock.



- Turn the power off when cleaning this product. Failure to observe this may cause injury.

Precautions for use

This product has no power switch. When turning off the power, disconnect the power supply from the PoE device. To keep on using with stable performance Do not use this camera in hot and humid conditions for a long time. Failure to observe this causes component degradation resulting in life shortening of this product. Do not expose this camera to direct heat sources such as a heater. Do not touch the lens with your bare hands. A dirty lens causes deterioration of picture quality. Handle this camera with care. Do not drop this camera, nor apply shock or vibration to this camera. Failure to observe this may cause trouble. If a strong shock or vibration is applied to the enclosure, it may cause damage or allow water to enter this product. Product disposal/transfer Data saved on this product or a storage device used with this product may lead to personal information leakage. When it is necessary to dispose or give this product to someone, even when for repair, make sure that there is no data on this product. When abandoning the memory media, it is recommended to destroy it physically after deleting data by PC.

Cleaning this product body Be sure to turn off the power before cleaning. Failure to observe this may cause injury. Do not use benzene, thinner, alcohol, or any other types of solvents or detergents. Otherwise, it may cause discoloration. When using a chemical cloth for cleaning, read the caution provided with the chemical cloth product. About the MOS image sensor

- When continuously shooting a bright light source such as a spotlight, the color filter of the MOS image sensor may have deteriorated and it may cause discoloration. Even when changing the fixed shooting direction after continuously shooting a spotlight for a certain period, the discoloration may remain.
- When shooting fast-moving subjects or performing panning/tilting operations, objects crossing the shooting area may look to be bending askew.

Equipment classification label Refer to the indication label on the bottom side of this unit for the equipment classification, and other information.

Standard accessories

Confirm the following items are included in the camera's packaging.

Installation Guide (this document)..... 1pc.	Template..... 1pc.
RJ 45 waterproof connector 1 bag.	Screws and screw anchors 1 bag

Connection

◆ Device external cable

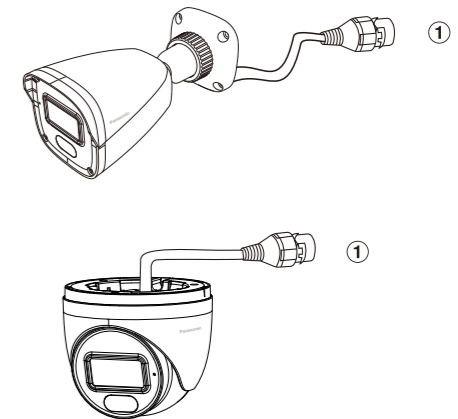

Port	Port name	Note
Port ①	LAN (Network port)	RJ 45 waterproof jack. Connect to standard Ethernet cable. NOTE: Supports PoE power supply

◆ Assembling RJ 45 waterproof connector

Important:

- The maximum cable length is 100 m.
- Make sure that the PoE device in use is compliant with IEEE802.3af standard.
- Use all 4 pairs (8 pins) of the Ethernet cable.
- The external dimensions of the Ethernet cable are ø5 mm to ø6.5 mm.
- If the procedure for the RJ45 waterproof connector (accessory) part is not correctly followed, the waterproofing may be compromised. Do not install the camera where the RJ45 waterproof connector is exposed to constant rain or moisture.

- Attach the rubber ring (accessory) to the RJ 45 waterproof jack connected to the camera as shown.
 - Attach with the flat surface of the rubber ring facing the RJ45 waterproof jack.

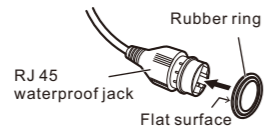

- First pass the Ethernet cable through the RJ 45 waterproof connector cap (accessory), the inner rubber (accessory) and then RJ45 waterproof connector cover (accessory). Next, use a specialized tool (locally procured) to crimp the RJ45 plug (locally procured) to the end of the Ethernet cable.
 - Pass the inner rubber over the cable so that the grooved surface faces the RJ45 plug and the flat surface faces the Ethernet cable.

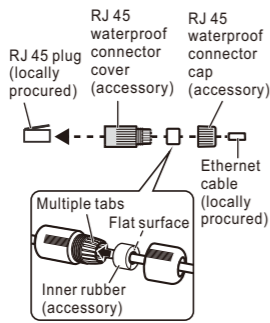

- Insert the inner rubber into the far end of the waterproof connector cover (the direction in which multiple tabs are open) to secure it temporarily inside the multiple tabs.

The following steps illustrate how to attach the connector to a camera as it is being installed.

- Connect the RJ45 plug to the RJ45 waterproof jack and then rotate and tighten firmly the RJ45 waterproof connector cover.
- Connect the RJ45 waterproof connector cap to the RJ 45 waterproof connector cover and rotate the RJ45 waterproof connector cap until there is no gap between it and the RJ45 waterproof connector cover.

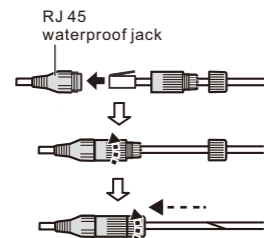

PM-EB2NLFR-W

◆ Framework and dimension

Please refer to the following figure for dimension information.

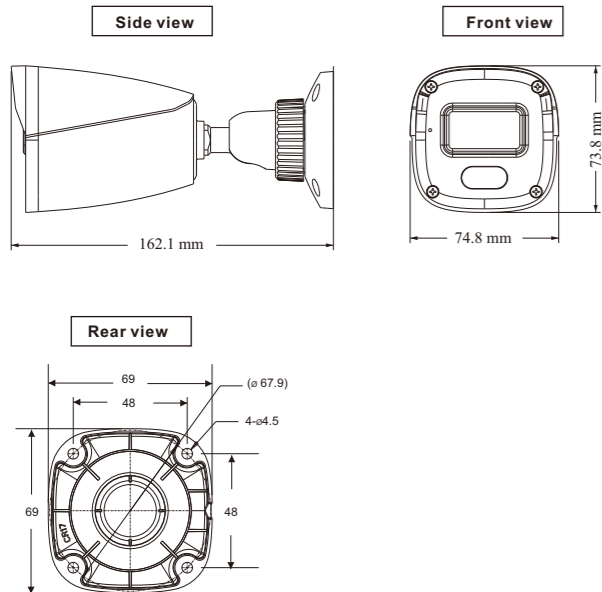

◆ Device Installation

Secure the camera with 4 screws (PA4) (accessory).

- Important:**
- Before starting the connection, turn off the power of the devices to be connected.
 - Use 4 screws (PA4) to secure the camera to a ceiling or a wall, according to the material of the installation area. In this case, wood screws and nails should not be used.
 - Required pull-out capacity of a single screw is 196 N {44 lbf} or more.

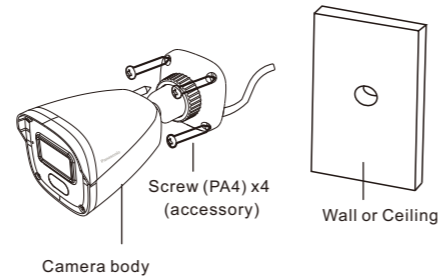

Step 1 Open a hole for cabling in the ceiling or wall.

Remove the template from the carton box and use it to open holes in the positions for installation screws and the center position to pass cabling through.

Note:

- Determine the screw hole diameter based on screw specifications.
- As the cabling hole diameter, open a hole in the center of the base portion of the camera.

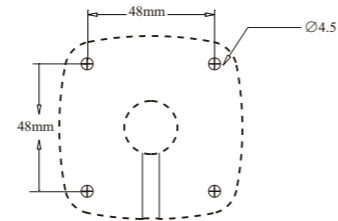

Step 2 Connect the camera.

Connect the RJ45 waterproof connector to the camera's RJ45 waterproof jack. (Refer to steps ④ and ⑤ in "Assembling RJ45 waterproof connector".)

Step 3 Installing the camera.

Loosen the locking ring and fix the camera to the ceiling or wall with four screws (PA4) while panning and tilting of the camera as shown below.

Note:

After connection, push extra cabling through the hole in the ceiling or wall to adjust the length.

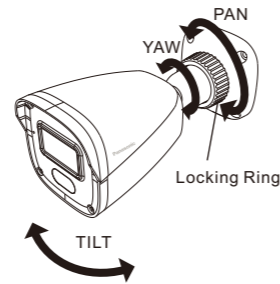

Step 5 Turn the power on and check the screen on the computer.

Turn on power from PoE device and operate the camera. Check video from the camera on the computer screen and refer to "Network Configuration" on the right side of this document.

Step 6 Adjust the camera angle.

Adjust the camera angle as you check video on the computer screen. Turn the base of the camera to PAN, or move the camera itself to adjust TILT or YAW, as shown above. Finally, tighten the locking ring to secure the camera's position.

PM-ED2NLFR-W

◆ Framework and dimension

Please refer to the following figure for dimension information.

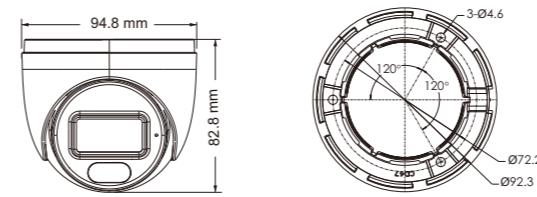

Secure the camera with 3 screws (PA4) (accessory).

Important:

- Before starting the connection, turn off the power of the devices to be connected.
- Use 3 screws (PA4) to secure the camera to a ceiling or a wall, according to the material of the installation area. In this case, wood screws and nails should not be used.
- Required pull-out capacity of a single screw is 196 N {44 lbf} or more.

Step 1 Open a hole for cabling in the ceiling or wall.

Remove the template from the carton box and use it to open holes in the positions for installation screws and the center position to pass cabling through.

Note:

- Determine the screw hole diameter based on screw specifications.
- As the cabling hole diameter, open a hole in the center of the base portion of the camera.

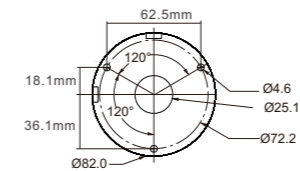

Step 2 Remove the mounting base.

Rotate the mounting base and make sure the marks of mounting base and enclosure are aligned. Then remove the mounting base.

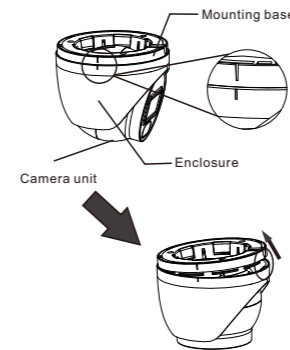

Step 3 Connect the camera.

Connect the RJ45 waterproof connector to the camera's RJ45 waterproof jack. (Refer to steps ④ and ⑤ in "Assembling RJ45 waterproof connector".)

Step 4 Attach the camera to the ceiling or wall.

Attach the camera using the three screws (accessory) on the ceiling or wall.

After connection, push extra cabling through the hole in the ceiling or wall to adjust the length.

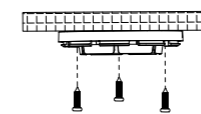

Step 5 Turn the power on and check the screen on the computer.

Turn on power from PoE device and operate the camera. Check video from the camera on the computer screen and refer to "Network Configuration" on the right side of this document.

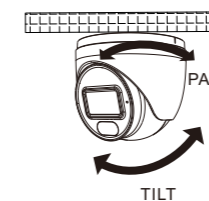

Step 6 Adjust the camera angle.

Install the enclosure and camera unit back to the mounting base. Then adjust the camera angle as you check video on the computer screen. Turn the camera unit to obtain an optimum viewing angle.

Network Configuration

Configure the setting of the camera after temporarily invalidating the firewall software. Once the camera configuration is completed, return to the original state. Contact the network administrator or your Internet service provider for information about configuring the settings of the network.

- Get the Panasonic IP Manager Tool from your supplier and install it in your PC.

- Double click the Panasonic IP Manager Tool icon to run it.

The IP address/model of the detected camera will be displayed automatically. Click the searched device and then its MAC address will be displayed on the right hand.

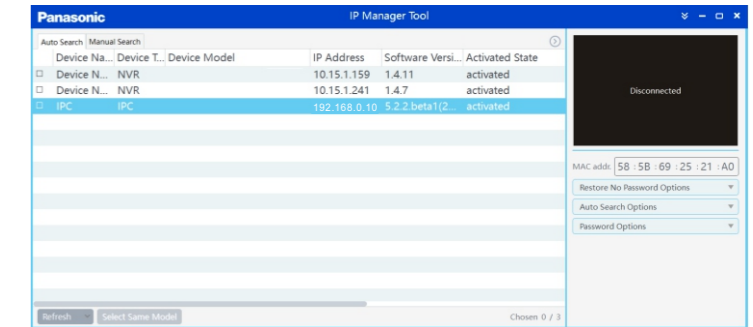

- Select the camera you want to configure, and double click it.

Select the camera with the same MAC address as the MAC address printed on the camera that you want to configure. Double click the camera information to open a web browser to connect the camera. After you read the privacy statement, check and click "Already Read". Follow directions to activate the camera.

- When the device activation window is displayed, enter "Username", "Password" and "Confirm Password" by following the instructions displayed on the screen.

After completing the activation settings, the camera will automatically be re-connected and the login window will be displayed. Enter the registered username and password. The default username is "admin". Set security questions and answers as needed. It is very important for you to set them. You can reset your password through these questions and answers. Please remember these answers.

- Follow directions to download and install the plug-in if prompted on the screen.

- When the live video of the camera is displayed, the network access is complete.



To download the configuration tool and operating manual, please use the QR code.