

Panasonic®

Operating Instructions for advanced features

Digital Camera

Model No. **DC-GX9**



LUMIX

Please read these instructions carefully before using this product,
and save this manual for future use.

Message displays →322

Q&A Troubleshooting →324

Finding the information you need →2

Contents →5

Contents by Function →11







Names and Functions of Main Parts →16

Menu list →188

Finding the information you need

In this “Operating Instructions for advanced features”, you can find the information you need from the following pages.

By clicking a page number, you can jump to the linked page and quickly find the information.

Search from “Contents”	 5 -
Search from the list of function names “Contents by Function”	 11 -
Search from “Names and Functions of Main Parts”	 16 -
Search from “List of monitor/viewfinder displays”	 315 -
Search from the list of on-screen messages “Message displays”	 322 -
Search from the menu list	 188 -
Search from “Q&A Troubleshooting”	 324 -

For details on how to use this manual, see the next page.



Recording mode icons

Recording mode:   **P** **A** **S** **M**   

In Recording modes that show icons in black, you can select and execute indicated menus and functions.

 (Custom Mode) has different functions depending on the recording mode that is registered.

- Click a cross reference in the text to jump to the corresponding page.
- Description in these operating instructions is based on the interchangeable lens (H-FS12032).



Click this icon to jump to "Finding the information you need".



Click this icon to jump to "Contents".



Click this icon to jump to "Menu list".



Click this icon to return to the previously displayed page.



■ About the symbols in the text

MENU Indicates that the menu can be set by pressing [MENU/SET] button.

Wi-Fi Indicates that the Wi-Fi setting can be made by pressing [Wi-Fi] button.

 Tips for skilful use and points for recording.

(→00) Indicates the reference page. Click to go to the corresponding page.

Steps for setting a menu item are described as follows:



Example: To change the [Quality] setting to [.] in the [Rec] menu

MENU →  **[Rec]** → **[Quality]** → [.]

• This operating instructions express the up, down, left, and right of the cursor button as ▲▼◀▶.

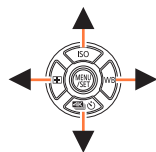
• Dial operations are illustrated as below.



Turn the front dial	
Rotate the rear dial	
Press the rear dial	



- Finding the information you need 2
- How to use this manual 3
- Contents by Function 11

Before Use

- Before use 13
- Standard Accessories 15
- Names and Functions of Main Parts 16
- About the Lens 20

Preparations

- Attaching the Shoulder Strap 21
- Charging battery 22
 - Inserting the battery 23
 - Charging the battery 24
- Inserting and removing the card (optional) 32
- About the Card 33
 - Formatting the card (initialisation) 34
 - Estimated recording capacity (number of pictures/recording time) 34
- Attaching/Removing the Lens 36
- Setting the clock 40

Basics

- Holding the camera 42
- Adjusting the angle of the monitor and viewfinder 44
- Buttons/Dials Used for Recording 45
 - [LVF] button (Recording pictures using the viewfinder) 45
 - Shutter button (Taking pictures) 46
 - Motion picture button (Recording motion pictures) 46
 - Mode dial (Select the recording mode) 47
 - Front Dial/Rear Dial 47
 - Cursor button / [MENU/SET] button (Selecting/setting items) 50
 - [DISP.] button (Switching the display information) 50
- Touch screen (Touch operations) 53
 - Focusing on the subject at the touched position (Touch AF, Touch Shutter) 54
 - Matching the brightness to the touched position (Touch AE) 55
- Setting the menu 56
- Calling frequently-used menus instantly (Quick Menu) 58
 - Change the Quick Menu to your preferred item 59
- Assigning frequently used functions to the buttons (Function buttons) 60
 - Using the function buttons during recording 61
 - Using the function buttons during playback 62
- Entering Text 63



Recording mode

- **Taking pictures with automatic settings (Intelligent Auto Mode) 64**
 - [Intelligent Auto] menu 66
 - Setting colouring 67
 - Setting brightness (exposure)/ blurriness of the background (Defocus control function) 68
- **Taking pictures after automatically setting the aperture value and shutter speed (Programme AE Mode) 69**
- **Taking pictures by setting the aperture value and shutter speed ... 70**
 - Taking pictures by setting the aperture value (Aperture-Priority AE Mode) 70
 - Taking pictures by setting the shutter speed (Shutter-Priority AE Mode) 71
 - Taking pictures by setting the aperture value and shutter speed (Manual Exposure Mode) 72
 - Checking the effects of the aperture value and shutter speed (Preview Mode) 74
 - Easily set aperture value / shutter speed for suitable exposure (One Push AE) 75
- **Recording panorama pictures (Panorama Shot Mode) 76**
- **Taking pictures according to the scene (Scene Guide Mode) 79**
 - Types of Scene Guide Mode 80
- **Taking Pictures with different picture effects (Creative Control Mode) 83**
 - Types of picture effects 84
- **Recording motion pictures by setting the aperture/ shutter speed/ISO sensitivity (Creative Video Mode) 89**
 - Pan or zoom while recording with the camera in a fixed position ([4K Live Cropping]) 91
- **Registering your own settings and recording (Custom Mode) 93**
 - Registering your own settings ([Cust.Set Mem.]) 93
 - Recording using registered custom set 94



Focus, Brightness (Exposure) and Colour tone Settings

- **Taking pictures with Auto Focus..... 95**
 - Set the Focus Mode (AFS, AFF, AFC).....96
 - Switching [AF Mode].....97
 - Changing the position and size of the AF area103
 - Setting the AF area position with the touch pad.....106
 - Optimising the focus and brightness for a touched position107
- **Taking pictures with Manual Focus 108**
- **Taking pictures by locking the focus and/or exposure (AF/AE Lock)111**
- **Taking pictures with Exposure Compensation..... 112**
- **Setting the ISO Sensitivity 114**
- **Adjusting the White Balance 116**

4K Photo and Drive Settings

- **Recording with the 4K Photo function and selecting pictures to save..... 120**
 - Recording with the 4K Photo function120
 - Selecting pictures from 4K burst file and saving124
 - Notes on the 4K Photo function129
- **Adjusting the focus after recording ([Post Focus]/[Focus Stacking]).... 132**
 - Recording using [Post Focus].....132
 - Select the focus point and save the picture ([Post Focus]).....134
 - Select the focus range to combine and create a single picture ([Focus Stacking]).....135
 - Notes on the [Post Focus]/[Focus Stacking]136
- **Selecting a Drive Mode..... 137**
 - Burst function.....138
 - Taking pictures with self-timer.....140
- **Taking Pictures While Adjusting a Setting Automatically (Bracket Recording)..... 141**
 - Exposure Bracket142
 - Aperture Bracket.....143
 - Focus Bracket.....144
- **Taking pictures automatically at set intervals [Time Lapse Shot]..... 145**
- **Creating stop motion animation [Stop Motion Animation] 148**



Stabiliser, Zoom and Flash

- **Correcting jitter** 151
 - Setting the focal length of a lens 153
- **Using Zoom** 155
 - Optical Zoom 155
 - Raising the telescopic effect 156
 - Changing the settings for a power zoom lens 159
 - Using the zoom by performing touch operations (Touch zoom) 160
- **Taking pictures with flash** 161
- **Setting the Flash Functions** 163
 - Changing the firing mode (Manual flash) 163
 - Changing Flash Mode 164
 - Setting the 2nd curtain sync 166
 - Adjusting the flash output 167
 - Synchronising the flash output with the camera during Exposure Compensation 167
- **Taking Pictures with Wireless Flashes** 168

Recording motion pictures

- **Recording Motion Picture/4K Motion Picture** 171
 - Setting the format, picture size and recording frame rate 173
 - Adjusting the focus while recording motion pictures ([Continuous AF]) 175
- **Taking still pictures while a motion picture is being recorded** 176
- **Recording Snap Movies** 177

Playing Back and Editing Pictures

- **Viewing your pictures** 180
- **Viewing motion pictures** 181
 - Capturing still pictures from motion pictures 182
- **Switching the Playback Method** 183
 - Zooming in and viewing "Playback Zoom" 183
 - Viewing a list of pictures "Multi Playback" 183
 - Viewing pictures by their recording date "Calendar Playback" 184
- **Viewing group pictures** 185
- **Deleting pictures** 187



Using Menu Functions

Menu list	188	[Setup]	223
[Rec]	189	[My Menu]	234
[Motion Picture]	205	[Playback]	235
[Custom]	207		

Wi-Fi/Bluetooth

What you can do with the Wi-Fi®/Bluetooth® function	252	Displaying still pictures on a TV	275
Wi-Fi/Bluetooth Function	253	Sending pictures	276
Connecting the camera to a smartphone	256	Sending pictures to a smartphone	279
Installing the smartphone/tablet app "Panasonic Image App"	256	Wireless printing	280
Connecting the camera to a smartphone compatible with Bluetooth Low Energy	257	Sending pictures to AV device	281
Connecting the camera to a smartphone that does not support for Bluetooth Low Energy	260	Sending pictures to a PC	282
Controlling with a Smartphone	264	Using WEB services	284
Turning on/off the camera using a smartphone	264	When sending images to WEB service	284
Operating the shutter button of the camera using a smartphone (remote recording)	265	When sending images to [Cloud Sync. Service]	287
Playing back or saving images stored on the camera, or uploading them on social media sites	269	About the [LUMIX CLUB]	288
Transferring recorded images to a smartphone automatically	270	About Wi-Fi connections	291
Writing location information of a smartphone on a recorded image	272	Connecting via a wireless access point ([Via Network])	291
Synchronising the camera's clock with a smartphone	273	Connecting directly ([Direct])	294
Combining motion pictures recorded with Snap Movie according to your preference on a smartphone	273	Connecting quickly with the same settings as used previously ([Select a destination from History] / [Select a destination from Favorite])	295
		[Wi-Fi Setup]	297



Connecting with other devices

- **Enjoying 4K motion pictures** 298
 - Viewing 4K motion pictures298
 - Storing 4K motion pictures.....299
- **Viewing on TV screen**..... 300
 - Recording while monitoring camera images302
 - VIERA Link (HDMI) (HDAVI Control™).....303
- **Storing recorded still pictures and motion pictures on your PC** ... 304
 - Downloading software305
 - Copying still pictures and motion pictures307
- **Storing recorded still pictures and motion pictures in the recorder** 309
- **Printing** 310
 - Printing with date and text312

Others

- **Optional accessories**..... 313
 - External Flash (optional).....313
 - AC adaptor (optional) / DC coupler (optional).....314
- **List of monitor/viewfinder displays**..... 315
- **Message displays** 322
- **Q&A**
 - Troubleshooting..... 324
- **Usage cautions and notes** 333





Recording

Recording

Recording mode	47
[Preview]	74
Panorama Shot Mode	76
Bracket recording	141
[Time Lapse Shot]	145
[Stop Motion Animation]	148
[Silent Mode]	201
[Multi Exp.]	204

4K Photo

[4K PHOTO]	120
[Post Focus] recording	132

Focus (AF/MF)

Auto Focus	95
AF Mode	97
Adjusting the AF area position	103
Manual Focus	108
AF/AE Lock	111

Drive

Drive Mode	137
Burst function	138
[Self Timer]	140

Exposure

[Touch AE]	55
[One Push AE]	75
AF/AE Lock	111
Exposure Compensation	112
ISO sensitivity	114
Exposure Bracket	142
[Metering Mode]	196

Picture Quality and Colour Tone

White Balance	116
[Picture Size]	190
[Quality]	190
[Photo Style]	192
[Filter Settings]	194
[Color Space]	196
[Highlight Shadow]	197
[i.Dynamic]	198
[i.Resolution]	198
[Long Shtr NR]	199
[Shading Comp.]	200
[Diffraction Compensation]	200
[HDR]	203

Stabiliser

Dual I.S.	151
5-Axis Hybrid Image Stabiliser	151

Flash

[Flash Mode]	164
2nd curtain synchro	166
[Flash Adjust.]	167
Wireless flash settings	168

Monitoring

Recording while monitoring camera images	302
--	-----



Motion Picture

Motion Picture

Creative Video Mode	89
[4K Live Cropping]	91
[Rec Format]/[Rec Quality]	173
Taking still pictures while a motion picture is being recorded	176
[Snap Movie]	177

Audio

[Sound Rec Level Adj.]	205
[Wind Noise Canceller]	206

Screen settings

[Sound Rec Level Disp.]	205
[Monochrome Live View]	214
[Center Marker]	216
[Zebra Pattern]	217





Setup/Custom

Basic settings

[Format]	34
[Clock Set]	40
Dioptre adjustment	45
Quick Menu	58
[Beep]	225
[Economy]	226
[Reset] (initialisation)	232
[Sensor Cleaning]	233

Customisation

Function buttons	60
Custom Mode	93
[Custom] menu	207



Playback

Playback

Picture playback	180
Motion picture playback	181
Playback Zoom	183
Multi Playback	183
Delete	187
[Auto Review]	214
[Slide Show]	236
[Rotate]/[Rotate Disp.]	248, 250

Edit

[Post Focus]	134
[Focus Stacking]	135
[Title Edit]	239
[RAW Processing]	240
[4K PHOTO Bulk Saving]	242
[Light Composition]	243
[Sequence Composition]	244
[Clear Retouch]	245
[Text Stamp]	246
[Resize]	247
[Cropping]	248

Image settings

[Protect]	238
[Rating]	238



Wi-Fi/Bluetooth

Image App

Image App	256
Remote start-up	264
Remote recording	265
Auto transfer	270

In combination with other devices

Playing back pictures on a TV	275
Printing images	280
Sending images to an AV device	281
Sending images to a PC	282
Sending images to a WEB service	284
Using [Cloud Sync. Service]	287



Connecting with other devices

PC

Transferring images to a PC	304
PHOTOfunSTUDIO	305
SILKYPIX	306

TV

Playing back pictures on a TV screen	300
[VIERA Link]	303

Recorder

Dubbing	309
---------------	-----

Printer

PictBridge	310
------------------	-----



Before use

■ Camera handling

Keep the camera away from excessive vibration, force, or pressure.

- Avoid using the camera under the following conditions, which may damage the lens, monitor, viewfinder, or camera body.

This may also cause the camera to malfunction or prevent recording.

- Dropping or hitting the camera against a hard surface
- Pushing with excessive force on the lens or monitor

The camera is not dust resistant, splash resistant, or waterproof.

Avoid using the camera in places with excessive dust or sand, or where water can come into contact with the camera.

- Avoid using the camera under the following conditions, which present a risk that sand, water, or foreign material may enter the camera through the lens or openings around buttons. Be especially careful because these conditions may damage the camera, and such damage may not be repairable.

- In extremely dusty or sandy places
- In the rain or by the shore, where the camera may be exposed to water

If sand, dust, or liquids such as water droplets adhere to the monitor, wipe them off with a dry soft cloth.

- Not doing so may cause the monitor to respond incorrectly to touch operations.

Do not place your hands inside the mount of the digital camera body. Since the sensor unit is a precision apparatus, it may cause a malfunction or damage.

If you shake the camera while it is turned off, its sensors may move or a rattling sound may be heard. The sound is caused by the In-Body Image Stabiliser, and this is not a malfunction.

■ Condensation (When the lens, the monitor, or viewfinder, is fogged up)

- Condensation may occur when the camera is exposed to sudden changes of temperature or humidity. Avoid these conditions, which may make the lens, monitor, or viewfinder dirty, cause mould, or damage the camera.
- If condensation does occur, turn off the camera and wait about two hours before using it. Once the camera adjusts to the surrounding temperature, the fogging will clear naturally.

■ Always take a test shot first

Before important events when you will use the camera (at weddings, for example), always take a test shot to make sure that pictures and sound record correctly.

■ No compensation for missed shots

We cannot compensate for missed shots if technical problems with the camera or card prevent recording.

■ Carefully observe copyright laws

Unauthorised use of recordings that contain works with copyright for purposes other than personal use is prohibited under copyright law. Recording of certain material may be restricted even for the purpose of personal use.

■ Also refer to “Usage cautions and notes” (→333)**■ Before using the camera, make sure all accessories specified in the attached “Basic Operating Instructions” are supplied.**

For details on the optional accessories, refer to (→313) or “Basic Operating Instructions”.

Standard Accessories

Check that all the accessories are supplied before using the camera.

- The accessories and their shape will differ depending on the country or area where the camera was purchased.

For details on the accessories, refer to “Basic Operating Instructions”.

- Battery Pack is indicated as battery pack or battery in the text.
- SD Memory Card, SDHC Memory Card and SDXC Memory Card are indicated as card in the text.
- **Cards are optional.**
- Please dispose of all packaging appropriately.
- Keep small parts in a safe place out of the reach of children.

■ Optional accessories (→313)



Names and Functions of Main Parts

■ Camera body

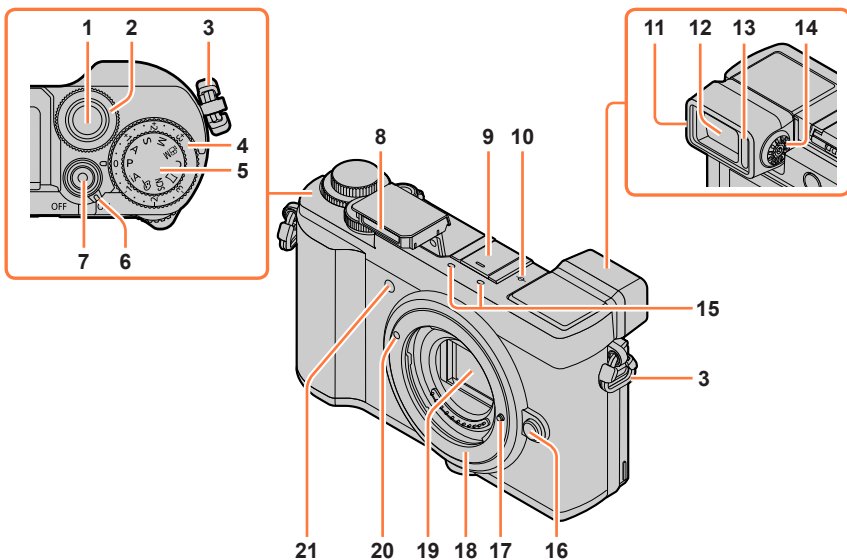

- | | | | |
|----|---|----|---|
| 1 | Shutter button (→46) | 13 | Eye sensor (→45) |
| 2 | Front dial (→47) | 14 | Dioptre adjustment dial (→45) |
| 3 | Shoulder strap eyelet (→21) | 15 | Stereo microphone (→42, 206)
Be careful not to cover the microphone with your finger. Doing so may make sound difficult to record. |
| 4 | Exposure compensation dial (→112) | 16 | Lens release button (→36) |
| 5 | Mode dial (→47) | 17 | Lens lock pin |
| 6 | Camera [ON/OFF] switch (→40) | 18 | Mount |
| 7 | Motion picture button (→46, 171) | 19 | Sensor |
| 8 | Flash (→42, 161) | 20 | Lens fitting mark (→36) |
| 9 | Hot shoe (Hot shoe cover) (→313)
Keep the hot shoe cover out of reach of children to prevent swallowing. | 21 | Self-timer indicator (→140) /
AF Assist Lamp (→42, 209) |
| 10 | Focus distance reference mark (→110) | | |
| 11 | Eyecup (→334) | | |
| 12 | Viewfinder (→45, 315) | | |



Names and Functions of Main Parts

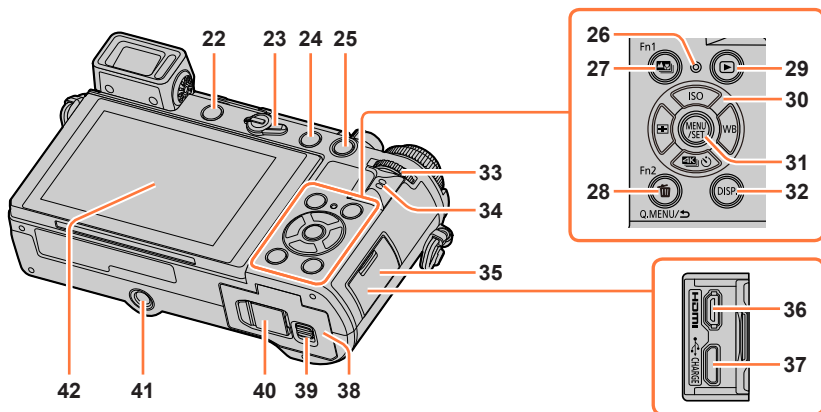

- 22 [LVF] button (→45) / [Fn3] button (→60)
- 23 Focus mode lever (→96, 108)
- 24 [⚡] (Flash open) button (→161)
- 25 [AF/AE LOCK] button (→111)
- 26 Charging lamp (→25) / WIRELESS connection lamp (→253)
- 27 [⏪] ([Post Focus]) button (→132) / [Fn1] button (→60)
- 28 [⏴] (Delete) button (→187) / [Q.MENU/⏴] (Cancel) button (→58) / [Fn2] button (→60)
- 29 [▶] (Playback) button (→180)
- 30 Cursor button (→50)
[ISO] (ISO sensitivity) (▲) (→114)
[WB] (White balance) (▶) (→116)
[⏸] (Drive Mode) (▼) (→137)
[AF] (AF Mode) (◀) (→97)
- 31 [MENU/SET] button (→50, 56)
- 32 [DISP.] button (→50)
- 33 Rear dial (→47)
- 34 Speaker (→42, 225)

- 35 Socket cover (→24)
- 36 [HDMI] socket (→300)
- 37 [USB/CHARGE] socket (→24, 307, 310)
- 38 Card/Battery door (→23, 32)
- 39 Release lever (→23, 32)
- 40 DC coupler cover (→314)
When using an AC adaptor, ensure that the Panasonic DC coupler (optional) and AC adaptor (optional) are used.
- 41 Tripod mount (→338)
Do not attach this unit to tripods that have screws with a length of 5.5 mm (0.22 inch) or more. Doing so may damage this unit or the unit may not be secured properly on the tripod.
- 42 Touch screen (→53) / monitor (→315)

Function buttons [Fn4] to [Fn8] are touch icons.

They can be displayed by touching the [Fn] tab on the recording screen.

Names and Functions of Main Parts

■ Lens

H-FS12032

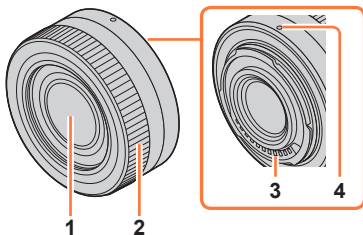

H-FS35100

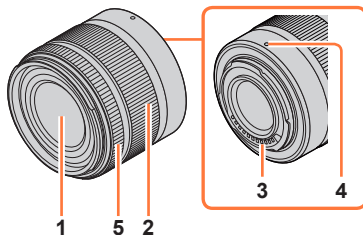

H-FS12060

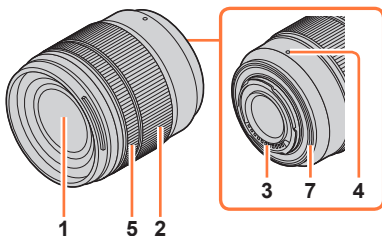

H-FS1442A

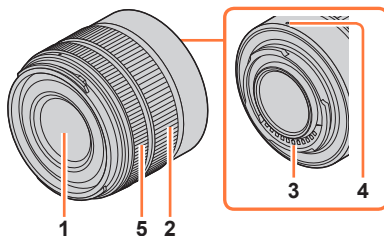

H-H020A

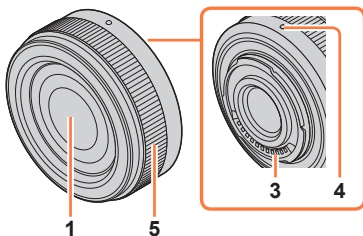

H-FS14140

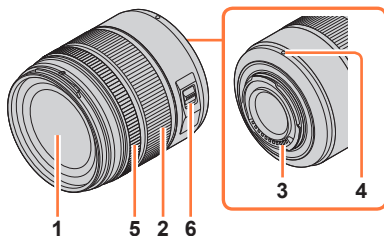

- 1 Lens surface
- 2 Zoom ring (→155)
- 3 Contact point
- 4 Lens fitting mark (→36)

- 5 Focus ring (→108)
- 6 [O.I.S.] switch (→152)
- 7 Lens mount rubber (→336)



Names and Functions of Main Parts

- The interchangeable lens (H-FS12032) does not have a focus ring, but you can use manual focus by operating the camera. (→108)
- The interchangeable lens (H-H020A) utilises a lens drive system to realize a compact and bright F1.7 lens. As a result, sound and vibration may occur during focus operation, but this is not a malfunction.
- Operating sounds will be recorded when auto focus is performed during motion picture recording. It is recommended to record with [Continuous AF] (→175) is set to [OFF], if the sound of operation bothers you. (→171)
Also, it is not possible to set the Focus Mode to [AFC] or [AFF]. (→96)



About the Lens

This unit can use the dedicated lenses compatible with the Micro Four Thirds™ System lens mount specification (Micro Four Thirds mount).

You can also use a lens of any of the following standards by attaching a mount adaptor.



Lens	Mount adaptor
Four Thirds™ mount specification lens 	Mount Adaptor (DMW-MA1: optional)
Leica M Mount interchangeable lens	M Mount Adaptor (DMW-MA2M: optional)
Leica R Mount interchangeable lens	R Mount Adaptor (DMW-MA3R: optional)

About the lens and functions

Depending on the lens used, certain functions, such as Auto Focus, Image Stabiliser, and zoom functions, may be disabled or operate differently.

For details on the lens used, refer to the website.

Refer to catalogues/Web pages for most current information regarding compatible lenses.

<http://panasonic.jp/support/global/cs/dsc/>

(This Site is English only.)

- The focal length noted on the Micro Four Thirds lens is equivalent to double when converted to the 35 mm film camera. (It will be equivalent to 100 mm lens when a 50 mm lens is used.)

About the firmware of your interchangeable lens

For smoother recording, we recommend updating the firmware of the interchangeable lens to the latest version.

- **To view the latest information on the firmware or to download the firmware, visit the support site below:**

<http://panasonic.jp/support/global/cs/dsc/>

(This Site is English only.)

- To check the firmware version of the interchangeable lens, attach it to the camera body and select [Version Disp.] in the [Setup] menu.



Attaching the Shoulder Strap

We recommend attaching the shoulder strap when using the camera to prevent it from dropping.

1 Pass the shoulder strap through the hole at the shoulder strap eyelet

Ⓐ Shoulder strap eyelet

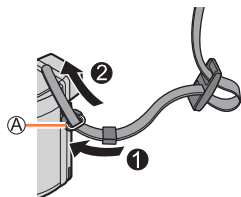

2 Pass the end of the shoulder strap through the stopper

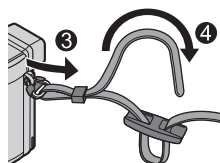

3 Pass the end of the shoulder strap through the hole on the other side of the stopper

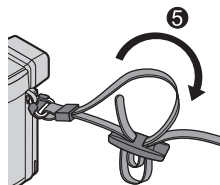

4 Pull the shoulder strap and then check that it will not come out

- Perform steps **1** to **4** and then attach the other side of the shoulder strap.
- Use the shoulder strap around your shoulder.
 - Do not wrap the strap around your neck. It may result in injury or accident.
- Do not leave the shoulder strap where an infant can reach it.
 - It may result in an accident by mistakenly wrapping around the neck.

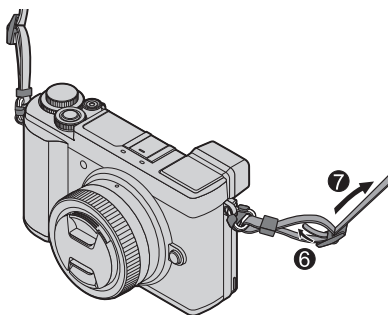

Charging battery

Always use the dedicated AC adaptor (supplied), USB connection cable (supplied), and battery for this camera.

- **Always charge before first use! (battery shipped uncharged)**
- **Charge the battery while it is in the camera.**

Camera status	Charge
Turn off	Yes
Turn on	No

About batteries that you can use with this unit

It has been found that counterfeit battery packs which look very similar to the genuine products are made available to purchase in some markets. Some of these battery packs are not adequately protected with internal protection to meet the requirements of appropriate safety standards. There is a possibility that these battery packs may lead to fire or explosion. Please be advised that we are not liable for any accident or failure occurring as a result of use of a counterfeit battery pack. To ensure that safe products are used we recommend that a genuine Panasonic battery pack is used.



Inserting the battery

To charge the battery, insert it into the camera.

1 Slide the release lever to the [OPEN] position and open the card/battery door

(A) Release lever

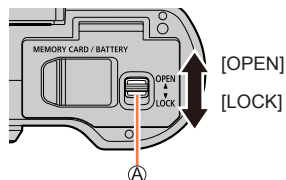

2 Insert the battery all the way

- Insert the battery all the way firmly and check that it is locked by lever.

3 Close the card/battery door and then slide the release lever to the [LOCK] position

(B) Make sure to insert the battery in the correct orientation (△).

(C) Lever

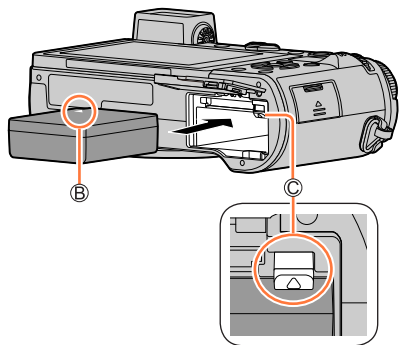

To remove battery

Move the lever in the card/battery compartment in the direction of the arrow.

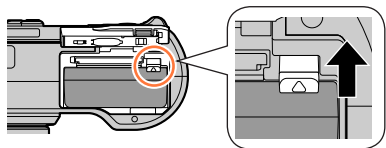

- Always use genuine Panasonic batteries.
- If you use other batteries, we cannot guarantee the quality of this product.
- If you close the card/battery door with the battery not inserted all the way, the battery may pop out.
- To remove the battery, turn the camera off and wait until the LUMIX indicator on the screen goes off. (Failure to wait may cause the camera to malfunction and may damage the card or recorded data.)
- Remove battery from camera after use.



Charging the battery

We recommend charging in a location where the ambient temperature is between 10 °C and 30 °C (50 °F to 86 °F) (same for the battery temperature).

Insert the battery into the camera.
Make sure that the camera is turned off.

The battery can be charged from an outlet or through a PC.

Ⓐ USB connection cable (supplied)

Ⓑ AC adaptor (supplied)

Ⓒ To the electrical outlet

Ⓓ Computer

Getting ready: Turn on the computer.

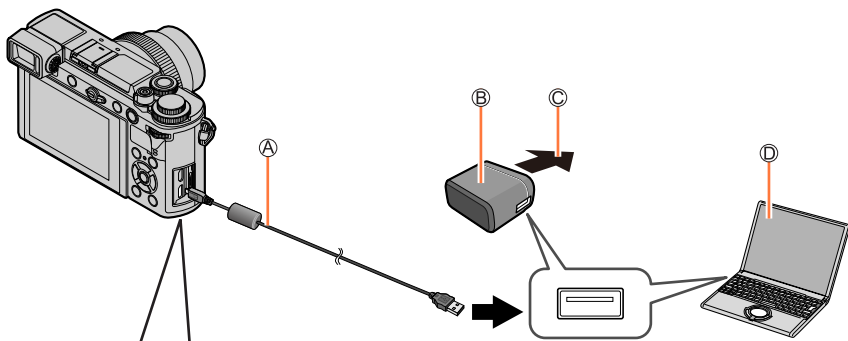

■ To open the socket cover

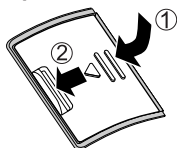

- ① Press lightly
- ② Keep pressing and slide

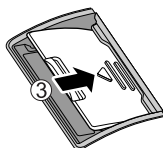

- ③ Remove your finger
- The socket cover will be stored inside the camera.

To close the cover

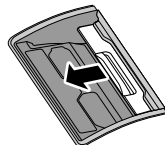

- When the cover is completely closed, it snaps into place.

Charging battery

■ Connect the USB connection cable (supplied) to the [USB/CHARGE] socket

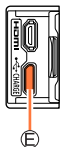

Ⓔ [USB/CHARGE] socket

- This terminal is located at the bottom when the camera is in an upright position.
- Always check the direction of the socket, and hold the plug straight to insert or remove it. (If the cable is inserted in the wrong direction, the socket could become deformed and cause faulty operation.) Also, do not insert into the wrong socket. Doing so may cause damage to this unit.

- If the computer enters sleep mode during charging, charging may be stopped.
- If a notebook computer that is not connected to an electrical outlet is connected to the camera, the battery of the notebook computer will be depleted. Do not leave the camera and notebook connected for a long period of time.
- Always connect the USB connection cable to the USB connector on your computer. Do not connect the USB connection cable to the USB connector of the monitor, keyboard, printer, or USB hub.

Charging lamp indications

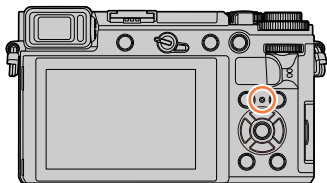
**Charging lamp (Red)**

On: Charging in progress

Off: Charging complete

(After charging stops, disconnect the camera from the electrical outlet or your computer.)

Flashing: Charging error

(For instructions on correcting the problem, refer to (→324).)



Charging battery

Notes on charging time

When using the AC adaptor (supplied)

Charging time	Approx. 190 min.
----------------------	------------------

- The charging time indicated above is the time required for charging in case when the battery is completely used up. The time required for charging differs depending on conditions of battery usage. Charging takes longer in cases when temperatures are either high or low and when the battery has not been used for a long period of time.
 - The time required for charging through the computer varies depending on the power supply capacity of the computer.
- Do not use any other USB connection cables except the supplied one. Doing so may cause malfunction of the camera.
 - Do not use any other AC adaptors except the supplied one.
 - Do not use a USB extension cable.
 - The AC adaptor (supplied) and the USB connection cable (supplied) are dedicated accessories of this camera. Do not use them for other devices.
 - Remove the battery after use. (The battery will be exhausted if left for a long period of time after being charged.)
 - If there is any trouble related to the electrical outlet (i.e. power failure), charging may not complete properly. Disconnect the USB connection cable (supplied) and reconnect it to the camera.

Remaining battery



	75% or higher
	74% to 50%
	49% to 25%
	24% or below
	Low battery • Recharge the battery or replace it with a fully charged battery.

- The battery level indicated on the screen is approximate. The exact level varies depending on the environment and the operating conditions.

Estimated number of recordable pictures and operating time

Numbers of recordable still pictures are based on CIPA (Camera & Imaging Products Association) standards.

When a Panasonic SDHC memory card and the supplied battery are used.

■ Recording still pictures (When using monitor)

When the interchangeable lens (H-FS12032) is used	
Number of recordable pictures	Approx. 260 pictures
Recording time	Approx. 130 min.
When the interchangeable lens (H-FS35100) is used	
Number of recordable pictures	Approx. 260 pictures
Recording time	Approx. 130 min.
When the interchangeable lens (H-FS12060) is used	
Number of recordable pictures	Approx. 260 pictures
Recording time	Approx. 130 min.
When the interchangeable lens (H-FS1442A) is used	
Number of recordable pictures	Approx. 260 pictures
Recording time	Approx. 130 min.
When the interchangeable lens (H-H020A) is used	
Number of recordable pictures	Approx. 260 pictures
Recording time	Approx. 130 min.
When the interchangeable lens (H-FS14140) is used	
Number of recordable pictures	Approx. 250 pictures
Recording time	Approx. 120 min.



■ Recording still pictures (When using viewfinder (LVF))

The values in parentheses apply when [Time] in [Power Save LVF Shooting] is set to [1SEC] and [Power Save LVF Shooting] is activated. (Using Panasonic measurement conditions based on CIPA standards)

When the interchangeable lens (H-FS12032) is used	
Number of recordable pictures	Approx. 250 pictures (Approx. 900 pictures)
Recording time	Approx. 120 min.
When the interchangeable lens (H-FS35100) is used	
Number of recordable pictures	Approx. 250 pictures (Approx. 900 pictures)
Recording time	Approx. 120 min.
When the interchangeable lens (H-FS12060) is used	
Number of recordable pictures	Approx. 250 pictures (Approx. 900 pictures)
Recording time	Approx. 120 min.
When the interchangeable lens (H-FS1442A) is used	
Number of recordable pictures	Approx. 250 pictures (Approx. 900 pictures)
Recording time	Approx. 120 min.
When the interchangeable lens (H-H020A) is used	
Number of recordable pictures	Approx. 240 pictures (Approx. 860 pictures)
Recording time	Approx. 120 min.
When the interchangeable lens (H-FS14140) is used	
Number of recordable pictures	Approx. 240 pictures (Approx. 820 pictures)
Recording time	Approx. 120 min.

■ Recording motion pictures (When using monitor)

[AVCHD] (Recording with picture quality set to [FHD/17M/50i])

When the interchangeable lens (H-FS12032) is used	
Available recording time	Approx. 90 min.
Actual available recording time*	Approx. 45 min.
When the interchangeable lens (H-FS35100) is used	
Available recording time	Approx. 90 min.
Actual available recording time*	Approx. 45 min.
When the interchangeable lens (H-FS12060) is used	
Available recording time	Approx. 90 min.
Actual available recording time*	Approx. 45 min.
When the interchangeable lens (H-FS1442A) is used	
Available recording time	Approx. 90 min.
Actual available recording time*	Approx. 45 min.
When the interchangeable lens (H-H020A) is used	
Available recording time	Approx. 90 min.
Actual available recording time*	Approx. 45 min.
When the interchangeable lens (H-FS14140) is used	
Available recording time	Approx. 90 min.
Actual available recording time*	Approx. 45 min.

[MP4] (Recording with picture quality set to [FHD/28M/60p] or [FHD/28M/50p])

When the interchangeable lens (H-FS12032) is used	
Available recording time	Approx. 90 min.
Actual available recording time*	Approx. 45 min.
When the interchangeable lens (H-FS35100) is used	
Available recording time	Approx. 90 min.
Actual available recording time*	Approx. 45 min.
When the interchangeable lens (H-FS12060) is used	
Available recording time	Approx. 90 min.
Actual available recording time*	Approx. 45 min.
When the interchangeable lens (H-FS1442A) is used	
Available recording time	Approx. 90 min.
Actual available recording time*	Approx. 45 min.
When the interchangeable lens (H-H020A) is used	
Available recording time	Approx. 90 min.
Actual available recording time*	Approx. 45 min.
When the interchangeable lens (H-FS14140) is used	
Available recording time	Approx. 90 min.
Actual available recording time*	Approx. 45 min.



Charging battery

[MP4] (Recording with picture quality set to [4K/100M/30p] or [4K/100M/25p])

When the interchangeable lens (H-FS12032) is used	
Available recording time	Approx. 70 min.
Actual available recording time*	Approx. 35 min.
When the interchangeable lens (H-FS35100) is used	
Available recording time	Approx. 80 min.
Actual available recording time*	Approx. 40 min.
When the interchangeable lens (H-FS12060) is used	
Available recording time	Approx. 70 min.
Actual available recording time*	Approx. 35 min.
When the interchangeable lens (H-FS1442A) is used	
Available recording time	Approx. 70 min.
Actual available recording time*	Approx. 35 min.
When the interchangeable lens (H-H020A) is used	
Available recording time	Approx. 80 min.
Actual available recording time*	Approx. 40 min.
When the interchangeable lens (H-FS14140) is used	
Available recording time	Approx. 70 min.
Actual available recording time*	Approx. 35 min.

* The time you can actually record when repeating actions such as turning the camera on/off and starting/stopping recording.

■ Viewing pictures (When using monitor)

When the interchangeable lens (H-FS12032) is used	
Playback time	Approx. 210 min.
When the interchangeable lens (H-FS35100) is used	
Playback time	Approx. 210 min.
When the interchangeable lens (H-FS12060) is used	
Playback time	Approx. 200 min.
When the interchangeable lens (H-FS1442A) is used	
Playback time	Approx. 210 min.
When the interchangeable lens (H-H020A) is used	
Playback time	Approx. 200 min.
When the interchangeable lens (H-FS14140) is used	
Playback time	Approx. 210 min.



Charging battery

- **The operating times and number of recordable pictures will differ according to the environment and the operating conditions.**

For example, in the following cases, the operating times shorten and the number of recordable pictures is reduced.

- In low-temperature environments, such as on ski slopes.
 - When the flash is used repeatedly.
- If available battery power is significantly reduced, battery is reaching end of lifespan. Please purchase a new battery.



Inserting and removing the card (optional)

- Make sure that the camera is turned off.

1 Slide the release lever to the [OPEN] position and open the card/battery door

(A) Release lever

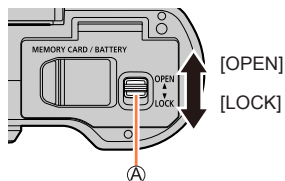

2 Insert the card all the way

(B) Do not touch the terminal

- Check the orientation of a card.
- Insert the card all the way firmly until it clicks.

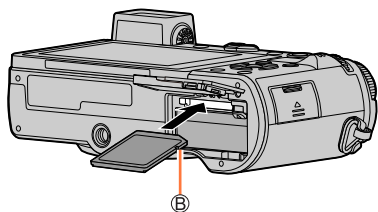

3 Close the card/battery door and slide the release lever to the [LOCK] position

■ To remove card

Press the centre of the card.

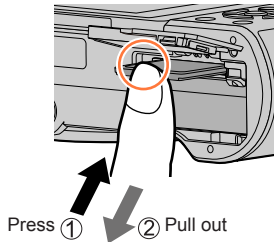

- Keep the memory card out of reach of children to prevent swallowing.
- To remove the card, turn the camera off and wait until the LUMIX indicator on the screen goes off. (Failure to wait may cause the camera to malfunction and may damage the card or recorded data.)



About the Card

The following SD standard-based cards can be used.

Type of Card	Capacity	Notes
SD Memory Cards	512 MB – 2 GB	<ul style="list-style-type: none"> This unit is compatible with UHS-I UHS Speed Class 3 standard SDHC/SDXC memory cards. Operation of the cards listed on the left has been confirmed with Panasonic brand card.
SDHC Memory Cards	4 GB – 32 GB	
SDXC Memory Cards	48 GB – 128 GB	

■ About motion picture/4K photo recording and speed class ratings

Use a card that meets the following ratings of the SD Speed Class or UHS Speed Class.

- SD Speed Class and UHS Speed Class are the speed standards regarding continuous writing. Confirm the SD speed by checking the card label or other card related materials.

[Rec Format]	[Rec Quality]	Speed class	Label example
[AVCHD]	All	Class 4 or higher	CLASS 4 4
[MP4]	[FHD]/[HD]		
[MP4]	[4K]	UHS Speed Class 3	U3
When recording in 4K Photo / [Post Focus]		UHS Speed Class 3	U3

- Latest information:
<http://panasonic.jp/support/global/cs/dsc/>
 (This site is available in English only.)

Access to the card

The access indication displays red when pictures are being recorded on the card.



- While the camera is accessing the card (for an operation such as picture writing, reading, deletion, or formatting), do not turn off the camera or remove the battery, card, AC adaptor (optional) or DC coupler (optional). Do not subject the camera to vibrations, impact, or static electricity. The card or the data on the card may be damaged, and this unit may no longer operate normally. If operation fails due to vibration, impact or static electricity, perform the operation again.
- If you set the write-protect switch to "LOCK", you may not be able to write, delete or format the data or display it by recording date.
- It is recommended that you copy important pictures to your computer (as electromagnetic waves, static electricity, or faults may cause data to be damaged).



Formatting the card (initialisation)

Format the card before recording a picture with this unit.

Since data cannot be recovered after formatting, make sure to back up necessary data in advance.

MENU →  **[Setup]** → **[Format]**

- This requires a sufficiently charged battery, or an AC adaptor (optional) and DC coupler (optional).
- Do not turn off the camera or perform other operations during formatting.
- Always format cards with this camera. Please reformat the card if it has already been formatted with a computer or another device.

Estimated recording capacity (number of pictures/recording time)

The number of pictures you can take and the recording time vary in proportion to card capacity (and depending on recording conditions and type of card).

Recording picture capacity (still pictures)

When **[Aspect Ratio]** is set to **[4:3]** and **[Quality]** is set to **[**

[Picture Size]	16 GB	32 GB	64 GB	128 GB
L (20M)	1450	2910	5810	11510
M (10M)	2630	5280	10510	20810
S (5M)	4600	9220	17640	34940

When **[Aspect Ratio]** is set to **[4:3]** and **[Quality]** is set to **[RAW **

[Picture Size]	16 GB	32 GB	64 GB	128 GB
L (20M)	450	900	1810	3590
M (10M)	520	1050	2110	4180
S (5M)	570	1150	2290	4550

- When the number of recordable pictures exceeds 9,999, "9999+" is displayed.

Recording time capacity (motion pictures)

- The recordable time is the total time of all the motion pictures which have been recorded.

([h], [m] and [s] indicate “hour”, “minute” and “second”.)

When [Rec Format] is [AVCHD]

[Rec Quality]	16 GB	32 GB	64 GB	128 GB
[FHD/28M/50p]	1h10m	2h30m	5h00m	9h55m
[FHD/17M/50i]	2h00m	4h05m	8h15m	16h25m
[FHD/24M/25p] [FHD/24M/24p]	1h25m	2h55m	5h50m	11h35m

When [Rec Format] is [MP4]

[Rec Quality]	16 GB	32 GB	64 GB	128 GB
[4K/100M/30p] [4K/100M/25p] [4K/100M/24p]	20m00s	41m00s	1h25m	2h45m
[FHD/28M/60p] [FHD/28M/50p]	1h10m	2h25m	5h00m	9h55m
[FHD/20M/30p] [FHD/20M/25p]	1h35m	3h15m	6h40m	13h15m
[HD/10M/30p] [HD/10M/25p]	3h05m	6h20m	12h45m	25h20m

- [AVCHD] motion pictures:
Files are split into smaller motion picture files for recording when the file size exceeds 4 GB.
- MP4 motion pictures with a [Rec Quality] size of [FHD] or [HD]:
You can continue recording without interruption even if the continuous recording time exceeds 30 minutes or the file size exceeds 4 GB, but the motion picture file will be divided and recorded/played back separately.
- MP4 motion pictures with a [Rec Quality] size of [4K]:
Motion picture file will be recorded and played back in separate files in the following cases.
(You can continue recording without interruption.)
 - When using an SDHC memory card: If the file size exceeds 4 GB
 - When using an SDXC memory card: If the continuous recording time exceeds 3 hours and 4 minutes or if the file size exceeds 96 GB
- **The maximum available continuous recording time is displayed on the screen.**

Attaching/Removing the Lens

- Check that the camera is turned off.
- When attaching or detaching the interchangeable lens (H-FS12032/H-FS35100), retract the lens barrel.
- Change lenses where there is not a lot of dirt or dust. Refer to (→334) when dirt or dust gets on the lens.

■ Attaching the lens

- When a lens rear cap is attached to the lens, detach it.
 - When a body cap is attached to the camera, detach it.
- ① Align the lens fitting marks (A) and then rotate the lens in the direction of the arrow until it clicks

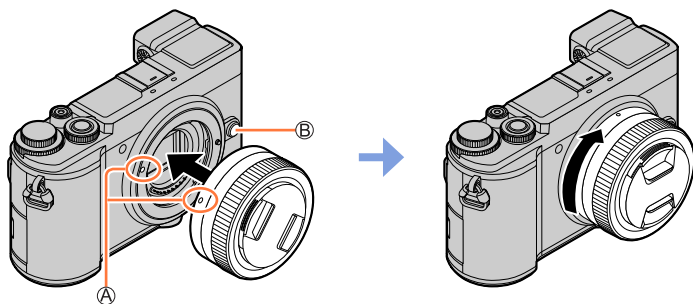

- **Do not press the lens release button (B) when you attach a lens.**
- Do not try to attach the lens when holding it at an angle to the camera body as the lens mount may get scratched.

Attaching/Removing the Lens

■ Detaching the lens

- Attach the lens cap.
- ① While pressing on the lens release button (A), rotate the lens toward the arrow until it stops and then remove.
- Hold the part around the base of the lens to rotate it.

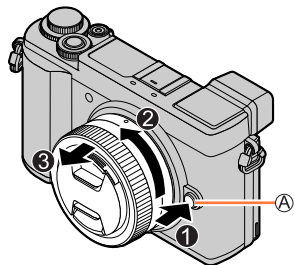

- When the lens is removed from the camera, dust and other particles may accumulate on or enter the camera or lens. Be sure to attach the body cap and the lens rear cap.

Attaching/Removing the Lens

Attaching the Lens Hood

When recording into strong backlight, irregular reflection may occur within the lens. The lens hood reduces the inclusion of unwanted light in the recorded images and lowers the drop in contrast. The lens hood cuts off excess lighting and improves the picture quality.

- The interchangeable lens (H-FS12032/H-H020A) does not have a lens hood.

To attach the lens hood (flower shape) that came with the interchangeable lenses (H-FS35100/H-FS12060/H-FS1442A/H-FS14140)

Hold the lens hood by placing your fingers as shown in the figure.

- Do not hold the lens hood in such a way that it will be bent.



- 1** Align the mark (A) (●) on the lens hood with the mark on the tip of the lens

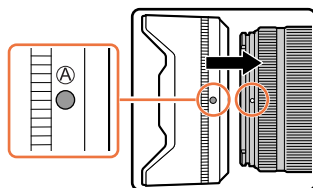

- 2** Rotate the lens hood in the direction of the arrow until it clicks and then align the mark (B) (◻) on the lens hood with the mark on the tip of the lens

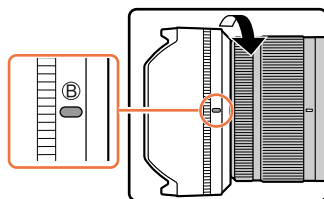

Attaching/Removing the Lens

 **Temporarily Storing the Lens Hood**
When using the interchangeable lens (H-FS35100/H-FS12060)

- ① Turn the lens hood in the direction of the arrow to detach it
- ② Align the mark (C) (◻) on the lens hood with the mark on the tip of the lens
- ③ Turn the lens hood in the direction of the arrow until it clicks into place

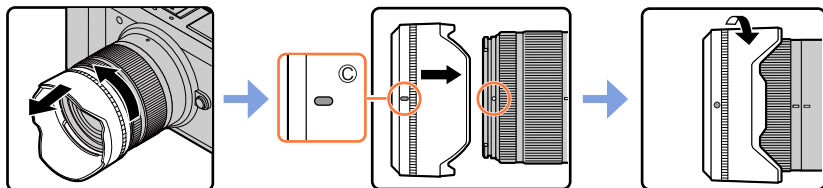
**When using the interchangeable lens (H-FS1442A/H-FS14140)**

- ① Turn the lens hood in the direction of the arrow to detach it
- ② Align the mark (D) (●) on the lens hood with the mark on the tip of the lens
- ③ Turn the lens hood in the direction of the arrow until it clicks into place

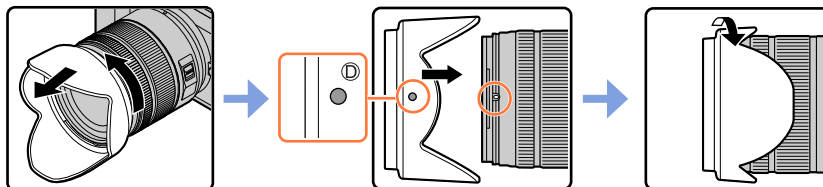

Setting the clock

The clock is not set when the camera is shipped.

- 1 Set the Camera [ON/OFF] switch to [ON]**
 - If the language select screen is not displayed, proceed to step 4.

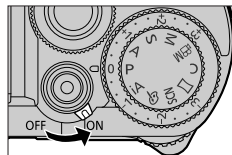

- 2 Press [MENU/SET] while the message is displayed**
- 3 Press ▲ ▼ to select the language, and press [MENU/SET]**
 - The [Please set the clock] message appears.
- 4 Press [MENU/SET]**
- 5 Press ◀ ▶ to select the items (year, month, day, hour, minute), and press ▲ ▼ to set**

- Ⓐ : Home time
- : Destination time
- Ⓑ Style
- Ⓒ Display order
- Ⓓ Time display format

■ To set the display order or time display format

Select [Style] and press [MENU/SET] to display the setting screen for display order and time display format.



- 6 Press [MENU/SET]**

- 7 When [The clock setting has been completed.] is displayed, press [MENU/SET]
- 8 When [Please set the home area] is displayed, press [MENU/SET]
- 9 Press ◀▶ to set your home area and press [MENU/SET]

- Ⓔ City or area name
- Ⓕ Current time
- Ⓖ Difference from GMT (Greenwich Mean Time)

- When an interchangeable lens (H-FS12032/ H-FS35100) is used and the lens barrel is retracted, recording is not possible (a message will be displayed). Rotate the zoom ring to extend the lens. (→43)



■ Changing time settings

Perform steps 5 and 6 by selecting [Setup] menu → [Clock Set].

- For details about how to set the menu (→56)

Holding the camera

Hold the camera gently with both hands keeping your arms close to your body while standing with your feet slightly apart.

- Do not block the flash, AF Assist Lamp, microphone, or speaker with your fingers or other objects.
- Make sure that the camera does not move at the moment the shutter button is pressed.
- Make sure your footing is stable and there is no danger of colliding with another person or object in the vicinity while taking pictures.

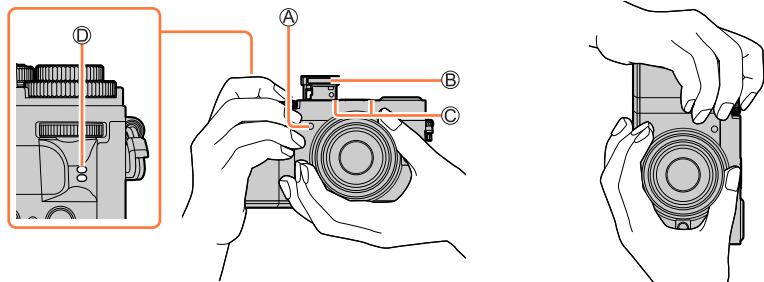

- Ⓐ AF Assist Lamp
- Ⓑ Flash
- Ⓒ Microphone
- Ⓓ Speaker

■ About the direction detect function

Still pictures recorded with the camera held vertically can be automatically displayed in portrait orientation during playback. (Only when [Rotate Disp.] is set to [ON].)

- The direction detect function may not operate correctly if pictures are taken with the camera pointing up or down.
- Motion pictures, 4K burst files recorded with the 4K Photo function, and pictures recorded in [Post Focus] cannot be displayed vertically.



Extending/retracting the lens [when the interchangeable lens (H-FS12032/H-FS35100) is attached]

■ How to Extend the Lens

Rotate the zoom ring in the direction of arrow ① from position (A) (the lens is retracted) to position (B) [12 mm to 32 mm (H-FS12032), 35 mm to 100 mm (H-FS35100)] to extend the lens.

- When the lens barrel is retracted, images cannot be recorded.

© The lens is retracted

■ How to Retract the Lens

Rotate the zoom ring in the direction of arrow ② from position (B) [12 mm to 32 mm (H-FS12032), 35 mm to 100 mm (H-FS35100)] to position (A) to retract the lens.

- The zoom ring will seem to click into the 12 mm position (H-FS12032) or 35 mm position (H-FS35100), but continue to rotate the lens until it reaches position (A).
- When you are not recording images, we recommend that you retract the lens.

Ⓓ The lens is extended

Example: H-FS12032

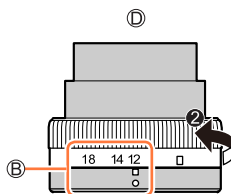
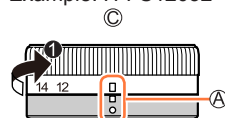

Adjusting the angle of the monitor and viewfinder

The monitor and viewfinder can be rotated to suit your needs. This is convenient as it allows you to take pictures from various angles by adjusting the monitor and viewfinder.

■ Adjusting the angle of the monitor

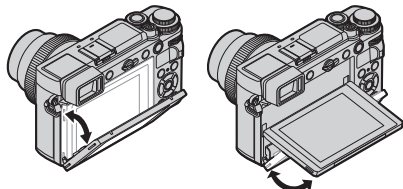

■ Adjusting the angle of the viewfinder

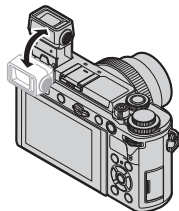

Free angle shooting

Taking pictures at high angle

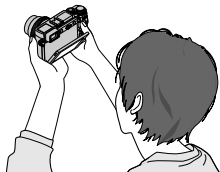

Taking pictures at low angle



- Be careful not to catch your finger, etc. in the monitor or viewfinder.
- When adjusting the angle of the monitor and viewfinder, be careful not to apply too much force. Doing so may cause damage or malfunction.
- When not using this camera, close the monitor and viewfinder completely back to the original position.
- Before attaching a tripod or unipod, close the monitor back to the original position.
- Depending on the tripod or unipod being used, the maximum angle to which the monitor can be adjusted will be limited.
- Use of an external flash (optional) will limit the maximum angle to which the viewfinder can be adjusted.



Buttons/Dials Used for Recording

[LVF] button (Recording pictures using the viewfinder)

1 Press [LVF] button

- Ⓐ Eye Sensor
- Ⓑ [LVF] button

You can switch between monitor display and Viewfinder display.

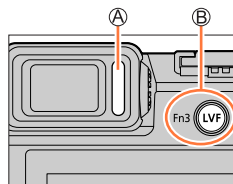

Automatic switching
between viewfinder and
monitor*

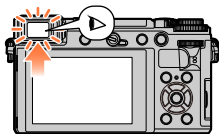

Viewfinder display*

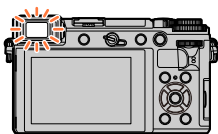

Monitor display

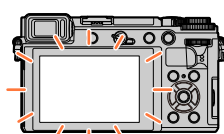

* When [Eye Sensor AF] in the [Custom] ([Focus / Release Shutter]) menu is set to [ON], the camera adjusts the focus automatically as the eye sensor is activated. Even when [Eye Sensor AF] is set and the camera automatically adjusts the focus, a beep will not sound.

■ Automatic switching between viewfinder and monitor

The eye sensor automatically switches the display to viewfinder when your eye or an object moves close to the viewfinder. When the eye or object moves away from the viewfinder, the camera returns to monitor display.

- Battery drainage can be suppressed by setting [Power Save LVF Shooting] in [Economy] (→226).
- The eye sensor does not work depending on the angle of the monitor.

■ About dioptre adjustment

- ① Open the viewfinder
- ② Rotate the dioptre adjustment dial
 - Rotate it to adjust until you are able to clearly see the characters displayed in the viewfinder.

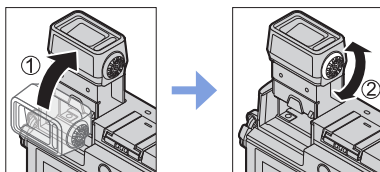

- The eye sensor may react depending on the shape of your eyeglasses, the way you hold the camera, or whether the eye sensor is exposed to strong light.
- During motion picture playback or Slide Show, the eye sensor does not operate.

Shutter button (Taking pictures)

1 Press the shutter button halfway (press lightly) to focus on the subject

- Ⓐ Focus display
(When focus is aligned: illuminated
When focus is not aligned: flashing)
- Ⓑ Aperture value
- Ⓒ Shutter speed

- The aperture value and shutter speed are displayed. (If the aperture value and shutter speed are shown in red and flashing, you do not have the appropriate exposure, unless you are using the flash.)

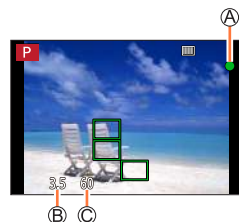

2 Press the shutter button fully (push the button all the way), and take the picture



- Pictures can be taken only when the image is correctly focused as long as the [Focus/Release Priority] is set to [FOCUS].
- Even during menu operation or picture playback, if you press the shutter button halfway, you can instantly set the camera ready for recording.

Motion picture button (Recording motion pictures)

1 Press the motion picture button to start recording

- Immediately release the motion picture button after pressing it.

2 Press the motion picture button again to end recording

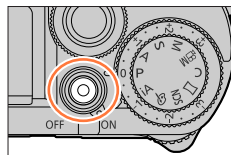

Mode dial (Select the recording mode)

1 Set to the desired recording mode

- Rotate the mode dial slowly to select the desired mode.

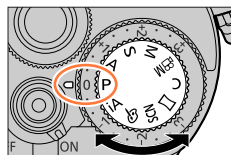

iA	Intelligent Auto Mode (→64)
	Intelligent Auto Plus Mode (→64)
P	Programme AE Mode (→69)
A	Aperture-Priority AE Mode (→70)
S	Shutter-Priority AE Mode (→71)
M	Manual Exposure Mode (→72)
M	Creative Video Mode (→89)
C	Custom Mode (→93)
	Panorama Shot Mode (→76)
SCN	Scene Guide Mode (→79)
	Creative Control Mode (→83)

Front Dial/Rear Dial

Front Dial

Rotating:

Selection of items or setting of values is performed during the various settings.

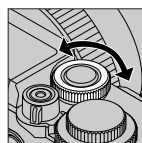

Rear Dial

Rotating:

Selection of items or setting of values is performed during the various settings.

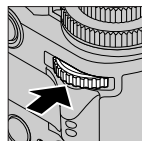
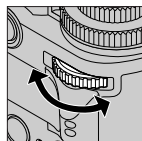

Pressing:

Operations that are the same as [MENU/SET] button, such as determine settings, etc., are performed during the various settings.

Buttons/Dials Used for Recording

Allows you to set the aperture, shutter speed, and other settings when in [P] / [A] / [S] / [M] modes.

Mode dial	Front dial	Rear Dial
P	Programme Shift	Programme Shift*
A	Aperture value	Aperture value*
S	Shutter speed	Shutter speed*
M	Aperture value	Shutter speed*

* Pressing the rear dial enables you to set the exposure compensation when [Exposure Dial] is set to [OFF] in [Dial Set.] in the [Custom] ([Operation]) menu. In Manual Exposure Mode, you can correct the exposure only when the ISO sensitivity is set to [AUTO].



Temporarily changing the operation of the front/rear dials ([Dial Operation Switch])

Preparations

- Assign [Dial Operation Switch] to the function button (→60)

1 Press the function button

- A guide will be displayed showing the items temporarily assigned to the front/rear dials.
- If no operations are performed, the guide will disappear in a few seconds.



2 Rotate the front/rear dials while the guide is displayed

3 Press [MENU/SET] and set

- You can also complete this step by performing either of the operations below:
 - Press the shutter button halfway
 - Press the rear dial

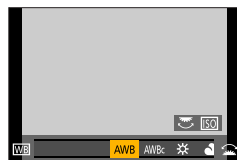













- You can set the items to be assigned temporarily to the front/rear dials in [Dial Operation Switch Setup] in [Dial Set.] in the [Custom] ([Operation]) menu. (→49)



■ Setting the operation methods of the front dial and rear dial

MENU →  **[Custom]** →  **[Operation]** → **[Dial Set.]**

[Assign Dial (F/SS)]	<p>Assigns the operations of the dials in Manual Exposure Mode.</p> <p>[ F  SS]: Assigns the aperture value to the front dial, and the shutter speed to the rear dial.</p> <p>[ SS  F]: Assigns the shutter speed to the front dial, and the aperture value to the rear dial.</p>														
[Rotation (F/SS)]	<p>Changes the rotation direction of the dials for adjusting the aperture value and shutter speed.</p> <p>[ ] / [ ]</p>														
[Exposure Dial]	<p>[ON]: Compensates the exposure with the Exposure Compensation dial. (-3 EV to +3 EV)</p> <p>[OFF]: The Exposure Compensation dial is disabled.</p> <ul style="list-style-type: none"> When [Exposure Dial] is set to [OFF], the Exposure Compensation screen can be displayed by pressing the rear dial. (-5 EV to +5 EV) (→112) 														
[Exposure Comp.]	<p>Assigns the Exposure Compensation to the front dial or the rear dial so that appropriate exposure can be achieved simply by rotating them when [Exposure Dial] is set to [OFF]. (-5 EV to +5 EV)</p> <p>[] (Front Dial) / [] (Rear Dial) / [OFF]</p>														
[Dial Operation Switch Setup]	<p>Sets the items to be assigned temporarily to the front/rear dials when you press the function button to which [Dial Operation Switch] is assigned.</p> <p>[] ([Front Dial Operation]) / [] ([Rear Dial Operation])</p> <ul style="list-style-type: none"> Items that can be set are as follows. <table border="0" data-bbox="331 851 802 1011"> <tbody> <tr> <td>- [4K Photo Mode]</td> <td>- [i.Resolution]</td> </tr> <tr> <td>- [Photo Style]</td> <td>- [Flash Mode]</td> </tr> <tr> <td>- [Filter Effect]</td> <td>- [Flash Adjust.]</td> </tr> <tr> <td>- [Aspect Ratio]</td> <td>- [Sensitivity]</td> </tr> <tr> <td>- [AF Mode]</td> <td>- [White Balance]</td> </tr> <tr> <td>- [Highlight Shadow]</td> <td>- [Drive Mode]</td> </tr> <tr> <td>- [i.Dynamic]</td> <td></td> </tr> </tbody> </table> [Highlight Shadow] uses the two dials. 	- [4K Photo Mode]	- [i.Resolution]	- [Photo Style]	- [Flash Mode]	- [Filter Effect]	- [Flash Adjust.]	- [Aspect Ratio]	- [Sensitivity]	- [AF Mode]	- [White Balance]	- [Highlight Shadow]	- [Drive Mode]	- [i.Dynamic]	
- [4K Photo Mode]	- [i.Resolution]														
- [Photo Style]	- [Flash Mode]														
- [Filter Effect]	- [Flash Adjust.]														
- [Aspect Ratio]	- [Sensitivity]														
- [AF Mode]	- [White Balance]														
- [Highlight Shadow]	- [Drive Mode]														
- [i.Dynamic]															



Cursor button / [MENU/SET] button (Selecting/setting items)

Pressing the cursor button:

Selection of items or setting of values etc., is performed.

Pressing [MENU/SET]:

Confirmation of setting contents, etc., is performed.

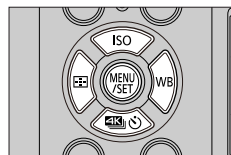

[DISP.] button (Switching the display information)

1 Press [DISP.] button to switch the display

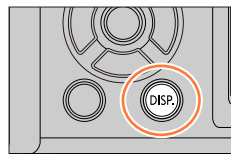

During recording

You can switch the viewfinder/monitor display method.

MENU → [Custom] → [Monitor / Display] → [LVF/Monitor Disp. Set]
→ [LVF Disp. Set] or [Monitor Disp. Set]

(viewfinder style)

Scales down images slightly so that you can better review the composition of the images.

(monitor style)

Scales images to fill the entire screen so that you can see their details.

Live View Finder style display layout (Example of viewfinder style display)

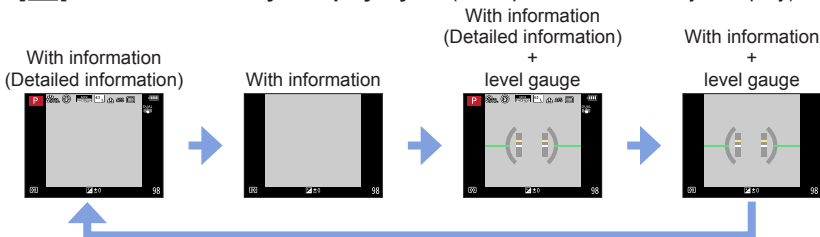

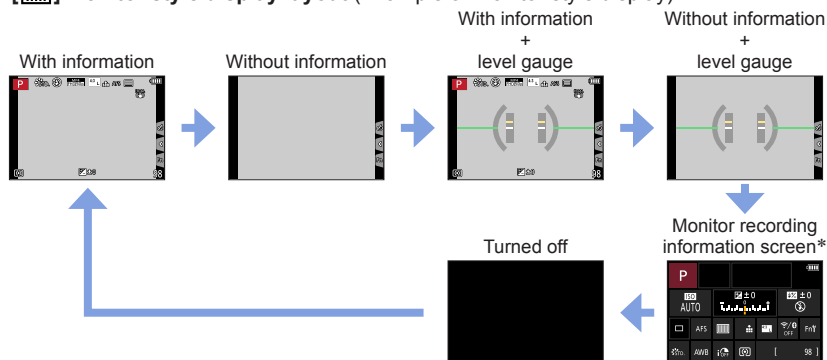

Buttons/Dials Used for Recording

■  **Monitor style display layout** (Example of monitor style display)



* This screen is displayed only when [Monitor Info. Disp.] in the [Custom] ([Monitor / Display]) menu is set to [ON]. Settings can be adjusted directly by touching each of the items displayed on the screen.

- With [Fn Button Set] in the [Custom] ([Operation]) menu, you can assign [LVF/Monitor Disp. Style] to a function button. Each time you press the assigned function button, the display style of the monitor or viewfinder ( / ), whichever is currently in use, will change.

Buttons/Dials Used for Recording

■ Using the level gauge

The yellow line indicates the current angle. Correct the angle of the camera so that it matches the white line.

Tilting up or down

- In this case, it is facing upward.

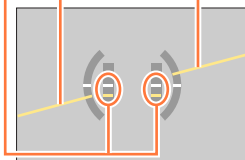
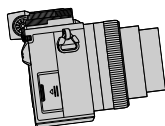

Tilting left or right

- In this case, the right side has dropped.

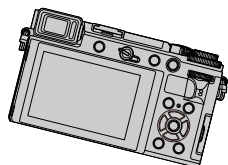

- When the camera is tilted very little or not at all, the level gauge will turn green.

- Even when angle is corrected, there may be an error of about ± 1 degree.
- The level gauge may not be displayed correctly or the direction detect function may not operate correctly if the pictures are taken with the camera pointing sharply up or down.

During playback

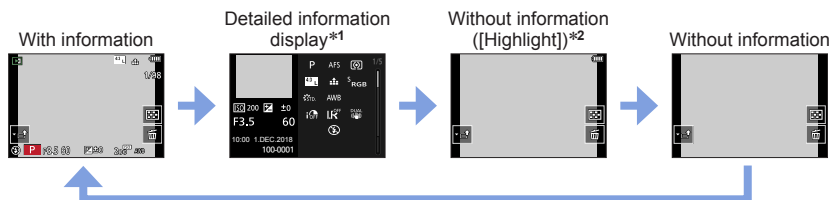

*1 Press \blacktriangle \blacktriangledown to switch between the following display modes:

- Detailed information display
- Histogram display
- Photo style, Highlight shadow display
- White balance display
- Lens information display

*2 This screen is displayed only when [Highlight] in the [Custom] ([Monitor / Display]) menu is set to [ON].



Touch screen (Touch operations)

Touch

To touch and release the touch screen.



Drag

To touch and slide your finger across the touch screen.



Pinch (spread/pinch)

On the touch screen, spread (pinch out) your 2 fingers to zoom in, and pinch (pinch in) your 2 fingers to zoom out.

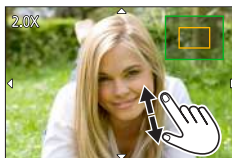

- Touch the screen with the clean and dry finger.
- If you use a commercially available monitor protection sheet, please follow the instructions that accompany the sheet. (Some monitor protection sheets may impair visibility or operability.)
- The touch screen may not function normally in the following cases.
 - When touched by a gloved hand
 - When the touch screen is wet



Focusing on the subject at the touched position (Touch AF, Touch Shutter)

Recording mode:   P A S M   



1 Touch []



2 Touch an icon

- The icon switches every time you touch it.



 (Touch AF)	Focuses on the position you touch.*
 (Touch shutter)	Focuses on the touched position before recording takes place.*
 (OFF)	Touch AF and Touch Shutter are disabled.

*When [Touch AF] in [Touch Settings] of the [Custom] ([Operation]) menu is set to [AF+AE], the focus and brightness are optimised for the touched position. (→107)

3 (When settings other than OFF are selected) Touch the subject

For details on changing the position and size of the AF area when the [] (Touch AF) is set, refer to (→103).



- If shooting with the touch shutter fails, the AF area turns red and disappears.

Matching the brightness to the touched position ([Touch AE])

Recording mode:   **P** **A** **S** **M**    

When the face of the subject appears dark, you can brighten the screen according to the brightness of the face.

1 Touch []



2 Touch []

- The setting screen for the brightness optimisation position is displayed.
- [Metering Mode] is set to [, which is used exclusively for the [Touch AE].



3 Touch the subject you want to optimise the brightness for

- Touching [Reset] will bring the brightness optimisation position back to the centre.



4 Touch [Set]

■ Cancelling the [Touch AE] function

Touch []

- This function is not available in the following cases:
 - When using the Digital Zoom
 - When recording using [4K Live Cropping]
 - When [Touch AF] in [Touch Settings] of the [Custom] ([Operation]) menu has been set to [AF+AE]

Setting the menu

Menu settings can be made either by button or touch operation.

1 Press [MENU/SET] to bring up the menu

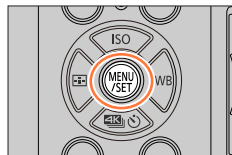

2 Switch the menu type

Ⓐ Menu type

① Press ◀







② Press ▲▼ to select a tab such as [🔧]
 • You can also select the tab by rotating the front dial.

③ Press [MENU/SET]

— With touch screen operations —

Touch a tab, such as [🔧]



 [Rec] (→189)	You can perform settings for the aspect ratio, number of pixels, 4K Photo, etc.
 [Motion Picture] (→205)	You can select the recording format and picture quality and other settings.
 [Custom] (→207)	Operation of the unit, such as displaying of the screen and button operations, can be set up according to your preferences.
 [Setup] (→223)	You can perform settings that make usage more convenient, such as the changing the clock settings and beep tone. You can also perform Wi-Fi/Bluetooth function-related settings.
 [My Menu] (→234)	You can register frequently used menus.
 [Playback] (→235)	You can perform settings for playback and editing pictures.

• Menus to be displayed in each recording mode (→188)



3 Press ▲▼ to select the menu item and press [MENU/SET]

- Ⓑ Item
- Ⓒ Page

With touch screen operations

Touch the menu item

- You can switch pages by touching Ⓒ on the right side of the display.

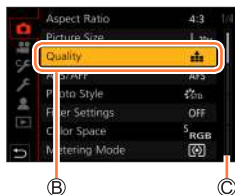

4 Press ▲▼ to select the setting and press [MENU/SET]

- Ⓓ Selected setting
- Ⓔ Settings

- The setting methods vary depending on the menu item.

With touch screen operations

Touch the setting to set

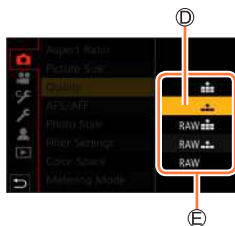

5 Press [Q.MENU/↵] button repeatedly until the recording or playback screen reappears

- During recording, the menu screen can also be exited by pressing the shutter button halfway.

With touch screen operations

Touch [↵]



- You can display an explanation on the menu by pressing the [DISP.] button while you select a menu item or setting.
- The menu items that cannot be set are greyed out. In some setting conditions, the reason the setting is disabled is displayed when you press [MENU/SET] if you select a greyed-out menu item.



- The operations such as selecting or setting menu items can also be made by the rear dial. Selecting can be done by rotating the rear dial, and setting by pressing the rear dial.

Calling frequently-used menus instantly (Quick Menu)

You can easily call some of the menu items and set them during recording.

1 Press [Q.MENU/↵] button

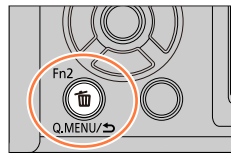

2 Rotate the front dial to select the menu item



3 Rotate the rear dial to select the setting

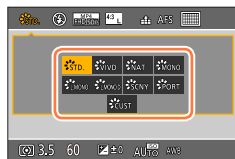

4 Press [Q.MENU/↵] button to close the Quick menu

Using the Quick menu on the monitor recording information screen (→51) of [INFO] (monitor style)

Select the item by pressing the [Q.MENU/↵] button and rotating the front dial, and then select the setting items by rotating the rear dial.



- When [Exposure Dial] in [Dial Set.] of the [Custom] ([Operation]) menu is set to [ON], rotate the Exposure Compensation dial to compensate the exposure.
- You can also use ▲▼◀▶ to select menu and setting items.
- Some items or settings cannot be selected depending on the mode or display style the camera is in.

Calling frequently-used menus instantly (Quick Menu)

Change the Quick Menu to your preferred item

Up to 15 items can be set to the Quick Menu.

MENU →  [Custom] →  [Operation] → **[Q.MENU]** → **[CUSTOM]**

- 1** After pressing the **[Q.MENU/↵]** button, press **▼** to select **[Q.M]**, and press **[MENU/SET]**



- 2** Press **▲▼◀▶** to select the menu item in the top row and press **[MENU/SET]**

(A) Top row: Items that can be set

(B) Bottom row: Set items

- Items that are displayed in light grey in the top row have already been set.

- 3** Press **◀▶** to select the empty space in the bottom row and press **[MENU/SET]**

- You can also set the menu item by dragging it from the top row to the bottom row.
- If there is no empty space in the bottom row, you can replace an existing item with a new select item by selecting the existing item.
- To cancel the setting, move to the bottom row by pressing **▼** and select an item to cancel, and then press **[MENU/SET]**.

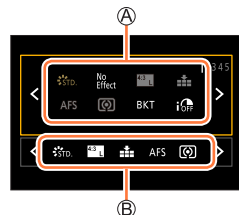

- 4** Press **[Q.MENU/↵]** button

- It will return to screen of step 1. Press **[MENU/SET]** to switch to the recording screen.

Assigning frequently used functions to the buttons

(Function buttons)

You can assign frequently-used functions to particular buttons ([Fn1] - [Fn3]) or icons displayed on the screen ([Fn4] - [Fn8]).

1 Set the menu

MENU → [Custom] → [Operation] → [Fn Button Set]

Settings: [Setting in REC mode] / [Setting in PLAY mode]

2 Press ▲ ▼ to select the function button you want to assign a function to and press [MENU/SET]

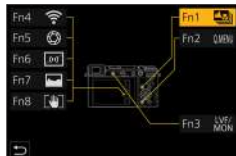

3 Press ▲ ▼ to select the function you want to assign and press [MENU/SET]

- For details on the functions that can be assigned in [Setting in REC mode], refer to (→61).
- For details on the functions that can be assigned in [Setting in PLAY mode], refer to (→62).

■ Configuring the function button settings from the monitor recording information screen

Touching [Fn4] on the monitor recording information screen (→51) also allows you to display the screen in step 2.

■ Rapidly assigning functions

The screen displayed in Step 3 can be displayed by holding a function button ([Fn1] to [Fn3]) for 2 seconds.

- Certain functions cannot be assigned to some function buttons.
- The function assigned to the function button may not work in some modes or on some display screens.

Assigning frequently used functions to the buttons (Function buttons)

Using the function buttons during recording

Press the function button to use the assigned function.

Using function buttons with touch operations

- ① Touch [Fn]
- ② Touch [Fn4], [Fn5], [Fn6], [Fn7] or [Fn8]



Functions that can be assigned in [Setting in REC mode]

- | | | |
|---------------------------------|--------------------------------|---------------------------|
| • [4K Photo Mode] | • [Picture Size] | • [Motion Pic. Set] |
| • [Post Focus]: [Fn1]*1 | • [Quality] | • [Picture Mode in Rec.] |
| • [Wi-Fi]: [Fn4]*1 | • [AFS/AFF] | • [Sound Rec Level Adj.] |
| • [Q.MENU]: [Fn2]*1 | • [Metering Mode] | • [Silent Mode] |
| • [Video Record] | • [Bracket] | • [Peaking] |
| • [LVF/Monitor Switch]: [Fn3]*1 | • [Highlight Shadow] | • [Histogram]: [Fn7]*1 |
| • [LVF/Monitor Disp. Style] | • [i.Dynamic] | • [Guide Line] |
| • [AF/AE LOCK] | • [i.Resolution] | • [Zebra Pattern] |
| • [AF-ON] | • [Min. Shtr Speed] | • [Monochrome Live View] |
| • [Preview]: [Fn5]*1 | • [HDR] | • [Constant Preview] |
| • [One Push AE] | • [Shutter Type] | • [Live View Boost] |
| • [Touch AE] | • [Flash Mode] | • [Rec Area] |
| • [Level Gauge]: [Fn6]*1 | • [Flash Adjust.] | • [Step Zoom] |
| • [Focus Area Set] | • [Wireless Flash Setup] | • [Zoom Speed] |
| • [Zoom Control] | • [Ex. Tele Conv.] | • [Sensitivity] |
| • [Operation Lock] | • [Digital Zoom] | • [White Balance] |
| • [Dial Operation Switch] | • [Stabilizer] | • [AF Mode/MF] |
| • [Photo Style] | • [i.S. Lock (Video)]: [Fn8]*1 | • [Drive Mode] |
| • [Filter Effect] | • [4K Live Cropping] | • [Rec / Playback Switch] |
| • [Aspect Ratio] | • [Snap Movie] | • [Off]*2 |

*1 Function button settings at the time of purchase.

*2 No function is assigned to function buttons.



Assigning frequently used functions to the buttons (Function buttons)

- When [Video Record] is assigned to the function button, you can start and stop recording motion pictures in the same way as pressing the motion picture button.
- When [Focus Area Set] is assigned to the function button, you can display the AF area or the MF Assist position setting screen.
- When [Operation Lock] is assigned to the function button, you can disable the operations that were set using [Operation Lock Setting] in the [Custom] ([Operation]) menu. To cancel the lock, press the function button to which [Operation Lock] is assigned again.
- When [Rec / Playback Switch] is assigned to the function button, you can switch between recording mode and playback mode.
- To restore the default function button settings, select [Restore to Default] in step 3 (→60).
- If the screen displays (A) or similar, the displayed operation will be performed instead of the function assigned to function buttons by [Fn Button Set].

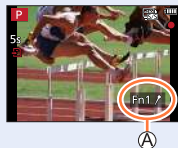

Using the function buttons during playback

You can directly set an assigned function to a selected image by pressing the function button during playback.

Example: When [Fn1] is set to [Rating★3]

- 1 Press ◀▶ to select the picture
- 2 Press [Fn1] button, and then set the picture as [Rating★3]



■ Functions that can be assigned in [Setting in PLAY mode]

- The following functions can be assigned to the button [Fn1] or [Fn3].

- | | | |
|---------------------------------|-----------------------|--------------------------|
| • [Wi-Fi] | • [Protect] | • [Rating★5] |
| • [LVF/Monitor Switch]: [Fn3]*1 | • [Rating★1] | • [RAW Processing] |
| • [Rec / Playback Switch] | • [Rating★2] | • [4K PHOTO Bulk Saving] |
| • [4K PHOTO Play] | • [Rating★3]: [Fn1]*1 | • [Off]*2 |
| • [Delete Single] | • [Rating★4] | |

*1 Function button settings at the time of purchase.

*2 No function is assigned to function buttons.

- To restore the default function button settings, select [Restore to Default] in step 3 (→60).



Entering Text

Follow the steps below when the text entry screen is displayed.

1 Use ▲▼◀▶ to select characters

2 Press [MENU/SET] several times until the desired character is displayed

- [□]: Enter a blank.

■ To change the character type

- Press [DISP.] button
- Use ▲▼◀▶ to select [☰] and press [MENU/SET]

■ To continue entering characters

- Use ▲▼◀▶ to select [>] and press [MENU/SET]
- Rotate the rear dial to the right.

■ To edit text

- ① Use ▲▼◀▶ to select [<] [>] and press [MENU/SET]. Then, move the cursor to the text to edit
 - You can also rotate the rear dial to reposition the cursor.
- ② Use ▲▼◀▶ to select [Delete] and press [MENU/SET]
- ③ Use ▲▼◀▶ to select the correct text, and press [MENU/SET]





3 When you are finished entering text, use ▲▼◀▶ to select [Set] and press [MENU/SET]

- A maximum of 30 characters can be entered (maximum of 9 characters when setting names in [Face Recog.]).
- A maximum of 15 characters can be entered for [\\], [Γ], [J], [•] and [—] (maximum of 6 characters when setting names in [Face Recog.]).



Taking pictures with automatic settings

(Intelligent Auto Mode)

Recording mode:  

This mode is recommended for those who want to point and shoot as the camera optimises settings to match the subject and recording environment.

1 Set mode dial to [iA]

- At the time of purchase, the mode is set to Intelligent Auto Plus Mode.

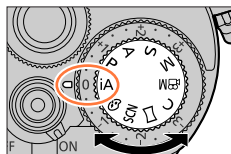



2 Point the camera at the subject

- When the camera identifies the optimal scene, the icon for each scene turns blue for 2 seconds and then changes to the normal red indication. (Automatic Scene Detection)





■ Switching between Intelligent Auto Plus Mode and Intelligent Auto Mode

- ① Select [Intelligent Auto Mode] in [Intelligent Auto] menu
- ② Press ▲ ▼ to select  or  and press [MENU/SET]





It is also possible to display the selection screen by touching the Recording mode icon in recording screen.



 allows you to adjust some settings such as the brightness and colour tone while also using  for other settings so that you can record pictures more suited to your preferences.

(○: Available, -: Not available)

	 Intelligent Auto Plus Mode	 Intelligent Auto Mode
Setting the colour tone	○	-
Setting the brightness (exposure)	○	-
Defocus control function	○	-
Menus that can be set	Many	Few



Taking pictures with automatic settings (Intelligent Auto Mode)

Auto Focus, Face/Eye Detection, and Face Recognition

[AF Mode] is automatically set to [i:👤]. If you touch the subject, the camera switches to [i:👤] and the AF tracking function starts operating.

- You can also switch to [i:👤] by pressing the cursor button ◀. Align the AF tracking area with the subject and press the shutter button halfway to operate the AF tracking function.
- When [Face Recog.] is set to [ON] and if the camera recognises a face similar to a registered face, [R] is displayed on the upper right corner of the [i:👤], [i:👤], and [i:👤] icons.

Flash

When the flash is open, the camera will automatically be set to [i:🔆], [i:🔆] (Auto/Red-Eye Reduction), [i:🔆], or [i:🔆], depending on the type of subject and brightness.

- When [i:🔆] or [i:🔆] is displayed, the [Red-Eye Removal] function is activated to automatically detect red-eye and correct the picture data.
- When [i:🔆] or [i:🔆] is selected, the shutter speed is reduced.

Automatic Scene Detection

When taking pictures

[i-Portrait]	[i-Scenery]	[i-Macro]
[i-Night Portrait]*1	[i-Night Scenery]	[i-Handheld Night Shot]*2
[i-Food]	[i-Baby]*3	[i-Sunset]
/ When scene does not correspond to any of the above		

When recording motion pictures

[i-Portrait]	[i-Scenery]	[i-Low Light]	[i-Macro]
/ When scene does not correspond to any of the above			

*1 Displayed only when using flash.

*2 When [i-Handheld Night Shot] is [ON].

*3 When children (that are registered in the camera with Face Recognition) under 3 years old are recognised.



Taking pictures with automatic settings (Intelligent Auto Mode)

- When the camera identifies [iA] as the optimal scene and if the camera determines that jitter is reduced by the use of a tripod or by other means, a shutter speed that is slower than usual is selected. After pressing the shutter button, do not move the camera while recording.
- When recording 4K photos or when recording using [Post Focus], Scene Detection works the same way as when recording motion pictures.

- Depending on recording conditions, different scene types may be determined for the same subject.



About Backlight Compensation

Backlight compensation is automatically activated in Intelligent Auto Plus Mode or Intelligent Auto Mode. Backlight is a condition where a light shines from behind a subject. When there is a backlight, the subject appears darker and the camera will automatically attempt to correct it by increasing the brightness of the picture.

[Intelligent Auto] menu

Taking pictures using a handheld camera ([iHandheld Night Shot])

Recording mode:

If a night scene is detected automatically while the unit is being handheld, [iHandheld Night Shot] can record a still picture with less jitter and less noise without using a tripod by combining a burst of pictures.

MENU → / [Intelligent Auto] → [iHandheld Night Shot]

Settings: [ON] / [OFF]

- The angle of view becomes narrow slightly.
- After the shutter button has been pressed, do not move the camera during the burst operation.
- The flash is fixed to the (Forced Flash Off) setting.
- This function will not work for still pictures while motion pictures are being recorded.
- This function is not available in the following cases:
 - When using [Burst]
 - When recording 4K photos
 - When recording using [Post Focus]
 - When recording using [Bracket]
 - When [Quality] is set to [RAW] , [RAW] or [RAW]
 - When [Ex. Tele Conv.] ([Rec]) is set
 - When using [Time Lapse Shot]
 - When [Auto Shooting] of [Stop Motion Animation] is set to [ON]



Taking pictures with automatic settings (Intelligent Auto Mode)

Combining pictures into a single still picture with rich gradation ([iHDR])

Recording mode:  

When there is, for example, strong contrast between the background and the subject, [iHDR] records multiple still pictures with differing exposures and combines them to create a single still picture rich in gradation.

[iHDR] is activated when required. When activated, [iHDR] will be displayed on the screen.

MENU →  /  [**Intelligent Auto**] → [**iHDR**]

Settings: [ON] / [OFF]

- The angle of view becomes narrow slightly.
- After the shutter button has been pressed, do not move the camera during the burst operation.
- Since a burst of still pictures are combined after they have been recorded, it will be a few moments before you can record another picture.
- In the case of composition from a burst, afterimages may appear if the subject was moving.
- This function will not work for still pictures while motion pictures are being recorded.
- This function is not available in the following cases:
 - When recording using the flash
 - When using [Burst]
 - When recording 4K photos
 - When recording using [Post Focus]
 - When recording using [Bracket]
 - When [Quality] is set to [RAW], [RAW] or [RAW]
 - When [Ex. Tele Conv.] ([Rec]) is set
 - When using [Time Lapse Shot]
 - When [Auto Shooting] of [Stop Motion Animation] is set to [ON]

Setting colouring

Recording mode: **1** Press ► to display the setting screen**2** Rotate the rear dial to adjust colour

- Press [MENU/SET] to return to the recording screen.
- The colour setting will return to the default level (centre point) when this unit is turned off or the camera is switched to another Recording mode.
- With touch screen operations (→68)



Setting brightness (exposure)/blurriness of the background (Defocus control function)

Recording mode: 

When [Exposure Dial] (→49) is set to [ON]

1 Rotate the Exposure Compensation dial to set the brightness

- You can set the exposure compensation value in the range between -3 EV and +3 EV.
- You can set the blurriness of the background with touch screen operations (below).

When [Exposure Dial] (→49) is set to [OFF]

1 Press the rear dial to display the setting screen

- The brightness (exposure) operation screen is displayed. Press [Fn1] to operate the defocus control, and then press it again to finish the operation.

2 Rotate the rear dial to set

- Press [MENU/SET] to return to the recording screen.

When setting the brightness (exposure)

- You can set the exposure compensation value in the range between -5 EV and +5 EV.
- Press ▲▼ to set the Exposure Bracket. (→142)

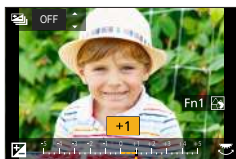

When setting the background defocusing

- Pressing [Q.MENU/↵] button will cancel the setting.
- Auto Focus Mode is set to [□]. The position of the AF area can be set by touching the screen. (Its size cannot be changed.)

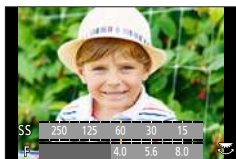



■ With touch screen operations

① Touch 

② Touch the item you want to set

: Colouring

: Degree of defocusing

: Brightness (Displayed only when [Exposure Dial] is set to [OFF])

③ Drag the slide bar or exposure meter to set

- Press [MENU/SET] to return to the recording screen.



- Depending on the lens used, you may hear a sound from the lens while operating Defocus Control. This is due to the aperture operation of the lens and is not a malfunction.
- Depending on the lens used, operational sound of the Defocus Control may be recorded during the recording of a motion picture when the function is used.

Taking pictures after automatically setting the aperture value and shutter speed (Programme AE Mode)

Recording mode: **[P]**

Take pictures using automatic aperture values and shutter speed settings in accordance with the brightness of a subject.

1 Set mode dial to [P]

2 Press the shutter button halfway

- If the aperture value and shutter speed flash red, you do not have the correct exposure.

3 While the numeric values are displayed (approximately 10 seconds), rotate the rear or front dial to change the values using Programme Shift

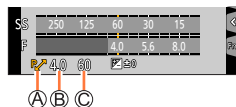

(A) Programme Shift indication

(B) Aperture value

(C) Shutter speed

- It will switch between Programme Shift operation and Exposure Compensation operation (→112) every time the rear dial is pressed while the values are displayed (only when [Exposure Dial] (→49) is set to [OFF]).
- To cancel Programme Shift, either turn off the camera or rotate the rear or front dial until the Programme Shift indication turns off.
- Programme Shift can easily be cancelled by setting a function button to [One Push AE]. (→60, 75)

About Programme Shift

The function for maintaining the same exposure (brightness) while changing the aperture value and shutter speed combination is called “Programme Shift”. You can use “Programme Shift” to take pictures by adjusting the aperture value and shutter speed even in Programme AE Mode.

- Programme Shift cannot be used in the following cases:
 - When recording using the flash
 - When recording 4K photos
 - When recording using [Post Focus]
 - When ISO sensitivity is set to [i]ISO



Taking pictures by setting the aperture value and shutter speed

Recording mode: **[A][S][M]**

- The effect of the aperture value and shutter speed you have set is not applied to the recording screen. To check the effect on the recording screen, use Preview Mode. (→74)
- The brightness of the screen may vary from the actual pictures recorded. Check the brightness of pictures using the playback screen.
- When you adjust the aperture value and shutter speed, an exposure meter is displayed. If aperture and shutter speed are shown in red, you do not have appropriate exposure.
- If the correct exposure is not achieved when you press the shutter button halfway, the numeric values of the aperture and shutter speed are displayed in flashing red.

Taking pictures by setting the aperture value (Aperture-Priority AE Mode)

When you set the aperture value, the camera automatically optimises the shutter speed for the brightness of the subject.

1 Set mode dial to [A]

2 Rotate the rear or front dial to set the aperture value

- The mode will switch between Aperture Setting operation and Exposure Compensation operation every time you press the rear dial. (Only when [Exposure Dial] (→49) is set to [OFF])

- Ⓐ Aperture value
- Ⓑ Exposure meter

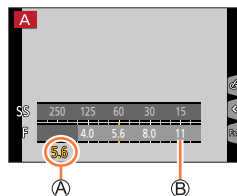

- When using a lens having an aperture ring, set the position of the aperture ring to [A] to activate the front/rear dial settings. At positions other than [A], the ring setting takes priority.

Taking pictures by setting the aperture value and shutter speed

Taking pictures by setting the shutter speed (Shutter-Priority AE Mode)

When you set the shutter speed, the camera automatically optimises the aperture value for the brightness of the subject.

1 Set mode dial to [S]

2 Rotate the rear or front dial to set the shutter speed

- It will switch between shutter speed setting operation and Exposure Compensation operation every time the rear dial is pressed (only when [Exposure Dial] (→49) is set to [OFF]).

- Ⓐ Shutter speed
- Ⓑ Exposure meter

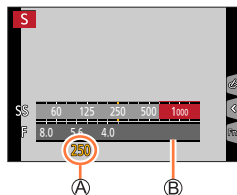

- When the flash is activated, the fastest shutter speed that can be selected is 1/200th of a second.

Taking pictures by setting the aperture value and shutter speed

Taking pictures by setting the aperture value and shutter speed (Manual Exposure Mode)

Determine the exposure by manually setting the aperture value and the shutter speed.

1 Set mode dial to [M]

2 Rotate the rear dial to set the shutter speed, and rotate the front dial to set the aperture value

- Ⓐ Aperture value
- Ⓑ Shutter speed
- Ⓒ Manual Exposure Assist
- Ⓓ Exposure meter

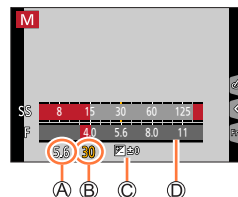

Shutter speeds that can be set (seconds)

T (Time), 60 - 1/4000

(When the mechanical shutter is used)

1 - 1/16000

(When the electronic shutter is used)



Optimising the ISO sensitivity for the aperture value and shutter speed

When the ISO sensitivity is set to [AUTO], the camera sets the ISO sensitivity automatically so that the exposure will be appropriate for the aperture value and shutter speed.

- Depending on recording conditions, an appropriate exposure may not be set or the ISO sensitivity may become higher.



Manual exposure assist (estimate)



Shows pictures with standard brightness (appropriate exposure).



Shows brighter pictures. For the appropriate exposure, either use a faster shutter speed or increase aperture value.



Shows darker pictures. For the appropriate exposure, either use a slower shutter speed or reduce aperture value.

- When you use a lens with an aperture ring, the aperture ring setting takes priority.
- When the flash is activated, the fastest shutter speed that can be selected is 1/200th of a second.



Taking pictures by setting the aperture value and shutter speed

About [T] (Time) (Approximately up to 30 minutes)

If you set the shutter speed to [T], the shutter stays open when the shutter button is pressed fully. The shutter closes if you press the shutter button again. Use this function when you want to keep the shutter open for an extended period, for example, to record pictures of fireworks or night scenes.



- When the shutter speed is set to [T] (time), we recommend using a tripod and taking pictures remotely by connecting the camera to a smartphone via Wi-Fi connection to prevent camera shake. [B] (Bulb) is also available when connected via Bluetooth. (→265, 267)
- When you take still pictures with the shutter speed set to T (time), the pictures may have higher noise levels. If you want to suppress noise, we recommend taking pictures by setting [Long Shtr NR] to [ON] in the [Rec] menu. (→199)

● This function is not available in the following cases:

- When recording using the flash (Only when [Flash Synchro] is set to [2ND])
- When recording 4K photos
- When recording using [Post Focus]
- When recording using [Bracket]
- When [HDR] is set to [ON]
- When using the electronic shutter
- When [Silent Mode] is set to [ON]
- When using [Time Lapse Shot]
- When [Auto Shooting] of [Stop Motion Animation] is set to [ON]



Taking pictures by setting the aperture value and shutter speed

Checking the effects of the aperture value and shutter speed (Preview Mode)

Recording mode:

- **Checking the effect of the selected aperture value:** This enables you to check the depth of field (focus range) by physically narrowing the lens aperture blades to the aperture value used for the actual recording.
- **Checking the effect of the selected shutter speed:** This allows you to check motion in a scene by displaying the screen at the shutter speed used for the actual recording.

Preparations

- Assign [Preview] to the function button (→60)

The following step is an example of assigning [Preview] to the [Fn5] button.

1 Press the [Fn5] button to switch the confirmation screen

- Every time you press the [Fn5] button, the screen switches.

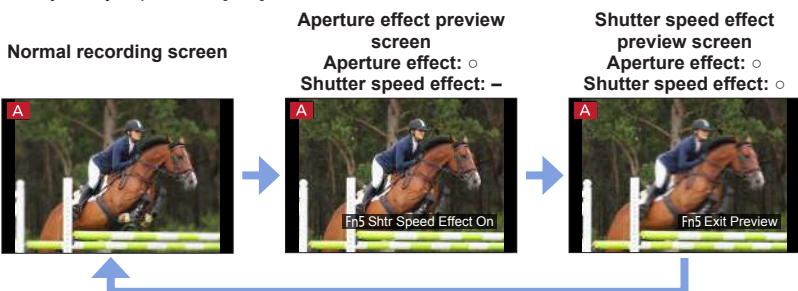

Depth of field characteristic

Recording conditions	Aperture value	Small	Large
	Focal length	Telephoto	Wide-angle
	Distance to a subject	Close	Far
Depth of field (Focus range)		Shallow (narrow) Example: To take a picture by deliberately blurring the background	Deep (wide) Example: To take a picture by adjusting the focus while including the background

Taking pictures by setting the aperture value and shutter speed

- You can take a picture even when Preview Mode is activated.
- The range in which you can check the effect of a selected shutter speed is between 8 seconds and 1/16000 seconds.
- This mode cannot be used with [] (4K Pre-Burst) of 4K Photo.

Easily set aperture value / shutter speed for suitable exposure (One Push AE)

Recording mode: **P** **A** **S** **M**

When the exposure setting is too bright or too dark, you can use one push AE to achieve a suitable exposure setting.



How to tell if the exposure is not adequate

A Blinks red

- If the aperture values and shutter speed blink red when the shutter button is pressed halfway.
- If the Manual Exposure Assistance (→72) is anything other than [] when in Manual Exposure Mode.

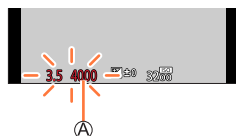

Preparations

- Assign [One Push AE] to the function button (→60)

1 (When exposure is not adequate) Press the function button

B Change to appropriate exposure

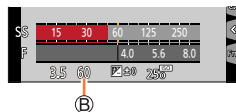

- In the following cases, suitable exposure cannot be set.
 - When the subject is extremely dark and it is not possible to achieve adequate exposure by changing the aperture value or shutter speed
 - When recording using the flash
 - Preview Mode
 - When using a lens that includes an aperture ring



Recording panorama pictures (Panorama Shot Mode)

Recording mode: 

Consecutive photos taken while the camera is moved are combined to form a panorama.

- 1** Set mode dial to 
- 2** Press the shutter button halfway to focus
- 3** Press the shutter button fully and pan the camera in a small circular motion to the recording direction to start recording

Ⓐ Horizontal/vertical guide line

Ⓑ Recording direction and progress status (approximate)

Taking pictures from left to right

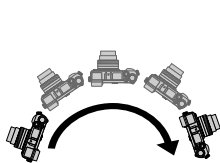

Image size: [STANDARD]

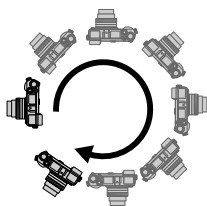
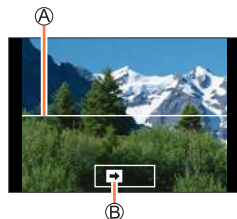

Image size: [WIDE]



- Pan the camera at a constant speed.

- You may not be able to take pictures successfully if you move the camera too quickly or too slowly.

- 4** Press the shutter button fully again to end recording

- You can also end recording if you stop panning the camera while taking pictures.
- Recording can also be ended by moving the camera to the end of the guide.



Recording panorama pictures (Panorama Shot Mode)

■ Changing the recording direction and angle of view (image size) of panorama pictures

MENU →  [**Panorama Shot**] → [**Direction**] / [**Picture Size**]

[Direction]	Sets the recording direction.
[Picture Size]	Sets the angle of view (image size). [STANDARD] / [WIDE]

- The number of recording pixels per horizontal line and vertical line of a panorama picture varies depending on the picture size, recording direction and number of stitched pictures. The maximum number of recording pixels is as follows:

Image size	Recording direction	Horizontal Resolution	Vertical Resolution
[STANDARD]	Horizontal	8176 pixels	1920 pixels
	Vertical	2560 pixels	7680 pixels
[WIDE]	Horizontal	8176 pixels	960 pixels
	Vertical	1280 pixels	7680 pixels



Tips

Pan the camera in the recording direction as steadily as possible.

(If the camera shakes too much, it may not be able to take pictures or may end up creating a narrow (small) panorama picture.)







- A** Pan the camera to a point slightly ahead of the point that you want to take.
(However, the last frame is not recorded to the end.)

Recording panorama pictures (Panorama Shot Mode)

About panorama picture playback

Pressing ▲ will start scrolling playback automatically in the same direction as the recording.

- The following operations can be performed during scrolling playback.

		Start panorama playback / Pause*
		Stop



*When the playback is paused, you can scroll forwards and backwards by dragging the screen. When the scroll bar is touched, the playback position jumps to the touched position.

- Move the camera slowly when the focal length is large, such as when a telephoto lens is mounted.
- The focus, exposure and White Balance are all fixed to optimal values for the first picture. If the focusing or brightness of pictures recorded as part of a panorama picture after the first picture are significantly different from those of the first picture, the panorama picture as a whole (when all pictures are stitched together) may not have consistent focus and brightness.
- Since several pictures are stitched together to create a panorama picture, some subjects may be distorted or the joining portions of successively taken pictures that are stitched may be noticeable.
- Panorama pictures may not be created or pictures may not be recorded properly when taking pictures of the following subjects or when taking pictures in the following recording conditions:
 - Subjects that have a continuous monotone or pattern (sky, beach, etc.)
 - Moving subjects (person, pet, vehicle, waves, or flowers swaying in the wind, etc.)
 - Subjects whose colours or patterns change quickly (such as an image appearing on a display)
 - Dark locations
 - Locations with a flickering light source (fluorescent lamp, candle light, etc.)



Taking pictures according to the scene (Scene Guide Mode)

Recording mode: **[SCN]**

If you select a scene to suit the subject and recording conditions with reference to the example images, the camera will set optimal exposure, colour, and focus, allowing you to record in a manner appropriate to the scene.

1 Set mode dial to [SCN]

2 Press ◀▶ to select the scene

- The scene can also be selected by dragging an example image or the slide bar.

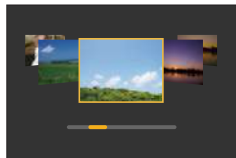

3 Press [MENU/SET]



It is also possible to display the selection screen by touching the Recording mode icon in recording screen.



- Depending on the scene, the recording screen may seem as if frames are missed.
- To change the scene, select [Scene Switch] in the [Scene Guide] menu, and then press [MENU/SET]. You can return to step 2.
- Some of the recording menu items cannot be set in Scene Guide Mode because the camera automatically adjusts the settings to the optimal values.
- Although White Balance is fixed to [AWB] for certain types of scenes, you can fine tune the White Balance or use White Balance bracketing by pressing the cursor button ▶ on the recording screen.



Taking pictures according to the scene (Scene Guide Mode)

Types of Scene Guide Mode



Displaying the description of each scene and recording tips

Press [DISP.] button while the scene selection screen is displayed

- When it is set to the guide display, detailed explanations and tips for each scene are displayed.

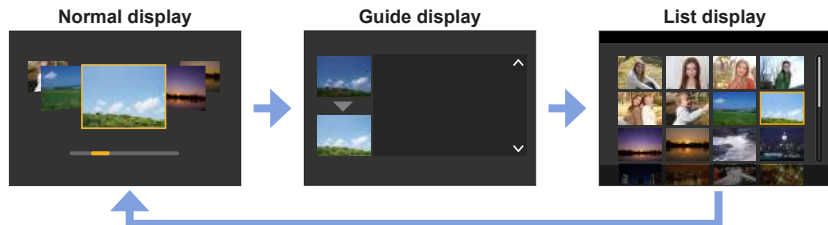

1: [Clear Portrait]

2: [Silky Skin]

- If a part of the background etc. is a colour close to skin colour, this part is also smoothed.
- This mode may not be effective when there is insufficient brightness.

3: [Backlit Softness]

4: [Clear in Backlight]

5: [Relaxing Tone]

6: [Sweet Child's Face]

- When you touch the face, a still picture is recorded with the focus and exposure set for the touched location.

7: [Distinct Scenery]



Taking pictures according to the scene (Scene Guide Mode)

8: [Bright Blue Sky]**9: [Romantic Sunset Glow]****10: [Vivid Sunset Glow]****11: [Glistening Water]**

- Star filter used in this mode may cause glistening effects on the objects other than water surface.

12: [Clear Nightscape]**13: [Cool Night Sky]****14: [Warm Glowing Nightscape]****15: [Artistic Nightscape]****16: [Glittering Illuminations]****17: [Handheld Night Shot]**

- After the shutter button has been pressed, do not move the camera during the burst operation.
- The angle of view becomes narrow slightly.

18: [Clear Night Portrait]

- Tripod, self-timer recommended.
- When [Clear Night Portrait] is selected, keep the subject still for about 1 second after taking the picture.

19: [Soft Image of a Flower]

- For close-up recording, we recommend that you avoid using the flash.



Taking pictures according to the scene (Scene Guide Mode)

20: [Appetizing Food]

- For close-up recording, we recommend that you avoid using the flash.

21: [Cute Dessert]

- For close-up recording, we recommend that you avoid using the flash.

22: [Freeze Animal Motion]

- Default [AF Assist Lamp] setting is [OFF].

23: [Clear Sports Shot]**24: [Monochrome]**

Taking Pictures with different picture effects

(Creative Control Mode)

Recording mode: 

You can select the effects to be applied from sample pictures and preview these effects on the screen.

1 Set mode dial to

2 Press ▲ ▼ to select the picture effect (filters)

 Preview display

- You can also select the picture effects (filters) by touching the example images.

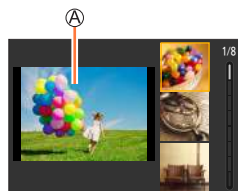

3 Press [MENU/SET]



It is also possible to display the selection screen by touching the Recording mode icon in recording screen.



- Depending on the picture effect, the recording screen may seem as if frames are missed.
- [White Balance] will be fixed to [AWB] and ISO sensitivity to [AUTO].
- The following menu items can be set in the [Creative Control] menu.
 - [Filter Effect]: Allows you to set the picture effect (filter).
 - [Simultaneous Record w/o Filter]: Allows you to set the camera to take a picture with and without a picture effect simultaneously. (→195)



Taking Pictures with different picture effects (Creative Control Mode)

**Displaying the description of each picture effect (Filter)**

Press [DISP.] button while the picture effect selection screen is displayed

- When it is set to the guide display, explanations for each picture effect are displayed.

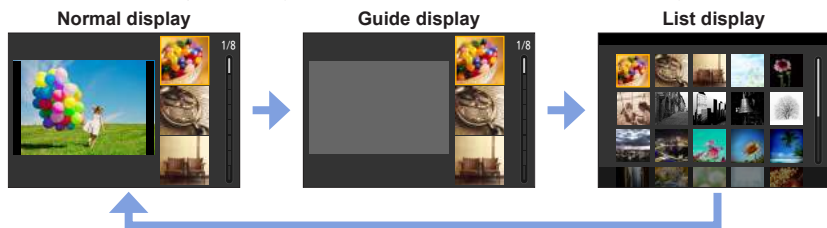

Types of picture effects

Adjusting the picture effects according to your preferences

- 1 Press ► to display the setting screen
- 2 Rotate the rear dial to adjust the setting conditions of the picture effects
 - Press [MENU/SET] to return to the recording screen.

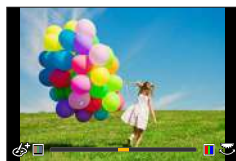

Taking Pictures with different picture effects (Creative Control Mode)

Picture effect	Items that can be set
[Expressive]	Vividness Subdued colouring ↔ Gaudy colouring
[Retro]	Colouring Yellowish colouring ↔ Reddish colouring
[Old Days]	Contrast Low contrast ↔ High contrast
[High Key]	Colouring Pinkish colouring ↔ Light-bluish colouring
[Low Key]	Colouring Reddish colouring ↔ Bluish colouring
[Sepia]	Contrast Low contrast ↔ High contrast
[Monochrome]	Colouring Yellowish colouring ↔ Bluish colouring
[Dynamic Monochrome]	Contrast Low contrast ↔ High contrast
[Rough Monochrome]	Grainy picture effect Weak grainy picture effect ↔ Strong grainy picture effect
[Silky Monochrome]	Degree of defocusing Slight defocusing ↔ Strong defocusing
[Impressive Art]	Vividness Black & white ↔ Gaudy colouring
[High Dynamic]	Vividness Black & white ↔ Gaudy colouring
[Cross Process]	Colouring Greenish colouring / Bluish colouring / Yellowish colouring / Reddish colouring <ul style="list-style-type: none"> Select the desired colour tone by rotating the rear dial, and press [MENU/SET]. 
[Toy Effect]	Colouring Orangish colouring ↔ Bluish colouring
[Toy Pop]	Range in which peripheral brightness is reduced Small ↔ Large
[Bleach Bypass]	Contrast Low contrast ↔ High contrast
[Miniature Effect]	Vividness Subdued colouring ↔ Gaudy colouring <ul style="list-style-type: none"> For details about [Miniature Effect] (→86)



Taking Pictures with different picture effects (Creative Control Mode)

Picture effect	Items that can be set
[Soft Focus]	Degree of defocusing Slight defocusing ↔ Strong defocusing
[Fantasy]	Vividness Subdued colouring ↔ Gaudy colouring
[Star Filter]	[⋯×] Length of the rays of light Rays of light is short ↔ Rays of light is long [×*] Number of the rays of light Smaller ↔ Larger [×] Angle of the rays of light Rotate to the left ↔ Rotate to the right
[One Point Color]	Amount of colour retained Leaves a small amount of colour ↔ Leaves a large amount of colour • For details about [One Point Color] (→87)
[Sunshine]	Colouring Yellowish colouring / Reddish colouring / Bluish colouring / Whitish colouring • Rotate the rear dial to select colouring, and press [MENU/SET].  • For details about [Sunshine] (→87)

■ Setting the type of defocus ([Miniature Effect])

- ① After touching [📷], touch [📐]
- ② Press ▲▼ or ◀▶ to move the focusing area (frame)
 - You can also move the in-focus portion by touching the screen on the recording screen.
 - Touching [📐] allows you to set the recording orientation (defocus orientation).
- ③ Rotate the rear dial to select the size of the focusing area (frame)
 - On the touch screen, spread (pinch out) your 2 fingers to zoom in, and pinch (pinch in) your 2 fingers to zoom out.
 - When you press [DISP.] button, the initial setting condition is restored.
- ④ Press [MENU/SET]



Taking Pictures with different picture effects (Creative Control Mode)

- No audio is recorded for motion pictures.
- When a motion picture is recorded, the finished recording will be approximately 1/8th of the actual recorded time period. (If you record a motion picture for 8 minutes, the resulting motion picture recording time will be approximately 1 minute.) The recordable time displayed on the camera is approx. 8 times of the actual recording time.
Depending on the recording frame rate of the motion picture, the recording time of the motion picture and the available recording time may differ from the values above.
- If you stop recording motion pictures too soon, the camera may continue recording until a certain time.

■ Selecting the colour to be retained ([One Point Color])

- ① After touching [📷], touch [🎨]
- ② Select the colour to be retained with ▲▼◀▶ and press [MENU/SET]
 - You can also select it by touch operations.
 - When you press [DISP.] button, the initial setting condition is restored.



- The selected colour may not be retained for some subjects.

■ Setting the position and size of the light source ([Sunshine])

- ① After touching [📷], touch [☀️]
- ② Press ▲▼◀▶ to move the centre of the light source to a different position
 - The position of the light source can also be moved by touching the screen.
- ③ Rotate the rear dial to adjust the size of the light source
 - On the touch screen, spread (pinch out) your 2 fingers to zoom in, and pinch (pinch in) your 2 fingers to zoom out.
 - When you press [DISP.] button, the initial setting condition is restored.
- ④ Press [MENU/SET]



Tips on positioning the centre of the light source

You can move the centre of the light source to a point outside the image to obtain a more natural finish.

Taking Pictures with different picture effects (Creative Control Mode)

Setting brightness (exposure)/blurriness of the background (Defocus control function)

When [Exposure Dial] (→49) is set to [ON]

1 Rotate the Exposure Compensation dial to set the brightness

- You can set the exposure compensation value in the range between -3 EV and $+3$ EV.
- You can set the blurriness of the background with touch screen operations (below).

When [Exposure Dial] (→49) is set to [OFF]

1 Press the rear dial to display the setting screen

- The brightness (exposure) operation screen is displayed. Press [Fn1] to operate the defocus control, and then press it again to finish the operation.

2 Rotate the rear dial to set

- Press [MENU/SET] to return to the recording screen.

When setting the brightness (exposure)

- You can set the exposure compensation value in the range between -5 EV and $+5$ EV.
- Press ▲▼ to set the Exposure Bracket. (→142)

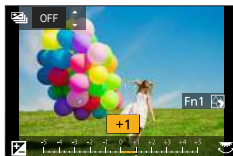

When setting the background defocusing

- Pressing [Q.MENU/↵] button will cancel the setting.



■ With touch screen operations

① Touch [☞]

② Touch the item you want to set

[☞]: Adjusting the picture effect

[☞]: Degree of defocusing

[☞]: Brightness (Displayed only when [Exposure Dial] is set to [OFF])

③ Drag the slide bar or exposure meter to set

- Press [MENU/SET] to return to the recording screen.



- Defocus control operation is not available in [Miniature Effect] (Creative Control Mode).



Recording motion pictures by setting the aperture/shutter speed/ISO sensitivity (Creative Video Mode)

Recording mode: 

The operation for changing the aperture value, shutter speed or ISO sensitivity is the same as the operation for setting the mode dial to [P], [A], [S] or [M] (except Programme Shift Mode).

1 Set mode dial to

2 Set the menu

MENU →  [Creative Video] → [Exposure Mode]

Settings: [P] / [A] / [S] / [M]





It is also possible to display the selection screen by touching the Recording mode icon in recording screen.





3 Press the motion picture button (or shutter button) to start recording

① Touch 

② Touch icon

	Zoom (When using an interchangeable lens supporting power zoom)		Exposure Compensation (When [Exposure Dial] (→49) is set to [OFF])
F	Aperture value	ISO	ISO sensitivity
SS	Shutter speed		[Sound Rec Level Adj.]

③ Drag the slide bar to set

	Changes the setting slowly
	Changes the setting quickly

Using touch icons allows silent operation while recording motion pictures.



4 Press the motion picture button (or shutter button) to stop recording



Recording motion pictures by setting the aperture/shutter speed/ISO sensitivity (Creative Video Mode)

- The ISO sensitivity can be set within the following range.
 - [AUTO], [200] to [6400] ([L.100] to [6400] when [Extended ISO] is set to [ON])

■ Setting the upper limit value of ISO sensitivity when [Sensitivity] is set to [AUTO]

MENU →  [Motion Picture] → [ISO Auto Upper Limit (Video)]

Settings: [AUTO] / [400] / [800] / [1600] / [3200] / [6400]



Recording motion pictures by setting the aperture/shutter speed/ISO sensitivity (Creative Video Mode)

Pan or zoom while recording with the camera in a fixed position ([4K Live Cropping])

By cropping your motion picture down from the 4K angle of view to Full High Definition, you can record a motion picture that pans and zooms in/out while leaving the camera in a fixed position.



Pan



Zoom in

- Hold the camera firmly in place while recording.
- A motion picture will be recorded at [FHD/20M/25p] under [MP4].

1 Set mode dial to [M]

2 Set the menu

MENU → **M** [Creative Video] → [4K Live Cropping]

Settings: [40SEC] / [20SEC] / [OFF]

3 Set the crop start frame and press [MENU/SET] to set

Ⓐ Crop start frame

- When making settings for the first time, a crop start frame of size 1920×1080 is displayed. (After setting the crop start frame and end frame, the start frame and end frame that you set immediately before will be displayed.)
- The camera will remember the frame position and size even when the camera is turned off.

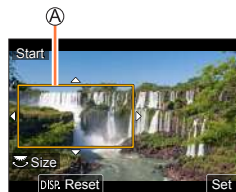

Operation	Touch operation	Description
▲▼◀▶	Touch	Moves the frame
	Pinch out / Pinch in	Enlarges/reduces the frame (The range of settings allowed is from 1920×1080 to 3840×2160.)
[DISP.]	[Reset]	Returns the position of the frame to the centre and its size to the default setting
[MENU/SET]	[Set]	Decides the position and size of the frame

Recording motion pictures by setting the aperture/shutter speed/ISO sensitivity (Creative Video Mode)

4 Repeat step 3, and then set the crop end frame**B** Crop end frame

- The setting of [AF Mode] switches to [👤] (Face Detection).
(The Eye Detection cannot be used.)

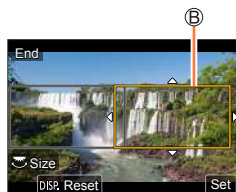
**5 Press the motion picture button (or shutter button) to start recording**

- C** Elapsed recording time
- D** Set operating time

- Immediately release the motion picture button (or shutter button) after pressing it.
- When the set operating time has elapsed, recording automatically ends. To end recording midway, press the motion picture button (or the shutter button) again.



When you want to zoom in/out, set different angles of view for the cropping start and end frames. For example, to zoom in, set a larger angle of view for the start frame and a smaller angle of view for the end frame.

■ Changing the position and size of a crop frame

Press [Fn2] button while the recording screen is displayed, and perform steps **3** and **4**.

■ To cancel [4K Live Cropping] recording

Set [OFF] in step **2**.

- The angle of view narrows.
- Brightness is measured and focus is adjusted in the crop start frame. When recording a motion picture, brightness is measured and focus is adjusted in the crop frame. To fix the focus position, set [Continuous AF] to [OFF], or set the focus mode to [MF].
- [Metering Mode] will be [☉] (Multi Metering).



Registering your own settings and recording

(Custom Mode)

Recording mode: 

Registering your own settings ([Cust.Set Mem.]

Up to 3 sets of current camera settings can be registered using [Cust.Set Mem.].

([C 1], [C 2], [C 3])

- Initial setting of the Programme AE Mode is registered as the custom settings initially.

Preparations

- Set in advance the recording mode and menu settings so that the camera can be in the state with the settings to be saved.

MENU →  **[Setup]** → **[Cust.Set Mem.]**
→ **Custom set where you want to register settings**

- The following menu items are not registered as custom settings.

[Custom] menu	[Setup] menu	[Playback] menu
<ul style="list-style-type: none"> • [Menu Guide] • Data registered with [Face Recog.] • The [Profile Setup] setting 	<ul style="list-style-type: none"> • All menus 	<ul style="list-style-type: none"> • [Rotate Disp.] • [Picture Sort] • [Delete Confirmation]



Registering your own settings and recording (Custom Mode)

Recording using registered custom set

1 Set mode dial to [C]

- The custom set you used last time will be called up.

■ To change a custom set

- Set mode dial to [C]
- Press [MENU/SET] to bring up the menu
- Press ▲▼ to select the custom set you want to use, and press [MENU/SET]

- The settings are switched to those settings you selected for the custom set.



It is also possible to display the selection screen by touching the Recording mode icon in recording screen.



■ Changing the registered content

Even if the menu settings are changed temporarily when the mode dial has been set to [C], the currently registered settings will remain unchanged. To change the currently registered settings, overwrite the registered data using [Cust.Set Mem.] on the [Setup] menu.



Taking pictures with Auto Focus

1 Set the focus mode lever to [AFS/AFF] or [AFC]

- The Focus Mode will be set. (→96)

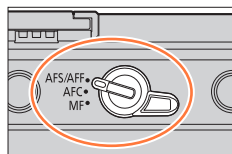

2 Press [] button (◀)

3 Press ◀▶ to select AF Mode and then press [MENU/SET]

- Switching [AF Mode] (→97)

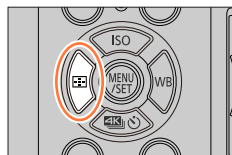

4 Press the shutter button halfway

- Ⓐ Focus display
(When focus is aligned: illuminated
When focus is not aligned: flashing)
- Ⓑ AF area
(When focus is aligned: green)

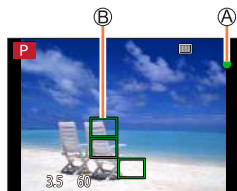

- Two “beep” sounds are heard and Auto Focus is activated.
- When you take a picture in a dark location, [LOW] is displayed for the focus display and it may take longer to adjust focus than usual.
- If the camera detects stars in the night sky after displaying [LOW], Starlight AF will be activated. When focus is achieved, the focus indication [STAR] and AF areas in focus are displayed. (Starlight AF cannot perform detection on the edges of the screen.)



Subjects/environments which may make focusing difficult:

- Fast-moving or extremely bright objects, or objects with no colour contrast.
- Taking pictures through glass or near objects emitting light.
- In the dark, or with significant jitter.
- When too close to object or when taking pictures of both distant and close objects together in the same picture.

- If you zoom in/out after focusing on a subject, the focus may lose its accuracy. In that case, re-adjust the focus.

Set the Focus Mode (AFS, AFF, AFC)

Recording mode:

The method for achieving focus when the shutter button is pressed halfway is set.

1 Set the focus mode lever to [AFS/AFF] or [AFC]

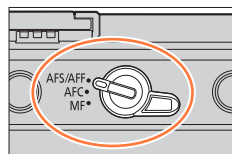

Settings		The movement of the subject and the scene (recommended)	Description
[AFS/AFF]	[AFS]	Subject is still (Scenery, anniversary photograph, etc.)	"AFS" is an abbreviation of "Auto Focus Single". Focus is set automatically when the shutter button is pressed halfway. Focus will be fixed while it is pressed halfway.
	[AFF]	Movement cannot be predicted (Children, pets, etc.)	"AFF" is an abbreviation of "Auto Focus Flexible". In this mode, focusing is performed automatically when the shutter button is pressed halfway. If the subject moves while the shutter button is pressed halfway, the focus is corrected to match the movement automatically.
		You can switch the setting with [AFS/AFF] in the [Rec]/[Motion Picture] menu.	
[AFC]		Subject is moving (Sport, trains, etc.)	"AFC" is an abbreviation of "Auto Focus Continuous". In this mode, while the shutter button is pressed halfway, focusing is constantly performed to match the movement of the subject.



When recording using [AFF], [AFC]

- When the subject is moving, the focusing is performed by predicting the subject position at the time of recording. (Movement prediction)
- Focusing may take time if the zoom is suddenly changed from max. Wide to max. Tele, or if you suddenly move closer to a subject from a greater distance.
- Press the shutter button halfway again when it is difficult to focus on the subject.
- While the shutter button pressed halfway, shake may be seen on the screen.



Taking pictures with Auto Focus

- [AFF] or [AFC] operates as [AFS] in the following cases:
 - Creative Video Mode
 - When recording with [4K Burst(S/S)] ([4K Burst(S/S)]) of the 4K Photo function.
 - When the lighting is low.
- It is fixed to [AFS] when Panorama Shot Mode is set.
- When the interchangeable lens (H-H020A) is used, [AFF] and [AFC] cannot be set.
- [AFF] is not available when recording 4K photos. Continuous AF works during recording.
- This setting cannot be used when recording using [Post Focus].

Switching [AF Mode]

Recording mode: **P** **A** **S** **M**

This allows the focusing method that suits the positions and number of the subjects to be selected.

1 Press [**+**] button (◀)

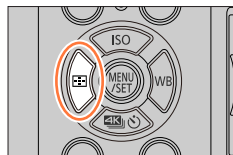

2 Press ◀▶ to select Auto Focus mode and press [MENU/SET]

Settings: [] (Face/Eye Detection) / [] (Tracking) / [] (49-area-focusing) / [] etc. (Custom Multi) / [] (1-area-focusing) / [] (Pinpoint-focusing)
(→98 - 102)

- In Intelligent Auto Mode and Intelligent Auto Plus Mode, [] or [] can be set.
- The [AF Mode] is fixed to [] in the following case:
 - When recording using [4K Live Cropping]
- Auto Focus is fixed to [] in the following cases:
 - When using the Digital Zoom
 - [Miniature Effect] (Creative Control Mode)
- [AF Mode] cannot be set in the following cases:
 - When recording using [Post Focus]
 - When [Pull Focus] in [Snap Movie] is set to [ON]

Taking pictures with Auto Focus

Taking front-on pictures of people  (Face/Eye Detection)

The camera automatically detects the faces and eyes of subjects. The camera adjusts the focus on the eye that is closer to the camera and the exposure using the face (when [Metering Mode] is set to  (Multi Metering)).

- The camera can detect up to 15 faces. The camera can detect only the eye of face to be focused on.
- When the camera recognised a face, the AF area and eye used for focusing are displayed.

 Eye used for focusing

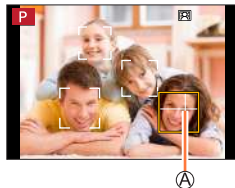

Yellow: When the shutter button is pressed halfway and the subject is focused, the frame turns green.

White: Displayed when more than one face is detected. Other faces that are the same distance away as faces within the yellow AF area are also focused.

**Changing the eye to be in focus****Touch the eye to be used for focusing**

- If you touch  or press [MENU/SET], the eye focus setting will be cancelled.



- Cannot set to  (Face/Eye Detection) in the following case:
 - [Clear Nightscape], [Cool Night Sky], [Warm Glowing Nightscape], [Artistic Nightscape], [Glittering Illuminations], [Handheld Night Shot], [Appetizing Food], [Cute Dessert] (Scene Guide Mode)
- The eye to be in focus cannot be changed when [4K Live Cropping] is set.
- If conditions prevent the face from being recognised, such as when the movement of the subject is too rapid, the AF Mode setting switches to  (49-area-focusing).

Automatically locking the focus on a moving subject (tracking)

With cursor button operations

Align the AF Tracking area with the subject and press the shutter button halfway

 AF Tracking area

When the subject is recognised, the AF tracking area turns green. When you release the shutter button, the AF tracking area turns yellow and the subject is automatically kept in focus.

- To release AF Tracking → Press [MENU/SET].

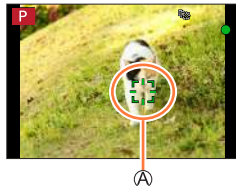





With touch screen operations

Touch the subject

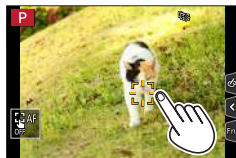
Perform these operations with the touch shutter function released. The AF Tracking area turns yellow while the subject is locked.

- To release AF Tracking → Touch .



- If AF Lock fails, a red frame flashes for a while and then turns off.
- When you set [Metering Mode] to  (Multi Metering), the camera adjusts the exposure using a locked subject. (→196)
- Under certain recording conditions, such as when the subject is small or dark, AF Tracking may not operate correctly. When AF Tracking does not work, focus will be on  (1-area-focusing).
- This function is not available in the following case:
 - When using [Time Lapse Shot]
- In the following cases,  performs the operation of  (1-area-focusing).
 - [Glistening Water], [Glittering Illuminations], [Soft Image of a Flower], [Monochrome] (Scene Guide Mode)
 - [Sepia], [Monochrome], [Dynamic Monochrome], [Rough Monochrome], [Silky Monochrome], [Soft Focus], [Star Filter], [Sunshine] (Creative Control Mode)
 - [Monochrome], [L.Monochrome], [L.Monochrome D] ([Photo Style])



Taking pictures with Auto Focus

Subject not centred in picture  (49-area-focusing)

Focuses on the subject in the wide range area (up to 49-area-focusing) on the recording screen.





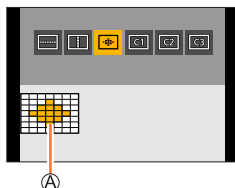

**Setting the shape of an AF area** , etc. (Custom Multi)

You can set the preferred shape of an AF area by selecting 49 points in the AF area, based on the subject.

- 1 Press  button (◀)
- 2 Select a Custom Multi icon (, etc.), and press ▲
- 3 Use ◀▶ to select the setting item

Ⓐ Current AF area shape

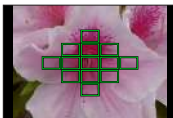

 (Horizontal Pattern)	Ideal shape for panning, etc.	
 (Vertical Pattern)	Ideal shape for recording structures, etc.	
 (Central Pattern)	Ideal shape for focusing around the centre.	
 (Custom)	You can set a custom registration shape.	

- 4 Press ▼
 - The AF area setting screen appears.

5 Select the AF area

Ⓑ Selected AF area

When selecting [] / [] / []

① Change the shape of an AF area

Operation	Touch operation	Description
▲▼◀▶	Touch	Moves position
	Pinch out / Pinch in	Changes the size (3 stages)
[DISP.]	[Reset]	Resets the AF area back to the centre. • If you press the button again, the frame size will be reset to the initial setting.

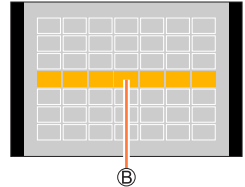

② Press [MENU/SET]

When selecting [C1] / [C2] / [C3]

① Change the shape of an AF area

With cursor button operations

Use ▲▼◀▶ to select AF area and press [MENU/SET] to set (repeat)

- If you press [MENU/SET] again, the setting will be cancelled.
- To cancel all the settings, press the [DISP.] button.

With touch screen operations

Touch the parts you want to set as AF areas

- If you touch one of the selected AF areas, the selection of the area will be cancelled.

② Press [Fn1] button

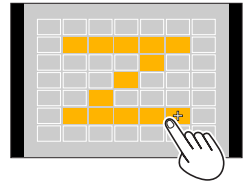

■ Registering the set AF area in [C1], [C2] and [C3] (Custom)

① Press ▲ on the screen of step 3

② Use ▲▼ to select the registration target icon and press [MENU/SET]

- The settings adjusted in [], [] or [] will be restored to the default settings when the camera is turned off.

Determined position for focus  (1-area-focusing) /** (Pinpoint-focusing)**** (1-area-focusing)**



Focuses on AF area in centre of picture. (Recommended when focus is difficult to align)



When the subject is not in the centre of the composition in [, you can bring the subject into the AF area, fix the focus and exposure by pressing the shutter button halfway, move the camera to the composition you want with the shutter button pressed halfway, and then take the picture. (Only when the focus mode is set to [AFS].)

 (Pinpoint-focusing)

Enables more precise focusing on a smaller point than [, (1-area-focusing). When you press the shutter button halfway, an enlarged display of the focus position appears.

- If [, (Pinpoint-focusing) is selected while recording motion pictures or 4K photos, the setting is changed to [, (1-area-focusing).
- Cannot set to [, (Pinpoint-focusing) in the following case:
 - When the focus mode is set to [AF] or [AFC]



Changing the position and size of the AF area

Recording mode: **PAS**

When [], [], [], or [] in Auto Focus Mode is selected, you can change the position and size of the AF area. With [], you can set the lock-on position.

- Perform these operations with the touch shutter function released.
- You can also display the AF area setting screen by touching the recording screen.

MENU → **[Custom]** → **[Operation]** → **[Touch Settings]** → **[Touch AF]**
→ **[AF]**

- You can use the [Custom] ([Focus / Release Shutter]) menu to set the display method for the AF area according to your preference. (→207)

- When you set [Metering Mode] to [] (spot-focusing), the metering target will move along with the AF area.
- The position and size of the AF area cannot be changed in the Digital Zoom range.

■ When selecting [] / [] / []

- ① Press [] button (◀)
- ② Select [], [] or [] and press ▼
 - The AF area setting screen appears.



③ To change the AF area

Operation	Touch operation	Description
	Touch	To move the position of the AF area.
	Pinch out / Pinch in	Enlarges/reduces the AF area in small steps.*
	—	Enlarges/reduces the AF area in large steps.*
[DISP.]	[Reset]	Resets the AF area back to the centre. • If you press the button again, the frame size will be reset to the initial setting.

* Not available when [] is selected.

- ④ Press **[MENU/SET]**
 - AF area with the same function as [] is displayed in the touched position, when the [] is selected. Setting of the AF area is cleared when **[MENU/SET]** is pressed or [] is touched.

Taking pictures with Auto Focus

■ When selecting [AF]

You can set the focus position by selecting an AF area group. The AF area, which is configured with 49 points, is divided into groups consisting of 9 points each (6 points or 4 points for the groups located at the edges of the screen).

- ① Press [AF] button (◀)
- ② Select [AF] and press ▼
 - The AF area setting screen appears.
- ③ Press ▲▼◀▶ to select an AF area group
- ④ Press [MENU/SET]
 - Setting of the AF area is cleared when [MENU/SET] is pressed or [AF] is touched.

Examples of group

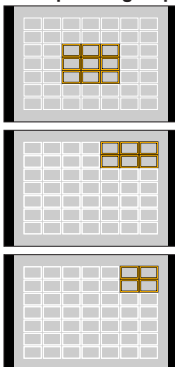

Taking pictures with Auto Focus

■ When selecting [+]

You can enlarge the screen to perform more precise settings of the focus position.

- You cannot set the focus position at the edges of the screen.

- ① Press [+] button (◀)
- ② Select [+] and press ▼
- ③ Use ▲▼◀▶ to set the focus position and press [MENU/SET]
 - The enlarged assist screen will appear for setting the focus position.

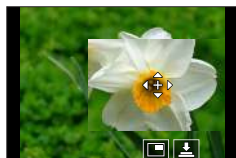

- ④ Move [+] to the focus position

Operation	Touch operation	Description
▲▼◀▶	Touch	Moves [+].
	Pinch out / Pinch in	Enlarges/reduces the screen in small steps.
	—	Enlarges/reduces the screen in large steps.
		Switches the enlarged display. (windowed/full screen)
[DISP.]	[Reset]	Returns to the screen of step ③.



- The image of a part of the screen can be enlarged or reduced approximately 3 to 6 times. The image of the entire screen can be enlarged or reduced approximately 3 to 10 times.
- It is also possible to record a picture by touching [+].

- ⑤ Press [MENU/SET]



Setting the AF area position with the touch pad

Recording mode:

You can move the AF area displayed on the viewfinder by touching the monitor.

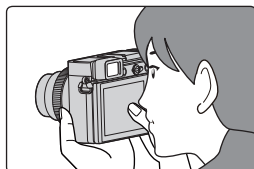

MENU → **[Custom]** → **[Operation]** → **[Touch Settings]** → **[Touch Pad AF]**

[EXACT]	Moves the AF area of the viewfinder by touching a desired position on the touch pad.	
[OFFSET]	Moves the AF area of the viewfinder according to the distance you drag the touch pad.	
[OFF]	—	—

- Press the shutter button halfway to determine the focus position. If you press the [DISP.] button before determining the focus position, the focus position returns to the centre.
- To cancel the settings for the AF area when the Auto Focus Mode is set to [] (Face/Eye Detection), [] (tracking), or [] (49-area-focusing), press [MENU/SET].

- The Touch Shutter function is disabled when using [Touch Pad AF].
- The [Touch Pad AF] does not function in the following cases:
 - When recording using [4K Live Cropping]
 - When [Pull Focus] in [Snap Movie] is set to [ON]

Optimising the focus and brightness for a touched position

Recording mode:

MENU → **[Custom]** → **[Operation]** → **[Touch Settings]** → **[Touch AF]**
→ **[AF+AE]**

1 Touch the subject you want to optimise the brightness for

- The AF area setting screen appears. (→103)
- The brightness optimisation position is displayed on the centre of the AF area. The position follows the movement of the AF area.
- [Metering Mode] is set to , which is used exclusively for the [Touch AE].



2 Touch [Set]

- The AF area with the same function as is displayed on the touched position.
- If you touch (touch when is set), the setting of [AF+AE] is cancelled.



When the background has become too bright, etc., the brightness contrast with the background can be adjusted by compensating the exposure.



- When recording with the Touch Shutter, the focus and brightness are optimised for the touched position before recording takes place.
- At the edge of the screen, the metering may be affected by the brightness around the touched location.
- The [AF+AE] does not function in the following cases:
 - When using the Digital Zoom
 - When recording using [4K Live Cropping]

Taking pictures with Manual Focus

Recording mode: 

Manual Focus is convenient when you want to lock the focus to take pictures or when it is difficult to adjust focus using Auto Focus.

1 Set the focus mode lever to [MF]

2 Press button (◀)

3 Press ▲▼◀▶ to adjust the focus position, and press [MENU/SET]

- The screen changes to the assist screen and an enlarged display appears. (MF Assist)
You can move the enlarged part by dragging the screen.
- You can also enlarge the area by performing one of the following operations:
 - Rotating the focus ring
 - Moving the focus lever
 - Pinching out or touching the screen twice
- To return the focus position to the centre, press [DISP.] button.

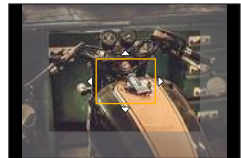
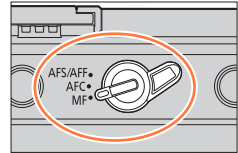

4 Adjust the focus

The operations used to focus differ depending on the lens.

When using an interchangeable lens (H-FS12032) with no focus ring

Press ▶ : Focuses on nearby subject

Press ◀ : Focuses on distant subject

 Slide bar

- These operations are possible only on the focus adjustment screen.
- Pressing and holding ◀▶ will increase the focus speed.
- Focus can also be adjusted by dragging the slide bar.

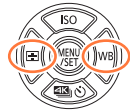
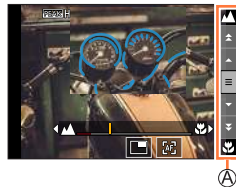

Taking pictures with Manual Focus

When using an interchangeable lens (H-FS12060/H-FS1442A/H-FS35100/H-H020A/H-FS14140) with a focus ring

Rotate to **A** side: Focuses on nearby subject

Rotate to **B** side: Focuses on distant subject

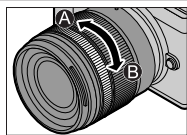

When using the interchangeable lens having a focus lever

Move to **C** side: Focuses on nearby subject

Move to **D** side: Focuses on distant subject

• The focusing speed varies depending on how far you move the focus lever.

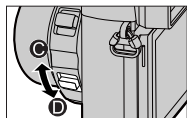





A MF Assist (Enlarged screen)

B MF Guide (→218)

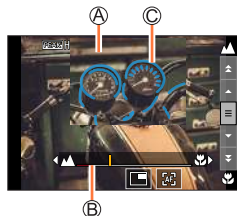
C Peaking

• Colour is added to the portions of the image that are in focus. (Peaking) (→215)



Operation	Touch operation	Description
▲▼◀▶*1	Drag	Moves the enlarged area.
	Pinch out / Pinch in	Enlarges/reduces the screen in small steps.
	—	Enlarges/reduces the screen in large steps.
 *2	 *2	Switches the enlarged display. (windowed/full screen)*3
[DISP.]*1	[Reset]*1	Resets the area to be enlarged back to the centre.

*1 When using an interchangeable lens with no focus ring, you can perform these operations after pressing ▼ to display the screen that lets you set the area to be enlarged.

*2 Cannot be set when using Intelligent Auto Mode.

*3 The image of a part of the screen can be enlarged or reduced approximately 3 to 6 times. The image of the entire screen can be enlarged or reduced approximately 3 to 20 times.

5 Press the shutter button halfway

- The recording screen will be displayed.
- The same operation can be performed by pressing [MENU/SET].
- If you have enlarged the picture by rotating the focus ring or moving the focus lever, the assist screen will close approximately 10 seconds after the operation.

- MF Assist and MF Guide may not display depending on the lens used. You can, however, display MF Assist by directly operating the camera using the touch screen or a button.
- When [Focus Switching for Vert / Hor] in the [Custom] ([Focus / Release Shutter]) menu is set, you can set a position of the enlarged area of MF Assist for each direction of the camera.
- The focus distance reference mark (A) is a mark used to measure the focus distance.
Use this when taking pictures with Manual Focus or taking close-up pictures.

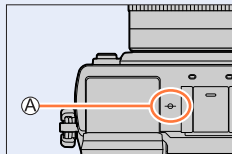

Quickly adjusting the focus using Auto Focus

In Manual Focus, the focus can be set on the subject through Auto Focus.

1 Touch [AF-ON]

- Auto Focus is activated at the centre of the frame.
- Auto Focus also works with the following operations.
 - Pressing the [AF/AE LOCK] button to which [AF-ON] is assigned (→111)
 - Pressing the function button to which [AF-ON] is assigned (→60)
 - Dragging the monitor and releasing your finger at the position you want to focus on
- This function cannot be used when [4K Live Cropping] is set.

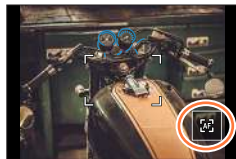

Taking pictures by locking the focus and/or exposure

(AF/AE Lock)

Recording mode:   **P** **A** **S** **M**   **SCN** 

You can use the AF/AE Lock function to fix the focus and exposure in advance and change the composition of the picture when recording. This function is convenient when you want to focus on the edge of the screen or when your subject is back-lit.

- 1** Point the camera at the subject
- 2** Lock the focus and/or exposure while you press and hold **[AF/AE LOCK]** button
 - When you release **[AF/AE LOCK]** button, the focus and/or exposure lock is cancelled.
- 3** While you press and hold **[AF/AE LOCK]** button, move the camera to compose the picture you want to take and fully press the shutter button

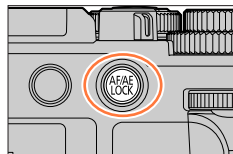

■ Setting the function of **[AF/AE LOCK]**

[MENU] →  **[Custom]** →  **[Focus / Release Shutter]** → **[AF/AE Lock]**

[AE LOCK]	Locks exposure only. • [AEL] is displayed when the correct exposure is achieved.
[AF LOCK]	Locks focus only. • [AFL] is displayed when the subject comes into focus.
[AF/AE LOCK]	Locks focus and exposure. • [AFL] and [AEL] are displayed when the subject is in focus and the correct exposure is achieved.
[AF-ON]	Auto Focus is activated.

- AE Lock is disabled in Manual Exposure Mode.
- AF Lock is disabled during Manual Focus.
- Programme Shift can be set even when AE is locked.



Taking pictures with Exposure Compensation

Recording mode: P A S M

Corrects the exposure when there is a backlight or when the subject is too dark or too bright.

1 Rotate the Exposure Compensation dial to compensate the exposure

- You can set the exposure compensation value in the range between -3 EV and $+3$ EV.

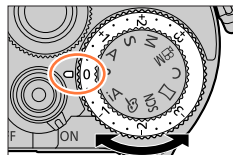

Under-exposed



Adjust the exposure to the [+] direction

Optimum exposure



Adjust the exposure to the [-] direction

Over-exposed



■ Extending the Exposure Compensation value (Compensating the exposure with the rear dial)

Preparation

Disable the Exposure Compensation dial

MENU → [Custom] → [Operation] → [Dial Set.] → [Exposure Dial] → [OFF]

- Press the rear dial to switch to Exposure Compensation operation
- Rotate the rear dial to compensate the exposure

- (A) Exposure Bracket
- (B) Exposure Compensation
- (C) [Flash Adjust.]

- You can set the Exposure Compensation value in the range between -5 EV and $+5$ EV.
- Press to set the Exposure Bracket. (→142)
- You can set [Flash Adjust.] (→167) by rotating the front dial. (Press [DISP.] button to switch the operations of rear dial and front dial.)

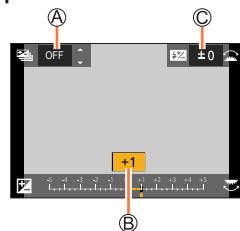

③ Press the rear dial to set

- When [Exposure Comp.] in [Dial Set.] is set to (front dial) or (rear dial), you can compensate the exposure simply by rotating the set dial in the same manner as Exposure Compensation dial operation. (→49)

Taking pictures with Exposure Compensation

- In Manual Exposure Mode, you can correct the exposure only when the ISO sensitivity is set to [AUTO].
- Settings can be made within a range of -3 EV to $+3$ EV while recording motion pictures, recording 4K photos, or recording in [Post Focus].
- When [Auto Exposure Comp.] of [Flash] in the [Rec] menu is set to [ON], the flash output is also automatically adjusted based on the exposure compensation value.
- Depending on the brightness, this may not be possible in some cases.
- When the Exposure Compensation value is out of the -3 EV to $+3$ EV range, the brightness of the recording screen will no longer change. You can apply the exposure compensation value by pressing the shutter button halfway or pressing the [AF/AE LOCK] button to lock exposure.
- The set Exposure Compensation value is stored even if the camera is turned off. (When [Exposure Comp. Reset] is set to [OFF])



Setting the ISO Sensitivity

Recording mode: **P** **A** **S** **M**

Set ISO sensitivity (sensitivity to lighting).

1 Press [ISO] button (▲)

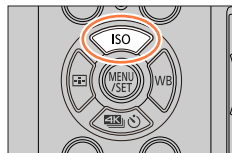

2 Select the ISO sensitivity by rotating the rear dial

Ⓐ ISO sensitivity

Ⓑ [ISO Auto Upper Limit Setting]

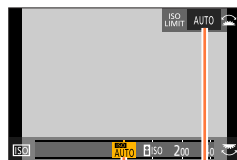

AUTO	ISO sensitivity is automatically set in a range up to 3200* ¹ depending on the brightness of a subject.
ISO (Intelligent ISO)	ISO sensitivity is automatically set in a range up to 3200* ¹ depending on the movement and brightness of a subject. • The shutter speed is not fixed when the shutter button is pressed halfway. It is continuously changing to match the movement of the subject until the shutter button is pressed fully.
[L. 100]*² / from [200] to [25600]	ISO sensitivity is fixed at the selected setting.

*¹ When [ISO Auto Upper Limit (Photo)] is set to [AUTO].

*² Only when [Extended ISO] is [ON].

3 Rotate the front dial to set the [ISO Auto Upper Limit Setting]

- It will work when the [Sensitivity] is set to [AUTO] or [ISO].
- You can switch the functions between the rear dial and the front dial by pressing [DISP.] button.

4 Press the rear dial to set

- You can also press the shutter button halfway to set.



Setting the ISO Sensitivity



Setting guide

ISO sensitivity	[200] ←→ [25600]
Location (recommended)	Bright (outdoors) Dark
Shutter speed	Slow Fast
Interference	Low High
Subject blur	High Low

- For details on the available flash range used when the ISO sensitivity is set to [AUTO], refer to (→161).
- Cannot select [ISO] in the following cases:
 - Shutter-Priority AE Mode
 - Manual Exposure Mode
- When [Multi Exp.] is set, the maximum setting is [3200].
- ISO sensitivity is set to [AUTO] (for motion pictures) while a motion picture is being recorded. You can use the following ISO sensitivity settings when recording in Creative Video Mode, when recording 4K photos, or when recording using [Post Focus].
 - [AUTO], [200] to [6400] ([L.100] to [6400] when [Extended ISO] is set to [ON])



Adjusting the White Balance

Recording mode: [A]

This item adjusts to the colour of white which is closest to what is seen by the eye in accordance with the light source.

1 Press [WB] button (▶)

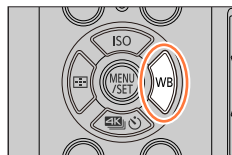

2 Rotate the rear or front dial to select the White Balance

[AWB]/ [AWBc]	Automatic adjustment in accordance with the light source. <ul style="list-style-type: none"> Under a light source (such as an incandescent light) that produces reddish pictures: <ul style="list-style-type: none"> [AWB] gives higher priority to what is seen by the eye and retains the reddish hue. [AWBc] gives higher priority to the original colours of the subject and reduces the reddish hue. When the picture is taken under a bright ambient light, the colours of the pictures are sometimes adjusted to similar colours as those of the [AWB] setting. Adjust the colours of the pictures to similar colours when [AWB] or [AWBc] is set under a light source that does not produce reddish pictures.
[☀]	Adjust to the colour under a clear sky.
[☁]	Adjust to the colour under a cloudy sky.
[🏠]	Adjust to the colour in the shade.
[💡]	Adjust to the colour under incandescent lights.
[⚡]	Adjust to the colour that is optimal for taking pictures using the flash.
[1]/[2]/ [3]/[4]	Use the White Balance value that was set manually. <ol style="list-style-type: none"> Press ▲ Point the camera at a white object such as a piece of paper, ensuring that it is inside the frame at the centre of the screen, and press the shutter button <ul style="list-style-type: none"> This will set the White Balance and return you to the recording screen. It may not be possible to set the correct White Balance if subjects are too bright or too dark.
[K]	You can set the White Balance using colour temperature. <ol style="list-style-type: none"> Press ▲ Use ▲▼ to select the colour temperature value and press [MENU/SET] <ul style="list-style-type: none"> You can set the colour temperature from [2500K] to [10000K].



* The [AWB] setting is applied while recording motion pictures, recording 4K photos, or recording in [Post Focus].

3 Press the rear dial to set

- You can also press the shutter button halfway to set.



Under fluorescent lighting, LED lighting fixtures, etc., the optimal White Balance will vary depending on the lighting type, so use [AWB], [AWBc], [⏏], [⏏], [⏏] or [⏏].

- The White Balance may not operate correctly if you take pictures using a flash and the subject is recorded outside of the effective flash range.
- In Scene Guide Mode, settings suitable for each scene are made.
- In Scene Guide Mode, changing the scene or recording mode will return White Balance settings (including the White Balance fine adjustment setting) back to [AWB].

■ Auto White Balance

When [AWB] (Automatic White Balance) is set, the colouring is adjusted in accordance with the light source. However, if the scene is too bright or too dark or if other extreme conditions apply, the pictures may appear reddish or bluish. The White Balance may not operate correctly if there is a multiple number of light sources. In that case, set the [White Balance] to settings other than [AWB] or [AWBc] to adjust the colouring.

: [AWB] operational range

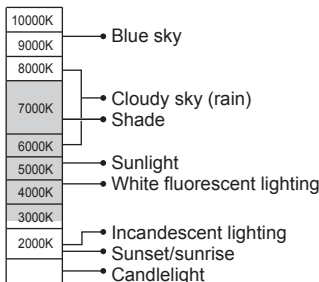

K=Kelvin Colour Temperature



Adjusting the White Balance

Performing White Balance fine adjustments

White Balance settings can be individually fine-tuned if colours still do not appear as anticipated.

1 In step 2 of “Adjusting the White Balance” (→116), select the White Balance and press ▼

2 Use ▲ ▼ ◀ ▶ to perform White Balance fine adjustments

- ◀: A (amber: orangish colours) ▶: B (blue: bluish colours)
- ▲: G (green: greenish colours) ▼: M (magenta: reddish colours)

- You can also make fine adjustments by touching the White Balance graph.
- Pressing [DISP.] button resets the position back to the centre.

3 Press [MENU/SET] to finalise the setting

- Press the shutter button halfway to return to the recording screen.

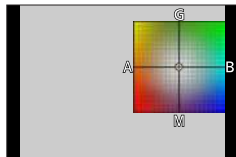

- When you perform fine adjustments of the White Balance toward the A (amber) or B (blue) side, the colour of the White Balance icon displayed on the screen will change to the fine-tuned colour.
- When you perform fine adjustments of the White Balance toward the G (green) or M (magenta) side, [+] (green) or [-] (magenta) will be displayed in the White Balance icon on the screen.

Adjusting the White Balance

Bracket recording using White Balance

Bracket settings are performed based on the fine adjustment values for White Balance, and three pictures with different colouring are automatically recorded when the shutter button is pressed once.

1 Perform fine adjustments of the White Balance in step 2 of “Performing White Balance fine adjustments” (→118) and rotate the rear dial to perform the Bracket setting

- You can also set the bracket by touching [◀▶]/[◀▶]/[◀▶]/[◀▶].

2 Press [MENU/SET] to finalise the setting

- Press the shutter button halfway to return to the recording screen.

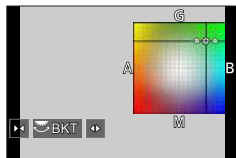

- You can also set the White Balance Bracket in [Bracket] in the [Rec] menu. (→141)
- This function is not available in the following cases:
 - Panorama Shot Mode
 - [Glistening Water], [Glittering Illuminations], [Handheld Night Shot], [Soft Image of a Flower] (Scene Guide Mode)
 - When using [Burst]
 - When recording 4K photos
 - When recording using [Post Focus]
 - When taking still pictures while a motion picture is being recorded
 - When [Quality] is set to [RAW:III], [RAW:II] or [RAW]
 - When [Multi Exp.] is set
 - When using [Time Lapse Shot]
 - When [Auto Shooting] of [Stop Motion Animation] is set to [ON]

Recording with the 4K Photo function and selecting pictures to save

Recording with the 4K Photo function

Recording mode:   **PAS** **M**   

You can take burst pictures of approximately 8 million pixels with a burst rate of 30 fps. You can select and save a frame from the burst file.

- To record pictures, use a UHS Speed Class 3 card.

1 Press button (▼)

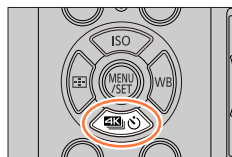



2 Press ◀▶ to select the 4K photo icon and press ▲

3 Press ◀▶ to select the recording method and press [MENU/SET]

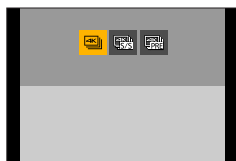
- The recording method can also be set using [4K PHOTO] → [Rec Method] in the [Rec] menu.







 [4K Burst]	For capturing the best shot of a fast-moving subject (e.g. sports, aeroplanes, trains) Audio recording: None
 [4K Burst(S/S)] "S/S" is an abbreviation of "Start/Stop".	For capturing unpredictable photo opportunities (e.g. plants, animals, children) Audio recording: Available*
 [4K Pre-Burst]	For recording as needed whenever a photo opportunity arises (e.g. the moment when a ball is thrown) Audio recording: None

* Audio is not played back when you perform playback with the camera.

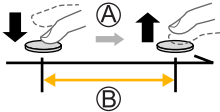
Recording with the 4K Photo function and selecting pictures to save

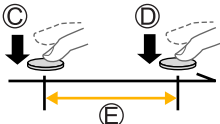
4 Recording with the 4K Photo function

 [4K Burst]	<ol style="list-style-type: none"> ① Press the shutter button halfway ② Press and hold the shutter button fully for as long as you want to perform recording <ul style="list-style-type: none"> • Recording will start approximately 0.5 seconds after you press the shutter button fully. Therefore, press the button fully slightly in advance. <p>Ⓐ Press and hold Ⓑ Recording is performed</p> 
 [4K Burst(S/S)] "S/S" is an abbreviation of "Start/Stop".	<ol style="list-style-type: none"> ① Press the shutter button fully <ul style="list-style-type: none"> • Recording will start. ② Press the shutter button fully again <ul style="list-style-type: none"> • Recording will stop. <p>Ⓒ Start (First) Ⓓ Stop (Second) Ⓔ Recording is performed</p>  <p> When you press the [Fn1] button while recording, you can add a marker. (Up to 40 markers for each recording.) When selecting and saving pictures from a 4K burst file, you can skip to the positions where you added markers.</p>

Recording with the 4K Photo function and selecting pictures to save



[4K Pre-Burst]

① Press the shutter button fully

- The camera adjusts the focus continuously when using Auto Focus. Except when in Manual Exposure Mode, it also adjusts the exposure continuously.
- Images may not be displayed as smoothly as when recording with the normal recording screen.

Ⓕ Approximately 1 second

Ⓖ Recording is performed

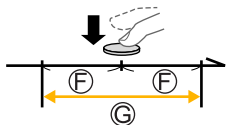

In situations where you want to lock focus and exposure, such as when the subject is not at the centre, use [AF/AE LOCK]. (→111)

- Burst pictures are saved as a single 4K burst file in the MP4 format.
- When [Auto Review] is enabled, the picture selection screen will be displayed automatically. To continue recording, press the shutter button halfway to display the recording screen.
- For information on how to select and save pictures from 4K burst files, refer to (→124).



Recording with the 4K Photo function and selecting pictures to save

■ Setting Pre-Burst Recording ([4K Burst]/[4K Burst(S/S)])

The camera starts recording approximately 1 second before the shutter button is pressed fully, so you will not miss a photo opportunity.

MENU →  [Rec] → [4K PHOTO] → [Pre-Burst Recording]

Settings: [ON] / [OFF]

- When this function is enabled, [PRE] is displayed on the recording screen.
- Auto Focus operation settings and menus that cannot be set while this function is in use are the same as those during [4K Pre-Burst] operation.

■ Setting Loop Recording ([4K Burst(S/S)])

You can perform recording while deleting the oldest recorded data, allowing you to keep on recording while waiting for a photo opportunity without replacing the card.

- Once you start recording, the 4K burst file will be recorded and divided approximately every 2 minutes.
- Approximately the last 10 minutes (up to approximately 12 minutes) will be saved. The preceding part will be deleted.

MENU →  [Rec] → [4K PHOTO] → [Loop Recording(4K PHOTO)]

Settings: [ON] / [OFF]



- We recommend that you use a sufficiently charged battery or an AC adaptor (optional) and DC coupler (optional).
- Up to 12 hours of continuous recording is possible.
- When this function is enabled, [L] is displayed on the recording screen.
- [Loop Recording(4K PHOTO)] is not possible when there is insufficient free space on the card.

■ To cancel the 4K Photo functions

In step 2, select [□] ([Single]) or [] ([OFF]).



Battery drainage and camera temperature

- If the surrounding temperature is high or 4K photos are recorded continuously, [] may be displayed and recording may be stopped halfway through. Wait until the camera cools down.
- When [] ([4K Pre-Burst]) or [Pre-Burst Recording] is set, the battery drains faster and the camera temperature rises.
Select [] ([4K Pre-Burst]) or [Pre-Burst Recording] only when recording.

Recording with the 4K Photo function and selecting pictures to save

Selecting pictures from 4K burst file and saving

1 Select a picture with the [▲] on the playback screen, and press ▲

- The same operation can be performed by touching [▲].
- In the case of recording with [4K] ([4K Pre-Burst]), proceed to the step 3.



2 Drag the slide bar to perform rough scene selection

- For information on how to operate the slide view screen, refer to (→125).
- If you touch [Fn] (or press the [Fn1] button), you can choose a scene in the 4K burst playback screen. (→126)

Slide view screen

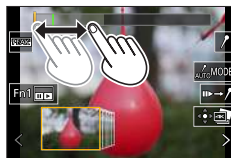

3 Drag to select the frame you want to save as a picture

- The same operation can be performed using ◀▶.



4 Touch [▶] to save the picture

- The selected picture will be saved as a new picture in the JPEG format separate from the 4K burst file.
- The picture will be saved with recording information (Exif information), including its shutter speed, aperture and ISO sensitivity information.



If you use [4K PHOTO Bulk Saving] in the [Playback] menu, you can bulk save 5 seconds' worth of 4K recording. (→242)



Recording with the 4K Photo function and selecting pictures to save

<Slide view screen>

Ⓐ Position of the displayed frame

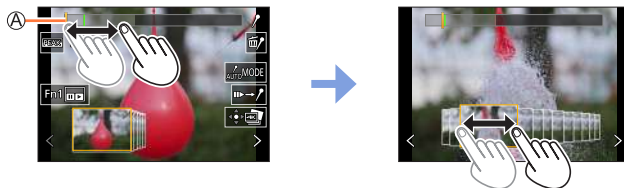

Operation	Touch operation	Description
—	Touch / Drag	Selects the scenes to be displayed • Scenes preceding and following the selected frame will be displayed in slide view.
	Drag	Selects the frame • To switch the slide view, select the frame at either end and touch [<] or [>].
Press and hold	Touch and hold	Continuously scrolls the scene or frame-by-frame backward or forward.
	Pinch out / Pinch in	Enlarges/reduces the display
	—	Selects a frame while maintaining the enlarged display (during enlarged display)
	Drag	Moves the enlarged area (during enlarged display)
—		Switches a marker to be displayed (→128)
—		Switches to marker operation (→127)
[Fn1]		Displays the 4K burst playback screen
—		Adds/deletes a marker
—		In-focus portions are highlighted with colour. ([Peaking]) • Switches in order of [PEAKS OFF] → [PEAKS L] ([LOW]) → [PEAKS H] ([HIGH]).
[MENU/SET]		Saves the picture

Recording with the 4K Photo function and selecting pictures to save

<4K burst playback screen>



During pause



During continuous playback

Operation	Touch operation	Description
—	Touch / Drag	Selects the scenes to be displayed (while paused)
▲	Play / Pause	Continuous playback / Pause (during continuous playback)
▼	Fast Rewind / Pause	Continuous rewind / Pause (during continuous rewind)
▶	Fast Forward / Single-frame forward	Fast forward playback / Single-frame forward (while paused)
◀	Fast rewind playback / Single-frame rewind	Fast rewind playback / Single-frame rewind (while paused)
	Pinch out / Pinch in	Enlarges/reduces the display (while paused)
	—	Selects a frame while maintaining the enlarged display (during enlarged display)
▲▼◀▶	Drag	Moves the enlarged area (during enlarged display)
—	AUTO MODE	Switches a marker to be displayed (→128)
—	Marker	Switches to marker operation (→127)
[Fn1]	Slide View	Displays the slide view screen (while paused)
—	Add/Remove Marker	Adds/deletes a marker
—	PEAK	In-focus portions are highlighted with colour. ([Peaking]) • Switches in order of [PEAK OFF] → [PEAK L] ([LOW]) → [PEAK H] ([HIGH]).
[MENU/SET]	Save	Saves the picture (while paused)

- You can also zoom in by quickly touching the touch screen twice. (If the display was enlarged, it returns to the same magnification ratio.)

Recording with the 4K Photo function and selecting pictures to save

■ Selecting and saving pictures on the TV screen

- Set [HDMI Mode (Play)] to [AUTO] or [4K/25p]. When connecting to a TV that does not support 4K motion picture, select [AUTO].
- If you connect the camera to a TV and display 4K burst files on the TV, they will be displayed only on the 4K burst playback screen.
- Even if you insert the SD card to a 4K-compatible TV with an SD card slot, you cannot play back 4K burst files recorded with [Aspect Ratio] set to an option other than [16:9]. (As of February 2018)
- Depending on the TV to be connected, 4K burst files may not be played back correctly.

Marker

When selecting and saving pictures from a 4K burst file, you can select pictures easily by skipping between marked positions.

■ Skips to the marked positions

When [⏮→↶] is touched on the slide view screen or 4K burst playback screen, the marker operation screen appears and you can skip to the marked positions. Touch [↷→⏭] to return to the original operation.

Operation	Touch operation	Description
◀ / ▶	⏮ / ⏭	Moves to the previous/next marker.

Two types of markers are available.

White marker: This is manually set during recording or playback.

Green marker: This is automatically set by the camera during recording. (Auto Marking function)

Ⓐ Manually set marker (white)

Ⓑ Marker set using the Auto Marking function (green)

Marker operation screen

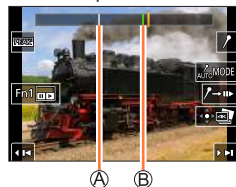

Ⓐ Ⓑ

Recording with the 4K Photo function and selecting pictures to save

**Auto Marking function**

The camera automatically sets markers on scenes in which a face or the movement of a subject is detected.

(Example: At the scene when a vehicle passes by, a balloon bursts, or a person turns around)

- Up to 10 markers are displayed for each file.
- In the following cases, markers may not be set by the Auto Marking function depending on the recording conditions and the status of subjects.
 - The camera is moving because of panning or jitter
 - The movement of a subject is slow/small, or the subject is small
 - A face is not facing front

Switches a marker to be displayed

Touch  on the slide view screen, 4K burst playback screen, or marker operation screen.

[Auto]	Displays a marker on a scene in which a face or the movement of a subject is detected.
[Face Priority]	Displays a marker with preference given to a scene in which a face is detected.
[Motion Priority]	Displays a marker with preference given to a scene in which the movement of a subject is detected.
[Off]	Displays manually set markers only.

- You cannot delete markers set by the Auto Marking function.
- The markers set by the Auto Marking function may not be displayed correctly if you split the 4K burst file on a device other than this camera and then play it back on the camera.
- In the following case, markers set by the Auto Marking function are not displayed.
 - 4K burst files recorded with [4K Pre-Burst]



Recording with the 4K Photo function and selecting pictures to save

Notes on the 4K Photo function

■ To change the aspect ratio

Selecting [Aspect Ratio] in the [Rec] menu allows you to change the aspect ratio for 4K photos.

■ To record the subject with reduced blur

You can reduce the blur of the subject by setting a faster shutter speed.

① Set mode dial to [S]

② Set the shutter speed by rotating the rear or front dial

- Approximate shutter speed for outdoor recording in fine weather conditions: 1/1000 seconds or faster.
- If you increase the shutter speed, the ISO sensitivity becomes higher, which may increase the noise on the screen.

■ Preventing camera shake when you are recording pictures

When you perform [Light Composition] or [Sequence Composition], we recommend using a tripod and taking pictures remotely by connecting the camera to a smartphone to prevent camera shake. (→265)

■ Shutter sound for 4K photo recording

- When using [] ([4K Burst]) or [] ([4K Pre-Burst]), you can change the electronic shutter sound settings in [Shutter Vol.] and [Shutter Tone]. (→225)
- When recording with [] ([4K Burst(S/S)]), you can set the start/stop tone volume in [Beep Volume].
- You can perform high speed burst recording quietly using the 4K Photo function in combination with [Silent Mode]. (→201)

■ Scenes not suitable for the 4K Photo function

Recording indoors

When recording under fluorescent lighting or LED lighting fixtures, etc., the colours and brightness may change or horizontal striping may appear on the screen. The striping may be reduced by setting a slower shutter speed. (→205)

Fast-moving subjects

Subjects moving fast may appear distorted when recorded.

Recording with the 4K Photo function and selecting pictures to save

■ The camera's setup for the 4K Photo function





The camera's setup is automatically optimised for 4K photo recording.

- The following settings are fixed.

[Picture Size]	[4K] (8M)	
	[4:3]: 3328×2496 [16:9]: 3840×2160	[3:2]: 3504×2336 [1:1]: 2880×2880
[Quality]	[	
[Shutter Type]	[ESHTR]	
[Rec Format]*	[MP4]	
[Rec Quality]*	[4K/100M/30p]	
[Continuous AF]*	[ON]	

*Settings in the [Motion Picture] menu are not applied to 4K burst files recorded with the 4K Photo function.



- The following limitations apply to the recording functions indicated below.

	 ([4K Burst])/  ([4K Burst(S/S)])	 ([4K Pre-Burst])
Programme Shift	Disabled	
Exposure compensation	-3 EV to +3 EV	
Shutter speed	1/30 to 1/16000	
[Min. Shtr Speed]	1/1000 to 1/30	
Focus mode ([AFF])	Disabled	
[AF Mode] ([])	Disabled	
[MF Assist]	○	Disabled
White Balance ([])	Disabled	
ISO sensitivity	[AUTO], [200] to [6400] ([L. 100] to [6400] when [Extended ISO] is set to [ON])	
Flash	Disabled	
Bracket recording	Disabled	

- The following menu items are disabled:

[Intelligent Auto]	[iHandheld Night Shot], [iHDR]
[Creative Control]	[Simultaneous Record w/o Filter]
[Rec]	[Picture Size], [Quality], [AFS/AFF], [Color Space], [Flash], [Long Shtr NR], [Shading Comp.], [Ex. Tele Conv.], [Shutter Type], [Shutter Delay], [Bracket], [HDR]
[Custom]	[Rec Area], [Face Recog.], [Profile Setup]
[Setup]	[Economy] (Only [] ([4K Pre-Burst]))

Recording with the 4K Photo function and selecting pictures to save

- Motion picture file will be recorded and played back in separate files in the following cases. (You can continue recording without interruption.)
 - When using an SDHC memory card: If the file size exceeds 4 GB
 - When using an SDXC memory card: If the continuous recording time exceeds 3 hours and 4 minutes or if the file size exceeds 96 GB
- When recording, the angle of view becomes narrower.
- The following changes occur when recording 4K photos:
 - [Destination] in [Travel Date] cannot be recorded.
 - [Simultaneous Record w/o Filter] in [Filter Settings] is not available.
 - It is not possible to use the HDMI output.
- When recording using the  ([4K Pre-Burst]) function, [Step Zoom] of [Power Zoom Lens] does not operate.
- Scene Detection in Intelligent Auto Mode works the same way as when recording motion pictures.
- When the drive mode is set to 4K Photo, it is not possible to take pictures while recording motion picture. (Only when  ([Photo Priority]) is set)
- The 4K Photo function is disabled when using the following settings:
 - [Clear in Backlight], [Glistening Water], [Artistic Nightscape], [Glittering Illuminations], [Handheld Night Shot], [Clear Night Portrait], [Soft Image of a Flower] (Scene Guide Mode)
 - [Rough Monochrome], [Silky Monochrome], [Miniature Effect], [Soft Focus], [Star Filter], [Sunshine] (Creative Control Mode)
 - During motion picture recording
 - When [Multi Exp.] is set
 - When using [Time Lapse Shot]
 - When using [Stop Motion Animation]
- To select and save pictures from 4K burst files on a PC, use the software "PHOTOfunSTUDIO". Please note that it is not possible to edit a 4K burst file as a motion picture.



Adjusting the focus after recording

((Post Focus)/[Focus Stacking])

Recording mode:

You can record 4K burst pictures while changing the focus point and then select a focus point after recording. This function is best for non-moving subjects.



4K burst recording with automatic focus shift



Touch the desired focus point



Finished picture has the desired focus point

- To record pictures, use a UHS Speed Class 3 card.
- We recommend using a tripod to perform [Focus Stacking].

Recording using [Post Focus]

1 Press button

2 Press to select [ON] and press [MENU/SET]

[Post Focus] icon

- You can also set it to [ON] by pressing the button (), using to select a [Post Focus] icon ().

3 Determine the composition and press the shutter button halfway

- Auto Focus activates and automatically detects the focus point on the screen.
- If there is no focus point on the screen, the Focus indicator () blinks and you cannot record.



From halfway pressing the shutter button to completion of recording

- Do not change the distance to subject or the composition.



Adjusting the focus after recording ([Post Focus]/[Focus Stacking])

4 Press the shutter button fully to start recording**B** Recording progress bar

- The focus point changes automatically while recording. When the recording progress bar disappears, recording automatically ends.
- The data will be saved as a single file in the MP4 format.
- If [Auto Review] is set, a screen will automatically appear that lets you select the focus point. (→134)

**■ Cancelling [Post Focus]**

Select [OFF] in step **2**.

- The operation can be cancelled by pressing the [**4K**] button (▼) and then selecting [□] ([Single]) or [OFF].

**About camera temperature**

If the surrounding temperature is high or [Post Focus] recording is performed continuously, [△] may be displayed and recording may be stopped halfway through. Wait until the camera cools down.



Adjusting the focus after recording ([Post Focus]/[Focus Stacking])

Select the focus point and save the picture ([Post Focus])

1 On the playback screen, select the image with the [▲▶] icon and press ▲

- The same operation can be performed by touching [▲▶].



2 Touch the focus point

- If there are no pictures with the focus on the selected point, a red frame will be displayed, and pictures cannot be saved.
- The edge of the screen cannot be selected.

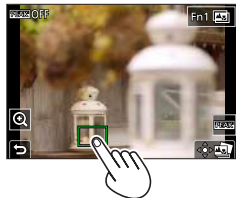

Operation	Touch operation	Description
▲▼▶◀ ☀️	Touch	Selects focus point • No selection can be made while display is enlarged.
☀️		Enlarges the display
☀️		Reduces the display (when in enlarged display)
[Fn1]		Switches to [Focus Stacking] operation (→135)
—		In-focus portions are highlighted with colour. ([Peaking]) • Switches in order of [PEAK OFF] → [PEAK L] ([LOW]) → [PEAK H] ([HIGH]).
[MENU/SET]		Saves the picture

- You can make fine adjustments to the focus by dragging the slide bar during enlarged display. (The same operation can be performed using ◀▶.)

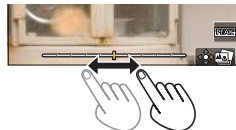

3 Touch [◀▶] to save the picture

- The selected picture will be saved as a new separate file in the JPEG format.



Adjusting the focus after recording ([Post Focus]/[Focus Stacking])

Select the focus range to combine and create a single picture ([Focus Stacking])

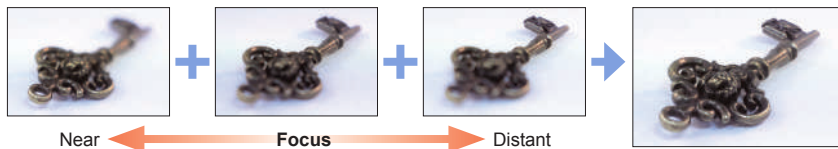

1 Touch on screen in step 2 of "Select the focus point and save the picture ([Post Focus])" (→134)

- The same operation can be performed by pressing the [Fn1] button.

2 Choose a stacking method and touch it

[Auto Merging]	Automatically select photos suitable for stacking and combine them into one picture. <ul style="list-style-type: none"> • Choose by giving preference to near-focus pictures. • Perform the focus stacking and save the picture.
[Range Merging]	Combine the pictures with the selected focus position into one picture.

(When selecting [Range Merging])

3 Touch the focus point

- Select positions at two or more points.
- Focus points between the selected two positions will be selected.
- Positions that cannot be selected, or that would produce an unnatural result will be greyed out.

- Touch a position again to deselect it.
- If you drag the screen you can then continue to select positions.

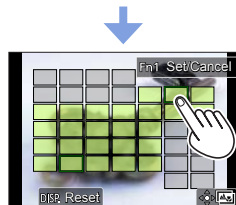

Operation	Touch operation	Description
▲▼◀▶	Touch	Select the position
[Fn1]	[Set/Cancel]	Set/Clear the position
[DISP.]	[All]	Select all positions (Before selecting position)
	[Reset]	Deselect All (After selecting position)
[MENU/SET]		Combine and save picture

Adjusting the focus after recording ([Post Focus]/[Focus Stacking])

4 Touch  to combine and save the picture

- The picture will be saved in JPEG format with recording information (Exif information) from the nearest position's picture, including its shutter speed, aperture and ISO sensitivity information.

Notes on the [Post Focus]/[Focus Stacking]**■ The camera's setup for recording in [Post Focus]**

- Since recording is performed in the same picture quality as 4K photos, certain limitations apply to recording functions and menu settings. For details, refer to "The camera's setup for the 4K Photo function" (→130).
- In addition to the limitations of the 4K Photo function, the following limitations apply to [Post Focus] recording:
 - [AF Mode] cannot be set.
 - Manual Focus cannot be used.
 - The following [Custom] menu item cannot be set: [Shutter AF]
 - Motion pictures cannot be recorded.
 - [Digital Zoom] is not available.
- During recording, the angle of view will be narrower.
- The [Post Focus] function is disabled when using the following settings:
 - [Clear in Backlight], [Glistening Water], [Artistic Nightscape], [Glittering Illuminations], [Handheld Night Shot], [Clear Night Portrait], [Soft Image of a Flower] (Scene Guide Mode)
 - [Rough Monochrome], [Silky Monochrome], [Miniature Effect], [Soft Focus], [Star Filter], [Sunshine] (Creative Control Mode)
 - When [Multi Exp.] is set
 - When using [Time Lapse Shot]
 - When using [Stop Motion Animation]
- When selecting the focus and saving pictures, you cannot select and save the picture from a TV screen even if the camera is connected to a TV through an HDMI micro cable.
- In the following cases, [Focus Stacking] may produce an unnatural picture:
 - If the subject is in motion
 - If there are large differences in distance to the subject
 - If there is significant blurring (recording with a larger aperture might make the picture less unnatural)
- During focus stacking, auto compensation is applied to deviations among pictures due to camera shake. In such cases, the angle of view will be slightly narrower at the time of focus stacking.
- Only pictures taken using [Post Focus] on this camera are eligible for [Focus Stacking].

Selecting a Drive Mode

Recording mode: **P** **A** **S** **M**

You can switch the operation to be performed when you press the shutter button.

1 Press [**4K**] button (▼)

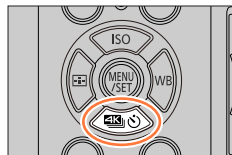

2 Press ◀▶ to select the drive mode and press [MENU/SET]

Ⓐ Drive Mode

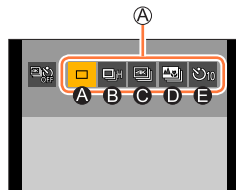

Ⓐ [Single]	When the shutter button is pressed, only one picture is recorded.
Ⓑ [Burst] (→138)	The pictures are recorded in succession while the shutter button is pressed.
Ⓒ [4K PHOTO] (→120)	When the shutter button is pressed, a picture is recorded with the 4K Photo function.
Ⓓ [Post Focus] (→132)	When the shutter button is pressed, the pictures are recorded with [Post Focus].
Ⓔ [Self Timer] (→140)	When the shutter button is pressed, recording takes place after the set time has elapsed.

■ To cancel the drive mode

In step 2, select [□] ([Single]) or [] ([Self Timer Off]).

- You can cancel the self-timer by turning off the camera. (When [Self Timer Auto Off] is set to [ON].)

Burst function

■ Setting [Burst Rate]

- ① Select [Burst] and pressing ▲ in step 2 (→137)
- ② Select the burst rate with ◀▶, and press [MENU/SET]

		[H] (High speed)	[M] (Middle speed)	[L] (Low speed)
Speed (pictures/sec.)	Mechanical shutter	9*1 6*2	6	2
	Electronic Shutter	9*1 6*2	6	2
Live View during burst recording		None*1/ Available*2	Available	Available
Number of recordable pictures*3	With RAW files	30 or more		
	Without RAW files	100 or more		

*1 When the focus mode is set to [AFS] or [MF]

*2 When the focus mode is set to [AFF] or [AFC]

*3 When recording is performed under the test conditions specified by Panasonic.

Pictures can be taken until the card becomes full. However, the burst speed will become slower halfway through the recording. The number of burst pictures is limited by the picture-taking conditions and the type and/or status of the card used.

■ About the maximum number of pictures that can be taken continuously

When you press the shutter button halfway, the maximum number of pictures you can take continuously will appear. You can check the approximate number of pictures that can be taken before the burst speed slows down.

Example: When 20 pictures can be taken: [r20]

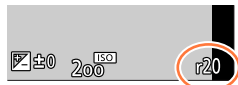

- Once recording starts, the maximum number of pictures that can be taken continuously will decrease. When [r0] appears, the burst speed will slow down.
- When [r99+] is displayed, you can take 100 or more pictures continuously.



Focusing in burst mode

Focusing varies depending on focus settings and the setting of [Focus/Release Priority] in the [Custom] ([Focus / Release Shutter]) menu.

Focus settings	[Focus/Release Priority]	[H]	[M], [L]
[AFS]	[FOCUS]/ [BALANCE]/ [RELEASE]	At the first picture	
[AFF] / [AFC]*1	[FOCUS]	Predicted focusing*2	Normal focusing*3
	[BALANCE]/ [RELEASE]	Predicted focusing*2	
[MF]	—	Focus set with Manual Focus	

*1 Focus is fixed in the first picture when dark subjects are recorded.

*2 The camera predicts the focus within a possible range by giving higher priority to the burst speed.

*3 Since the camera records a burst of pictures while it adjusts the focus, the burst speed may be slower.



- The burst speed may become slower depending on the following settings: [Sensitivity], [Picture Size], [Quality], focus mode, [Focus/Release Priority]
- When the burst speed is set to [H] (focus mode is set to [AFS] or [MF]), the exposure and White Balance are fixed to those of the first picture.
When the burst speed is set to [H] (focus mode is set to [AFF] or [AFC]), [M] or [L], the exposure and White Balance are adjusted individually for each still picture.
- **It may take a while to store still pictures that were taken using the burst function. If you continue to record while storing, the number of burst pictures that can be taken will be reduced. A high-speed card is recommended when recording using the burst function.**
- This function is not available in the following cases:
 - [Glistening Water], [Glittering Illuminations], [Handheld Night Shot], [Soft Image of a Flower] (Scene Guide Mode)
 - [Rough Monochrome], [Silky Monochrome], [Miniature Effect], [Soft Focus], [Star Filter], [Sunshine] (Creative Control Mode)
 - When recording using the flash
 - When [Multi Exp.] is set
 - When using [Time Lapse Shot]
 - When [Auto Shooting] of [Stop Motion Animation] is set to [ON]



Taking pictures with self-timer

■ Setting the self-timer operation

- ① Select [Self Timer] and pressing ▲ in step 2 (→137)
- ② Select the self-timer operation with ◀▶, and press [MENU/SET]

	The shutter is activated after 10 seconds.
	The shutter is activated after 10 seconds and three pictures are taken at intervals of approximately 2 seconds.
	The shutter is activated after 2 seconds. This is also effective for preventing jitter when pressing the shutter button.

- After the self-timer indicator flashes, recording will start.
- The focus and exposure are fixed when the shutter button is pressed halfway.
- We recommend using a tripod.
- It cannot be set to [⌚] in the following cases:
 - When recording using [Bracket]
 - When [Multi Exp.] is set
 - When [Simultaneous Record w/o Filter] of [Filter Settings] is set to [ON]
- This function is not available in the following cases:
 - During motion picture recording
 - When using [Time Lapse Shot]
 - When [Auto Shooting] of [Stop Motion Animation] is set to [ON]



Taking Pictures While Adjusting a Setting Automatically (Bracket Recording)

Recording mode:

You can take multiple pictures while automatically adjusting a setting by pressing the shutter button.

1 Set the menu

MENU → **[Rec]** → **[Bracket]** → **[Bracket Type]**

(Exposure Bracket)	Press the shutter button to perform recording while adjusting the exposure. (→142)
(Aperture Bracket)	Press the shutter button to perform recording while adjusting the aperture. (→143) • Available in Aperture-Priority AE Mode or when the ISO sensitivity is set to [AUTO] in Manual Exposure Mode.
FOCUS (Focus Bracket)	Press the shutter button to perform recording while adjusting the focus position. (→144)
WB (White Balance Bracket)	Press the shutter button once to take three pictures with different white balance settings automatically. (→119)

2 Press ▼ to select [More Settings] and then press [MENU/SET]

- For information on [More Settings], refer to the page that describes each function.
- Press the shutter button halfway to exit the menu.

3 Focus on the subject and take a picture

- When Exposure Bracket is selected, the bracket display flashes until all of the pictures you have set are taken. If you change the bracket settings or turn off the camera before all of the pictures you have set are taken, the camera restarts recording from the first picture.

■ To cancel [Bracket]

Select [OFF] in step 1.

Taking Pictures While Adjusting a Setting Automatically (Bracket Recording)

- Bracket recording is disabled in the following cases.
 - [Glistening Water], [Glittering Illuminations], [Handheld Night Shot], [Soft Image of a Flower] (Scene Guide Mode)
 - [Rough Monochrome], [Silky Monochrome], [Miniature Effect], [Soft Focus], [Star Filter], [Sunshine] (Creative Control Mode)
 - When recording using the flash (except for White Balance Bracket)
 - When recording motion pictures
 - When recording 4K photos
 - When recording using [Post Focus]
 - When [Multi Exp.] is set
 - When using [Time Lapse Shot]
 - When [Auto Shooting] of [Stop Motion Animation] is set to [ON]

Exposure Bracket

■ About [More Settings] (step 2 in (→141))

[Step]	Sets the number of pictures to be taken and the exposure compensation range. [3•1/3] (Takes three pictures with an interval of 1/3 EV) to [7• 1] (Takes seven pictures with an interval of 1 EV)
[Sequence]	Sets the order in which pictures are taken.
[Single Shot Setting]*	[□]: Takes one picture each time you press the shutter button. [□]: Takes all the pictures set to be taken when you press the shutter button once.

* Not available for burst recording. When using burst recording, if you press and hold the shutter button, recording will be performed continuously until a specified number of pictures are taken.

[Step]: [3•1/3], [Sequence]: [0/-/+]

1st picture



±0 EV

2nd picture



-1/3 EV

3rd picture



+1/3 EV

- When taking pictures using Exposure Bracket after setting the Exposure Compensation value, the pictures taken are based on the selected Exposure Compensation value.

Taking Pictures While Adjusting a Setting Automatically (Bracket Recording)

Aperture Bracket

Recording mode: **A|M**

■ About [More Settings] (step 2 in (→141))

[Image Count]

[3]/[5]: Takes a specified number of pictures with different aperture values within the range based on the initial aperture value.

[ALL]: Takes pictures using all aperture values.

- When using burst recording, if you press and hold the shutter button, recording will be performed until a specified number of pictures are taken.

The available aperture values vary depending on the lens.

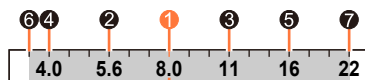
Example: when using the interchangeable lens (H-FS12032)**When the initial position is set to F8.0:**

① first picture, ② second picture, ③ third picture... ⑦ seventh picture

Taking Pictures While Adjusting a Setting Automatically (Bracket Recording)

Focus Bracket

■ About [More Settings] (step 2 in (→141))

[Step]	Sets the interval between focus positions.
[Image Count]*	Sets the number of pictures to be taken.
[Sequence]	<p>[0/-/+]: Takes pictures with different focus positions within the range based on the initial focus position.</p> <p>[0/+]: Takes pictures with different focus positions toward the far side based on the initial focus position.</p>

* Not available for burst recording. When using burst recording, if you press and hold the shutter button, recording will be performed continuously until a specified number of pictures are taken.

[Sequence]: Example when [0/-/+]
[Sequence]: Example when [0/+]

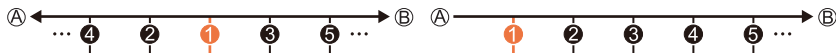

Ⓐ Close-up

Ⓑ Infinity

① first picture, ② second picture... ⑤ fifth picture...

- Pictures taken with Focus Bracket are displayed as a set of group pictures.

Taking pictures automatically at set intervals

[Time Lapse Shot]

Recording mode: **P** **A** **S** **M**

You can preset data such as recording start time and time lapse to take still pictures automatically. This setting is convenient for taking pictures at constant intervals for landscape scenes, observation of the gradual changes in animals/plants, and other applications. The pictures are recorded as a set of group pictures.

- Complete the date and time settings in advance. (→40)

1 Set the menu

MENU → [Rec] → [Time Lapse Shot]		
[Shooting Interval Setting]	[ON]: Sets the time from recording start time to the next recording start time. [OFF]: After recording is finished, the next recording is started without any interval.	
[Start Time]	[Now]	Starts the recording by fully-pressing the shutter button.
	[Start Time Set]	Any time up to 23 hours 59 minutes ahead can be set. ① Press ◀▶ to select the item (hour and/or minute), and ▲▼ to set the start time, and press [MENU/SET]
[Image Count] / [Shooting Interval]*1	◀▶ : Select the item (digit) ▲▼ : Setting [MENU/SET]: Set	

*1 Can be set only when [Shooting Interval Setting] is set to [ON].

- The estimated recording ending time is displayed on the setting screen. (When [Shooting Interval Setting] is set to [OFF], the recording ending time is displayed only when the focus mode is set to [MF] in Shutter-Priority AE Mode or Manual Exposure Mode.)
- The camera may not be able to record using the pre-set interval and number of pictures to be recorded or may not finish recording at the estimated recording ending time under some recording conditions.

2 Press ▲ to select [Start] and press [MENU/SET]



3 Press the shutter button halfway to focus



Taking pictures automatically at set intervals [Time Lapse Shot]

4 Press the shutter button fully

- The recording starts automatically.
- During recording standby, the camera turns off automatically when no operation is performed for a preset interval. The [Time Lapse Shot] recording will continue even if the camera is turned off, and the camera is automatically turned on at the recording start time. If you want to turn on the camera manually, press the shutter button halfway.
- Operations during recording standby (The camera is turned on)

Operation	Touch operation	Description
[Fn1]*2	 *3	Displays a selection screen that lets you pause or stop the recording
		Displays a selection screen that lets you resume or stop the recording (during pause)

*2 When you record pictures by setting [Shooting Interval Setting] to [OFF], you can press [Fn1] even while recording is in progress. After recording (exposure) of a picture taken at the time when you pressed [Fn1] is finished, a selection screen is displayed.

*3 When you record pictures by setting [Shooting Interval Setting] to [OFF], you cannot perform touch operation.

5 Select the motion picture creation method

- [Rec Format]: [MP4]

[Rec Quality]	Sets the picture quality of the motion picture.
[Frame Rate]	Set the number of frames per second. The higher the number is, the smoother the motion picture will be.
[Sequence]	[NORMAL]: Stitches the still pictures in the recording sequence. [REVERSE]: Stitches the still pictures in the reverse order of recording.

6 Press ▲ to select [OK] and press [MENU/SET]

- You can also create a motion picture using [Time Lapse Video] in the [Playback] menu.



Taking pictures automatically at set intervals [Time Lapse Shot]

- This function is not intended for application-specific systems (monitoring cameras).
- [Time Lapse Shot] is paused in the following cases:
 - When the remaining battery power runs out
 - Turning the camera offIf the number of pictures set has not been taken yet, you can restart the operation by turning off the camera in the pause state, replacing the battery or card, and then turning the camera on again. (Note, however, that the pictures recorded after restarting the operation are saved as a separate set of group pictures.)
- We recommend using auto focus for time lapse recording in cases where a long [Shooting Interval] is set and the camera will turn off automatically between shots.
- When creating motion pictures at a picture quality size of [4K], recording times are limited to 29 minutes and 59 seconds.
If using an SDHC memory card, you will not be able to create motion pictures with a file size greater than 4 GB. With an SDXC memory card, you can create motion pictures with a file size greater than 4 GB.
- When creating a motion picture with a picture quality size of [FHD] or [HD], you will be unable to create it if the recording time is more than 29 minutes and 59 seconds or the file size is greater than 4 GB.
- This function is not available in the following cases:
 - [Handheld Night Shot] (Scene Guide Mode)
 - When [Multi Exp.] is set
 - When using [Stop Motion Animation]



Creating stop motion animation [Stop Motion Animation]

Recording mode: P A S M

You can stitch still pictures to create stop motion animation. The pictures are recorded as a set of group pictures.

- Complete the date and time settings in advance. (→40)

1 Set the menu

MENU → [Rec] → [Stop Motion Animation]	
[Auto Shooting]	[ON]: Takes pictures automatically at a set recording interval. [OFF]: Takes pictures manually, one frame at a time.
[Shooting Interval]	(Only when [Auto Shooting] is set to [ON]) Set the interval used for [Auto Shooting].

2 Press ▲ to select [Start] and press [MENU/SET]

3 Press ▲ to select [New] and press [MENU/SET]

4 Press the shutter button halfway to focus

5 Press the shutter button fully

- Up to 9,999 frames can be recorded.

6 Move the subject to decide on the composition

- Repeat the recording of still pictures in the same way.
- When you turn off the camera during recording, a message to restart recording will appear when you turn on the camera.

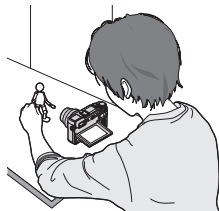

How to create stop motion animation effectively

- Up to two previously recorded pictures are displayed on the recording screen. Check this screen as a guideline for determining the amount of required motion.
- You can press [▶] (Playback) button to check the recorded pictures. Press [⏮] button to delete unnecessary pictures. To return to the recording screen, press [▶] (Playback) button again.

Creating stop motion animation [Stop Motion Animation]

7 Touch [] to end the recording

- You can also end the recording by selecting [Stop Motion Animation] in the [Rec] menu, and then pressing [MENU/SET].
- When [Auto Shooting] is set to [ON], select [End] on the confirmation screen. (If you select [Pause], press the shutter button fully to resume recording.)

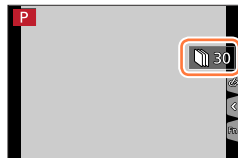
**8 Select a method to create a stop motion animation**

- [Rec Format]: [MP4]

[Rec Quality]	Sets the picture quality of the motion picture.
[Frame Rate]	Set the number of frames per second. The higher the number is, the smoother the motion picture will be.
[Sequence]	[NORMAL]: Stitches the still pictures in the recording sequence. [REVERSE]: Stitches the still pictures in the reverse order of recording.

9 Press ▲ to select [OK] and press [MENU/SET]

- You can also create a stop motion animation using [Stop Motion Video] in the [Playback] menu.

■ Adding pictures to an already recorded stop motion animation group

When you select [Additional] in step 3, group pictures recorded using [Stop Motion Animation] are displayed. Select a set of group pictures and press [MENU/SET]. Then, select [Yes] on the confirmation screen.

Creating stop motion animation [Stop Motion Animation]

- [Auto Shooting] may not be performed according to the preset interval because recording could take time under some recording conditions, such as when pictures are taken using a flash.
- When creating motion pictures at a picture quality size of [4K], recording times are limited to 29 minutes and 59 seconds.
If using an SDHC memory card, you will not be able to create motion pictures with a file size greater than 4 GB. With an SDXC memory card, you can create motion pictures with a file size greater than 4 GB.
- When creating a motion picture with a picture quality size of [FHD] or [HD], you will be unable to create it if the recording time is more than 29 minutes and 59 seconds or the file size is greater than 4 GB.
- You cannot select only one recorded still picture using [Additional].
- This function is not available in the following cases:
 - When [Multi Exp.] is set
 - When using [Time Lapse Shot]
- [Auto Shooting] in [Stop Motion Animation] cannot be used in the following case:
 - [Handheld Night Shot] (Scene Guide Mode)



Correcting jitter

The camera can activate either the In-Lens Image Stabiliser or In-Body Image Stabiliser, or it can activate both of them and reduce jitter even more effectively. (Dual I.S.)

For motion picture recording, you can use the 5-Axis Hybrid Image Stabiliser, which makes use of the In-Lens Image Stabiliser, In-Body Image Stabiliser, and Electronic Image Stabiliser.

- The image stabilisers to be activated differ depending on your lens. The icon for the currently activated image stabiliser is displayed on the recording screen.

	When taking pictures	When recording motion pictures
Panasonic lenses compatible with Dual I.S. (Based on the Micro Four Thirds System standard) <ul style="list-style-type: none"> • For the latest information on compatible lenses, please refer to our website. (→20) • If [Dual I.S.], [Dual I.S.] or [Dual I.S.] is not displayed even when a compatible lens is used, update the lens firmware to the latest version. (→20) 	Lens + Body (Dual I.S.) (Dual I.S. / Dual I.S.)	Lens + Body (Dual I.S.) (Dual I.S.), 5-Axis Hybrid (Dual I.S.)*
Lenses compatible with the image stabiliser function (Based on the Micro Four Thirds System standard/ Four Thirds System standard)	Lens or Body (I.S. / I.S.)	Lens or Body (I.S.), 5-Axis Hybrid (I.S.)*
Lenses not compatible with the image stabiliser function (Based on the Micro Four Thirds System standard/ Four Thirds System standard)	Body (I.S. / I.S.)	Body (I.S.), 5-Axis Hybrid (I.S.)*
When using a Leica lens mount adaptor (optional) or mount adaptor made by another manufacturer		

* When [E-Stabilization (Video)] is set to [ON]



To prevent jitter

If a warning is displayed about jitter, use [Stabilizer], a tripod, or [Self Timer].

- Using a slower shutter speed can cause motion blur. Shutter speed will be slower particularly in the following cases. Keep the camera still from the moment the shutter button is pressed until the picture appears on the screen.

We recommend using a tripod.

- [Slow Sync.]
- [Slow Sync./Red-Eye]
- [Clear Nightscape], [Cool Night Sky], [Warm Glowing Nightscape], [Artistic Nightscape], [Glittering Illuminations], [Clear Night Portrait] (Scene Guide Mode)



Recording mode: **PAS**

- When using an interchangeable lens with [O.I.S.] switch (such as H-FS14140), stabiliser function is activated if the [O.I.S.] switch of the lens is set to [ON] (). (is set at the time of purchase.)

MENU → **[Rec]** / **[Motion Picture]** → **[Stabilizer]**

[Operation Mode]	(Normal)	Corrects vertical, horizontal and rotational jitter.
	(Panning)	Corrects vertical jitter. This setting is ideal for panning (technique of recording a subject by matching the camera movement with the movement of a subject going in a specific direction).
	[OFF]	[Stabilizer] does not work. () <ul style="list-style-type: none"> • When using a lens with an [O.I.S.] switch, set the switch to [OFF].
[E-Stabilization (Video)]	Jitter during motion picture recording is corrected along the vertical, horizontal, roll, pitch, and yaw axes by making use of the In-Lens Image Stabiliser, In-Body Image Stabiliser, and Electronic Image Stabiliser. (5-Axis Hybrid Image Stabiliser) [ON] / [OFF] <ul style="list-style-type: none"> • When [ON] is selected, the angle of view of recorded motion pictures may become narrower. 	
[I.S. Lock (Video)]	Allows you to enhance the image stabilization effect during motion picture recording. This effect can keep the motion blur in the composition minimal when you want to perform recording from a fixed perspective. [ON] / [OFF] <ul style="list-style-type: none"> • This effect works only during recording. () is displayed on the recording screen. • To change the composition during recording, set the effect to [OFF] first, and then move the camera. Use the appropriate function button to change the setting to [OFF] during recording. (→60) • In situations where the focal length becomes greater, such as when a telephoto lens is attached, the stabilization effect will be weaker. • The stabilization effect may be weak depending on the lens used. 	
[Focal Length Set]	If the focal length is not set automatically, you can set it manually. <ul style="list-style-type: none"> • When a manually selected focal length is set, a confirmation screen asking you to change the focal length setting is displayed after you turn on the camera. Selecting [Yes] allows you to set [Focal Length Set] in [Stabilizer]. 	



Setting the focal length of a lens

MENU → **📷 [Rec] / 🎬 [Motion Picture]** → **[Stabilizer]** → **[Focal Length Set]**

1 Enter a focal length

◀▶: Select the item (digit); ▲▼: Setting

- A focal length ranging from 0.1 mm to 1000 mm can be set.

2 Press [MENU/SET]



■ Registering a focal length

① Perform step **1**

② Press ▶ to select the focal length to be overwritten and then press [DISP.] button

- Up to 3 focal length settings can be registered.



■ Setting a registered focal length

① On the screen in step **1**, press ▶ to select the registered focal length and then press [MENU/SET]



- **The Image Stabiliser may produce operational sound or cause vibration during its operation, but these are not malfunctions.**
- When you use a tripod, we recommend setting [Operation Mode] to [OFF].
- [Stabilizer] cannot be used by selecting [(👤)] (Normal) in Panorama Shot Mode.
- In the following cases, the [Stabilizer] will switch to [(👤)] (Normal), even if it is set to [(👤)] (Panning):
 - During motion picture recording
 - When recording 4K photos
 - When recording using [Post Focus]
- Cases where the stabiliser function may be ineffective:
 - When there is a lot of jitter
 - When the zoom magnification is high (also in the Digital Zoom range)
 - When taking pictures while following a moving subject
 - When the shutter speed becomes slower to take pictures indoors or in dark places
- The panning effect by selecting [(👤)] is not fully achieved in the following cases:
 - Bright summer days or other bright locations
 - When the shutter speed is higher than 1/100 seconds
 - When the motion of a subject is slow and the speed with which the camera is moved is too slow (a nice background blur is not achieved)
 - When the camera is not adequately tracking the motion of a subject
- [E-Stabilization (Video)] is not available in the following cases.
 - When using the Digital Zoom
 - When [4K Live Cropping] is set



Using Zoom

Optical Zoom

Recording mode:   P A S M   

You can zoom-in to make people and objects appear closer or zoom-out to record landscapes, etc.

T side: Enlarges distant subject

W side: Widens angle of view

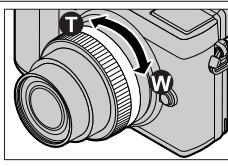
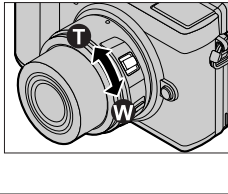
<p>Interchangeable lens with a zoom ring (H-FS12032/H-FS35100/ H-FS12060/H-FS1442A/ H-FS14140)</p>	<p>Rotate the zoom ring.</p>	
<p>Interchangeable lens that supports the power zoom (electrically operated zoom)</p>	<p>Move the zoom lever. (The zoom speed varies depending on how far you move the lever.)</p> <ul style="list-style-type: none"> • If you set [Zoom Control] to a function button, you can operate the optical zoom slowly by pressing ◀▶ or fast by pressing ▲▼. <p>For information on how to operate (→157)</p>	
<p>Interchangeable lens that does not support the zoom (H-H020A)</p>	<p>The optical zoom is not available.</p>	



Raising the telescopic effect

[Ex. Tele Conv.]

Recording mode:   P A S M   

Extra Tele Conversion enables you to take pictures that are further enlarged without deteriorating the picture quality.

[Ex. Tele Conv.]* ¹ ([Rec])	1.3x (when [Picture Size] is set to [EX M] ([16:9])) 1.4x (when [Picture Size] is set to [EX M] ([4:3], [3:2], [1:1])) 2.0x (when [Picture Size] is set to [EX S])
[Ex. Tele Conv.]* ² ([Motion Picture])	2.7x (motion pictures with a [Rec Quality] size of [FHD]) 4.0x (motion pictures with a [Rec Quality] size of [HD])

*¹ Active when [Picture Size] is set to [M] or [S] (number of pixels with [EX]).

*² Active when the [Rec Quality] size setting is [FHD] or [HD].



■ Increasing the zoom magnification in steps

- This can be used only when recording pictures.

MENU → **[Rec.]** → **[Ex. Tele Conv.]** → **[ZOOM]**

① Set a function button to [Zoom Control] (→60)

② Press the function button

③ Press ◀▶ or ▲▼

▲▶: Tele (Enlarges distant subject)

▼◀: Wide (Widens angle of view)

- The zoom operation is terminated when the function button is pressed again or a certain amount of time passes.



Ⓐ Optical Zoom range (Focal length)*

Ⓑ Extra Tele Conversion range for still picture recording (Zoom magnification)



* This zoom slider is displayed when using an interchangeable lens that supports the power zoom.

- A constant zoom speed will be set.
- The indicated zoom magnification is an approximation.

■ Fixing the zoom magnification at the maximum level

MENU → **[Rec.]** → **[Ex. Tele Conv.]** → **[TELE CONV.]**

MENU → **[Motion Picture]** → **[Ex. Tele Conv.]** → **[ON]**

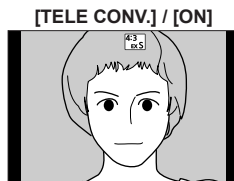
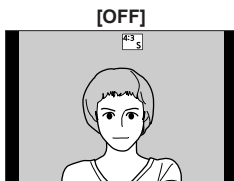

- If you assign [Ex. Tele Conv.] to [Fn Button Set] in the [Custom] ([Operation]) menu, you can display the Extra Tele Conversion setting screen for both pictures and motion pictures by pressing the assigned function button. While this screen is displayed, you can change the [Picture Size] setting by pressing [DISP.] button.
- This function is not available in the following cases:
 - [Toy Effect], [Toy Pop] (Creative Control Mode)
 - When [Quality] is set to [RAW]
 - When recording 4K photos
 - When recording using [Post Focus]
 - When [HDR] is set to [ON]
 - When [Multi Exp.] is set
 - When [4K Live Cropping] is set
- [Ex. Tele Conv.] ([Rec]) is not available in the following case.
 - [Handheld Night Shot] (Scene Guide Mode)
- [Ex. Tele Conv.] ([Motion Picture]) is not available in the following case.
 - When using the HDMI output during recording (Except in Creative Video Mode)

[Digital Zoom]



Recording mode:   **PAS** **M**   

You can increase the zoom ratio up to 4x higher than the original zoom ratio.

Note that, with Digital Zoom, enlarging will decrease picture quality.

MENU →  **[Rec]** /  **[Motion Picture]** → **[Digital Zoom]**

Settings: **[4x]** / **[2x]** / **[OFF]**

- When using [Digital Zoom], we recommend using a tripod and the self-timer (→140) for taking pictures.
- The AF area is largely displayed at the centre in the Digital Zoom range.
- This function is not available in the following cases:
 - [Toy Effect], [Toy Pop], [Miniature Effect] (Creative Control Mode)
 - When recording using [Post Focus]
 - When [HDR] is set to [ON]
 - When [Multi Exp.] is set
 - When [Quality] is set to [RAW , [RAW ] or [RAW]





Changing the settings for a power zoom lens

Recording mode: 

Sets the screen display and operations when using an interchangeable lens that is compatible with power zoom (electrically operated zoom).

- This may only be selected when using a lens that is compatible with power zoom (electrically operated zoom).

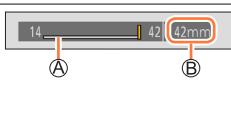
MENU →  **[Custom]** →  **[Lens / Others]** → **[Power Zoom Lens]**

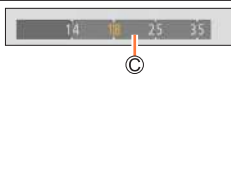
[Disp Focal Length]	When you zoom, the focal distance is displayed and you can confirm the zoom position. (A) Focal distance indication (B) Current focal distance	
[Step Zoom]	When you operate the zoom with this setting [ON], the zoom will stop at positions corresponding to predetermined distances. (C) Step zoom indication • This setting does not work when recording motion pictures or 4K photos with  (4K Pre-Burst).	
[Zoom Speed]	You can set the zoom speed for zoom operations. • If you set [Step Zoom] to [ON], the zoom speed will not change. [Photo]: [H] (High speed) / [M] (Middle speed) / [L] (Low speed) [Video]: [H] (High speed) / [M] (Middle speed) / [L] (Low speed)	
[Zoom Ring]	This may only be selected when a power zoom-compatible lens with a zoom lever and zoom ring is attached. When set to [OFF], the operations controlled by the zoom ring are disabled to prevent accidental operation.	



Using the zoom by performing touch operations (Touch zoom)

(Optical Zoom and Extra Tele Conversion for still picture recording are operable)

- If you are using an interchangeable lens not supporting power zoom (H-FS12032/H-FS35100/H-FS12060/H-FS1442A/H-H020A/H-FS14140), you can only operate Extra Tele Conversion for pictures by setting [Ex. Tele Conv.] ([Rec]) (→156) to [ZOOM].

1 Touch [◀]

2 Touch [T_w↑]

- The slide bar is displayed.



3 Perform zoom operations by dragging the slide bar

- The zoom speed varies depending on the touched position.

[▼] / [▲]	Slow zooming
[▼] / [▲]	Fast zooming

- Touch [T_w↑] again to end touch zoom operations.



Taking pictures with flash

Recording mode:

■ Open/Close the built-in flash

A To open the flash

Press [] (Flash open) button.

- Be careful when opening the flash as the flash will jump out.

B To close the flash

Press the flash until it clicks.

- Be careful not to catch a finger or any other part of your body or any object when you close the flash.
- Forcibly closing the flash can damage the camera.
- Be sure to close the built-in flash when not in use.
- The flash setting is fixed to [] (Forced Flash Off) while the flash is closed.

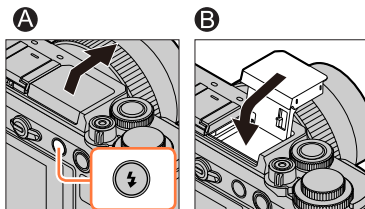

■ The available flash range

When you use certain lenses, light from the flash may be blocked or fail to cover the lens field of view, causing dark areas to appear in the resulting pictures.

The distance at which light from the flash is blocked by lens, and the distance to which light from the flash is delivered vary depending on the lens used. Check the distance to the subject when taking a picture.

When the interchangeable lens (H-FS12032) is used

Wide	Tele
0.4 m (1.3 feet) to 4.8 m (16 feet)	0.3 m (0.98 feet) to 3.0 m (9.8 feet)

When the interchangeable lens (H-FS35100) is used

Wide	Tele
0.9 m (3.0 feet) to 4.2 m (14 feet)	0.9 m (3.0 feet) to 3.0 m (9.8 feet)

When the interchangeable lens (H-FS12060) is used (When the aspect ratio is [4:3])

Wide to 24 mm	25 mm	Tele
Vignetting effect occurs due to the light of the flash.	1.0 m (3.3 feet) to 3.7 m (12 feet)	0.8 m (2.6 feet) to 3.0 m (9.8 feet)

Taking pictures with flash

When the interchangeable lens (H-FS1442A) is used

Wide	Tele
0.8 m (2.6 feet) to 4.8 m (16 feet)	0.3 m (0.98 feet) to 3.0 m (9.8 feet)

When the interchangeable lens (H-H020A) is used

0.5 m (1.6 feet) to 9.8 m (32 feet)

When the interchangeable lens (H-FS14140) is used
(When the aspect ratio is [4:3])

Wide to 34 mm	35 mm	Tele
Vignetting effect occurs due to the light of the flash.	0.8 m (2.6 feet) to 3.7 m (12 feet)	0.5 m (1.6 feet) to 3.0 m (9.8 feet)

- These ranges are obtained, the ISO sensitivity is set to [AUTO], and [ISO Auto Upper Limit (Photo)] is set to [AUTO].



Using the flash skilfully

When taking pictures with flash with the lens hood attached, the lower portion of the photo may turn dark and the control of the flash may be disabled because the photo flash may be obscured by the lens hood. We recommend detaching the lens hood.

- Avoid doing the following, as the heat or light could cause deformation or discolouration.
 - Putting the flash close to objects
 - Covering the flash with your hand as it is firing
 - Closing the flash as it is firing
- Do not close the flash immediately after the preliminary flash is operated prior to taking pictures for Forced ON/Red-Eye Reduction and other flash settings. If you close the flash immediately, it will cause a malfunction.
- Flash charging may take time if battery is low or if using flash repeatedly. When the flash is being charged, the flash icon flashes red, and you cannot take a picture even when you fully press the shutter button.
- When an External Flash is attached, it will have priority over the built-in flash. For information about external flash, refer to (→313).



Setting the Flash Functions

Changing the firing mode (Manual flash)

Recording mode: **P** **A** **S** **M**

You can select whether the flash output is set automatically or manually. This item is available only when the built-in flash is being used.

MENU → **[Rec]** → **[Flash]** → **[Firing Mode]**

[TTL]

The camera automatically sets the flash output.

[MANUAL]

You can set the flash ratio manually. Even in the case of dark scenes where the flash output tends to be higher in [TTL], this mode allows you to take a picture as intended. The flash ratio (such as [1/1]) is displayed on the flash icon.

■ Setting the flash ratio (When [MANUAL] is selected)

MENU → **[Rec]** → **[Flash]** → **[Manual Flash Adjust.]**

- ① Press ◀▶ to select an item and press [MENU/SET]
- You can set the flash ratio from [1/1] (flash firing full power) to [1/128] in 1/3 steps.

Changing Flash Mode

Recording mode: **PAS** **M**

Set the flash to match the recording.

MENU → **[Rec]** → **[Flash]** → **[Flash Mode]**

: [Forced Flash On]	The flash is activated every time regardless of the recording conditions.
: [Forced On/Red-Eye]*1	<ul style="list-style-type: none"> Use this when your subject is back-lit or under fluorescent light.
: [Slow Sync.]	Takes brighter pictures such as pictures of subjects against a nightscape by decreasing the shutter speed when firing a flash.
: [Slow Sync./Red-Eye]*1	<ul style="list-style-type: none"> Ideal for taking pictures of people against a nightscape. Using a slower speed can cause motion blur. We recommend using a tripod.
: Forced Flash Off	<p>Always takes pictures without flash under all recording conditions.</p> <ul style="list-style-type: none"> Ideal for taking pictures where the use of flash is prohibited. This item is available only when using an external flash.

- *1 This is available only when [Wireless] in the [Flash] is set to [OFF] and [Firing Mode] is set to [TTL].
- Some flash modes may not be available depending on the external flash settings.

The flash is activated twice. The interval between the first and second flash is longer when [] or [] is set. The subject should not move until the second flash is activated.

- The red-eye reduction effect varies depending on the subject and is affected by factors such as distance from the subject and whether the subject is looking at the camera during the preliminary flash. In some cases, red-eye reduction may be negligible.

Shutter speeds for each flash mode

Flash Mode	Shutter speed (seconds)	Flash Mode	Shutter speed (seconds)
	1/60*2 - 1/200		1 - 1/200

*2 The shutter speed is set to 60 seconds in Shutter-Priority AE Mode. The shutter speed is set to T (Time) in Manual Exposure Mode.

- In Intelligent Auto Mode ([] or []), the shutter speed changes depending on the detected scene.

Setting the Flash Functions

■ Flash settings for each Recording mode (○: Available, –: Not available)

Recording mode*3					
P	Programme AE Mode	○	○	○	○
A	Aperture-Priority AE Mode	○	○	○	○
S	Shutter-Priority AE Mode	○	○	–	–
M	Manual Exposure Mode	○	○	–	–
SCN Scene Guide Mode (●: Default settings)	[Clear Portrait]	○	●	–	–
	[Silky Skin]	○	●	–	–
	[Clear in Backlight]	●	–	–	–
	[Sweet Child's Face]	○	●	–	–
	[Clear Night Portrait]	–	–	–	●
	[Soft Image of a Flower]	●	–	–	–
	[Appetizing Food]	●	–	–	–
	[Cute Dessert]	●	–	–	–
	[Freeze Animal Motion]	●	–	–	–
[Clear Sports Shot]	●	–	–	–	
[Monochrome]	●	○	○	○	

*3 For details about flash settings in Intelligent Auto Mode ([IA] or [IA⁺]), refer to (→65).



- The flash is fixed to (Forced Flash Off) in the following cases:
 - [Backlit Softness], [Relaxing Tone], [Distinct Scenery], [Bright Blue Sky], [Romantic Sunset Glow], [Vivid Sunset Glow], [Glistening Water], [Clear Nightscape], [Cool Night Sky], [Warm Glowing Nightscape], [Artistic Nightscape], [Glittering Illuminations], [Handheld Night Shot] (Scene Guide Mode)
 - During motion picture recording
 - When recording 4K photos
 - When recording using [Post Focus]
 - **When using the electronic shutter**
 - When [HDR] is set to [ON]
 - **When [Silent Mode] is set to [ON]**
 - When a picture effect in [Filter Effect] of [Filter Settings] is set
- The Scene Guide Mode flash setting is returned to the initial value with each change of scene.

Setting the 2nd curtain sync

Recording mode: **PAS** **M**

2nd curtain sync is a recording method in which the flash fires just before the shutter closes when you take a picture of a moving subject (such as a car) using the flash with a slow shutter speed.

MENU → **[Rec]** → **[Flash]** → **[Flash Synchro]**

[1ST]	1st curtain sync is the normal recording method when using the flash.	
[2ND]	The light source is captured in back of the subject and this produces a picture that is vibrant and lively.	

- If you set to [2ND], [2nd] will be displayed in the flash icon on the screen.
- This function is available only when [Wireless] in the [Flash] is set to [OFF].
- The [Flash Synchro] setting functions even when an external flash is used.
- When a fast shutter speed is set, the [Flash Synchro] effect may not be sufficiently achieved.
- When [2ND] is set, you cannot set the flash setting to [] or [].



Adjusting the flash output

Recording mode: **PAS** **M** **SCN**

Adjust the flash output if a picture taken using the flash is too bright or too dark.

MENU → **[Rec]** → **[Flash]** → **[Flash Adjust.]**

1 Press ◀▶ to set the flash output and press [MENU/SET]

Settings: -3 EV to +3 EV (unit: 1/3 EV)

When you do not want to adjust the intensity of the flash, select [±0 EV].

- When the intensity of the flash is adjusted, [+] or [-] is displayed on the flash icon.
- [Flash Adjust.] is available only when [Wireless] in the [Flash] is set to [OFF] and [Firing Mode] is set to [TTL].
- The [Flash Adjust.] setting functions even when an external flash is used.

Synchronising the flash output with the camera during Exposure Compensation

Recording mode: **PAS** **M** **SCN**

The flash output is automatically adjusted in accordance with the exposure compensation value.

MENU → **[Rec]** → **[Flash]** → **[Auto Exposure Comp.]**

Settings: [ON] / [OFF]

- About Exposure Compensation (→112)
- The [Auto Exposure Comp.] setting functions even when an external flash is used. (→313)



Taking Pictures with Wireless Flashes

Recording mode: **PAS** **M**

When you use the flashes (DMW-FL200L, DMW-FL360L, DMW-FL580L: optional) with the wireless flash recording function, you can separately control the firing of the flashes in three groups and the flash attached to the hot shoe of the camera.

- The built-in flash does not support wireless flash control.

Flash controllable range

Position the wireless flash with its wireless sensor facing the camera. The following illustration is an example of the range within which the flash can be positioned. The flash controllable range varies depending on the surrounding environment.

Flash controllable range

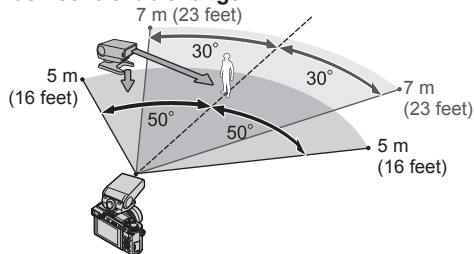

Example of positioning flashes

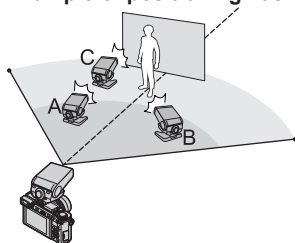

- This flash positioning example shows a case where flash unit C is positioned in order to eliminate the shadows from the subject's background, which is produced by flash unit A and flash unit B of the flash group.
- For the number of wireless flashes to be controlled, we recommend setting up to three flash units in each group.
- When a subject is too close, the communication light emission may affect the exposure of the picture. This problem can be mitigated if you decrease the flash output by setting [Communication Light] to [LOW] or using a flash diffuser or similar device.



Taking Pictures with Wireless Flashes

Preparation

Attach a flash (optional) to this unit.

1 Set the wireless flash to RC mode and position the flash

- Select the channel and group of the wireless flash.

2 Set the menu

MENU →  **[Rec]** → **[Flash]**

[Wireless]	Set [Wireless] to [ON]. [WL] will appear with the flash icon on the recording screen.
[Wireless Channel]	Select the channel you have set for the wireless flash in step 1.
[Wireless Setup]	Proceed to step 3.

3 Use ▲ ▼ to select the item and press [MENU/SET]

- Ⓐ Firing Mode
- Ⓑ Flash output
- Ⓒ Flash ratio

- Press the [DISP.] button to perform a test firing.

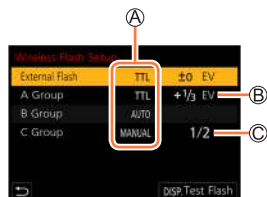

Taking Pictures with Wireless Flashes

[External Flash]*1	[Firing Mode]	[TTL]: The flash output is automatically adjusted. [AUTO]*2: Sets the flash output using an external flash. [MANUAL]: Manually sets the flash ratio of an external flash. [OFF]: The flash of this unit fires only for a communication light emission.
	[Flash Adjust.]	Adjusts the flash output of the flash of this unit manually when [Firing Mode] is set to [TTL].
	[Manual Flash Adjust.]	Sets the flash ratio of an external flash when [Firing Mode] is set to [MANUAL]. • You can set the flash ratio from [1/1] (flash firing full power) to [1/128] in 1/3 steps.
[A Group]/ [B Group]/ [C Group]	[Firing Mode]	[TTL]: The flash output is automatically adjusted. [AUTO]*1: The wireless flash automatically sets the flash output. [MANUAL]: Manually sets the flash ratio of the wireless flash. [OFF]: The wireless flashes of the set group do not fire.
	[Flash Adjust.]	Adjusts the flash output of the wireless flash manually when [Firing Mode] is set to [TTL].
	[Manual Flash Adjust.]	Sets the flash ratio of the wireless flash when [Firing Mode] is set to [MANUAL]. • You can set the flash ratio from [1/1] (flash firing full power) to [1/128] in 1/3 steps.

*1 Not available when [Wireless FP] is set to [ON].

*2 This option is not available when the flash (DMW-FL200L: optional) is attached to the camera.

■ Enabling FP firing for the wireless flashes

During wireless recording, an external flash fires an FP flash (high speed repetition of flash firing). This firing allows recording with the flash at a fast shutter speed.

MENU →  [Rec] → [Flash] → [Wireless FP]

Settings: [ON] / [OFF]

■ Setting the communication light emission to be used when wireless flash recording is performed

MENU →  [Rec] → [Flash] → [Communication Light]

Settings: [HIGH] / [STANDARD] / [LOW]

Recording Motion Picture/4K Motion Picture

Recording mode: 

You can record full high-definition quality images that comply with the AVCHD standard, as well as motion pictures recorded in MP4. You can also record a 4K motion picture in MP4. (→173)

Audio is recorded in stereo.

1 Press the motion picture button to start recording

- Ⓐ Recording state indicator
- Ⓑ Elapsed recording time
- Ⓒ Remaining recording time

- Recording of motion picture appropriate for each motion picture mode is possible.
- Immediately release the motion picture button after pressing it.
- While you are recording motion pictures, the recording status indicator (red) will flash.

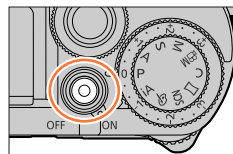

2 Press the motion picture button again to end recording

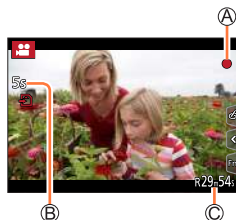

About operation sound when recording ends



If the operation sound of the motion picture button pressed to end recording bothers you, try the following:

- Record the motion picture about three seconds longer, and then divide the last part of the motion picture using [Video Divide] (→249) in the [Playback] menu.

■ Recording motion picture in Creative Video Mode

You can record a motion picture by setting the aperture, shutter speed, and ISO sensitivity using touch operation. (→89)

Recording Motion Picture/4K Motion Picture

- If the surrounding temperature is high, or a motion picture is recorded continuously, [] is displayed and recording may be stopped halfway through. Wait until the camera cools down.
- Note that if you perform operations such as zoom, using buttons or dials, while recording a motion picture, operation noise may be recorded.
- The available functions when recording a motion picture differ according to the lens used. Also, lens operation sounds and other action sounds may be recorded.
- If the aspect ratio is different for still pictures and motion pictures, the angle of view will change when starting to record a motion picture. When you set [Rec Area] to [, the angle of view setting used for recording motion pictures is displayed.
- Depending on the type of the card, the card access indication may appear for a while after recording motion pictures. This is not a malfunction.
- ISO sensitivity is set to [AUTO] (for motion pictures) while a motion picture is being recorded. You can set ISO sensitivity and record motion pictures in Creative Video Mode.
- The below-mentioned motion picture recording modes are set in the following cases:

Selected Scene Guide Mode	Recording mode at the time of recording motion pictures
[Clear in Backlight]	Portrait Mode
[Clear Nightscape], [Artistic Nightscape], [Handheld Night Shot], [Clear Night Portrait]	Low Light Mode

- This function is not available in the following cases:
 - [Glistening Water], [Glittering Illuminations], [Soft Image of a Flower] (Scene Guide Mode)
 - [Rough Monochrome], [Silky Monochrome], [Soft Focus], [Star Filter], [Sunshine] (Creative Control Mode)
 - When [Post Focus] is set
 - When using [Time Lapse Shot]
 - When using [Stop Motion Animation]

Setting the format, picture size and recording frame rate

1 Set the menu

MENU →  **[Motion Picture]** → **[Rec Format]**

[AVCHD] This is a data format suitable for playback on high-definition TVs.

[MP4] This data format is suited for playing back motion pictures on a computer and other such devices.

2 Use ▲ ▼ to select **[Rec Quality]** and press **[MENU/SET]**

When **[AVCHD]** is selected

[Rec Quality]	Picture size	Recording frame rate	Sensor output	Bit rate
[FHD/28M/50p] *1	1920×1080	50p	50 fps	28 Mbps
[FHD/17M/50i]	1920×1080	50i	50 fps	17 Mbps
[FHD/24M/25p]	1920×1080	50i	25 fps	24 Mbps
[FHD/24M/24p]	1920×1080	24p	24 fps	24 Mbps

When **[MP4]** is selected

[Rec Quality]	Picture size	Recording frame rate	Sensor output	Bit rate
[4K/100M/30p] *2	3840×2160	30p	30 fps	100 Mbps
[4K/100M/25p] *2	3840×2160	25p	25 fps	100 Mbps
[4K/100M/24p] *2	3840×2160	24p	24 fps	100 Mbps
[FHD/28M/60p]	1920×1080	60p	60 fps	28 Mbps
[FHD/28M/50p]	1920×1080	50p	50 fps	28 Mbps
[FHD/20M/30p]	1920×1080	30p	30 fps	20 Mbps
[FHD/20M/25p]	1920×1080	25p	25 fps	20 Mbps
[HD/10M/30p]	1280×720	30p	30 fps	10 Mbps
[HD/10M/25p]	1280×720	25p	25 fps	10 Mbps

*1 AVCHD Progressive

*2 4K motion pictures



Recording Motion Picture/4K Motion Picture

- The quality becomes higher when the number of bit rate gets bigger. This unit uses the “VBR” recording method, and the bit rate is changed automatically depending on the subject to record. Therefore, the recording time is shortened when a subject with fast movement is recorded.
- 4K motion picture cannot be set when using [Miniature Effect] (Creative Control Mode).
- To record 4K motion pictures, use a UHS Speed Class 3 card.
- When you record 4K motion pictures, the angle of view will be narrower than motion pictures of other sizes.
- To ensure highly accurate focus, 4K motion pictures are recorded at reduced Auto Focus speeds. It may be difficult to focus on the subject with Auto Focus, but this is not a malfunction.
- Limitations on continuous recording (→35)

■ About the compatibility of the recorded motion pictures

Motion pictures recorded in [AVCHD] or [MP4] may be played back with poor picture or sound quality or playback may not be possible even when played back with equipment compatible with these formats. Also, the recording information may not be displayed properly.

- When you play back and import motion pictures recorded with [FHD/28M/50p], [FHD/24M/25p], or [FHD/24M/24p] in [AVCHD] using a device other than this unit, a compatible Blu-ray disc recorder or PC installed with “PHOTOfunSTUDIO” software is required.
- For details on motion pictures recorded with [4K/100M/30p], [4K/100M/25p] or [4K/100M/24p] in the [MP4] format, refer to “Enjoying 4K motion pictures” (→298).



Adjusting the focus while recording motion pictures ([Continuous AF])

Recording mode:

Focusing varies depending on the setting of focus and the setting of [Continuous AF] in the [Motion Picture] menu.

MENU → **[Motion Picture]** → **[Continuous AF]**

Focus setting	[Continuous AF]	Setting
[AFS]/[AFF]/[AFC]	[ON]	Allow the focus to be constantly adjusted automatically while recording motion pictures.
	[OFF]	Fix focus position at the start of motion picture recording.
[MF]	[ON] / [OFF]	Allow the focus to be adjusted manually.

- The interchangeable lens (H-H020A) utilises a lens drive system to realize a compact and bright F1.7 lens. As a result, sound and vibration may occur during focus operation, but this is not a malfunction.
- When the focus setting is set to [AFS], [AFF], or [AFC], the camera will refocus if the shutter button is pressed halfway while recording motion pictures.
- When Auto Focus is activated while you are recording motion pictures, the focusing operation sound may be recorded under some conditions. If you want to suppress this sound, we recommend taking pictures after setting [Continuous AF] to [OFF].
- When using zoom while recording motion pictures, it may take some time to focus.
- This function is not available in the following case:
 - While [Pull Focus] in [Snap Movie] is in operation.

Taking still pictures while a motion picture is being recorded

Recording mode: **PAS** **M**

1 Press the shutter button fully during the motion picture recording

- Simultaneous recording indicator is displayed while recording still pictures.
- Recording with the Touch Shutter function is also available.



■ Setting the motion picture priority or still picture priority mode

Recording mode: **PAS** **M**

MENU → **[Motion Picture]** → **[Picture Mode in Rec.]**

<p>([Video Priority])</p>	<ul style="list-style-type: none"> • Pictures will be recorded with a picture size determined by the [Rec Quality] setting for motion pictures. • Only JPEG images are recorded when [Quality] is set to [RAW], [RAW], or [RAW]. (When set to [RAW], still pictures will be recorded in [Quality] of [].) • Up to 40 still pictures can be recorded during recording of the motion picture. (A motion picture with a [Rec Quality] size of [4K]: up to 10 pictures)
<p>([Photo Priority])</p>	<ul style="list-style-type: none"> • Pictures will be recorded with the set picture size and quality. • The screen will go dark while recording pictures. A still picture will be recorded in the motion picture during that period, and audio is not recorded. • Up to 10 still pictures can be recorded during recording of the motion picture. (A motion picture with a [Rec Quality] size of [4K]: up to 5 pictures)

- The aspect ratio of a still picture is fixed to [16:9].
- This function is not available in the following cases:
 - When [Rec Format] is set to motion picture with a frame rate of [24p] (only when [] ([Photo Priority]) is set)
 - When [4K PHOTO] is set (only when [] ([Photo Priority]) is set)
 - When setting [Ex. Tele Conv.] in the [Motion Picture] menu (only when [] ([Photo Priority]) is set)
 - When [Snap Movie] is set to [ON]

Recording Snap Movies

Recording mode: **P** **A** **S** **M**

You can specify the recording time in advance and record motion pictures casually like you take snapshots. The function also allows you to shift a focus at the start of recording and add fade in/out effects in advance.

- Motion pictures will be recorded with [FHD/20M/25p] in [MP4].
- Using the smartphone/tablet app "Panasonic Image App", you can combine motion pictures recorded with the camera. Music can be added and various editing operations can be performed when you combine them. In addition, you can send the combined motion picture to a web service. (→273)

MENU → **[Motion Picture]** → **[Snap Movie]** → **[ON]**

- Press the shutter button halfway to exit the menu.

1 Press the motion picture button to start recording

- (A) Elapsed recording time
- (B) Set recording time

- Immediately release the motion picture button after pressing it.
- You cannot stop motion picture recording in the middle. The recording will stop automatically when the set recording time has elapsed.



■ Deactivating Snap Movie

Set [Snap Movie] to [OFF].



■ Changing the settings

MENU →  **[Motion Picture]** → **[Snap Movie]** → **[SET]**

[Record time]	Sets the recording time of motion pictures.
[Pull Focus]	Allows dramatic imaging expression by shifting focus gradually at the start of recording. (→179)
[Fade]	<p>Adds a fade-in (gradual appearance) effect to an image and audio as recording starts or adds a fade-out (gradual disappearance) effect to them as recording ends.</p> <p>[WHITE-IN] / [WHITE-OUT]: Adds a fade-in or fade-out effect that uses a white screen.</p> <p>[BLACK-IN] / [BLACK-OUT]: Adds a fade-in or fade-out effect that uses a black screen.</p> <p>[COLOR-IN] / [COLOR-OUT]: Adds an effect that fades in from black-and-white to colour or an effect that fades out from colour to black-and-white. Audio will be recorded normally.</p> <p>[OFF]</p>

- Motion pictures recorded with [WHITE-IN] or [BLACK-IN] are displayed as all-white or all-black thumbnails in Playback Mode.
- If you assign [Snap Movie] to [Fn Button Set] in [Custom] ([Operation]) menu (→60), you can display a screen that lets you switch [Snap Movie] between [ON]/[OFF] by pressing the assigned function button. If you press [DISP.] button while the screen is displayed, you can change the settings for Snap Movie.
- [Snap Movie] will be set to [OFF] when you connect to Wi-Fi with [Remote Shooting & View].
- This function is not available in the following cases:
 - [Miniature Effect] (Creative Control Mode)
 - When [4K PHOTO] is set
 - When [Post Focus] is set
 - When [4K Live Cropping] is set

Setting up [Pull Focus]

Set the frames that specify the positions where the [Pull Focus] starts (first position) and stops (second position).

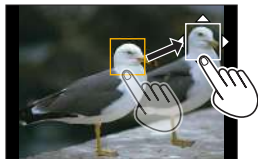





Touch operation

Touch a subject (first position), drag your finger to the desired location (second position), and release the finger.



- To cancel the frame settings, touch .

Button operation

- 1 Press .
- 2 Press     to move the frame, and press [MENU/SET] (First position)
 - If you press [DISP.] button before pressing [MENU/SET], the frame will return to the centre.
- 3 Repeat step 2 (Second position)
 - To cancel the frame settings, press [MENU/SET].



- A greater effect can be achieved by creating a striking contrast of focus between the start and end positions, for example by shifting focus from the background to foreground, or vice versa.
- After setting focus, try to keep the distance between the subject and the camera constant.

- When the camera fails to set the frame, it returns to the first position.
- When [Pull Focus] is set to [ON]
 - Auto Focus Mode will be switched to , a setting specially designed for [Pull Focus].
 - If you take a picture, the Auto Focus operation  will take place at the first frame position.
- When [Metering Mode] is set to , the spot metering target is fixed at the start position (first position) of [Pull Focus].
- This function is not available in the following cases:
 - In Manual Focus
 - When using the Digital Zoom



Viewing your pictures

1 Press [▶] (Playback) button

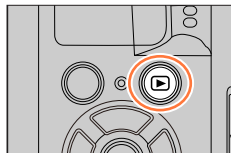

2 Press ◀▶ to select a picture to be displayed

- When you press and hold ◀▶, the pictures are displayed one after another.
- Pictures can also be forwarded or rewound by rotating the front dial or dragging the screen horizontally.
- If you keep your finger touching the left or right edge of the screen after scrolling the pictures, the pictures will continue to be scrolled. (The pictures are displayed in a reduced size.)



Sending pictures to the WEB services

If you press ▼ while a single picture is being displayed, you can send the picture to the WEB service quickly. (→286)

■ Ending Playback

Press [▶] (Playback) button again.

The Playback can also be ended by pressing the shutter button halfway.

- The playback screen appears if the camera is turned on while pressing [▶] (Playback) button.
- This camera is compliant with the unified DCF (Design rule for Camera File system) standard formulated by the Japan Electronics and Information Technology Industries Association (JEITA), and with Exif (Exchangeable image file format). Files that are not DCF-compliant cannot be played back.
- It may not be possible to properly play back pictures taken using other cameras on this unit or it may not be possible to use the functions of this unit for those pictures.



Viewing motion pictures

This unit was designed to play motion pictures using the AVCHD and MP4 formats.

- Motion pictures are displayed with the motion picture icon ([]).















1 Press to start playback

 Motion picture recording time

- Touching [] in the middle of the screen allows you to play back motion pictures.
- Motion pictures recorded with [Snap Movie] are played back automatically.
- Some information will not be displayed for motion pictures recorded in [AVCHD].





■ Operations during motion picture playback

Operation	Touch operation	Description
		Play / pause
		Fast rewind*1
		Single-frame rewind*2 (while paused)
		Fast forward*1
		Single-frame forward (while paused)
		Stop
		Volume up
		Volume down

*1 The fast forward or rewind speed increases if you press  again.

*2 Motion pictures recorded in [AVCHD] are rewound frame by frame approximately every 0.5 seconds.

■ Operations during automatic Snap Movie playback

	Playback from the beginning
	Returning to the previous picture
	Scrolling to the next picture

- If you touch the screen, automatic playback will stop.

● Motion pictures can be viewed on your computer using "PHOTOfunSTUDIO".

Capturing still pictures from motion pictures

1 Display the picture that you want to capture as a still picture by pressing ▲ to pause a motion picture being played back on the camera

- If you press ◀▶ while paused, you can make finer adjustments to the positions in a motion picture.

2 Press [MENU/SET]

- The same operation can be performed by touching [⏏].
- The still picture is saved with aspect ratio of [16:9] and [Quality] of [S]. The picture size varies depending on the motion picture being played back.



[Rec Quality]	[Picture Size]
[4K]	[M] (8M)
[FHD], [HD]	[S] (2M)

- The picture quality becomes slightly lower depending on the [Rec Quality] setting of the original motion picture.
- When a still picture captured from a motion picture is played back, [S] is displayed.



Switching the Playback Method

Zooming in and viewing “Playback Zoom”

1 Rotate the rear dial to the right

Ⓐ Current zoom position

- Each time you rotate the rear dial to the right, the magnification increases through four levels: 1x, 2x, 4x, 8x, and 16x.



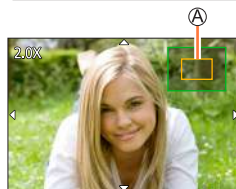
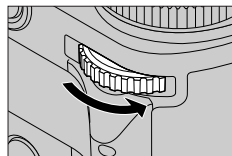

Operation	Touch operation	Description
	—	Enlarges/reduces the screen in large steps.
—	Pinch out / Pinch in	Enlarges/reduces the screen in small steps.
	Drag	Moves the enlarged area (during enlarged display).
	—	Forwards/rewinds a picture while maintaining the same zoom magnification and zoom position (during Playback Zoom).

- You can also zoom in by quickly touching the display twice. (If the display was enlarged, it returns to the same magnification ratio.)



Viewing a list of pictures “Multi Playback”

1 Rotate the rear dial to the left

- Rotate the rear dial to the left to switch the display methods in the following order: 1-picture screen (full-screen) → 12-picture screen → 30-picture screen → Calendar screen. (Rotate the dial to the right to return.)
- It is possible to switch the playback screen by touching the following icons.
 - : 1-picture screen
 - : 12-picture screen
 - : 30-picture screen
 - : Calendar screen (→184)
- The screen can be switched gradually by dragging the screen up or down.
- When you select a picture using the cursor button and press [MENU/SET] on the 12-picture or 30-picture screen, the selected picture is displayed on the 1-picture screen (full-screen). (When you select a motion picture, it is automatically played back.)

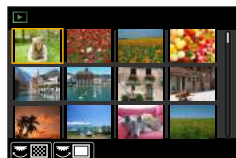
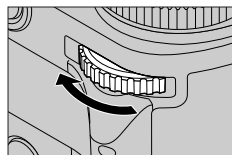

- Pictures displayed with [!] cannot be played back.

Viewing pictures by their recording date “Calendar Playback”

- 1 Rotate the rear dial to the left to display the calendar screen

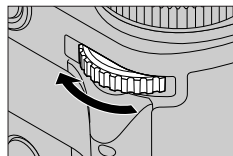

- 2 Use ▲▼◀▶ to select recording date and press [MENU/SET]

Ⓐ Selected date

- Pictures are displayed in a 12-picture screen.
- Rotate the rear dial to the left to return to the Calendar screen display.

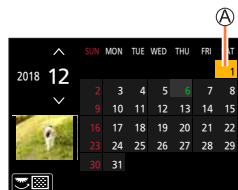

- You can display the calendar between January 2000 to December 2099.
- Pictures taken without clock settings are displayed with the date 1st January, 2018.
- Pictures taken with destination settings made in [World Time] are displayed in the calendar screen using the appropriate date for the destination's time zone.

Viewing group pictures

You can consecutively play back multiple pictures in a group or play back group pictures one by one.

[]: Group picture saved using [4K PHOTO Bulk Saving]

[]: Group pictures recorded using Focus Bracket

[]: Group pictures recorded using [Time Lapse Shot]

[]: Group pictures recorded using [Stop Motion Animation]



- You can delete or edit pictures in group units. (For example, if you delete one of pictures in a group, all pictures in that group will be deleted.)

- Pictures will not be grouped if they are recorded without setting [Clock Set].

Playing back group pictures consecutively

1 Press ▲

- The same operation can be performed by touching the group picture icon ([], [], []).
- When you play back group pictures one by one, the option settings are displayed. After you select [Burst Play] (or [Sequential Play]), select one of the following playback methods.
 - [From the first picture]: Play back the group pictures consecutively from the first picture in a group.
 - [From the current picture]: Play back the group pictures consecutively from the picture currently played back.

■ Operations during continuous playback

Operation	Touch operation	Description	Operation	Touch operation	Description
▲		Continuous playback / Pause	▼		Stop
◀		Fast rewind playback	▶		Fast forward playback
		Returning to the previous picture (while paused)			Scrolling to the next picture (while paused)

Playing back group pictures one by one

1 Press ▼

- The same operation can be performed by touching [◀] / [▶] / [◀] / [▶].

2 Use ◀▶ to scroll through the pictures



- Pressing ▼ again or touching [▶] will return you to the normal playback screen.
- You can use the same operations for pictures stored in a group as in normal still picture playback. (Multi Playback, Playback Zoom, deletion of pictures, etc.)



Deleting pictures

Deleted pictures cannot be recovered.

[Delete Single]

- 1 Press [] button to delete displayed picture
 - The same operation can be performed by touching [].

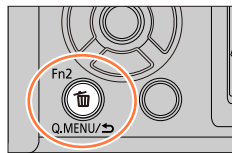

- 2 Use ▲ to select [Delete Single] and press [MENU/SET]

To delete multiple (up to 100*)/To delete all pictures

* A picture group is handled as 1 picture. (All the pictures in the selected picture group are deleted.)

- 1 Press [] button while viewing a picture
- 2 Use ▲ ▼ to select [Delete Multi]/[Delete All] and press [MENU/SET]
 - You can select [Delete All Non-rating] in [Delete All] if there are pictures that have been set as [Rating].

(When [Delete Multi] is selected)

- 3 Use ▲ ▼ ◀ ▶ to select picture and press [MENU/SET] (repeat)

 Picture selected

- To cancel → Press [MENU/SET] again.

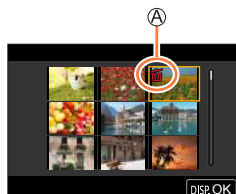

- 4 Press [DISP.] button to execute
 - May take time depending on number of pictures deleted.

Menu list

Menus to be displayed in each recording mode

[Intelligent Auto]

- [Intelligent Auto Mode] ([→64](#))
- [iHandheld Night Shot] ([→66](#))
- [iHDR] ([→67](#))

[Creative Video]

- [Exposure Mode] ([→89](#))
- [4K Live Cropping] ([→91](#))

C [Custom Mode]

You can select your preferred custom setting from [Set1], [Set2], and [Set3]. ([→94](#))

[Panorama Shot]

- [Direction] ([→77](#))
- [Picture Size] ([→77](#))

[Scene Guide]

- [Scene Switch] ([→79](#))

[Creative Control]

- [Filter Effect] ([→83](#))
- [Simultaneous Record w/o Filter] ([→83](#))

[Rec]	→189
-------	----------------------

[Motion Picture]	→205
------------------	----------------------

[Custom]	→207
----------	----------------------

[Setup]	→223
---------	----------------------

[My Menu]	→234
-----------	----------------------

[Playback]	→235
------------	----------------------

[Rec]

- The [AFS/AFF], [Photo Style], [Filter Settings], [Metering Mode], [Highlight Shadow], [i.Dynamic], [i.Resolution], [Diffraction Compensation], [Stabilizer] and [Digital Zoom] menu items are common for both [Rec] and [Motion Picture] menus. If a setting in one menu is changed, the setting with the same name in other menu will also be changed automatically.
- [Aspect Ratio] (→189)
- [Picture Size] (→190)
- [Quality] (→190)
- [AFS/AFF] (→96)
- [Photo Style] (→192)
- [Filter Settings] (→194)
- [Color Space] (→196)
- [Metering Mode] (→196)
- [Highlight Shadow] (→197)
- [i.Dynamic] (→198)
- [i.Resolution] (→198)
- [Flash] (→163 - 170)
- [Red-Eye Removal] (→198)
- [ISO Auto Upper Limit (Photo)] (→199)
- [Min. Shtr Speed] (→199)
- [Long Shtr NR] (→199)
- [Shading Comp.] (→200)
- [Diffraction Compensation] (→200)
- [Stabilizer] (→152)
- [Ex. Tele Conv.] (→156)
- [Digital Zoom] (→158)
- [Burst Rate] (→138)
- [4K PHOTO] (→120)
- [Self Timer] (→140)
- [Time Lapse Shot] (→145)
- [Stop Motion Animation] (→148)
- [Silent Mode] (→201)
- [Shutter Type] (→201)
- [Shutter Delay] (→202)
- [Bracket] (→141)
- [HDR] (→203)
- [Multi Exp.] (→204)

[Aspect Ratio]

Recording mode: **P** **A** **S** **M** **SCN**

This allows you to select the aspect ratio of the pictures to suit printing or the playback method.

MENU → **[Rec]** → **[Aspect Ratio]**

[4:3]	Aspect ratio of a 4:3 TV
[3:2]	Aspect ratio of standard film cameras
[16:9]	Aspect ratio of high-definition TV, etc.
[1:1]	Aspect ratio of a square image



[Picture Size]Recording mode: **P** **A** **S** **M**

The higher the numbers of pixels, the finer the detail of the pictures will appear even when they are printed onto large sheets.

MENU → [Rec] → [Picture Size]

[Aspect Ratio]	4:3	3:2	16:9	1:1
[Picture Size]	[L] 20M 5184×3888	[L] 17M 5184×3456	[L] 14.5M 5184×2920	[L] 14.5M 3888×3888
	[EX M] 10M 3712×2784	[EX M] 9M 3712×2480	[EX M] 8M 3840×2160	[EX M] 7.5M 2784×2784
	[EX S] 5M 2624×1968	[EX S] 4.5M 2624×1752	[EX S] 2M 1920×1080	[EX S] 3.5M 1968×1968

- When [Ex. Tele Conv.] ([Rec]) is set, [EX] is displayed on the picture sizes of each aspect ratio except for [L].
- The picture size will be fixed to [4K] when recording 4K photos or recording in [Post Focus].

[Quality]Recording mode: **P** **A** **S** **M**

Set the compression rate used for storing pictures.

MENU → [Rec] → [Quality]

Settings	File format	Description
	JPEG	Gives priority to picture quality and saves pictures in JPEG file format.
		Saves pictures in JPEG file format using standard picture quality. This setting is useful when you want to increase the number of recordable pictures without changing the number of pixels.
[RAW	RAW + JPEG	Saves pictures in both RAW and JPEG file format ([] or []) simultaneously.
[RAW		
[RAW]	RAW	Saves pictures in RAW file format.



About RAW file

In RAW file format the data is saved without any picture processing by the camera. To play back and edit RAW file pictures, you must use this unit or dedicated software.

- You can develop the RAW file pictures using [RAW Processing] in the [Playback] menu. (→240)
- To develop and edit RAW file pictures on a PC, use the software (Ichikawa Soft Laboratory's "SILKYPIX Developer Studio"). To get this software, download it from the supplier's website and install it on your PC. (→306)

- A RAW still picture is always recorded at [4:3] (5184×3888).
- If you delete a picture recorded in [RAW] or [RAW] from the camera, the corresponding RAW and JPEG pictures are also deleted.
- When you play back a picture recorded with [RAW], the grey area is displayed according to the aspect ratio of the picture during recording.
- The setting is fixed to [4:3] when recording 4K photos or recording in [Post Focus].
- You cannot set to [RAW], [RAW] or [RAW] in the following cases:
 - Panorama Shot Mode
 - [Handheld Night Shot] (Scene Guide Mode)



[Photo Style]

Recording mode: **P** **A** **S** **M** **SCN**

You can adjust the colours and picture quality according to the concept of the picture that you want to create.

MENU → **[Rec]** → **[Photo Style]**

STD. [Standard]	Standard setting.
VIVID [Vivid]*	Setting with slightly high contrast and saturation.
NAT [Natural]*	Setting with slightly low contrast.
MONO [Monochrome]	Setting that creates a picture using monochrome shades of grey only, such as black and white.
L.MONO [L.Monochrome]*	Setting that creates a monochrome picture using rich shades of grey with deep solid black tones.
L.MONO D [L.Monochrome D]*	Setting that creates a dynamic monochrome picture with emphasised highlights and shadows.
SCNY [Scenery]*	Setting that creates a picture using vivid colours for the blue sky and green.
PORT [Portrait]*	Setting that produces the look of a healthy complexion.
CUST [Custom]*	Setting for using colours and picture quality that were registered in advance.

* This setting is not available in Intelligent Auto Plus Mode.

- In Intelligent Auto Plus Mode, the setting will be reset to [Standard] when the camera is switched to another Recording mode or this unit is turned on and off.
- Only picture quality adjustment can be set in the Scene Guide Mode. (→193)



■ Adjusting the picture quality

- Picture quality cannot be adjusted in the Intelligent Auto Plus Mode.

- ① Press ◀▶ to select the type of Photo Style
- ② Press ▲▼ to select an item and press ◀▶ to adjust

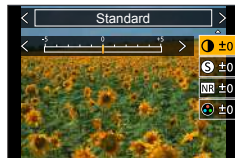

ⓘ [Contrast]	[+]	Increases the contrast in a picture.
	[-]	Decreases the contrast in a picture.
S [Sharpness]	[+]	Enhances the outlines in a picture.
	[-]	Softens the outlines in a picture.
NR [Noise Reduction]	[+]	Increases the noise reduction effect to reduce noise. This setting may slightly lower the resolution.
	[-]	Lowers the noise reduction effect to achieve a picture quality with clearer resolution.
🌈 [Saturation]*1	[+]	Gaudy colouring
	[-]	Subdued colouring
🌈 [Color Tone]*1	[+]	Bluish colouring
	[-]	Yellowish colouring
🎯 [Filter Effect]*2	[Yellow]	Enhances the contrast of a subject. (Effect: Low) Records a blue sky clearly.
	[Orange]	Enhances the contrast of a subject. (Effect: Medium) Records a blue sky with vibrant colours.
	[Red]	Enhances the contrast of a subject. (Effect: High) Records a blue sky with even more vibrant colours.
	[Green]	Applies subdued colouring for the skin and lips of a person. Emphasises green leaves and makes them brighter.
	[Off]	—
🎨 [Grain Effect]*2	[Low]/ [Standard]/ [High]	Sets the graininess in a picture.
	[Off]	—

*1 [Color Tone] is displayed only when [Monochrome], [L.Monochrome] or [L.Monochrome D] is selected. Otherwise, [Saturation] is displayed.

*2 Displayed only when [Monochrome], [L.Monochrome] or [L.Monochrome D] is selected.

- When the picture quality is adjusted, [+] will be displayed in the [Photo Style] icon.

- ③ Press [MENU/SET]

■ Registering the setting for the adjusted picture quality to [Custom]

① Perform the picture quality adjustment in Step ② of “Adjusting the picture quality” and press the [DISP.] button

- The [Grain Effect] setting is not applied to the recording screen.
- [Grain Effect] is not available in the following cases.
 - Panorama Shot Mode
 - When recording motion pictures
 - When recording 4K photos
 - When recording using [Post Focus]

[Filter Settings]

Recording mode:

You can apply picture effects (filters) that are available for Creative Control Mode to images in other modes, such as Aperture-Priority AE Mode or Panorama Shot Mode.

(→83)

MENU → **[Rec]** → **[Filter Settings]** → **[Filter Effect]**

Settings: [ON] / [OFF] / [SET]

■ With touch screen operations

- ① Touch
- ② Touch the item you want to set
 - : Picture effects ON or OFF
 - [EXPS]: Picture effects (Filter)
 - : Adjusting the picture effect





- [Rough Monochrome], [Silky Monochrome], [Soft Focus], [Star Filter] and [Sunshine] are not available in the following cases.
 - Creative Video Mode
 - During motion picture recording
- The following functions are not available in Panorama Shot Mode.
 - [Toy Effect], [Toy Pop], [Miniature Effect], [Sunshine]
- When recording panorama pictures, the following effects are not applied to the recording screen.
 - [Rough Monochrome], [Silky Monochrome], [Soft Focus], [Star Filter]
- When recording a panorama picture in a scene with low brightness, you may not be able to achieve the desired results if [High Key] is used in the Panorama Shot Mode.
- The available ISO sensitivity settings will be limited up to [3200].
- The ISO sensitivity for [High Dynamic] will be fixed to [AUTO].
- When using [Filter Effect], you cannot use menus or recording functions which are not available in Creative Control Mode.
- This function is not available in the following case:
 - When recording using [4K Live Cropping]

■ Taking two still pictures with and without picture effects ([Simultaneous Record w/o Filter])

You can take two still pictures at the same time by pressing the shutter button once; one with effects and one without effects.

MENU →  **[Rec]** → **[Filter Settings]** → **[Simultaneous Record w/o Filter]**

Settings: [ON] / [OFF]

- The camera will take a still picture with the effects applied and then a still picture without the effects.
 - After taking the picture, [Auto Review] will display only the still picture with the effects applied.
- This function is not available in the following cases:
 - Panorama Shot Mode
 - When using [Burst]
 - When recording 4K photos
 - When recording using [Post Focus]
 - Taking still pictures while a motion picture is being recorded (only when  ([Video Priority]) is set)
 - When [Quality] is set to [RAW , [RAW ] or [RAW]
 - When recording using [Bracket]
 - When using [Time Lapse Shot]
 - When using [Stop Motion Animation]

[Color Space]

Recording mode: **P** **A** **S** **M**

You can set the method for reproducing the colours to correctly display the recorded pictures on the screens of a PC or printer, etc.

MENU → **[Rec]** → **[Color Space]**

[sRGB]	Sets the sRGB colour space. This setting is widely used for devices such as PCs.
[AdobeRGB]	Sets the AdobeRGB colour space. AdobeRGB colour space has a wider colour reproduction range than sRGB colour space. Therefore, AdobeRGB colour space is mainly used for business applications such as commercial printing.

- Select [sRGB] if you do not have expert knowledge about AdobeRGB colour space.
- The setting is fixed to [sRGB] while recording motion pictures, recording 4K photos, or recording in [Post Focus].

[Metering Mode]

Recording mode: **P** **A** **S** **M**

You can change the metering method used for measuring brightness.

MENU → **[Rec]** → **[Metering Mode]**

[Metering Mode]	Brightness measurement position	Conditions
 (Multiple)	Whole screen	Normal usage (produces balanced pictures)
 (Centre weighted)	Centre and surrounding area	Subject in centre
 (Spot)	Centre of [+] (spot metering target) 	Great difference between brightness of subject and background (e.g. person in spotlight on stage, backlighting)

- If you set the spot metering target on the edge of the screen, the metering may be affected by the brightness around the location.



[Highlight Shadow]

Recording mode:

You can adjust the highlights and shadows in a picture while confirming the brightness of these areas on the screen.

1 Set the menu

MENU → **[Rec]** → **[Highlight Shadow]**

<input type="checkbox"/> [(Standard)]	No adjustments.
<input type="checkbox"/> [(Higher contrast)]	Makes the highlighted areas brighter and shadowed areas darker.
<input type="checkbox"/> [(Lower contrast)]	Makes the highlighted areas darker and shadowed areas brighter.
<input type="checkbox"/> [(Brighten shadows)]	Makes the shadowed areas brighter.
<input type="checkbox"/> [C1] / [C2] / [C3] (Custom)	You can set a custom registration shape.

2 Rotate the front dial to adjust the brightness of the highlighted areas and rotate the rear dial to adjust the brightness of the shadowed areas

- Ⓐ Highlighted area
- Ⓑ Shadowed area
- Ⓒ Preview display

- Adjustments can also be made by dragging the graph.
- To register your preferred settings, press to select the registration target icon (Custom 1, Custom 2, and Custom 3).

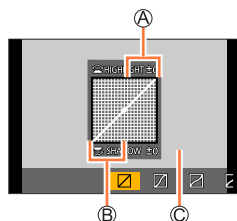

3 Press [MENU/SET]

- You can press the [DISP.] button on the brightness adjustment screen to switch the screen display.

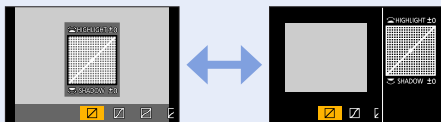

- The settings adjusted in , , , or will be restored to the default settings when the camera is turned off.

[i.Dynamic]

Recording mode: **PAS**

Automatically adjusts contrast and exposure to give more lifelike colours when there is significant contrast between background and subject.

MENU → **[Rec]** → **[i.Dynamic]**

Settings: **[AUTO]** / **[HIGH]** / **[STANDARD]** / **[LOW]** / **[OFF]**

- You may not see the effect depending on the recording conditions.
- This function is not available in the following case:
 - When **[HDR]** is set to **[ON]**

[i.Resolution]

Recording mode: **PAS**

You can use the camera's Intelligent Resolution technology to record still pictures with sharper outlines and clearer resolution.

MENU → **[Rec]** → **[i.Resolution]**

Settings: **[HIGH]** / **[STANDARD]** / **[LOW]** / **[OFF]**

[Red-Eye Removal]

Recording mode: **PAS**

Automatically detects red-eye and corrects still picture data when recording with flash red-eye reduction (**[⚡Ⓞ]** or **[⚡Ⓞ]**).

MENU → **[Rec]** → **[Red-Eye Removal]**

Settings: **[ON]** / **[OFF]**

- When this function is set to **[ON]**, the flash icon changes to **[⚡Ⓞ]**/**[⚡Ⓞ]**.
- Depending on the circumstance, it may not be possible to correct red-eye.

[ISO Auto Upper Limit (Photo)]

Recording mode: **P** **A** **S** **M**

You can set the upper limit of ISO sensitivity when ISO sensitivity is set to [AUTO] or [ISO].

MENU → **[Rec]** → **[ISO Auto Upper Limit (Photo)]**

Settings: [AUTO] / [400] / [800] / [1600] / [3200] / [6400] / [12800] / [25600]

- This function is not available in the following case:
 - [Clear Nightscape], [Cool Night Sky], [Warm Glowing Nightscape], [Handheld Night Shot] (Scene Guide Mode)

[Min. Shtr Speed]

Recording mode: **P** **A** **S** **M**

Sets the minimum value for the shutter speed to be used when ISO sensitivity is set to [AUTO] or [ISO].

MENU → **[Rec]** → **[Min. Shtr Speed]**

Settings: [AUTO] / [1/16000] to [1/1]

- The shutter speed may be slower than the setting value under recording conditions in which the correct exposure is not achieved.

[Long Shtr NR]

Recording mode: **P** **A** **S** **M**

The camera can automatically eliminate the noise made when taking pictures with a slower shutter speed (e.g. to record night scenes).

MENU → **[Rec]** → **[Long Shtr NR]**

Settings: [ON] / [OFF]

- While the camera eliminates the noise, [Long shutter noise reduction ongoing] is displayed for the same period as the shutter speed for the signal processing time.
- This function is not available in the following cases:
 - During motion picture recording
 - When recording 4K photos
 - When recording using [Post Focus]
 - When using the electronic shutter

[Shading Comp.]

Recording mode: **PAS** **M**

When the screen periphery darkens as a result of the lens characteristics, you can record pictures with the brightness of the screen periphery corrected.

MENU → **[Rec]** → **[Shading Comp.]**

Settings: **[ON]** / **[OFF]**

- Compensation effect may not be achieved depending on the recording conditions.
- Noise in the periphery of the picture may stand out with higher ISO sensitivity.
- Correction is not possible in the following cases:
 - During motion picture recording
 - Taking still pictures while a motion picture is being recorded (only when ([Video Priority]) is set)
 - When recording 4K photos
 - When recording using [Post Focus]
 - When using [Ex. Tele Conv.] ([Rec])
 - When using the Digital Zoom

[Diffraction Compensation]

Recording mode: **PAS** **M**

The camera raises the resolution by correcting the blurriness caused by diffraction when the aperture is closed.

MENU → **[Rec]** → **[Diffraction Compensation]**

Settings: **[AUTO]** / **[OFF]**

- Noise in the periphery of the picture may stand out with higher ISO sensitivity.

[Silent Mode]

Recording mode: **P** **A** **S** **M**

Disabling the beeps and flash at the same time.

MENU → **[Rec]** → **[Silent Mode]**

Settings: [ON] / [OFF]

- This mode will mute beeps, set the flash to (Forced Flash Off), and disable AF Assist Lamp.

The settings for the following functions are fixed:

- [Flash Mode]: (Forced Flash Off)
- [Shutter Type]: [ESHTR]
- [AF Assist Lamp]: [OFF]
- [Beep Volume]: (Off)
- [Shutter Vol.]: (Off)

- Even when this mode is set to [ON], the following lamps/indicators will light or flash.
 - Self-timer indicator
 - WIRELESS connection lamp
- The operation sounds of this camera such as the lens aperture sound are not muted.

[Shutter Type]

Recording mode: **P** **A** **S** **M**

You can take pictures using two types of shutter modes: the mechanical shutter and electronic shutter.

	Mechanical shutter	Electronic shutter
Flash	○	–
Shutter Speed (seconds)	T (Time)* ¹ , 60 - 1/4000	1* ² - 1/16000
Shutter sound	Mechanical shutter sound	Electronic shutter sound* ³

*¹ This setting is available only in Manual Exposure Mode.

*² When the ISO sensitivity is higher than [ISO3200], the shutter speed is faster than 1 second.

*³ You can use [Shutter Vol.] and [Shutter Tone] to adjust the volume of the electronic shutter sound. (→225)

MENU →  **[Rec]** → **[Shutter Type]**

[AUTO]	The shutter mode automatically switches based on the recording conditions and shutter speed. <ul style="list-style-type: none"> The mechanical shutter mode has higher priority over the electronic shutter mode because the mechanical shutter has less function-related restrictions when recording with a flash, etc.
[MSHTR]	Uses only the mechanical shutter mode to take a picture.
[ESHTR]	Uses only the electronic shutter mode to take a picture.

- When [E] is displayed on the screen, recording is performed with an electronic shutter.
- If you take a picture of a moving subject using the electronic shutter, the subject in the picture may be skewed in some cases.
- When you take a picture under a fluorescent or LED lighting fixture using the electronic shutter, the recorded picture may have horizontal stripes. If you use a slower shutter speed, the horizontal stripes may be reduced.

[Shutter Delay]
Recording mode:   **PAS**    

To reduce the influence of hand shake or shutter vibration, shutter is released after the specified time has passed.

MENU →  **[Rec]** → **[Shutter Delay]**
Settings: **[8SEC]** / **[4SEC]** / **[2SEC]** / **[1SEC]** / **[OFF]**

- This function is not available in the following cases:
 - When recording motion pictures
 - When recording 4K photos
 - When recording using [Post Focus]
 - When [HDR] is set to [ON]



[HDR]

Recording mode: **PAS** **M**

The camera can combine 3 still pictures taken at different exposures into a single properly exposed picture with rich gradation. The individual pictures used to create the HDR picture are not saved. You can minimise the loss of gradations in bright areas and dark areas when, for example, the contrast between the background and the subject is large.

A combined HDR picture is saved in JPEG format.

MENU → **[Rec]** → **[HDR]**

Settings: **[ON]** / **[OFF]** / **[SET]**

■ Changing the settings

[Dynamic Range]	<p>[AUTO]: Takes pictures after automatically setting the adjustment range of the exposure based on the contrast of a subject.</p> <p>[±1EV] / [±2EV] / [±3EV]: Takes pictures using the adjustment range of the exposure being set.</p>
[Auto Align]	<p>[ON]: Automatically adjusts the displacement of pictures caused by jitter, etc. We recommend using this setting to take pictures with a handheld camera.</p> <p>[OFF]: Does not adjust the displacement of pictures. We recommend using this setting when you use a tripod.</p>

- After the shutter button has been pressed, do not move the camera during the burst operation.
- Since a burst of still pictures are combined after they have been recorded, it will be a few moments before you will be able to record another picture.
- A subject that was in motion when it was recorded may be recorded as an afterimage.
- When [Auto Align] is set to [ON], the angle of view narrows slightly.
- When you take pictures using a flash, the flash mode is fixed to (Forced Flash Off).
- This function will not work for still pictures while motion pictures are being recorded.
- This function is not available in the following cases:
 - When using [Burst]
 - When recording 4K photos
 - When recording using [Post Focus]
 - When recording using [Bracket]
 - When [Quality] is set to or or [RAW]
 - When using [Time Lapse Shot]
 - When [Auto Shooting] of [Stop Motion Animation] is set to [ON]



[Multi Exp.]

Recording mode: **PAS** **M**

You can create an effect similar to the operation of up to four times of exposure on a single picture.

MENU → **[Rec]** → **[Multi Exp.]**

1 Press ▲ to select [Start] and press [MENU/SET]**2 Decide on your composition and take the first picture**

- After recording the first picture, press the shutter button halfway to proceed to the next recording.
- Press ▲▼ to select the item and press [MENU/SET]. You can perform the following operations.
 - [Next]: Proceed to the next recording.
 - [Retake]: Delete the result of the last shot and take another picture.
 - [Exit]: Exit Multi Exposure and save the picture that was taken.

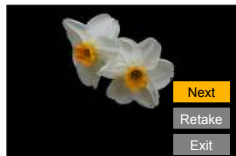
**3 Record the second, third, and fourth pictures**

- When you press [Fn2] button while taking pictures, the pictures that you took are saved and Multi Exposure is closed.

4 Press ▼ to select [Exit] and press [MENU/SET]

- You can also end the operation by pressing the shutter button halfway.

**■ Changing the settings**

[Auto Gain]	If you select [OFF], all exposure results are superimposed as they are. Compensate the exposure as necessary, depending on the subject.
[Overlay]	If you select [ON], you can apply Multi Exposure to previously recorded pictures. After [Start] is selected, pictures on the card will be displayed. Select a RAW image, and press [MENU/SET] to proceed to recording.

- Information for the picture taken last will be used as recording information of pictures taken using Multi Exposure.
- You can perform [Overlay] on RAW file pictures recorded using this camera only.
- This function is not available in the following cases:
 - When using [Time Lapse Shot]
 - When using [Stop Motion Animation]

[Motion Picture]

- The [AFS/AFF], [Photo Style], [Filter Settings], [Metering Mode], [Highlight Shadow], [i.Dynamic], [i.Resolution], [Diffraction Compensation], [Stabilizer] and [Digital Zoom] menu items are common for both [Rec] and [Motion Picture] menus. If a setting in one menu is changed, the setting with the same name in other menu will also be changed automatically. For details, refer to the corresponding item of the [Rec] menu.
- [Rec Format] (→173)
- [Rec Quality] (→173)
- [Snap Movie] (→177)
- [Continuous AF] (→175)
- [ISO Auto Upper Limit (Video)] (→90)
- [Flkr Decrease] (→205)
- [Ex. Tele Conv.] (→156)
- [Picture Mode in Rec.] (→176)
- [Sound Rec Level Disp.] (→205)
- [Sound Rec Level Adj.] (→205)
- [Wind Noise Canceller] (→206)

[Flkr Decrease]

Recording mode: **PAS**M

The shutter speed can be fixed to reduce the flicker or striping in the motion picture.

MENU → **[Motion Picture]** → **[Flkr Decrease]**

Settings: [1/50] / [1/60] / [1/100] / [1/120] / [OFF]

[Sound Rec Level Disp.]

Recording mode: **PAS**M

The sound recording level is displayed on the recording screen.

MENU → **[Motion Picture]** → **[Sound Rec Level Disp.]**

Settings: [ON] / [OFF]

[Sound Rec Level Adj.]

Recording mode: **PAS**M

Adjust the sound input level to 4 different levels (−12 dB to +6 dB).

MENU → **[Motion Picture]** → **[Sound Rec Level Adj.]**

- Displayed dB values are approximate.



[Wind Noise Canceller]**Recording mode:**   **PAS** **M**   

This will reduce the wind noise coming into the built-in microphone while maintaining sound quality.

MENU →  **[Motion Picture]** → **[Wind Noise Canceller]****Settings:** **[HIGH]** / **[STANDARD]** / **[OFF]**

- **[HIGH]** effectively reduces the wind noise by minimising the low-pitched sound when a strong wind is detected.
 - **[STANDARD]** extracts and reduces only the wind noise without deteriorating the sound quality.
- You may not see the full effect depending on the recording conditions.



[Custom] **[Exposure]**

- [ISO Increments] (→208)
- [Extended ISO] (→208)
- [Exposure Comp. Reset] (→208)

 **[Focus / Release Shutter]**

- [AF/AE Lock] (→111)
- [AF/AE Lock Hold] (→208)
- [Shutter AF] (→208)
- [Half Press Release] (→208)
- [Quick AF] (→208)
- [Eye Sensor AF] (→209)
- [Pinpoint AF Setting] (→209)
- [AF Assist Lamp] (→209)
- [Direct Focus Area] (→210)
- [Focus/Release Priority] (→210)
- [Focus Switching for Vert / Hor] (→210)
- [Loop Movement Focus Frame] (→211)
- [AF Area Display] (→211)
- [AF+MF] (→211)
- [MF Assist] (→212)
- [MF Assist Display] (→212)

 **[Operation]**

- [Fn Button Set] (→60)
- [Q.MENU] (→59)
- [Dial Set.] (→49)
- [Operation Lock Setting] (→213)
- [Video Button] (→213)
- [Touch Settings] (→213)
- [Dial Guide] (→213)

 **[Monitor / Display]**

- [Auto Review] (→214)
- [Monochrome Live View] (→214)
- [Constant Preview] (→214)
- [Live View Boost] (→215)
- [Peaking] (→215)
- [Histogram] (→216)
- [Guide Line] (→216)
- [Center Marker] (→216)
- [Highlight] (→217)
- [Zebra Pattern] (→217)
- [Expo.Meter] (→218)
- [MF Guide] (→218)
- [LVF/Monitor Disp. Set] (→50)
- [Monitor Info. Disp.] (→51)
- [Rec Area] (→218)
- [Remaining Disp.] (→218)
- [Menu Guide] (→218)

 **[Lens / Others]**

- [Lens Position Resume] (→219)
- [Power Zoom Lens] (→159)
- [Lens Fn Button Setting] (→219)
- [Self Timer Auto Off] (→219)
- [Face Recog.] (→219)
- [Profile Setup] (→222)



MENU →  [Custom] →  [Exposure]

[ISO Increments]

You can change the setting to increase ISO sensitivity by 1 EV or 1/3 EV.

[Extended ISO]

You can extend the numeric values that can be set for ISO Sensitivity. (→114)

[Exposure Comp. Reset]

If the recording mode is changed or the camera is turned off, the exposure compensation value setting is reset.

MENU →  [Custom] →  [Focus / Release Shutter]

[AF/AE Lock Hold]

Focus and exposure stays locked even if you press and release the [AF/AE LOCK] button (or the function button where [AF/AE LOCK] is registered). Press the button again to cancel the lock.

[Shutter AF]

Set whether or not the focus is adjusted automatically when the shutter button is pressed halfway.

[Half Press Release]

The shutter will immediately fire when the shutter button is pressed halfway.

[Quick AF]

The focus is automatically adjusted when camera blurring is small even when the shutter button is not pressed. (Increases battery consumption.)

- This function is not available in the following cases:
 - Preview Mode
 - When the lighting is low

MENU →  **[Custom]** →  **[Focus / Release Shutter]**

[Eye Sensor AF]

Adjusts the focus automatically when the eye sensor is activated.

- [Eye Sensor AF] may not work when the lighting is low.

[Pinpoint AF Setting]

[Pinpoint AF Time]	Sets the time for which the screen is enlarged when the shutter button is pressed halfway with Auto Focus Mode set to [+] .
[Pinpoint AF Display]	Sets whether to display the enlarged screen that appears when Auto Focus Mode is set to [+] in a window or full screen.

[AF Assist Lamp]







Illuminates the AF Assist Lamp when the shutter button is pressed halfway when it is too dark to facilitate focusing.

- The effective range of the AF Assist Lamp is different depending on the lens used.
 - When the interchangeable lens (H-FS12032) is attached and at Wide:
Approx. 1.0 m (3.3 feet) to 3.0 m (9.8 feet)
 - When the interchangeable lens (H-FS35100) is attached and at Wide:
Approx. 1.0 m (3.3 feet) to 3.0 m (9.8 feet)
 - When the interchangeable lens (H-FS12060) is attached and at Wide:
Approx. 1.0 m (3.3 feet) to 3.0 m (9.8 feet)
 - When the interchangeable lens (H-FS1442A) is attached and at Wide:
Approx. 1.0 m (3.3 feet) to 3.0 m (9.8 feet)
 - When the interchangeable lens (H-H020A) is attached:
Approx. 1.0 m (3.3 feet) to 5.0 m (16 feet)
 - When the interchangeable lens (H-FS14140) is attached and at Wide:
Approx. 1.0 m (3.3 feet) to 3.0 m (9.8 feet)
- Remove the lens hood.
- The AF Assist Lamp gets slightly blocked when the interchangeable lens (H-FS12032/H-FS35100/H-FS12060/H-FS1442A/H-H020A/H-FS14140) is used, but it does not affect the performance.
- The AF Assist Lamp may be greatly blocked, and it may become harder to focus when a lens with large diameter is used.
- The setting is fixed to [OFF] in the following cases:
 - [Distinct Scenery], [Bright Blue Sky], [Romantic Sunset Glow], [Vivid Sunset Glow], [Glistening Water], [Clear Nightscape], [Cool Night Sky], [Warm Glowing Nightscape], [Artistic Nightscape], [Handheld Night Shot] (Scene Guide Mode)
 - When [Silent Mode] is set to [ON]

MENU →  **[Custom]** →  **[Focus / Release Shutter]**

[Direct Focus Area]

Moves the AF area or MF assist using the cursor button while recording.

- When , , , or  is selected, you can move the AF area, when  is selected, you can move the lock start position, and when  is selected, you can move the focus position.
- Perform the setting of functions assigned to the cursor buttons using the Quick menu (→58) or function buttons (→60).
- [Direct Focus Area] is fixed to [OFF] in the following cases:
 - [Glistening Water] (Scene Guide Mode)
 - Creative Control Mode
 - When recording using [4K Live Cropping]

[Focus/Release Priority]

You can set whether to give higher priority to focusing or shutter release timing when you take pictures using Auto Focus mode.

You can set the priority for each focus mode ([AFS/AFF], [AFC]) separately.

[FOCUS]	No picture is taken unless focusing is achieved.
[BALANCE]	A picture is taken with an appropriate balance between focusing and shutter release timing.
[RELEASE]	A picture is taken even if the subject is out of focus.

[Focus Switching for Vert / Hor]

The camera saves the focus positions of a picture separately when it is recorded by holding the camera vertically and horizontally. The camera saves the following positions of the picture taken the previous time.

- AF area position (When ,  and  are set)
- Position displayed by MF Assist





MENU →  **[Custom]** →  **[Focus / Release Shutter]**

[Loop Movement Focus Frame]

You can move a focus area from one edge to the opposite edge of the screen in a loop when the AF area position or MF Assist area display position is set.

[AF Area Display]

You can perform the AF area display setting when the Auto Focus Mode is set to  (49-area-focusing) or Custom Multi.

[ON]	<p>Displays the AF area on the recording screen.</p> <ul style="list-style-type: none"> When the default AF area is selected in  (49-area-focusing) or , , or  of Custom Multi-function, the AF area is not displayed.
[OFF]	<p>Displays the AF area on the recording screen for only a few seconds after the AF area is set.</p>

- The [ON] setting operates as [OFF] in the following cases.
 - When recording motion pictures
 - Creative Video Mode
 - When recording 4K photos

[AF+MF]

You can manually perform fine focusing during AF Lock (pressing the shutter button halfway when the focus mode is set to [AFS] or setting AF Lock using the [AF/AE LOCK]).







MENU →  **[Custom]** →  **[Focus / Release Shutter]**

[MF Assist]

Sets the display method of MF Assist (enlarged screen).

- Available settings vary depending on the lens used.

When an interchangeable lens having a focus ring (H-FS35100/H-FS12060/H-FS1442A/H-H020A/H-FS14140) is used

	The screen is enlarged by operating the lens or by pressing [] button (◀).
	The screen is enlarged by operating the lens.
	The screen is enlarged by pressing [] button (◀).
[OFF]	The screen is not be enlarged.

When an interchangeable lens with no focus ring (H-FS12032) is used

Settings: [ON] / [OFF]

- MF Assist is not displayed in the following cases:
 - During motion picture recording
 - When recording with [] ([4K Pre-Burst]) of the 4K Photo function
 - When using the Digital Zoom

[MF Assist Display]

Sets whether to display the MF Assist (enlarged screen) in a window or full screen.



MENU →  [Custom] →  [Operation]

[Operation Lock Setting]

You can set an object for which operation is disabled when [Operation Lock] is assigned to the function button using [Fn Button Set] (→60) in the [Custom] ([Operation]) menu.

[Cursor]	Disables the operation of the cursor button and [MENU/SET] button.
[Touch Screen]	Disables the touch operation using the touch panel.

[Video Button]

Enabling/disabling the motion picture button.

[Touch Settings]

Enabling/disabling the touch operation.



[Touch Screen]	All touch operations.
[Touch Tab]	Operations of tabs, such as [] displayed on the right side of the screen.
[Touch AF]	Operation to optimise the focus [AF] or both the focus and brightness [AF+AE] for a touched subject.
[Touch Pad AF]	Operation to move the AF area by touching the monitor when the viewfinder is in use. (→106)

[Dial Guide]

Enabling/disabling the operation guide display when switching recording modes (active when [Exposure Dial] (→49) is set to [OFF]).



Example

MENU →  **[Custom]** →  **[Monitor / Display]**

[Auto Review]

[Duration Time (photo)]	Set the time to display the pictures you have taken after taking still pictures.
[Duration Time (4K PHOTO)]	Set whether to display the pictures you have taken after recording 4K photos.
[Duration Time (Post Focus)]	Set whether to display the pictures you have taken after recording using [Post Focus].
[Playback Operation Priority]	Allows you to switch the playback screen or to delete pictures when the [Auto Review] function is activated.

- When [Duration Time (photo)] is set to [HOLD], pictures are displayed until you press the shutter button halfway. In this case, [Playback Operation Priority] is fixed to [ON].
- When [Grain Effect] is selected for [Photo Style], [Auto Review] is not displayed during [Time Lapse Shot] and [Stop Motion Animation] recording.

[Monochrome Live View]



You can display the recording screen in black and white. This function is useful when a black and white screen will make it easier to adjust focus in Manual Focus mode.

- When using the HDMI output during recording, the image is not displayed in black and white.
- This does not affect recorded pictures.

[Constant Preview]

You can check the effects of the chosen aperture and shutter speed on the recording screen in Manual Exposure Mode.

- This function is disabled when the flash is used.

MENU →  [Custom] →  [Monitor / Display]

[Live View Boost]

The screen is displayed bright so that you can check the composition in low-light environment such as at night.

- Select [SET] to specify the Recording Mode in which [Live View Boost] will be enabled.
- Noise may be more noticeable in the screen than in the recorded image.
- This function is disabled in the following cases:
 - When adjusting the exposure (when the shutter button is pressed halfway, for example)
 - When recording a motion picture or 4K photo
 - When an image effect in [Filter Effect] of [Filter Settings] is set
 - When using [Constant Preview]



[Peaking]

When you perform Manual Focus operation, this function automatically adds colour to the portions of the image that are in Focus (portions on the screen with clear outlines).

- When [Detect Level] in [SET] is set to [HIGH], portions to be highlighted are reduced, allowing you to achieve a more precise focus.
- Changing the [Detect Level] setting also changes the [Display Color] setting as follows.

[Detect Level]	[HIGH]	↔	[LOW]
	 (Light blue)	↔	 (Blue)
	 (Yellow)	↔	 (Orange)
[Display Color]	 (Yellow Green)	↔	 (Green)
	 (Pink)	↔	 (Red)
	 (White)	↔	 (Grey)

- Each time [PEAK] in [] is touched, the setting is switched in order of [PEAK L] ([Detect Level]: [LOW]) → [PEAK H] ([Detect Level]: [HIGH]) → [OFF].
- [Peaking] is not available when using [Live View Boost].
- This function is not available in the following case:
 - [Rough Monochrome] (Creative Control Mode)

MENU →  [Custom] →  [Monitor / Display]

[Histogram]

Enabling/disabling the histogram display.

When set to [ON], you can move the display position of the histogram by pressing ▲▼◀▶.

- Direct touch operation is also possible from the recording screen.

Displays distribution of brightness in picture – e.g. if the graph peaks at the right, this means there are several bright areas in the picture. A peak in the centre represents correct brightness (correct exposure). This can be used as a reference for exposure correction, etc.

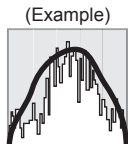



Dark ← OK → Bright

- **When the histogram is not the same as that of the recorded picture under the following conditions, histogram will be displayed in orange:**
 - During Exposure Compensation.
 - When the flash fires.
 - When the correct exposure is not achieved, such as when the lighting is low.



[Guide Line]

Sets the pattern of the guidelines to be displayed while recording.

- When you select , you can move the position of the guideline by pressing ▲▼◀▶.
- You can also set the position directly by touching  on the guideline of the recording screen.
- The guideline is not displayed during panorama picture recording.

[Center Marker]

A cross [+] is displayed to indicate the centre of the recording screen. This is useful for zooming while keeping the subject at the centre of the screen.

MENU →  **[Custom]** →  **[Monitor / Display]**

[Highlight]

You can set overexposed areas (areas that are too bright and where there are no shades of grey) to flash on the screen when the [Auto Review] function is activated or during playback.

- To reduce overexposed areas, record a picture by setting negative exposure compensation using the histogram display and so on as a reference.
- This feature is disabled during 4K photo playback, playback of pictures recorded in [Post Focus], Multi Playback, Calendar Playback, or Playback Zoom.
- This does not affect recorded pictures.



[Zebra Pattern]

You can check the area in a picture, which could result in overexposure, by displaying such an area using a zebra pattern.

[ZEBRA1]:





[ZEBRA2]:



Select [SET] to set the brightness to be displayed for each zebra pattern.

- The range of brightness you can select from is [50%] to [105%]. The [OFF] setting is available for [Zebra 2]. When [100%] or [105%] is selected, only the overexposed areas are displayed with the zebra pattern. When a smaller numeric value is set, the range of brightness to be displayed by each zebra pattern will increase.

- To reduce overexposed areas, record a picture by setting negative exposure compensation using the histogram display and so on as a reference.
- The displayed zebra pattern is not recorded.
- When [Zebra Pattern] is assigned to the function button using [Fn Button Set] (→60) in the [Custom] ([Operation]) menu, every time you press the assigned function button, the setting will switch in the following order: [Zebra 1] → [Zebra 2] → [Zebra OFF]. When [Zebra 2] is set to [OFF], you can switch the setting quickly in the following order: [Zebra 1] → [Zebra OFF].

MENU →  [Custom] →  [Monitor / Display]

[Expo.Meter]

Enabling/disabling the exposure meter display.

 Exposure meter

- When you set this function to [ON], an exposure meter is displayed during Programme Shift, aperture setting, and shutter speed setting.
- Proper exposure is not possible in the range indicated in red.
- If the exposure meter is not displayed, press the [DISP.] button to switch the display of the monitor.
- The exposure meter will turn off if no operation is performed for approximately 4 seconds.

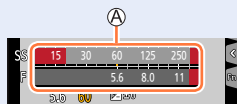

[MF Guide]

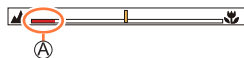

When you focus manually, the MF guide is displayed on the screen. You can check whether the point of focus is to the near side or the far side.

 Indicator for ∞ (infinity)



[Rec Area]

Switching the angle of view setting used for recording still pictures and motion pictures.

	Indicated as the angle of view when recording still pictures.
	Indicated as the angle of view when recording motion pictures.



- The recording area indicated is an approximation.
- [Rec Area] is fixed to  for 4K photo recording or recording in [Post Focus].

[Remaining Disp.]

Switching the display between the number of recordable pictures that you can take and the available recording time.

[Menu Guide]

Displaying/not displaying the selection screen when the mode dial is switched to [SCN]/.

MENU →  [Custom] →  [Lens / Others]

[Lens Position Resume]

Saves the focus position when you turn off the camera. When an interchangeable lens that is compatible with power zoom is in use, the zoom position is also saved.

[Lens Fn Button Setting]

Sets the function to be assigned to the focus button of an interchangeable lens.

- You can call up the assigned function by setting the focus selector switch of a compatible interchangeable lens to [Fn] and then pressing the focus button of the lens.

Settings: [Focus Stop] / [AF/AE LOCK] / [AF-ON] / [Stabilizer] / [Focus Area Set] / [AF Mode/MF] / [Preview] / [Off] / [Restore to Default]

- When [Focus Stop] is used, the focus is locked while the focus button is pressed and held.

[Self Timer Auto Off]

The self-timer is cancelled if the unit is turned off.

[Face Recog.]

The Face Recognition function recognises a face similar to a registered face and automatically adjusts focus and exposure for the face with higher priority. Even if a person you want to focus on is standing at the back or corner in a group photo, the camera will automatically recognise the person and record this person's face clearly.

Settings: [ON] / [OFF] / [MEMORY]

■ How the Face Recognition function works



During recording

- The camera recognises a registered face and adjusts focus and exposure.
- When registered faces that have set names are recognised, the names are displayed (max. 3 people).

During playback

- The name and age are displayed.



MENU →  [Custom] →  [Lens / Others]

■ Registering face pictures

Up to 6 people's face pictures can be registered along with such information as name and birthdate.

- ① Use ▼ to select [MEMORY] and press [MENU/SET]
- ② Use ▲▼◀▶ to select [New] and press [MENU/SET]

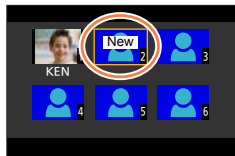

- ③ Align the face with the guide and record
 - Faces of subjects other than people (e.g. pets) cannot be registered.
 - When ► is pressed or [i] is touched, an explanation is displayed.



- ④ Use ▲▼ to select the item for editing and press [MENU/SET]



[Name]	Set the name. • For details on how to enter characters, refer to "Entering Text" (→63)
[Age]	Set the birthdate.
[Add Images]	Up to 3 face pictures of the person can be registered. ① Use ◀▶ to select [Add] and press [MENU/SET] • When a registered face picture is selected with cursor button, a screen to confirm deletion is displayed. Select [Yes] to delete the face picture. ② Record the picture (step ③)

■ Editing or deleting information about registered persons

- ① Use ▼ to select [MEMORY] and press [MENU/SET]
- ② Use ▲▼◀▶ to select the picture of the person to be edited or deleted and press [MENU/SET]
- ③ Use ▲▼ to select the item and press [MENU/SET]

[Info Edit]	Edit name or other registered information. (Step ④ of "Registering face pictures")
[Priority]	Set priority order for focus and exposure. ① Use ▲▼◀▶ to select the registration order and press [MENU/SET]
[Delete]	Delete information and face pictures of registered persons.



MENU →  **[Custom]** →  **[Lens / Others]**

Recording tips when registering face pictures

- Make sure the subject's eyes are open and mouth closed; have the subject face the camera directly, and make sure the outline of the face, the eyes and eyebrows are not hidden by hair.
- Make sure there are no heavy shadows on the face. (During registration, the flash is not used.)



Good example for registering a face



If the camera seems to have difficulty recognising faces when recording

- Register additional pictures of the same person's face, indoors and outdoors or with different expressions or angles.
- Register additional pictures at the place you are recording.
- If a registered person is no longer recognised, re-register that person.
- In some cases, the camera cannot recognise or incorrectly recognises even registered people depending on their expression or the environment.

- **[Face Recog.] functions only when Auto Focus mode is set to [AF].**
- Only the first picture of the burst recording will contain Face Recognition information.
- The name of the person recognised in the first picture is displayed in the case of group pictures.
- This function is not available in the following cases:
 - [Miniature Effect] (Creative Control Mode)
 - During motion picture recording
 - When recording 4K photos
 - When recording using [Post Focus]
 - When using [Time Lapse Shot]

MENU →  [Custom] →  [Lens / Others]

[Profile Setup]

You can set a name or birthday of a baby or pet before taking a picture to record the name or age in months/years in the picture.

Settings: [¹] ([Baby1]) / [²] ([Baby2]) / [] ([Pet]) / [OFF] / [SET]

■ Setting the name and age in months/years

- ① Use ▼ to select [SET] and press [MENU/SET]
- ② Use ▲▼ to select [Baby1], [Baby2] or [Pet] and press [MENU/SET]
- ③ Use ▲▼ to select [Age] or [Name] and press [MENU/SET]
- ④ Use ▼ to select [SET] and press [MENU/SET]
 - Enter the [Age].
 - Enter the [Name].
 - For details on how to enter characters, refer to “Entering Text” (→63)

■ Cancelling the display of the name and age in months/years

Set [Profile Setup] to [OFF].

- [Name] and [Age] print settings can be made on your computer using “PHOTOfunSTUDIO” software, which you download from a website. Text may also be stamped onto the still picture using the camera’s [Text Stamp].
- [Profile Setup] is not available for 4K photo recording or recording in [Post Focus].
- You cannot record the name or age in months/years in the following cases:
 - During motion picture recording
 - Still pictures that are taken while recording motion pictures



[Setup]

MENU →  [Setup]

- [Online Manual] (→223)
- [Cust.Set Mem.] (→93)
- [Clock Set] (→40)
- [World Time] (→223)
- [Travel Date] (→224)
- [Wi-Fi] (→224)
- [Bluetooth] (→225)
- [Wireless Connection Lamp] (→225)
- [Beep] (→225)
- [Economy] (→226)
- [Monitor Display Speed] (→227)
- [Monitor Display] / [Viewfinder] (→227)
- [Monitor Luminance] (→228)
- [Eye Sensor] (→228)
- [USB Mode] (→228)
- [TV Connection] (→229)
- [Language] (→230)
- [Version Disp.] (→230)
- [Folder / File Settings] (→230)
- [No.Reset] (→232)
- [Reset] (→232)
- [Reset Network Settings] (→232)
- [Pixel Refresh] (→233)
- [Sensor Cleaning] (→233)
- [Level Gauge Adjust.] (→233)
- [Demo Mode] (→233)
- [Format] (→34)

[Online Manual]

Settings: [URL display] / [QR Code display]

[World Time]

Sets the times for the region where you live and your travel destination.

- You can set [Destination] after setting [Home].

Settings: [Destination] / [Home]

1 Use ▲▼ to select [Destination] or [Home] and press [MENU/SET]

2 Use ◀▶ to select area and press [MENU/SET]



When [Destination] has been selected



When [Home] has been selected

- Ⓐ Current time at selected destination
- Ⓑ City/area name
- Ⓒ Difference with home time



■ To set daylight savings

Press ▲ in step 2. (Press again to release the setting)

- When daylight savings [☀️] is set, the current time is advanced by 1 hour. If the setting is cancelled, the time automatically returns to the current time.

■ When you come back from your travel destination

Select [Home] in step 1 and press [MENU/SET].

- If you cannot find your destination in the area displayed on the screen, set based on difference with home time.

[Travel Date]

■ [Travel Setup]

If you set your travel schedule and record pictures, the day of your trip on which the picture was taken will be recorded.

■ To record [Location]

Once the [Travel Setup] is set, you can set the location.

- For details on how to enter characters, refer to “Entering Text” (→63)
- To print [Location] or the number of days that have passed, either use [Text Stamp] (→246) or print using the “PHOTOfunSTUDIO” software.
- The travel date is calculated from the set departure date and the date set in the camera’s clock. When destination is set in [World Time], days elapsed are calculated based on local destination time.
- When [Travel Setup] is set to [OFF], the number of days elapsed is not recorded. It is not displayed even if [Travel Setup] is set to [SET] after recording.
- When the current date passes the return date, [Travel Setup] is automatically cancelled.
- [Travel Date] cannot be recorded for AVCHD motion pictures.
- [Location] cannot be recorded while recording motion pictures, recording 4K photos, or recording in [Post Focus].

[Wi-Fi]

■ [Wi-Fi Function] (→291)

■ [Wi-Fi Setup] (→297)





[Bluetooth]

- [Bluetooth] (→257)
- [Remote Wakeup] (→264)
- [Returning from Sleep Mode] (→268)
- [Auto Transfer] (→270)
- [Location Logging] (→272)
- [Auto Clock Set] (→273)
- [Wi-Fi network settings]

Registers a wireless access point. (→291)

- The wireless access point used for the Wi-Fi connection is automatically registered.
- Up to 17 wireless access points can be registered. If you try to register more than 17 access points, the oldest registered access points will be deleted.
- Performing [Reset Network Settings] will delete registered wireless access points.

[Wireless Connection Lamp]

The lamp lights while the wireless function is operating.

Settings: [ON] / [OFF]

[Beep]

Sets the beep sounds or shutter sounds.

- [Beep Volume]
- [Shutter Vol.]
- [Shutter Tone]

- When [Silent Mode] is set to [ON], [Beep] is not available.





[Economy]

■ [Sleep Mode]

The camera is automatically turned off if the camera has not been used for the time selected on the setting.

- When you want to use the camera again, either press the shutter button halfway or turn the camera back on.

■ [Sleep Mode(Wi-Fi)]

The camera is automatically turned off if the camera has not been used for approx. 15 minutes with no Wi-Fi connection.

- When you want to use the camera again, either press the shutter button halfway or turn the camera back on.

■ [Auto LVF/Monitor Off]

The monitor/viewfinder is automatically turned off if the camera has not been used for the time selected on the setting.

- To turn the monitor/viewfinder on again, press any button.

■ [Power Save LVF Shooting]

When monitor display is set by automatic switching between viewfinder and monitor, the camera automatically turns off if no operation is performed for some time.

- When you want to use the camera again, either press the shutter button halfway or turn the camera back on.

[Time]	Sets the amount of time before the camera turns off automatically. <ul style="list-style-type: none"> • When not using [Power Save LVF Shooting], select [OFF].
[Display]	Sets whether to turn off the camera automatically only while the [Monitor Info. Disp.] screen is displayed or while any screen is displayed. [Only Monitor Info.]: Sets the camera to turn off automatically only when [Monitor Info. Disp.] (→51) is displayed. [All Live View]: Sets the camera to turn off automatically when any screen is displayed.





- This function is not available in the following cases:
 - During motion picture recording/playback
 - When recording with ([4K Pre-Burst]) of the 4K Photo function
 - When recording in [Multi Exp.]
 - When connected to computer/printer
 - During Slide Shows
 - When using [Time Lapse Shot]
 - When [Auto Shooting] of [Stop Motion Animation] is set to [ON]
 - While the HDMI output is being used for recording.
- When using the AC adaptor (optional) and DC coupler (optional), [Sleep Mode], [Sleep Mode(Wi-Fi)] or [Power Save LVF Shooting] is disabled.

[Monitor Display Speed]

Sets the display speed of the monitor.

[30fps]	Minimises power consumption and the operating time is extended.
[60fps]	You can display a moving subject in fluid motion.

- The [Monitor Display Speed] setting does not affect the recorded picture.
- The viewfinder is fixed to [60fps].

[Monitor Display] / [Viewfinder]

Adjust brightness and colour of the monitor or viewfinder.

[Brightness]	Adjusts the brightness.
[Contrast]	Adjusts the contrast.
[Saturation]	Adjusts the vividness of colours.
[Red Tint]	Adjusts red hues.
[Blue Tint]	Adjusts blue hues.

- It will adjust the monitor when the monitor is in use, and the viewfinder when the viewfinder is in use.
- Some subjects may look different from their actual appearance, but the recorded picture will not be affected.





[Monitor Luminance]

Sets the monitor brightness according to the ambient light level.

(Auto)	The brightness is adjusted automatically depending on how bright it is around the camera.
(Mode 1)	The brightness is increased.
(Mode 2)	The brightness is standard.
(Mode 3)	The brightness is decreased.

- Some subjects may look different from their actual appearance, but the recorded picture will not be affected.
- [] returns to ordinary brightness if there is no operation for 30 seconds when recording. (Press any button or touch the screen to make the screen brighter again.)
- Setting [] or [] reduces the operating time.
- Cannot select [] during playback.
- When the AC adaptor (optional) and DC coupler (optional) are used, the initial setting is [].

[Eye Sensor]

[Sensitivity]	Use this setting to set the sensitivity of the eye sensor.
[LVF/Monitor Switch]	Use this setting to switch the display between the viewfinder and monitor. [LVF/MON AUTO] (Automatic switching between viewfinder and monitor) / [LVF] (Viewfinder display) / [MON] (Monitor display) • After the display is switched using the [LVF] button, the setting of [LVF/Monitor Switch] will also change.

[USB Mode]

Select communication method for when connecting camera to a computer or printer with USB connection cable (supplied).

[Select on connection]	Select communication method each time you connect to a computer or PictBridge-compatible printer.
[PC(Storage)]	Select when connecting to a computer.
[PictBridge(PTP)]	Select when connecting to a PictBridge-compatible printer.





[TV Connection]

■ [HDMI Mode (Play)]

Set the format for the output.

[AUTO]	Automatically sets the output resolution based on information from a connected TV.
[4K/25p]	Outputs pictures with a output resolution of 3840×2160 pixels using a progressive scan method for the number of effective scanning lines (2,160 lines). Even when [4K/25p] is set, MP4 motion pictures recorded with [4K/100M/30p] will be output at a resolution of "4K/30p".
[1080p]	Outputs pictures using a progressive scan method for the number of effective scanning lines (1,080 lines).
[1080i]	Outputs pictures using an interlace scan method for the number of effective scanning lines (1,080 lines).
[720p]	Outputs pictures using a progressive scan method for the number of effective scanning lines (720 lines).
[576p]	Outputs pictures using a progressive scan method for the number of effective scanning lines (576 lines). Depending on the connected TV, 480 available scan lines may be used for output.

- If no image appears on the TV with [AUTO], switch the setting to one other than [AUTO] to set a format supported by your TV. (Please read the operating instructions for the TV.)

■ [HDMI Info Display (Rec)]

Set whether to display recording information when you take pictures while you monitor them on a TV or other device by connecting the camera via HDMI micro cable. (→302)

■ [VIERA Link]

If you select [ON], operations of the camera and the VIERA Link compatible equipment connected to the camera with an HDMI micro cable are automatically linked, enabling you to control the camera with the remote control of the VIERA Link compatible equipment. (→303)





[Language]

Set the language displayed on the screen.

- If you set a different language by mistake, select [00] from the menu icons to set the desired language.

[Version Disp.]

Check the firmware version of the camera and lens.

- When you press [MENU/SET] while the version is displayed, software information for this unit, such as the licence, is displayed.

[Folder / File Settings]

Set the names of a folder and file for storing images.

Folder name	File name
<ul style="list-style-type: none"> ❶ Folder number (3-digits, 100–999) ❷ User-defined 5-digit number 	<ul style="list-style-type: none"> ❶ Colour space ([P]: sRGB, [_]: AdobeRGB) ❷ User-defined 3-digit number ❸ File number (4-digits, 0001–9999) ❹ File extension





[Select Folder]	Selects a folder for storing images. <ul style="list-style-type: none"> The number of files that can be stored is displayed for the folder name. 	
[Create a New Folder]	Creates a new folder by advancing the folder number. <ul style="list-style-type: none"> When no folder for storing images is available on a card, the folder number reset screen is displayed. 	
	[OK]	Creates a new folder using the same user-defined 5-digit number comprising a folder name as the current setting.
	[Change]	Creates a new folder by entering a new user-defined 5-digit number comprising a folder name to change the current folder name. <ul style="list-style-type: none"> Characters that can be set: uppercase alphanumeric characters, numbers, and [_] For details on how to enter characters, refer to “Entering Text” (→63)
[File Name Setting]	[Folder Number Link]	Sets the same number in the folder name to a user-defined 3-digit number in a file name.
	[User Setting]	Sets a file name by entering a new user-defined 3-digit number. <ul style="list-style-type: none"> Characters that can be set: uppercase alphanumeric characters, numbers, and [_] For details on how to enter characters, refer to “Entering Text” (→63)

- Up to 1,000 files can be stored in a single folder.
- The serial numbers from 0001 to 9999 are assigned to the files stored in the order in which pictures are taken. When a folder destination is changed, the file is stored with the file number following the preceding file number.
- In the following cases, a new folder is automatically created by advancing the folder number when the next file is saved.
 - When 1,000 files are stored in a folder
 - When a file consisting of the file number of “9999” is stored in a folder
- When folders with numbers from 100 to 999 already all exist, you cannot create a new folder. We recommend saving all necessary pictures to your computer or other devices and formatting the card.





[No.Reset]

Reset picture file numbers. (The folder number is updated and the file number starts from 0001.)

- To reset folder number to 100:

First, format the card, and reset the file numbers using [No.Reset]. Then, select [Yes] on the folder number reset screen.

- A folder number between 100 and 999 can be assigned. Numbers cannot be reset once folder number reaches 999. In this case, save all necessary pictures to your computer, and format the card ([→34](#)).

[Reset]

The following settings are reset to the default:

- Recording settings and drive mode
- Setup settings ([Wi-Fi Setup] and [Bluetooth] settings)
- Custom settings ([Face Recog.] and [Profile Setup] settings)
- Setup/custom settings
(except for [Wi-Fi Setup], [Bluetooth], [Face Recog.] and [Profile Setup] settings)

- When the setup/custom settings are reset, the following settings are also reset:
 - The [World Time] setting
 - The [Travel Date] setting (Departure date, Return date, [Location])
 - The settings of [Rotate Disp.], [Picture Sort] and [Delete Confirmation] in the [Playback] menu
- Folder numbers and clock settings will not be reset.

[Reset Network Settings]

Network settings are reset to the default, such as equipment information you have registered using [Wi-Fi Setup] or [Bluetooth].
(Excluding [LUMIX CLUB])





[Pixel Refresh]

It will perform optimisation of imaging device and image processing.

- Imaging device and image processing is optimised when the camera is purchased. Use this function when bright spots that do not exist in the subject get recorded.
- Turn the camera off and on after the pixels are corrected.

[Sensor Cleaning]

Dust reduction to blow off the debris and dust that have affixed to the front of the imaging device is performed.

- Dust Reduction Function will operate automatically when the camera is turned on, but you can use this function when you see dust.

[Level Gauge Adjust.]

■ [Adjust.]

Hold the camera in a horizontal position, and press [MENU/SET]. The level gauge will be adjusted.

■ [Level Gauge Value Reset]

Restores the default level gauge setting.

[Demo Mode]

You can try focusing, peaking, etc. in [Post Focus], with the image picture.



[My Menu]

You can register frequently used menus and display them on [My Menu]. Up to 23 menus can be registered.

MENU →  **[My Menu]** → **[My Menu Setting]**

[Add]	Select and register a menu to be displayed on [My Menu].
[Sorting]	Change the order of the menus to be displayed on [My Menu]. Select the menu whose order you want to change and set the new location.
[Delete]	Delete a registered menu from the [My Menu] display. [Delete Item]: Select and delete a menu from the displayed menus. [Delete All]: Delete all displayed menus.
[Display from My Menu]	Set a screen to be displayed when the menu screen is displayed. [ON]: Displays [My Menu] [OFF]: Displays the menu used the previous time

[Playback]

- [Slide Show] (→236)
- [Playback Mode] (→237)
- [Protect] (→238)
- [Rating] (→238)
- [Title Edit] (→239)
- [Face Rec Edit] (→239)
- [RAW Processing] (→240)
- [4K PHOTO Bulk Saving] (→242)
- [Light Composition] (→243)
- [Sequence Composition] (→244)
- [Clear Retouch] (→245)
- [Text Stamp] (→246)
- [Resize] (→247)
- [Cropping] (→248)
- [Rotate] (→248)
- [Video Divide] (→249)
- [Time Lapse Video] (→249)
- [Stop Motion Video] (→250)
- [Rotate Disp.] (→250)
- [Picture Sort] (→250)
- [Delete Confirmation] (→251)

● It may not be possible to set or edit pictures taken with other cameras.

■ How to select an image(s) after selecting [Single] or [Multi]

When [Single] and [Multi] are not available, select a picture in the same way as when [Single] is selected.

[Single]

- ① Use ◀▶ to select a still picture and press [MENU/SET]
 - If [Set/Cancel] is displayed at the right bottom of the screen, the setting is cancelled when [MENU/SET] is pressed again.



[Multi]

When a screen similar to the one on the right is displayed:

- ① Use ▲▼◀▶ to select a still picture and press [MENU/SET] (repeat)
 - To cancel → Press [MENU/SET] again.
- ② Press [DISP.] button to execute

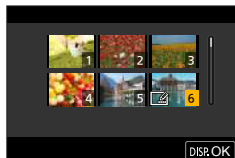

When a screen similar to the one on the right is displayed:

- ① Use ▲▼◀▶ to select a still picture and press [MENU/SET] (repeat)
 - To cancel → Press [MENU/SET] again.

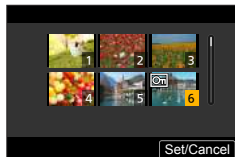

[Slide Show]









Automatically plays back recorded pictures, one after another. You can organise slide shows composed of only still pictures or only motion pictures. Recommended when viewing on TV screen.

MENU →  **[Playback]** → **[Slide Show]**

1 Use ▲ ▼ to select the item and press [MENU/SET]

- If you select [Picture Only], 4K burst files and pictures recorded using [Post Focus] will also be played back.
- Only an in-focus representative image will be played back from pictures recorded using [Post Focus].

2 Use ▲ to select [Start] and press [MENU/SET]**■ Operations during Slide Show**

Operation	Touch operation	Description
▲		Play / Pause
◀		Previous
▶		Next
▼		Stop
		Volume up
		Volume down

■ To change settings

Select [Effect] or [Setup] and press [MENU/SET].

[Effect]		This allows you to select the screen effects when switching from one picture to the next.
[Setup]	[Duration]	[Duration] can be set only when [Effect] is set to [OFF].
	[Repeat]	[ON] / [OFF]
	[Sound]	[AUTO]: With still pictures, music will play back, and with motion pictures, audio will play back. [Music]: Music effect will play back. [Audio]: Audio is played back from motion pictures. [OFF]: Music and audio will not play back.

- During slide shows of 4K burst files, pictures recorded in [Post Focus], or group pictures, effects will stay turned off even if [Effect] is set.
- When you play back the following pictures in a slide show, the [Duration] setting is disabled.
 - Motion pictures
 - 4K burst files
 - Pictures recorded using [Post Focus]
 - Panorama pictures
 - Group pictures

[Playback Mode]

Selects the type of the pictures and play back. ([Normal Play], [Picture Only], [Video Only])

MENU →  **[Playback]** → **[Playback Mode]**

1 Use ▲ ▼ to select the item and press [MENU/SET]

- If you select [Picture Only], 4K burst files and pictures recorded using [Post Focus] will also be played back.



[Protect]

Set protection to disable picture deletion. Prevents deletion of important pictures.

MENU →  **[Playback]** → **[Protect]**

1 Select picture (→235)**■ To clear all**

Select **[Protect]** → **[Cancel]** → **[Yes]**, and then press **[MENU/SET]**



When you set the write-protect switch on the card to the "LOCK" position, the picture is not erased.

- The picture is erased when formatting, even if it is protected.
- May not be effective when using other devices.

[Rating]

You can label the pictures in five levels (ratings). When you have performed **[Rating]**, the following operations will be available.

- Deletes all pictures except the labelled pictures.
- You can check the rating level of the pictures by displaying the details of the file on Windows 8, Windows 8.1, and Windows 10 (only JPEG pictures).

MENU →  **[Playback]** → **[Rating]**

1 Select picture (→235)**2 Use ◀▶ to set the Rating levels (1 to 5) and press [MENU/SET]**

(Repeat steps **1** and **2** to perform the setting with **[Multi.]**)

■ To clear all

Select **[Rating]** → **[Cancel]** → **[Yes]**, and then press **[MENU/SET]**

- When you have performed **[Rating]** for group pictures, the setting applies to all pictures in the group, and the number rating set is shown on the rating settings icon of the first picture. If the total number of pictures is 1,000 or higher, [999+] is displayed.
- Only when **[Playback Mode]** is set to **[Normal Play]**, you can select **[Cancel]**.
- You can set only Rating **[5]** for AVCHD motion pictures.



[Title Edit]

You can enter characters (titles etc.) on a recorded picture. After text has been registered, it can be stamped in prints using [Text Stamp] (→246).

MENU →  **[Playback]** → **[Title Edit]**

1 Select a still picture (→235)

-  is displayed for pictures with texts already stamped.

2 Enter characters

- For details on how to enter characters, refer to “Entering Text” (→63)
- To delete texts, delete all the characters in the character input screen.

- You can print out texts using the “PHOTOfunSTUDIO” software.
- You can set up to 100 pictures at one time with [Multi].
- This function is not available in the following cases:
 - Motion pictures
 - 4K burst files
 - Pictures recorded using [Post Focus]
 - Still pictures recorded with the [Quality] setting [RAW:⚙️], [RAW:⚙️] or [RAW]

[Face Rec Edit]

Edit or delete the recognition information for pictures with incorrect information.

MENU →  **[Playback]** → **[Face Rec Edit]** → **[REPLACE]** or **[DELETE]**

1 Use ◀▶ to select picture and press [MENU/SET]**2 Use ◀▶ to select a person and press [MENU/SET]**

- If [DELETE], go to step 4.

3 Use ▲▼◀▶ to select the person to replace for another and press [MENU/SET]**4 Use ◀ to select [Yes] and press [MENU/SET]**

- When Face Recognition information is deleted, it cannot be restored.
- Edit the Face Recognition information in group units for a picture group. (You cannot edit the information for each picture in a group.)
- You can edit only the first picture in a group.



[RAW Processing]

You can use the camera to develop still pictures that were recorded in RAW format. The created still pictures are saved in JPEG format.

[MENU] →  **[Playback]** → **[RAW Processing]**

1 Press **◀▶** to select RAW file and press **[MENU/SET]**

2 Press **▲▼** to select the item and then press **[MENU/SET]** to set

- The following items can be set. The settings used during recording are applied at the time of setting.

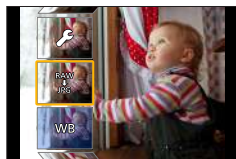

[White Balance]	You can select White Balance to make adjustments. When you select an item with  , you can develop the pictures using the same settings that were applied for recording.
[Brightness correction]	You can correct brightness in the range from -2 EV to +2 EV.
[Photo Style]	You can select the [Photo Style] effects.
[i.Dynamic]	You can select the [i.Dynamic] settings.
[Contrast]	You can adjust the contrast.
[Highlight]	You can adjust the brightness of a highlighted area.
[Shadow]	You can adjust the brightness of a shadowed area.
[Saturation] / [Color Tone]	You can adjust the saturation. (You can adjust the colouring when [Monochrome], [L.Monochrome] or [L.Monochrome D] is selected for [Photo Style].)
[Filter Effect]	You can select a Filter effect. (Only when [Monochrome], [L.Monochrome] or [L.Monochrome D] is selected for [Photo Style].)
[Grain Effect]	You can set the graininess. (Only when [Monochrome], [L.Monochrome] or [L.Monochrome D] is selected for [Photo Style].)
[Noise Reduction]	You can set noise reduction.
[i.Resolution]	You can select the [i.Resolution] settings.
[Sharpness]	You can adjust the impression of resolution.
[More Settings]	Use ▲▼ to select items and press [MENU/SET] to perform the following operations. [Reinstate Adjustments]: You can restore the settings to the ones used during recording. [Color Space]: You can select [Color Space] from either [sRGB] or [AdobeRGB]. [Picture Size]: You can select the picture size ([L], [M], or [S]) of a JPEG file when saving pictures.

3 Press [MENU/SET] to finalise the setting

- The screen in step 2 reappears. To set another item, repeat steps 2 to 3.

4 Press ▲ ▼ to select [Begin Processing] and press [MENU/SET]

■ Setting each item

When you select an item, the setting screen appears.

Operation	Touch operation	Description
	Drag	Used to make adjustments
▲	[WB K Set]	Used to display the colour temperature setting screen (Only when [White Balance] is set to [K])
▼	[Adjust.]	Used to display the White Balance fine adjustment screen (Only when [White Balance] is set)
[DISP.]	[DISP.]	Used to display the comparison screen
[MENU/SET]	[Set]	Used to finalise an adjustment you just made and to return to the item selection screen



- If you have selected [Noise Reduction], [i.Resolution], or [Sharpness], the comparison screen is not displayed.
- You can also zoom in by quickly touching the display twice. (If the display was enlarged, it returns to the same magnification ratio.)

The following operating methods are available to make adjustments on the comparison screen.

Ⓐ Current setting

Operation	Touch operation	Description
	Drag	Used to make adjustments
[DISP.]	[DISP.]	Used to return to the setting screen
[MENU/SET]	[Set]	Used to finalise an adjustment you just made and to return to the item selection screen

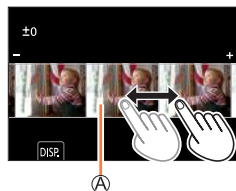

- If you touch the picture at the centre, it will be enlarged. If you touch [↔], the picture will be reduced to the original size.

- The result of a RAW file developed by this camera and a RAW file developed by the software “SILKYPIX Developer Studio” will not be exactly the same.
- A RAW picture recorded on this camera is always saved with the aspect ratio set to [4:3] (5184×3888), but if you perform [RAW Processing] from the [Playback] menu, the picture will be processed with the aspect ratio at the time of recording and the angle of view set by [Ex. Tele Conv.] ([Rec]).
- Zoomed-in images recorded with [Ex. Tele Conv.] ([Rec]) cannot be processed if you select a [Picture Size] setting larger than their size at the time of recording.
- The [White Balance] setting of still pictures recorded using [Multi Exp.] is fixed to the setting used during recording.
- Edit group pictures one by one. The edited pictures will be newly saved separately from the original group pictures.
- When an HDMI micro cable is connected, [RAW Processing] is disabled.
- You can perform RAW processing on pictures recorded using this unit only.

[4K PHOTO Bulk Saving]

You can bulk save 5 seconds' worth of 4K recording from a 4K burst file.

MENU →  **[Playback]** → **[4K PHOTO Bulk Saving]**

1 Use ◀▶ to select the 4K burst files and press [MENU/SET]

- If the burst time is 5 seconds or less, all the frames can be saved as a picture.

2 Select the first frame to be bulk saved as a picture (→125, 126)

- The picture will be saved in JPEG format as a single burst picture group.



[Light Composition]

Select multiple frames from 4K burst files that you wish to combine. Parts of the image that are brighter than the preceding frame will be superimposed on the preceding frame to combine the frames into one picture.



MENU → [Playback] → [Light Composition]

1 Use ◀▶ to select the 4K burst files and press [MENU/SET]

2 Choose the combining method and press [MENU/SET]

■ [Composite Merging]: Selecting frames to combine

① Drag the slide bar or use ▲▼◀▶ to select the frames to combine

② Press [MENU/SET]

- The selected frames are remembered, and the display goes to the preview screen.
- Use ▲▼ to select items and press [MENU/SET] to perform the following operations.
 - [Next]: Lets you select more frames for combining.
 - [Reselect]: Discards the frame selected immediately before and lets you select a different image.



③ Repeat steps ① - ② to select more frames to combine (up to 40 frames)

④ Press ▼ to select [Save], and then press [MENU/SET]

■ [Range Merging]: Selecting a range to combine

① Select the frame of the first picture and then press [MENU/SET]

- The selection method is the same as in step ① of [Composite Merging] setting.

② Select the frame of the last picture and then press [MENU/SET]

3 Select [Yes] at the confirmation screen and press [MENU/SET]

- Pictures are saved in JPEG format. Recording information (Exif information) of the first frame such as shutter speed, aperture, and ISO sensitivity are also registered.

[Sequence Composition]

Select multiple frames from a 4K burst file to create a sequence composition of a moving subject into one picture.



MENU → **[Playback]** → **[Sequence Composition]**

1 Use to select the 4K burst files and press **[MENU/SET]**

2 Select frames to combine

Select the frames so that the moving subject will not overlap on the preceding or subsequent frames. (The sequence composition may not be created properly if the subject overlaps.)

① Drag the slide bar or use to select the frames to combine

② Press **[MENU/SET]**

- The selected frames are remembered, and the display goes to the preview screen.
- Use to select items and press **[MENU/SET]** to perform the following operations.
 - **[Next]**: Lets you select more frames for combining.
 - **[Reselect]**: Discards the frame selected immediately before and lets you select a different image.



③ Repeat steps ① - ② to select more frames to combine (from 3 to 40 frames)

④ Press to select **[Save]**, and then press **[MENU/SET]**

3 Select **[Yes]** at the confirmation screen and press **[MENU/SET]**

- Pictures are saved in JPEG format. Recording information (Exif information) of the first frame such as shutter speed, aperture, and ISO sensitivity are also registered.



Tips for [Sequence Composition]

We recommend using a tripod to take pictures for [Sequence Composition].

[Clear Retouch]

You can erase unnecessary parts recorded on the pictures taken.

- The erasure operation can only be performed by touching. [Clear Retouch] automatically enables the touch operation.



MENU → [Play] → **[Playback]** → **[Clear Retouch]**

1 Use ◀▶ to select a still picture and press [MENU/SET]**2 Drag your finger over the part you want to erase**

- The parts to be erased are coloured.
- Touching [Undo] will return the coloured part back to its previous state.

**Erasing details (enlarging the display)****① Touch [SCALING]**

- On the touch screen, pinch out your two fingers to zoom in, and pinch in your two fingers to zoom out.
- Dragging the screen allows you to move the enlarged part.

② Touch [REMOVE]

- This will bring you back to the operation of dragging your finger over the part you want to erase. The part you want to erase can be dragged even while the picture is enlarged.

**3 Touch [Set]****4 Touch [Save] or press [MENU/SET]**

- Pictures may appear unnatural because the background of deleted parts is artificially created.
- Edit group pictures one by one. The edited pictures will be newly saved separately from the original group pictures.
- Not available when the viewfinder is in use.
- When an HDMI micro cable is connected, [Clear Retouch] is disabled.
- This function is not available in the following cases:
 - Panorama pictures
 - Motion pictures
 - 4K burst files
 - Pictures recorded using [Post Focus]
 - Still pictures recorded with the [Quality] setting [RAW]

[Text Stamp]



You can stamp the recording date and time, names, travel destination, travel dates, etc. on the recorded still pictures.

MENU →  **[Playback]** → **[Text Stamp]**

1 Select a still picture (→235)

-  appears on screen if the picture is stamped with text.

2 Use ▼ to select [Set] and press [MENU/SET]

[Shooting Date]	[W/O TIME]: Stamp recording date [WITH TIME]: Stamp recording date and time
[Name]	 : Stamp name registered in Face Recognition  : Stamp name registered in [Profile Setup]
[Location]	Stamp location registered in [Setup] menu's [Travel Date]
[Travel Date]	Stamp number of days that have elapsed since the travel date set in [Setup] menu's [Travel Date]
[Title]	Stamp text registered in [Title Edit]

3 Press [Q.MENU/↵] button**4 Use ▲ to select [OK] and press [MENU/SET]**

- **Do not request date printing in store or make date printing on printer for still pictures with date stamps. (Date printing may be overlapped.)**
- You can set up to 100 pictures at one time with [Multi].
- The picture quality may be coarser.
- If you stamp text on the pictures in a group, the edited pictures will be newly saved separately from the original group pictures.
- This function is not available in the following cases:
 - Motion pictures
 - 4K burst files
 - Pictures recorded using [Post Focus]
 - Still pictures recorded with the [Quality] setting [RAW]
 - Panorama pictures
 - Still pictures that other texts had already been stamped
 - Still pictures taken without setting clock



[Resize]

Picture size can be reduced to facilitate e-mail attachment and use in web pages, etc.

MENU →  **[Playback]** → **[Resize]**

1 Select a still picture and size**[Single]**

- ① Use ◀▶ to select a still picture and press [MENU/SET]
- ② Use ▲▼ to select size and press [MENU/SET]

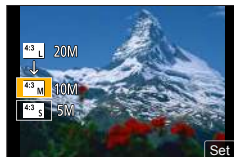
**[Multi] (up to 100 pictures)**

- ① Use ▲▼ to select size and press [MENU/SET]
- ② Use ▲▼◀▶ to select a still picture and press [MENU/SET] (repeat)
 - To cancel → Press [MENU/SET] again.
- ③ Press [DISP.] button to execute

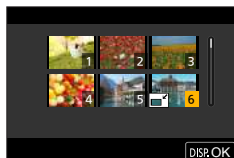

- Picture quality is reduced after resizing.
- This function is not available in the following cases:
 - Motion pictures
 - 4K burst files
 - Pictures recorded using [Post Focus]
 - Still pictures recorded with the [Quality] setting [RAW]
 - Panorama pictures
 - Group pictures
 - Still pictures that other texts had already been stamped







[Cropping]

Enlarge your still pictures and crop unwanted areas.

MENU →  **[Playback]** → **[Cropping]**

1 Use  to select a still picture and press **[MENU/SET]**

2 Select area to crop and press **[MENU/SET]**

Operation	Touch operation	Description
		Enlarges the picture
		Reduces the picture
	Drag	Moves the enlarged area

- Edit group pictures one by one. The edited pictures will be newly saved separately from the original group pictures.
- Original Face Recognition information will not be copied when still pictures are cropped.
- Picture quality is reduced after cropping.
- This function is not available in the following cases:
 - Motion pictures
 - 4K burst files
 - Pictures recorded using [Post Focus]
 - Still pictures recorded with the [Quality] setting [RAW]
 - Panorama pictures
 - Still pictures that other texts had already been stamped

[Rotate]

You can manually rotate the picture in 90-degree units.

- You cannot select [Rotate] when [Rotate Disp.] is set to [OFF].

MENU →  **[Playback]** → **[Rotate]**

1 Use  to select picture and press **[MENU/SET]**

2 Use  to select the rotation direction and press **[MENU/SET]**

: Rotate a picture 90 degrees clockwise.

: Rotate a picture 90 degrees counterclockwise.

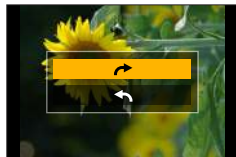



[Video Divide]

A single motion picture can be split into 2 parts. This is convenient when you want to keep just the necessary scenes, or if you wish to delete unnecessary scenes to increase free space on your card, such as when travelling.

MENU →  **[Playback]** → **[Video Divide]**

1 Use   to select a motion picture to split and press **[MENU/SET]**

2 Press  at where you want to split a motion picture to pause it

- If you press   while paused, you can make finer adjustments to the splitting positions in a motion picture.

3 Press 

- **The original motion picture that was split does not remain.**
(There will only be the 2 motion pictures that were created after the split.)



- During dividing, do not turn off the camera or remove the card or battery. If you do so, the motion picture may be deleted.
- Motion pictures cannot be divided at a location close to the start or end of the motion picture.
- This function is not available in the following case:
 - Motion pictures with a short recording time

[Time Lapse Video]

You can create a motion picture from the pictures in a group that was recorded using [Time Lapse Shot].

MENU →  **[Playback]** → **[Time Lapse Video]**

1 Use   to select the [Time Lapse Shot] picture group and press **[MENU/SET]**

2 Create a motion picture after selecting a production method

- For details, refer to step **5** and the subsequent steps (→146).



[Stop Motion Video]

You can create a motion picture from the pictures in a group that was recorded using [Stop Motion Animation].

MENU →  **[Playback]** → **[Stop Motion Video]**

- 1 Use ◀▶ to select a stop motion animation group and press **[MENU/SET]**
- 2 Create a motion picture after selecting a production method
 - For details, refer to step 8 and the subsequent steps (→149).

[Rotate Disp.]

This mode allows you to display pictures vertically if they were recorded holding the camera vertically.

MENU →  **[Playback]** → **[Rotate Disp.]** → **[ON]**

- When you play back pictures on a PC, they cannot be displayed in the rotated direction unless the OS or software is compatible with Exif. Exif is a file format for still pictures which allows recording information, etc. to be added. It was established by "JEITA (Japan Electronics and Information Technology Industries Association)".

[Picture Sort]

You can set the display sequence used for playing back pictures on this unit.

MENU →  **[Playback]** → **[Picture Sort]**

[FILE NAME]	Displays pictures in the folder name or file name sequence. This display format allows you to find the storage location of a picture on a card more easily.
[DATE/TIME]	Displays pictures according to the date and time that the pictures were taken in chronological order. When the pictures are taken using several cameras and stored on the same card, this display format allows you to find a specific picture more easily.

- Pictures may not be displayed according to the [DATE/TIME] sequence immediately after a card is inserted into this unit. In that case, wait a while, and the pictures will be displayed in the [DATE/TIME] sequence.

[Delete Confirmation]

This sets which option, [Yes] or [No], will be highlighted first when the confirmation screen for deleting a picture is displayed.

It is set to ["No" first] at the time of purchase.

MENU →  **[Playback]** → **[Delete Confirmation]**

["Yes" first]	[Yes] is highlighted first, so deletion can be done quickly.
["No" first]	[No] is highlighted first. Accidental deletion of pictures is avoided.

What you can do with the Wi-Fi®/Bluetooth® function

Operating the camera by connecting it to a smartphone

- Operating the shutter button of the camera using a smartphone (remote recording) (→265)
- Playing back or saving images stored on the camera, or uploading them on social media sites (→269)
- Combining motion pictures recorded with Snap Movie according to your preference on a smartphone (→273)

Expanding the scope of applications by connecting the camera to a smartphone compatible with Bluetooth Low Energy

- Pairing (connection setup) (→257)
- Turning on/off the camera using a smartphone (→264)
- [B] (Bulb) recording (→267)
- Transferring recorded images to a smartphone automatically (→270)
- Writing location information of a smartphone on a recorded image (→272)
- Synchronising the camera's clock with a smartphone (→273)

Displaying still pictures on a TV (→275)

Wireless printing (→280)

Sending pictures to AV device (→281)

Sending pictures to a PC (→282)

Using WEB services (→284)

- This manual uses the term “smartphone” for both smartphones and tablets unless it is necessary to distinguish between them.



Wi-Fi/Bluetooth Function

■ Before Use

- Complete the date and time settings in advance. (→40)
- To use the Wi-Fi function on this unit, a wireless access point or a destination device equipped with the wireless LAN function is required.

■ Lighting of the WIRELESS connection lamp (Blue)

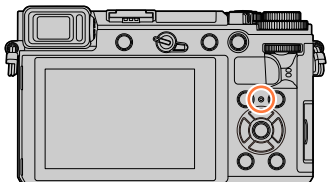

Lit: When the Wi-Fi/Bluetooth function is ON or connected

Blinking: When sending picture data

- In [Wireless Connection Lamp] in the [Setup] menu, you can set the lamp so that it will not light/flash. (→225)

■ [Wi-Fi] button

In this Operating Instructions, a function button to which [Wi-Fi] is assigned is referred to as the [Wi-Fi] button. (At the time of purchase, [Wi-Fi] is assigned to [Fn4] button in recording mode.)

- The [Wi-Fi] button can be set separately for recording and playback (→60).

To start up the Wi-Fi function (When in recording mode):

① Touch [Fn]



② Touch [Fn4]



■ Operations that can be performed by pressing the [Wi-Fi] button

If you press the [Wi-Fi] button when you do not have a Wi-Fi connection, the camera enters a standby mode in which it can connect directly to the smartphone. (→260)

- If you press the [DISP.] button at that time, you can select a destination from the history of previous connections and quickly connect. (→295)

When the camera is connected to Wi-Fi, you can press [Wi-Fi] button and perform the following operations.

[Terminate the Connection]	Terminates the Wi-Fi connection.
[Change the Destination]	Terminates the Wi-Fi connection, and allows you to select a different Wi-Fi connection.
[Change Settings for Sending Images]	For details (→278).
[Register the Current Destination to Favorite]	Registering the current connection destination or the connection method, you can easily connect with the same connection method next time.
[Network Address]	For details (→297).

- Depending on the Wi-Fi function being used or the connection destination, you may not be able to perform some of these operations.

■ Describing method

When selecting “[Select a destination from History]”, etc. is described in a step, perform any of the following operations.

With cursor button operations

Use cursor button to select [Select a destination from History] and press [MENU/SET].

With touch screen operations

Touch [Select a destination from History].

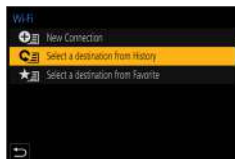

- **Do not remove the memory card or battery or move to an area without any reception while sending images.**
- The camera cannot be used to connect to a public wireless LAN connection.
- We recommend that you use a fully charged battery when you send pictures.
- When sending images on a mobile network, high packet communication fees may be incurred depending on the details of your contract.
- Pictures may not be completely sent depending on radio wave conditions. If the connection is terminated while sending pictures, pictures with missing sections may be sent.



Connecting the camera to a smartphone

You can remotely operate the camera using a smartphone.

The "Panasonic Image App" (hereafter "Image App") must be installed on your smartphone.

Installing the smartphone/tablet app "Panasonic Image App"

Supported OS	Android™: Android 4.2 or later (Android 5.0 or higher is required to use the Bluetooth function) iOS: iOS 9.0 or later (The Bluetooth function cannot be used with the iPad 2)
Installation procedure	<ol style="list-style-type: none"> ① Connect your device to a network ② (Android) Select "Google Play™ Store" (iOS) Select "App Store" ③ Enter "Panasonic Image App" or "LUMIX" into the search box ④ Select "Panasonic Image App" and install it 

- Use the latest version.
- Supported OS versions as of February 2018. Supported OS versions may be changed without prior notice.
- The service may not be able to be used properly depending on the type of smartphone being used.

For the latest information on the "Image App", refer to the support site below.

<http://panasonic.jp/support/global/cs/dsc/> (This site is available in English only.)

- When downloading the app on a mobile phone network, high packet communication fees may be incurred depending on the details of your contract.
- For details about the operating procedure, etc., refer to [Help] in the "Image App" menu.
- When you operate the "Image App" on the smartphone that is connected to the camera via Wi-Fi, [Help] in the "Image App" may not be displayed depending on the smartphone. In this case, after terminating the connection to the camera, reconnect the smartphone to a mobile phone network or to a Wi-Fi router, and then display [Help] in the "Image App".
- Some of the screens and information provided in this document may be different depending on the supported operating system and "Image App" version.



Connecting the camera to a smartphone

Connecting the camera to a smartphone compatible with Bluetooth Low Energy

You can connect the camera to a smartphone via a Bluetooth connection.

Supported smartphones

Android: Android 5.0 or higher equipped with Bluetooth 4.0 or higher
(excluding those that do not support Bluetooth low energy)
iOS: iOS 9.0 or higher (excluding the iPad 2)

■ First-time connection

You need to set up pairing (connection) for the first time only. When pairing is set up, a Wi-Fi connection is made automatically.

(On the camera)

MENU →  **[Setup]** → **[Bluetooth]** → **[Bluetooth]**
→ **[SET]** → **[Pairing]**

- The camera enters pairing standby mode and displays its device name.

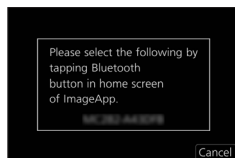

(On your smartphone)

- ① Start "Image App"
 - If a message is displayed indicating that the smartphone is searching for cameras, close the message.
- ② Select [Bluetooth]
- ③ Turn on the Bluetooth
- ④ Select the device name displayed on the camera's screen from the [Camera enable to be registered] list
 - Bluetooth connection between the camera and the smartphone will be made.
(For Android devices) A Wi-Fi connection will be made by selecting [Connection].

If you are using an Android device, follow the steps up to here to complete the setup. Proceed to the steps below only if you are using an iOS device (iPhone/iPod touch/iPad).

- If [Wi-Fi Password] (→297) is set to [OFF] on the camera, select [Wi-Fi Setup]. (At the time of purchase, [Wi-Fi Password] is set to [OFF])
- If [Wi-Fi Password] is set to [ON] on the camera, you need to install the profile.
 - ① Install the profile
 - If the smartphone is locked with a passcode, enter the passcode to unlock the smartphone.
 - ② Exit the browser

Connecting the camera to a smartphone

- ⑤ Turn on the Wi-Fi function in the setting menu
- ⑥ On the Wi-Fi setting screen, select the SSID displayed on the camera (The device name selected in step ④)
 - If the SSID is not displayed, it may be displayed after the Wi-Fi function is turned off and on.
 - When you need to change the connected device, follow the on-screen message to change the setting.
- ⑦ Start "Image App"
 - The paired smartphone will be registered as a paired device after connected via Wi-Fi.

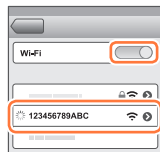

■ Connecting to the paired smartphone (connecting for the second and subsequent times)

(On the camera)

- ① Enable the Bluetooth function

MENU → [Setup] → [Bluetooth] → [Bluetooth] → [ON]

(On your smartphone)

- ② Start "Image App"
 - If a message is displayed indicating that the smartphone is searching for cameras, close the message.
 - ③ Select [Bluetooth]
 - ④ Turn on the Bluetooth
 - ⑤ Select the device name displayed on the camera's screen from the [Camera registered] list
- Even if you set up pairing with more than one smartphone, you can only connect to one smartphone at a time.

■ Terminating the Bluetooth connection

MENU → [Setup] → [Bluetooth] → [Bluetooth] → [OFF]

- The connection will be terminated and the camera's Bluetooth function will be deactivated.
- Even if you terminate the connection, the pairing information for it will not be deleted.

Connecting the camera to a smartphone

■ Deleting the pairing information**(On the camera)**

① Set the menu

MENU →  **[Setup]** → **[Bluetooth]** → **[Bluetooth]** → **[SET]** → **[Delete]**

② Select the smartphone you want to delete

(On your smartphone)

Select the camera (device name) for which to delete the pairing information from the [Camera registered] list, and delete the registration.

- [🔒] is displayed on the recording screen when a Bluetooth device is connected. If the Bluetooth function is enabled, but the smartphone is not connected, the displayed [🔒] is semi-transparent.
- When it takes time to set up pairing between a smartphone and a camera, delete the pairing information of both devices and register them again. This may enable the devices to be recognised properly.
- Up to 16 smartphones can be registered. If you try to register more than 16 devices, the smartphone with the oldest registration history will be replaced.
- Performing [Reset Network Settings] will delete registered device information.



Connecting the camera to a smartphone

Connecting the camera to a smartphone that does not support Bluetooth Low Energy

Connect to a smartphone via Wi-Fi.

- You can also connect via Wi-Fi to a smartphone that supports Bluetooth low energy by following the same steps.

Connecting without using the password

You can easily establish a Wi-Fi connection on this unit without entering a password on your smartphone.

(On the camera)

MENU →  **[Setup]** → **[Wi-Fi]** → **[Wi-Fi Function]** → **[New Connection]**
→ **[Remote Shooting & View]**

Ⓐ SSID

- The information required for directly connecting your smartphone to this unit (SSID) is displayed.
- You can also display the information by pressing [Wi-Fi] button on the camera.



(On your smartphone)

- Turn on the Wi-Fi function in the setting menu
- Select the SSID displayed on the screen of the camera
- Start “Image App”

- When the connection confirmation screen appears on the camera, select [Yes] and press [MENU/SET]. (Only when making a connection for the first time.)

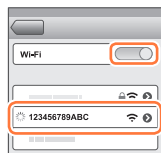

[Wi-Fi Password] is set to [OFF] at the time of purchase.

When you start a Wi-Fi connection, be sure to verify that the device displayed on the camera's connection confirmation screen is really the device you want to connect to. Even if the wrong device is displayed, you will still be connected to it if you select “Yes”. If there seem to be other Wi-Fi enabled devices in the vicinity, we recommend that you set [Wi-Fi Password] to [ON] ([→297](#)).

Connecting the camera to a smartphone

Using a password to set up a connection

When [Wi-Fi Password] is set to [ON], you can strengthen security by using manual input or a QR code for password authentication.

Preparation

(On the camera) Set [Wi-Fi Password] to [ON]. (→297)

■ When reading a QR Code to connect

(On the camera)

MENU → **Setup** → **Wi-Fi** → **Wi-Fi Function** → **New Connection**
→ **Remote Shooting & View**

Ⓐ SSID and Password

Ⓑ QR Code

- The information (QR Code, SSID and Password) required for directly connecting your smartphone to this unit is displayed.
- You can also display the information by pressing [Wi-Fi] button on the camera.

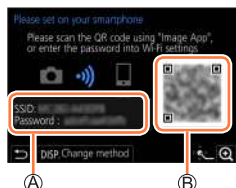

(On your smartphone)

① Start "Image App"

② Select "QR code"

- When the smartphone is connected to a wireless access point, it may take time to display QR code.
- (For iOS devices) A confirmation screen will be displayed. Select [OK] to proceed.

③ Use the "Image App" to scan the QR code displayed on the screen of the camera

- If you press [MENU/SET] on the camera, the QR code will be enlarged.

If you are using an Android device, follow the steps up to here to complete the setup. Proceed to the steps below only if you are using an iOS device (iPhone/iPod touch/iPad).

④ Install the profile

- If the smartphone is locked with a passcode, enter the passcode to unlock the smartphone.

⑤ Exit the browser

⑥ Turn on the Wi-Fi function in the setting menu

⑦ On the Wi-Fi setting screen, select the SSID displayed on the camera

⑧ Start "Image App"

- (iOS devices) Steps ① through ⑤ are not required from the second time on.

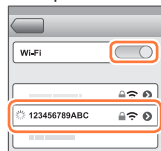

Connecting the camera to a smartphone

■ Manually entering a password to set up a connection

(On the camera)

MENU → **[Setup]** → **[Wi-Fi]** → **[Wi-Fi Function]** → **[New Connection]**
→ **[Remote Shooting & View]**

Ⓐ SSID and Password

Ⓑ QR Code

- The information (QR Code, SSID and Password) required for directly connecting your smartphone to this unit is displayed.
- You can also display the information by pressing **[Wi-Fi]** button on the camera.

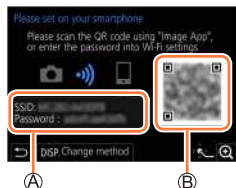

(On your smartphone)

- ① Turn on the Wi-Fi function in the setting menu
- ② On the Wi-Fi setting screen, select the SSID displayed on the camera
- ③ Enter the password displayed on the camera (For first time connection only)
- ④ Start "Image App"



Changing the Wi-Fi connection method

To change the connection method, follow the steps below:

MENU → **[Setup]** → **[Wi-Fi]** → **[Wi-Fi Function]**
→ **[New Connection]** → **[Remote Shooting & View]**
→ **[DISP.]** button

or

Wi-Fi → **[DISP.]** button → **[New Connection]**
→ **[Remote Shooting & View]** → **[DISP.]** button



Connecting the camera to a smartphone

■ When connecting with [Via Network]

(On the camera)

- ① Select [Via Network] and press [MENU/SET]
 - Connect the camera to a wireless access point by following the connection method (→291).

(On your smartphone)

- ② Turn on the Wi-Fi function in the setting menu
- ③ Select the wireless access point you connected to the camera, and set
- ④ Start “Image App”

■ When connecting with [Direct]

(On the camera)

- ① Select [Direct] and press [MENU/SET]
 - Connect the camera to the smartphone by following the connection method (→294).

(On your smartphone)

- ② Start “Image App”

Closing the Wi-Fi connection

1 Set the camera to Recording Mode

- Press the shutter button halfway to return to recording mode.

2 Select the camera's menu items to terminate the Wi-Fi connection

MENU →  [Setup] → [Wi-Fi] → [Wi-Fi Function]
→ [Yes]

- You can also terminate the connection by pressing [Wi-Fi] button on the camera.



3 On the smartphone, close “Image App”

- When recording with 4K Pre-Burst with the smartphone, terminate the connection only after switching to 4K Burst recording by pressing [Q.MENU/↶] button on the camera.



Controlling with a Smartphone

■ Required wireless connectivity mode

The wireless connectivity mode required varies depending on the function to be used after connecting to a smartphone.

Wireless connectivity required	Support for Bluetooth low energy
Bluetooth	Indicates that the function can be used with smartphones that support Bluetooth low energy.
Wi-Fi	Indicates that the function can be used with smartphones that do not support Bluetooth low energy.
Bluetooth Wi-Fi	Indicates that the function can be used with smartphones that support Bluetooth low energy. • Indicates that the function requires you to connect to a smartphone using both Bluetooth and Wi-Fi.

Turning on/off the camera using a smartphone

Wireless connectivity required: **Bluetooth** Wi-Fi

Even when the camera is turned off, you can remotely turn on and operate it from your smartphone. This function allows you to turn on the camera from a distant location and take pictures or view images on the camera even when it is in your bag.



1 Make a Bluetooth connection to the smartphone (→257)

2 Select the camera's menu

MENU → [Setup] → [Bluetooth] → [Remote Wakeup] → [ON]

3 Set the Camera [ON/OFF] switch to [OFF]

4 On the smartphone, start up the "Image App", and set the Bluetooth function to a state in which a connection can be made (standby state)

5 Operate the smartphone

① Select





② Select [Remote operation]

- The camera automatically turns on, allowing it to make a Wi-Fi connection automatically.
 - (iOS devices) Depending on the connection status of the smartphone, you may need to change the connected device on the Wi-Fi setup screen. Follow the on-screen message on the smartphone to change the setting.



Controlling with a Smartphone

■ Turning off the camera with the smartphone

- ① Select []
- ② Select [ OFF]

- When [Remote Wakeup] is set to [ON], the Bluetooth function continues to operate even after the camera is turned off, thus causing the battery to drain.

Operating the shutter button of the camera using a smartphone (remote recording)

Wireless connectivity required: Wi-Fi

1 Connect to a smartphone (→256)

2 Operate the smartphone

If the camera is already connected to the smartphone via Bluetooth, select [] → [Remote operation].

(iOS devices) Depending on the connection status of the smartphone, you may need to change the connected device on the Wi-Fi setup screen. Follow the on-screen message on the smartphone to change the setting.



- ① Select []



- ② Take pictures
 - The recorded images are saved in the camera.
 - Some settings are not available.

■ Setting the higher priority between the camera and smartphone to perform operations

MENU →  [Setup] → [Wi-Fi] → [Wi-Fi Setup] → [Priority of Remote Device]

 [Camera]	<p>Allows you to perform operations with both the camera and the smartphone.</p> <ul style="list-style-type: none"> • The camera's dial settings, etc. cannot be changed with the smartphone.
 [Smartphone]	<p>Allows you to perform operations only with the smartphone during remote recording.</p> <ul style="list-style-type: none"> • The camera's dial can also be operated with the smartphone. • To end remote recording, press any of the buttons on the camera to turn on the screen, and select [Cancel].

- The setting of this function cannot be changed while the connection is active.

Controlling with a Smartphone

- This function is not available in the following cases:
 - Panorama Shot Mode (When [Priority of Remote Device] is set to  ([Smartphone]), you can switch temporarily to Programme AE Mode for remote recording only during remote recording.)
 - When using [Time Lapse Shot]



Using the smartphone to operate the shutter button via a Bluetooth connection only

Wireless connectivity required: **Bluetooth**

1 Make a Bluetooth connection to the smartphone (→257)

2 Operate the smartphone

① Select []

② Select [Shutter Remote Control]



③ Take pictures

- Read the [Help] in the "Image App" menu for further details on how to operate [Shutter Remote Control] of "Image App".
- [Shutter Remote Control] is available only when the Camera [ON/OFF] switch is set to [ON].
- The Live View screen of the camera cannot be viewed on a smartphone.
- When the camera turns off after [Sleep Mode] is activated during recording, select [Shutter Remote Control] again using the smartphone to turn on the camera once more. (This function is enabled only when [Remote Wakeup] is set to [ON] and [Auto Transfer] is set to [OFF].)



[B] (Bulb) (Approximately up to 30 minutes)



You can perform [B] (Bulb) recording when the shutter speed is set to [T] (time) in Manual Exposure Mode.

This function is useful when you take pictures of stars in the night sky or a night scene, since the shutter can be kept open from start of recording to end of recording.

1 Operate the smartphone

① Press [] to start recording (Press and hold [])

② Release your finger from [] to end recording

- Slide [] in the direction of LOCK to record with the shutter button fixed in the fully pressed condition. (Slide [] back in the opposite direction or press the shutter button of the camera to end recording.)
- If Bluetooth is disconnected during the [B] (Bulb) recording, reconnect Bluetooth and perform the operation to end recording using the smartphone.
- "[T] (time)" will be displayed on the camera screen.



Controlling with a Smartphone



■ Reducing the time to recover from Sleep mode

Select the smartphone function to be used as a priority function when waking the camera from [Sleep Mode] with a smartphone.

Preparation

Set [Bluetooth] and [Remote Wakeup] to [ON]. (→264)

MENU →  **[Setup]** → **[Bluetooth]** → **[Returning from Sleep Mode]**

 [Remote / Transfer Priority]	Shortens the time required to wake the camera with [Remote operation] or [Transfer image].
 [Shutter Remote Priority]	Shortens the time required to wake the camera with [Shutter Remote Control].



Playing back or saving images stored on the camera, or uploading them on social media sites

Wireless connectivity required: Wi-Fi

1 Connect to a smartphone (→256)

2 Operate the smartphone

If the camera is already connected to the smartphone via Bluetooth, select [] → [Remote operation].

(iOS devices) Depending on the connection status of the smartphone, you may need to change the connected device on the Wi-Fi setup screen. Follow the on-screen message on the smartphone to change the setting.

① Select []

- You can switch a device of pictures to be displayed using the icon at the top left on the screen. Select [LUMIX] to display a picture saved in the camera.

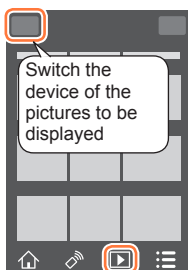

(Playing back a picture)

② When the picture is touched, it is played back at a larger size

- When playing back motion pictures, the data size is reduced during transmission of motion pictures to "Image App". Therefore, the picture quality may be different from the actual motion picture that you have recorded. Depending on your smartphone and its usage environment, you may notice degradation in the picture quality or skipping of sound when playing back motion pictures and still pictures.

(Saving and sending pictures to web services such as SNS)

③ Press and hold the picture and drag it

- AVCHD motion pictures, MP4 motion pictures for which the [Rec Quality] size is [4K], 4K burst files, and pictures recorded with [Post Focus] cannot be saved.
- RAW still pictures can be saved only on smartphones with Android 7.0 or higher or iOS 10.0 or higher. The pictures, however, may not be displayed correctly on some smartphones or some versions of operating systems.



Transferring recorded images to a smartphone automatically

Wireless connectivity required: **Bluetooth** **Wi-Fi**

The camera automatically transfers recorded images to a Bluetooth-connected smartphone via Wi-Fi.

1 Make a Bluetooth connection to the smartphone (→257)

2 Select the camera's menu

MENU →  **[Setup]** → **[Bluetooth]** → **[Auto Transfer]** → **[ON]**

- If a confirmation screen is displayed on the camera asking you to terminate the Wi-Fi connection, select [Yes] to terminate it.

3 On the smartphone, select [YES] (Android devices) or [Wi-Fi Setup] (iOS devices)

- The camera automatically makes a Wi-Fi connection.
 - (iOS devices) Follow the on-screen message on the smartphone to change the connected device on the Wi-Fi setup screen.

4 Check the send settings on the camera, and select [Set]

- To change the send setting, press [DISP.] button. (→278)
- The camera will enter a mode where it can automatically transfer images and  will be displayed on the recording screen. (If [Auto Transfer] is not displayed on the recording screen, images cannot be transferred automatically. Check the status of the Wi-Fi connections to the smartphone.)

5 Take pictures on the camera

- Every time you take a picture, it is automatically sent to a specified device.
- While sending a file,  is displayed on the recording screen.



If you set [Auto Transfer] to [ON] in advance, the Wi-Fi/Bluetooth connection will be automatically established and Auto Transfer enabled the next time you turn on the camera and start up "Image App" on your smartphone.



■ To stop the automatic transfer of images

In step 2, select [OFF].

- A confirmation screen is displayed, asking you to terminate the Wi-Fi connection.

- **When [Auto Transfer] in the [Bluetooth] is set to [ON], [Wi-Fi Function] is disabled.**

- If the file transfer is interrupted because the camera turns off, turn the camera on again to restart file transfer.
 - You may not be able to resend the files that did not get delivered if there is a change in their storage status. For example, if you replace the card before turning on the camera again, the files may not be resent.
 - If the number of files that did not get delivered is large, it may not be possible to resend all of the files.
- Motion pictures, 4K burst files, and pictures recorded with [Post Focus] cannot be automatically transferred.
- RAW still pictures can be saved only on smartphones with Android 7.0 or higher or iOS 10.0 or higher. The pictures, however, may not be displayed correctly on some smartphones or some versions of operating systems.



Writing location information of a smartphone on a recorded image

Wireless connectivity required: **Bluetooth**

The smartphone sends its location information to the camera via Bluetooth, and the camera performs recording while writing the acquired location information.

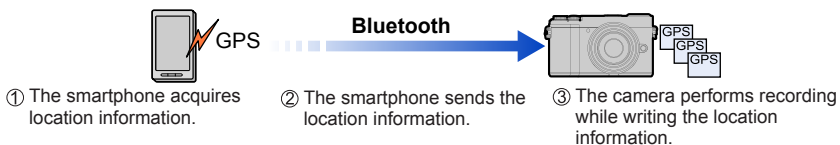

Preparation

Enable the GPS function on the smartphone.

1 Make a Bluetooth connection to the smartphone (→257)

2 Select the camera's menu

MENU → **[Setup]** → **[Bluetooth]** → **[Location Logging]** → **[ON]**

- The camera will enter a mode where location information can be recorded and **[GPS]** will be displayed on the recording screen.

3 Take pictures on the camera

- Location information will be written to the recorded pictures.

When the displayed **[GPS]** is semi-transparent

Location information is not acquired, so data cannot be written. Positioning with the GPS on the smartphone may not be possible if the smartphone is in a location such as a building or a bag. Move the smartphone to a location where positioning performance can be optimised, such as that offers a wide view of the sky, to try positioning. In addition, refer to the operating instructions of your smartphone.

- Images with location information are indicated with **[GPS]**.
- **Be sure to pay special attention to the privacy, the likeness rights, etc. of the subject when you use this function. Use at your own risk.**
- The smartphone battery drains faster while location information is being recorded.
- The location information cannot be written in the following case:
 - Motion pictures recorded in **[AVCHD]** format

Synchronising the camera's clock with a smartphone

Wireless connectivity required: **Bluetooth**

Synchronise the [Clock Set] setting in the [Setup] menu and [Home] or [Destination] setting in the [World Time] of the camera with those of a smartphone.

- 1 Make a Bluetooth connection to the smartphone (→257)
- 2 Select the camera's menu

MENU →  [Setup] → [Bluetooth] → [Auto Clock Set] → [ON]

Combining motion pictures recorded with Snap Movie according to your preference on a smartphone

Wireless connectivity required: **Wi-Fi**

Using a smartphone, you can combine motion pictures recorded with the camera's [Snap Movie] function. Music can be added to motion pictures to be combined. In addition, you can save the combined motion picture or upload it on a web service.

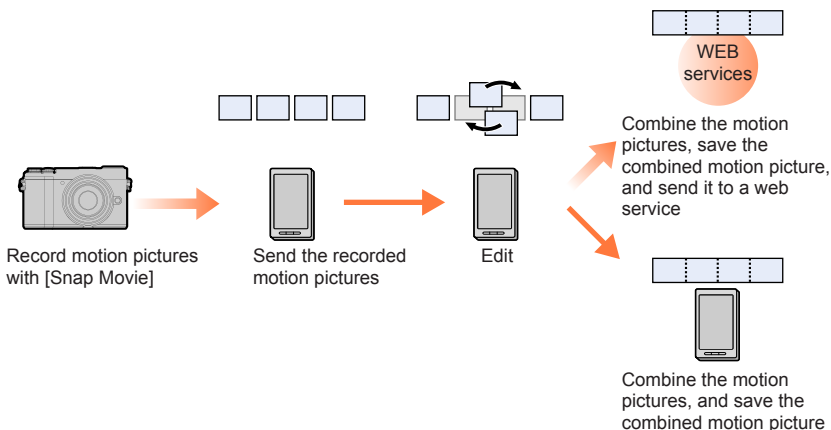

■ Combining motion pictures by operating a smartphone

① Connect to a smartphone (→256)

② Operate the smartphone

If the camera is already connected to the smartphone via Bluetooth, select [] → [Remote operation].

(iOS devices) Depending on the connection status of the smartphone, you may need to change the connected device on the Wi-Fi setup screen. Follow the on-screen message on the smartphone to change the setting.

① Select []



② Select []

- [Snap Movie] motion pictures with recent recording dates will be selected and automatically sent to the smartphone.
- When motion pictures with recent recording dates are not available, a screen that lets you select motion pictures will be displayed. Select motion pictures and send them.

③ Operate the smartphone to edit the motion pictures

- Read the [Help] in the "Image App" menu for further details on how to operate [Snap Movie] of "Image App".

● [Snap Movie] of the "Image App" requires a smartphone that supports Android OS 4.3 or higher.



Displaying still pictures on a TV

You can display still pictures on a TV that is compatible with a DLNA (DMR) function.

MENU →  [Setup] → [Wi-Fi] → [Wi-Fi Function] → [New Connection]
→ [Playback on TV]

1 Select [Via Network] or [Direct] to connect (→291, 294)

2 Select the device you wish to connect to

- When the connection is established, the screen is displayed.

3 Take or play back still pictures on this unit

- To terminate the connection, follow the steps below:

MENU →  [Setup] → [Wi-Fi] → [Wi-Fi Function] → [Yes]

(You can also close the connection by pressing the [Wi-Fi] button.)

- When you display the pictures on a TV using the Wi-Fi function, they are not output using 4K resolution. To output pictures using 4K resolution, connect this unit to the TV using an HDMI micro cable. (→300)
- When a TV is connected to this unit, the TV screen may temporarily return to the status before the connection. Pictures are displayed again when you take or play back pictures.
- Even if [Effect] and [Sound] are set on this unit, these settings are disabled when the pictures are played back on a TV during Slide Show playback.
- Motion pictures and 4K burst files cannot be played back.
- The pictures displayed on “Multi Playback” screen or some screens of the camera are not displayed on the TV.
- When [Auto Transfer] in the [Bluetooth] is set to [ON], [Wi-Fi Function] is disabled.



Sending pictures

When sending pictures, first select [New Connection], then select the method of sending pictures.

MENU →  [Setup] → [Wi-Fi] → [Wi-Fi Function] → [New Connection] → [Send Images While Recording] / [Send Images Stored in the Camera]



■ Images that can be sent

Destination	JPEG	RAW	MP4*1	AVCHD*1, *2	4K Burst File*1 Pictures recorded in [Post Focus]*1
[Smartphone]	○	○*3	○*4	—	—
[PC]	○	○	○	○	○
[Cloud Sync. Service]	○	—	○*4	—	—
[Web service]	○	—	○*4	—	—
[AV device]	○	—	—	—	—
[Printer]*1	○	—	—	—	—

*1 Sending by [Send Images While Recording] is not available.

*2 Files larger than 4 GB cannot be sent.



*3 An Android 7.0 or higher or iOS 10.0 or higher operating system is required.

*4 Excluding motion pictures recorded with [Rec Quality] of [4K].

- Some images may not be played back or sent depending on the device.
- For more information about picture playback, see the operating instructions of the destination device, or check the WEB service to which you will send the pictures.

[Send Images While Recording]

A picture can be automatically sent to a specified device every time you take it.

-  is displayed on the recording screen while connected by [Send Images While Recording], and  is displayed while files are being sent.
- To terminate the connection, follow the steps below:

MENU →  [Setup] → [Wi-Fi] → [Wi-Fi Function] → [Yes]

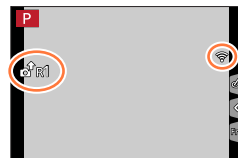

- You cannot change the settings while sending a still picture.

Sending pictures

- Since the camera gives priority to recording, sending may take longer during the recording.
- If you turn off the camera before you have completed sending, or if you close the Wi-Fi connection, or in similar situations, unsent files will not be resent.
- You may not be able to delete files or use the [Playback] menu while sending.
- If you set [Time Lapse Shot], the Wi-Fi connection is terminated and you cannot use this function.

[Send Images Stored in the Camera]

You can select and send recorded images.

When selecting [Single Select]

- ① Select the picture
- ② Select [Set]

**When selecting [Multi Select]**

- ① Select the picture (repeat)
 - If selected again, the setting will be cancelled.
- ② Select [OK]

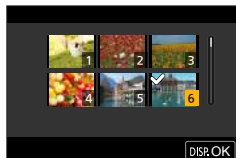

- To close the connection, select [Exit].

- Some images taken with a different camera may not be able to be sent.
- Images that have been modified or edited with a computer may not be able to be sent.



Changing the settings for sending images

After you have completed connecting, you can change the send settings, such as the size of pictures to be sent, by pressing the [DISP.] button.

[Size]	Resize the image to send. [Original] / [Auto] / [Change] ([M], [S], [VGA]) • If you select [Auto], the image size is determined by the circumstances at the destination. Only available when the destination is set to [Web service].
[File Format]	Only available when the destination is set to [PC]. [JPG] / [RAW+JPG] / [RAW]
[Delete Location Data]	Select whether to delete the location information from images before sending them. Only available when the destination is set to [Cloud Sync. Service] or [Web service]. [ON]: Delete the location information, then send. [OFF]: The location information will not be deleted from the original images stored in this unit.
[Cloud Limit]	You can select whether to send images when the Cloud Folder runs out of free space. Only available when the destination is set to [Cloud Sync. Service]. [ON]: Do not send images. [OFF]: Delete images from the oldest ones, then send new images.



Sending pictures to a smartphone

Preparation

Install "Image App" in advance. (→256)

MENU →  **[Setup]** → **[Wi-Fi]** → **[Wi-Fi Function]** → **[New Connection]**
→ **[Send Images While Recording]** / **[Send Images Stored in the Camera]**
→ **[Smartphone]**

1 Select **[Via Network]** or **[Direct]** to connect (→291, 294)

(On your smartphone)

■ When connecting with **[Via Network]**

- ① Set Wi-Fi function to "ON"
- ② Select a wireless access point and set
- ③ Start "Image App"

■ When connecting with **[WPS Connection]*** in **[Direct]**

- ① Start "Image App"

* WPS refers to a function that allows you to easily configure the settings related to the connection and security of wireless LAN devices. To check if the smartphone you are using is compatible with WPS, refer to the instruction manual of the smartphone.

■ When connecting with **[Manual Connection]** in **[Direct]**

- ① Set Wi-Fi function to "ON"
- ② Select the SSID displayed on this unit
- ③ Start "Image App"

2 Select the device you wish to connect to

3 Check the send settings, and select **[Set]**

- To change the send setting, press the **[DISP.]** button. (→278)

[Send Images While Recording]

4 Take a still picture (→276)

[Send Images Stored in the Camera]

4 Select the picture (→277)

- When **[Auto Transfer]** in the **[Bluetooth]** is set to **[ON]**, **[Wi-Fi Function]** is disabled.



Wireless printing

You can print out recorded still pictures wirelessly from a PictBridge (wireless LAN-compatible)* printer.

* Compliant with the DPS over IP standards.

Contact the printer manufacturers for details on PictBridge (wireless LAN-compatible) printers.

MENU →  **[Setup]** → **[Wi-Fi]** → **[Wi-Fi Function]** → **[New Connection]**
→ **[Send Images Stored in the Camera]** → **[Printer]**

1 Select **[Via Network]** or **[Direct]** to connect (→291, 294)

2 Select a printer you want to connect

3 Select the still picture and print

- Pictures are selected the same way as when connecting by USB connection cable. For details (→310).
- To terminate the connection, press [Q.MENU/↶] button.

● When [Auto Transfer] in the [Bluetooth] is set to [ON], [Wi-Fi Function] is disabled.



Sending pictures to AV device

Still pictures and motion pictures can be sent to AV devices in the home (home AV devices), such as DLNA compatible recorders.

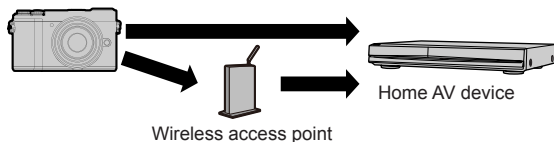

MENU → **Setup** → **Wi-Fi** → **Wi-Fi Function** → **New Connection**
 → **Send Images While Recording** / **Send Images Stored in the Camera**
 → **AV device**

- 1** Select **[Via Network]** or **[Direct]** to connect (→291, 294)
- 2** Select the device you wish to connect to
- 3** Check the send settings, and select **[Set]**
 - To change the send setting, press the **[DISP.]** button. (→278)

[Send Images While Recording]

- 4** Take a still picture (→276)

[Send Images Stored in the Camera]

- 4** Select the picture (→277)

- Sending may fail depending on the operational status of the AV device. Also, sending may take a while.
- When **[Auto Transfer]** in the **[Bluetooth]** is set to **[ON]**, **[Wi-Fi Function]** is disabled.

Sending pictures to a PC

Preparations

- Turn the computer on.
- Prepare folders for receiving images on the PC before sending a picture to the PC (below).
- If the standard settings are changed for the workgroup on the connected PC, you must change settings in [PC Connection] on this unit. (→297)

To create a folder that receives images

- Create a PC user account (account name (up to 254 characters) and password (up to 32 characters)) consisting of alphanumeric characters. An attempt to create a receive folder may fail if the account includes non-alphanumeric characters.

■ When using “PHOTOfunSTUDIO”

- ① Install “PHOTOfunSTUDIO” on the PC (→305)
- ② Create a folder that receives images with “PHOTOfunSTUDIO”
 - For details, refer to the operating instructions of “PHOTOfunSTUDIO” (PDF).

■ When not using “PHOTOfunSTUDIO”

(For Windows)

Supported OS: Windows 10 / Windows 8.1 / Windows 8 / Windows 7

Example: Windows 7

- ① Select a folder you intend to use for receiving, then right-click
- ② Select [Properties], then enable sharing of the folder
 - For details, refer to the operating instructions of your PC or Help on the operating system.

(For Mac)

Supported OS: OS X v10.5 to v10.11, macOS 10.12, macOS 10.13

Example: OS X v10.8

- ① Select a folder you intend to use for receiving, then click on the items in the following order
[File] → [Get Info]
- ② Enable sharing of the folder
 - For details, refer to the operating instructions of your PC or Help on the operating system.



Sending pictures to a PC

MENU →  **[Setup]** → **[Wi-Fi]** → **[Wi-Fi Function]** → **[New Connection]**
 → **[Send Images While Recording]** / **[Send Images Stored in the Camera]**
 → **[PC]**

- 1** Select **[Via Network]** or **[Direct]** to connect (→291, 294)
- 2** Select the **PC** you want to connect to
 - If the PC you want to connect to is not displayed, select **[Manual Input]**, then enter the computer name (for Mac, enter the NetBIOS name).
- 3** Select the folder you want to send to
- 4** Check the send settings, and select **[Set]**
 - To change the send setting, press the **[DISP.]** button. (→278)

[Send Images While Recording]

- 5** Take a still picture (→276)

[Send Images Stored in the Camera]

- 5** Select the picture (→277)

- Folders sorted by the sent date are created in the specified folder, and pictures are saved in those folders.
- If the screen for a user account and password entry appears, enter the one you set on your PC.
- If the computer name (for Mac, the NetBIOS name) contains spaces, etc., the name may not be properly recognised. If you cannot connect, we recommend changing the computer name (for Mac, the NetBIOS name) to a combination of 15 or less alphanumeric characters only.
- If a firewall is enabled by the OS or security software, this unit may be unable to connect to the computer.
- When **[Auto Transfer]** in the **[Bluetooth]** is set to **[ON]**, **[Wi-Fi Function]** is disabled.



Using WEB services

Through "LUMIX CLUB", you can send still pictures and motion pictures to social networking services, etc. By selecting the setting to automatically transfer still pictures and motion pictures to [Cloud Sync. Service], you can receive the transferred still pictures and motion pictures on a PC or a smartphone.

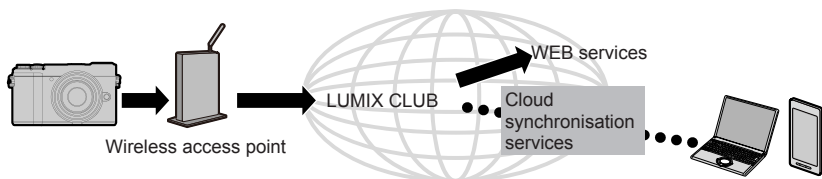

When sending images to WEB service

Preparation

- Register to "LUMIX CLUB" (→288)
- To send images to a WEB service, you need to register the WEB service. (→285)

- **Panasonic assumes no responsibility for the damages resulting from the leakage, loss, etc. of images uploaded on WEB services.**
- **When uploading images to the WEB service, do not delete images from this camera, even after they have finished sending, until you have checked that they have been properly uploaded to the WEB service. Panasonic assumes no responsibility for the damages resulting from the deletion of images stored in this unit.**
- Images uploaded to the WEB service cannot be displayed or deleted with this camera.
- If sending images fails, a report email outlining the failure will be sent to the email address registered with "LUMIX CLUB".



Registering the WEB service to “LUMIX CLUB”

Check the “FAQ/Contact us” on the following site for compatible WEB services.
https://lumixclub.panasonic.net/eng/c/lumix_faqs/

Preparation

Make sure that you have created an account on the WEB service you want to use, and have the login information available.

- 1 Connect to the “LUMIX CLUB” site using a smartphone or computer**
<https://lumixclub.panasonic.net/eng/c/>
- 2 Enter your “LUMIX CLUB” login ID and password and log in to the service**
- 3 If you have not registered your email address with “LUMIX CLUB”, register the email address**
- 4 Select the WEB service to be used for WEB service link settings and register it**
 - Follow the instructions on the screen to register the service.

Sending pictures

MENU →  **[Setup]** → **[Wi-Fi]** → **[Wi-Fi Function]** → **[New Connection]**
 → **[Send Images While Recording]** / **[Send Images Stored in the Camera]**
 → **[Web service]**

- 1 Select [Via Network] and connect (→291)**
- 2 Select a WEB service you want to connect**
- 3 Check the send settings, and select [Set]**
 - To change the send setting, press the [DISP.] button. (→278)

[Send Images While Recording]

- 4 Take a still picture (→276)**

[Send Images Stored in the Camera]

- 4 Select the picture (→277)**

● When [Auto Transfer] in the [Bluetooth] is set to [ON], [Wi-Fi Function] is disabled.

■ Quickly sending pictures in the camera to WEB services

- ① Display the picture
- ② Press **▼**, and then press **◀** to select [Yes]
(When you play back group pictures one by one, press **▲** and then select [Upload(Wi-Fi)] or [Upload All(Wi-Fi)].)
 - The same operation can be performed by touching **[]**.
(When selecting a group picture, touch **[]**, **[]**, **[]**, **[]**, and then **[]**, and then select [Upload(Wi-Fi)] or [Upload All(Wi-Fi)].)
- ③ Select a WEB service you want to connect
- ④ Check the send settings, and select [Set]
 - Step ③, ④ are not necessary when you continue to send another image.
 - To change the transmission setting for the picture, press the [DISP.] button. (→278)
 - To terminate the connection, press [MENU/SET] or operate other controls to exit the playback screen. You can also terminate the connection by pressing [Wi-Fi] button on the camera.



To change the settings for sending images or web service

Terminate the Wi-Fi connection, and follow step ① and onwards again.

- You can also change the send settings by pressing [Wi-Fi] button while using a Wi-Fi connection.

- If the camera has no records of connections to wireless access points that are available, select the connection method and connect the camera to a wireless access point. (→291)
- When you are not registered to "LUMIX CLUB", get a login ID and set a password. (→288)
- When pictures are displayed as a group, they are all sent. When a single picture in a group is displayed, only the picture being displayed is sent.



When sending images to [Cloud Sync. Service]

Preparation

You need to register to "LUMIX CLUB" (→288) and configure the Cloud Sync. setting to send a picture to a Cloud Folder. Use "PHOTOfunSTUDIO" on a PC or "Image App" on a smartphone to configure the Cloud Sync. settings.

■ About the images sent to a Cloud Folder by the use of [Cloud Sync. Service] (Current as of February 2018)

- Sent pictures are temporarily saved in the cloud folder, and they can be synchronised with the device in use, such as the PC or smartphone.
- A Cloud Folder stores transferred images for 30 days (up to 1,000 pictures). Transferred images are deleted automatically 30 days after the transfer. Furthermore, when the number of stored images exceeds 1,000, some images may be deleted depending on the [Cloud Limit] (→278) setting even within 30 days after the transfer.
- When the download of images from a Cloud Folder to all specified devices is complete, images may be deleted from the Cloud Folder even within 30 days after the transfer.

MENU →  **[Setup]** → **[Wi-Fi]** → **[Wi-Fi Function]** → **[New Connection]**
→ **[Send Images While Recording]** / **[Send Images Stored in the Camera]**
→ **[Cloud Sync. Service]**

1 Select **[Via Network]** and connect (→291)

2 Check the send settings, and select **[Set]**

- To change the send setting, press the [DISP.] button. (→278)

[Send Images While Recording]

3 Take a still picture (→276)

[Send Images Stored in the Camera]

3 Select the picture (→277)

- When [Auto Transfer] in the [Bluetooth] is set to [ON], [Wi-Fi Function] is disabled.



About the [LUMIX CLUB]

Acquire a “LUMIX CLUB” login ID (free).

Refer to the “LUMIX CLUB” site for details.
<https://lumixclub.panasonic.net/eng/c/>

Please note;

- The service may be suspended due to regular maintenance or unexpected problems, and service contents may be changed or added to, without prior notice to the users.
- The service may be stopped in whole or in part with a reasonable period of advance notice.

Acquiring a new login ID ([New account])

MENU →  [Setup] → [Wi-Fi] → [Wi-Fi Setup] → [LUMIX CLUB]
 → [Set/Add Account] → [New account]

- Connect to the network. Proceed to the next page by selecting [Next].

1 Select the method for connecting to a wireless access point, and set (→291)

- Proceed to the next page by selecting [Next].

2 Read through the “LUMIX CLUB” terms of use and select [Agree]

- You can press ▲▼ to switch pages.
- Rotate the rear dial to the right to enlarge the page display (x2 magnification). If you rotate the rear dial to the left after enlarging the page, the page returns to its original size (no magnification).
- You can use ▲▼◀▶ to move the position of the area to be enlarged.
- Press [Q.MENU/⏮] button to cancel the process without acquiring a login ID.

3 Enter the password

- Enter any combination of 8 to 16 characters and numbers for the password.
- For details on how to enter characters, refer to “Entering Text” (→63)

4 Check the login ID and select [OK]

- The login ID (12-digit number) will be displayed automatically.
- When logging in to the “LUMIX CLUB” with a computer, you only need to enter the numbers.
- Be sure to make a note of the login ID and password.

Confirming and changing login ID and password ([Set Login ID])

Preparation

To use a previously acquired login ID, confirm your ID and password.

To change the "LUMIX CLUB" password on the camera, access the "LUMIX CLUB" website from your smartphone or PC and change the "LUMIX CLUB" password in advance.

MENU →  [Setup] → [Wi-Fi] → [Wi-Fi Setup] → [LUMIX CLUB]
→ [Set/Add Account] → [Set Login ID]

- The login ID and password are displayed.
- The password is displayed as "★".

1 Select the item you wish to change

2 Enter your login ID or password

- For details on how to enter characters, refer to "Entering Text" (→63)
- Enter the new password you have created on your smartphone or PC into the camera.

3 Select [Exit]

To set the same login ID for the camera and the smartphone

Setting the same login ID on this unit and your smartphone is convenient for sending images on this unit to other devices or WEB services.

■ When either this unit or the smartphone has acquired the login ID

- ① Connect this unit to the smartphone (→260)
- ② From the "Image App" menu, set the common login ID

- After connecting this unit to the smartphone, the setup screen for a common login ID may appear when you display the playback screen.

■ When this unit and the smartphone have acquired different login IDs

Change the login ID and password of either device.

- To change the camera's login ID and password: (→289)

Check the “LUMIX CLUB” terms of use

Check the details if the terms of use have been updated.

MENU →  **[Setup]** → **[Wi-Fi]** → **[Wi-Fi Setup]** → **[LUMIX CLUB]** → **[Terms of use]**

Delete your login ID and account from the “LUMIX CLUB”

Delete the login ID from the camera when transferring it to another party or disposing of it. You can also delete your “LUMIX CLUB” account.

- Changes and other actions to login IDs can only be made to the login ID acquired with the camera.

MENU →  **[Setup]** → **[Wi-Fi]** → **[Wi-Fi Setup]** → **[LUMIX CLUB]**
→ **[Delete account]**

- 1 Select [Yes] in the login ID delete confirmation screen**
 - The message is displayed. Select [Next].
- 2 Select [Yes] on the confirmation screen for deleting the “LUMIX CLUB” account**
 - The message is displayed. Select [Next].
 - If you want to continue using the service, selecting [No] will only delete the login ID.
- 3 Select [Next]**

About Wi-Fi connections

The following types of connections are available.

MENU →  **[Setup]** → **[Wi-Fi]** → **[Wi-Fi Function]**

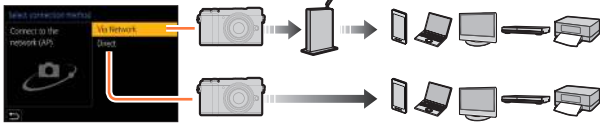
<p>[New Connection]</p>	<p>A connection is made by selecting a Wi-Fi function and the connected device. When the following screen is displayed, select either [Via Network] (→291) or [Direct] (→294) and make a connection.</p> <p style="text-align: center;">Wireless access point</p> 
<p>[Select a destination from History] / [Select a destination from Favorite]</p>	<p>Connection is made using the same settings as the previous time. (→295)</p>

Connecting via a wireless access point ([Via Network])

Select a connection method to the wireless access point.

<p>[WPS (Push-Button)]</p>	<p>Save push button type wireless access point that is compatible with Wi-Fi Protected Setup™ with a WPS mark.</p> <p>1 Press the wireless access point WPS button until it switches to WPS Mode</p>
<p>[WPS (PIN code)]</p>	<p>Save PIN code type wireless access point that is compatible with Wi-Fi Protected Setup with a WPS mark.</p> <p>1 On the camera screen, select the wireless access point you are connecting to</p> <p>2 Enter the PIN code displayed on the camera screen into the wireless access point</p> <p>3 Press [MENU/SET] on the camera</p>
<p>[From List]</p>	<p>Select this option when you are not sure about the WPS compatibility, or when you want to search for and connect to a wireless access point. (→292)</p>

About Wi-Fi connections

- The settings screen will only appear during the first connection. Connection methods set on this unit are stored and will be used for subsequent connections. If you want to change the wireless access point to connect to, press the [DISP.] button, then change the connecting destination.
- WPS refers to a function that allows you to easily configure the settings related to the connection and security of wireless LAN devices. To check if the wireless access point you are using is compatible with WPS, refer to the instruction manual of the wireless access point.

If you are not sure about the WPS compatibility (connecting by [From List])

Search for available wireless access points.

- Confirm encryption key of the selected wireless access point if the network authentication is encrypted.

1 Select the wireless access point you are connecting to

- Pressing [DISP.] button will search for a wireless access point again.
- If no wireless access point is found, refer to “When connecting with [Manual Input]”.



2 (If network authentication is encrypted) Enter the encryption key

- For details on how to enter characters, refer to “Entering Text” (→63)



■ When connecting with [Manual Input]

- When connecting by [Manual Input], confirm SSID, network authentication type, encryption type, encryption key of the wireless access point you are using.
- ① On the screen of step **1** of “If you are not sure about the WPS compatibility (connecting by [From List])”, select [Manual Input]
 - ② Enter the SSID of the wireless access point you are connecting to, then select [Set]
 - For details on how to enter characters, refer to “Entering Text” (→63)
 - ③ Select the network authentication type

[WPA2-PSK]	Supported encryption methods: [TKIP] / [AES]
[WPA2/WPA-PSK]	
[No Encryption]	—

- ④ (When an option other than [No Encryption] is selected)
Enter the encryption key

- Check the wireless access points instruction manual and settings when saving a wireless access point.
- If no connection can be established, the wireless access point's radio waves may be too weak. Refer to “Message displays” (→323) and “Q&A Troubleshooting” (→329) for details.
- Transmission speed may decrease, or may not be usable depending on the environment it is used in.

Connecting directly ([Direct])

You can directly connect the camera to your device.

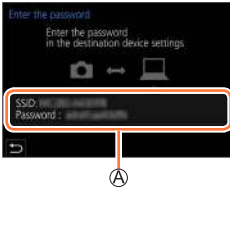
[WPS Connection]	<p>[WPS (Push-Button)]</p> <ol style="list-style-type: none"> 1 On the camera screen, select [WPS (Push-Button)] 2 Set the device to WPS mode <ul style="list-style-type: none"> You can extend waiting time for a connection by pressing the [DISP.] button on this unit. <p>[WPS (PIN code)]</p> <ol style="list-style-type: none"> 1 On the camera screen, select [WPS (PIN code)] 2 Enter the PIN code of the device into the camera 	
[Manual Connection]	<ol style="list-style-type: none"> 1 Enter the SSID and password into the device. The SSID and password are displayed on the connection waiting screen of this unit <ul style="list-style-type: none"> Ⓐ SSID and Password <ul style="list-style-type: none"> If a device to be connected is [Smartphone], the password is not displayed. Select SSID to connect. (→260) 	

- Read the operating instructions of your device for details.

Connecting quickly with the same settings as used previously ([Select a destination from History] / [Select a destination from Favorite])

The camera keeps a History of times you used the Wi-Fi function. You can register items in the History to Favourite.

You can easily connect with the same settings as used previously by connecting from History or Favourite.

- If the Wi-Fi settings of the device to connect to have been changed, it may not be possible to connect to the device.

1 Set the menu

MENU →  [Setup] → [Wi-Fi] → [Wi-Fi Function]

[Select a destination from History]	Connects using the same settings as used previously.
-------------------------------------	--

[Select a destination from Favorite]	Connects using settings registered in Favourite.
--------------------------------------	--

2 Select the desired connection setting

- When selecting History or Favourite items, you can view connection details by pressing the [DISP.] button.

Registering History items to Favourite

MENU →  [Setup] → [Wi-Fi] → [Wi-Fi Function]
→ [Select a destination from History]

1 Select the item you wish to register and press ►

2 Enter a registration name

- For details on how to enter characters, refer to "Entering Text" (→63)
- Up to 30 characters can be entered. A double-byte character will be treated as two characters.



Editing items registered in Favourite

MENU →  **[Setup]** → **[Wi-Fi]** → **[Wi-Fi Function]**
→ **[Select a destination from Favorite]**

1 Select the Favourite item you wish to edit and press ►

[Remove from Favorite]	—
[Change the Order in Favorite]	Select the destination.
[Change the Registered Name]	<ul style="list-style-type: none"> For details on how to enter characters, refer to “Entering Text” (→63)

- The number of settings that can be saved in the history is limited. Register and save frequently used Wi-Fi connection settings to Favourites.
- Performing [Reset Wi-Fi Settings] deletes content registered in History and Favourite.
- If the device you want to connect to (smartphone, etc.) is connected to a wireless access point other than the camera, you cannot connect the device to the camera using [Direct]. Change the Wi-Fi settings of the device you want to connect to so that the access point to be used is set to the camera.
You can also select [New Connection] and reconnect the devices. (→291)
- When connecting to a network to which many PCs are connected, it may be difficult to make the connection because the camera searches for previously connected equipment out of a large number of equipment pieces. If you cannot connect, retry the connection using [New Connection].



[Wi-Fi Setup]

Configure the settings required for the Wi-Fi function.
[Wi-Fi Setup] cannot be changed when connected to Wi-Fi.

[MENU] →  **[Setup]** → **[Wi-Fi]** → **[Wi-Fi Setup]**

[Priority of Remote Device]	(→265)
[Wi-Fi Password] You can improve security by enabling password entry for a direct connection to a smartphone.	[ON]: Connects the camera and a smartphone using an SSID and password. (→261) [OFF]: Connects the camera and a smartphone using an SSID. (→260) <hr/> <ul style="list-style-type: none"> • When [ON] is selected, you can also set up a connection by scanning a QR code.
[LUMIX CLUB]	Acquires or changes the "LUMIX CLUB" login ID. (→288)
[PC Connection] You can set the workgroup.	You must connect to the same workgroup as the destination computer when sending pictures to the computer. (The default is set to "WORKGROUP") ① Press [MENU/SET] ② Enter the workgroup of the connecting PC <hr/> <ul style="list-style-type: none"> • For details on how to enter characters, refer to "Entering Text" (→63) • Pressing [DISP.] button will return the default setting
[Device Name] You can change the name (SSID) of this unit.	① Press [DISP.] button ② Enter the desired device name (Up to 32 characters can be entered) <ul style="list-style-type: none"> • For details on how to enter characters, refer to "Entering Text" (→63)
[Wi-Fi Function Lock] To prevent incorrect operation or use of the Wi-Fi function by a third party and to protect saved personal information, it is recommended that you protect the Wi-Fi function with a password.	[Setup]: Enter any 4-digit numbers as the password. [Cancel] <hr/> <ul style="list-style-type: none"> • For details on how to enter characters, refer to "Entering Text" (→63) • If you forget the password, you can reset it with [Reset Network Settings] (→232) in the [Setup] menu.
[Network Address] Displays the MAC address and IP address of this unit.	<ul style="list-style-type: none"> • A "MAC Address" is a unique address that is used to identify network equipment. • "IP address" refers to a number that identifies a PC connected to a network such as the Internet. Usually, the addresses for homes are automatically assigned by the DHCP function such as a wireless access point. (Example: 192.168.0.87)



Enjoying 4K motion pictures

Viewing 4K motion pictures

■ Viewing on TV screen

When you connect this unit to a 4K-compatible TV and play back a motion picture recorded with [Rec Quality] of [4K], you can enjoy high-resolution 4K motion pictures. Although resolution output will be lower, you can also play back 4K motion pictures by connecting to a high-definition TV and other devices that do not have 4K support.

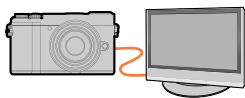

Preparations

- Set [HDMI Mode (Play)] (→229) to [AUTO] or [4K/25p].
- When connecting to a TV that does not support 4K motion picture, select [Auto].

① Connect this unit to a 4K-compatible TV using an HDMI micro cable and display the playback screen (→300)

- When the [VIERA Link] setting on the camera is set to [ON] and the camera is connected to a VIERA Link (HDMI)-compatible Panasonic television (VIERA), the television automatically switches its input and the playback screen is displayed. For details (→303).
- When you have motion pictures recorded with [Rec Format] set to [MP4] and their size set to [4K] in [Rec Quality], you can also play them back by inserting the card into the SD card slot of a TV that supports motion pictures in 4K.
- Read the operating instructions for the TV.

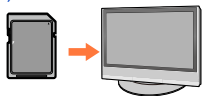

■ Viewing 4K motion pictures on a PC screen

To play back motion pictures recorded with [Rec Quality] of [4K] on a PC, use the software "PHOTOfunSTUDIO".

- To play back and edit 4K motion pictures, a high-performance PC environment is required.
- For details, refer to the operating instructions of "PHOTOfunSTUDIO" (PDF).



Storing 4K motion pictures

You cannot dub 4K motion pictures to a Blu-ray disc or DVD using a Panasonic recorder.

■ Storing 4K motion pictures on your PC

You can use the software "PHOTOfunSTUDIO" to import 4K motion pictures to a PC.

- For details, refer to the operating instructions of "PHOTOfunSTUDIO" (PDF).



Viewing on TV screen

Preparation

Turn off both camera and TV.

1 Connect camera to TV

- To open the socket cover (→24)
- Check the plug direction and insert it straight in. (If the cable is inserted in the wrong direction, the plug could become deformed and cause faulty operation.) Also, do not insert into the wrong socket. Doing so may cause damage to this unit.

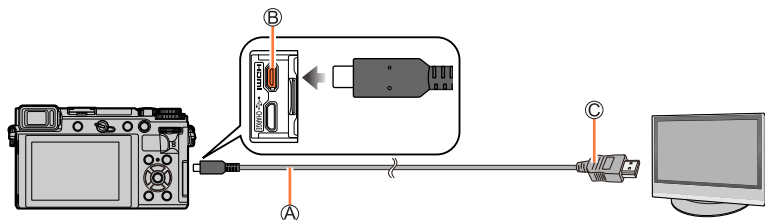

A HDMI micro cable

Use a "High Speed HDMI micro cable" with the HDMI logo.

Cables that do not comply with the HDMI standards will not work.

"High Speed HDMI micro cable" (Type D - Type A plug, up to 2 m (6.6 feet) long)

B [HDMI] socket

C To HDMI video/audio input socket

2 Turn on the TV and switch the TV input source to match the connection socket

3 Turn on the camera and press [▶] (Playback) button



Viewing on TV screen

- Bars may appear at the sides or at the top and bottom of the screen, depending on the aspect ratio setting.
- Change the screen mode on your TV if the picture is displayed with the top or bottom cut off.
- Depending on the TV to be connected, motion picture files or 4K burst files may not be played back correctly.
- Check the [HDMI Mode (Play)]. (→229)
- To play back 24p motion pictures, set [HDMI Mode] to [AUTO]. Otherwise, the picture is not output at 24 frames per second.
- Pictures are not displayed on the camera screen. Also, sound is not produced from the camera's speaker.
- HDMI output will be cancelled if a USB connection cable (supplied) is connected simultaneously.
- Read the operating instructions for the TV.

**The recorded pictures can be played back on a TV with an SD Memory Card slot**

- Proper playback (aspect ratio) will be dependent on the TV used for viewing.
- The file format of the motion pictures that can be played back differs depending on the TV model.
- You may not be able to play back panorama pictures. Also you cannot perform automatic scrolling playback of panorama pictures.
- For cards compatible with playback, refer to the operating instructions of the TV.



Recording while monitoring camera images

When using the HDMI output, you can record still pictures and motion pictures while monitoring the camera image on a TV, etc.



Switching the information displayed

You can change the display shown during HDMI output using [HDMI Info Display (Rec)] in [TV Connection] on the [Setup] menu.

[ON]: The camera display is output as is.

[OFF]: Only images are output.

- When you use the HDMI output during recording, the output image quality will be automatically switched to match the connected device.
 - However, in the following cases, the [Rec Quality] setting in the [Motion Picture] menu is applied to the output images. (If the connected device does not support the setting, the optimal setting for the device will be automatically selected for the HDMI output image quality.)
 - During motion picture recording
 - Creative Video Mode
 - When [Rec Area] is set to []
- If you use the HDMI output during recording, aspect ratio setting is fixed to [16:9].
- When the camera is connected to an external monitor or a TV that supports 4K motion picture, if you use one of the following settings, the angle of view becomes even narrower than normal:
 - [4K/100M/25p], [4K/100M/30p] or [4K/100M/24p] in [Rec Quality]
 - [4K Live Cropping]
- When using the Auto Focus Mode [] or MF assist, the screen cannot be enlarged in windowed mode.
- [Ex. Tele Conv.] ([Motion Picture]) is not available. (Except in Creative Video Mode)
- An electronic sound or shutter sound will not sound.
- When you check the image and sound from the TV connected to the camera, the microphone of the camera may pick up the sound from the speakers of the TV, producing an abnormal sound (audio feedback). If this occurs, move the camera away from the TV or lower the volume on the TV.
- If you set up a Wi-Fi connection while using the HDMI output, no image will be displayed on the camera monitor.
- Some of setting screens are not output through the HDMI connection.
- This function is not available in the following cases:
 - During panorama picture recording
 - When recording 4K photos
 - When recording using [Post Focus]

VIERA Link (HDMI) (HDAVI Control™)

What is VIERA Link (HDMI)?

- VIERA Link is a function that automatically links this camera to VIERA Link-compatible devices by connecting HDMI micro cables for enabling easy operation with the VIERA remote control. (Some operations are not available.)
- VIERA Link (HDMI) is an exclusive Panasonic function added to the industry-standard HDMI control functions known as HDMI CEC (Consumer Electronics Control). Operation is not guaranteed when connecting with non-Panasonic HDMI CEC-compatible devices. Refer to your product manual to verify compatibility with VIERA Link (HDMI).
- This camera supports VIERA Link (HDMI) Version 5. This is the Panasonic standard that also supports previous Panasonic VIERA Link devices.

Preparation

Set [VIERA Link] to [ON] (→229).

- 1 Connect the camera to a VIERA Link (HDMI)-compatible Panasonic television (VIERA) with an HDMI micro cable (→300)**
- 2 Turn on the camera and press [▶] (Playback) button**
- 3 Operate with the remote control for the TV**

Turning the unit OFF

- The camera can also be turned off when the television is turned off with the remote control.

Automatic input select

- When the camera and TV are connected by HDMI micro cable, the camera is turned ON, and the camera's [▶] (Playback) button is pressed, the television input automatically switches to the camera's screen. The television can also be switched on via the camera from Standby Mode (if "Power on link" on the television is set to "on").

- Operations via the camera buttons will be limited.
- To play back the audio of the motion pictures in a slide show, set the [Sound] in the Slide Show setting screen to [AUTO] or [Audio].
- Use a "High Speed HDMI micro cable" with the HDMI logo.
Cables that do not comply with the HDMI standards will not work.
"High Speed HDMI micro cable" (Type D - Type A plug, up to 2 m (6.6 feet) long)
- If VIERA Link (HDMI) does not function correctly (→331)



Storing recorded still pictures and motion pictures on your PC

Still/motion pictures can be copied from the camera to your computer by connecting the two together.

- Some computers can read directly from the camera's memory card.
For details, see the instruction manual for your computer.

■ Computer specifications

You can connect the camera to a computer that can detect a mass storage device (device that stores a large volume of data).

- Windows: Windows 10 / Windows 8.1 / Windows 8 / Windows 7
- Mac: OS X v10.5 - v10.11, macOS 10.12, macOS 10.13



Some motion pictures recorded in [AVCHD] may not be scanned correctly by copying a file or folder

- When using Windows, be sure to use the "PHOTOfunSTUDIO" software to copy motion pictures recorded in [AVCHD].
- When using Mac, you can copy motion pictures recorded in [AVCHD] using "iMovie". Note, however, that it may not be possible to copy pictures depending on the picture quality settings.
(For details about iMovie, please contact Apple Inc.)



Storing recorded still pictures and motion pictures on your PC

Downloading software

- To download the software, the PC must be connected to the Internet.
- It may take time to download the software in some communication environments.
- Supported OS versions as of February 2018. Supported OS versions may be changed without prior notice.

PHOTOfunSTUDIO 10.0 AE

You can capture still pictures or motion pictures to your PC, or organise captured pictures by categorising by recording date, model name of the digital camera used to record, etc. You can also correct still pictures, edit motion pictures, or write to DVD.

Check the website below to download/install the software.

The software is available for download until the end of March 2023.

http://panasonic.jp/support/global/cs/soft/download/d_pfs10ae.html

• Operating environment

Supported OS	Windows® 10 (32-bit/64-bit) Windows® 8.1 (32-bit/64-bit) Windows® 7 (32-bit/64-bit) SP1 • To support 4K motion pictures or 4K photos, you need the 64-bit version OS of Windows 10, Windows 8.1 or Windows 7.
CPU	Pentium® 4 2.8 GHz or higher
Display	1024×768 pixels or more (1920×1080 pixels or more recommended)
RAM	1 GB or more (32-bit) / 2 GB or more (64-bit)
Free hard disk space	450 MB or more for installing software

- For further information on the operating environment required for the playback and edit functions of 4K motion pictures and for the 4K photo cropping function, refer to the operating instructions for “PHOTOfunSTUDIO” (PDF file).
- “PHOTOfunSTUDIO” is not compatible with Mac.



Storing recorded still pictures and motion pictures on your PC

SILKYPIX Developer Studio SE

This software develops and edits RAW file pictures. Edited pictures can be saved in a file format such as JPEG or TIFF that can be displayed on a PC, etc.

Check the website below to download/install the software.

<http://www.isl.co.jp/SILKYPIX/english/p/>

- **Operating environment**

Supported OS	Windows® 10 Windows® 8.1 Windows® 8 Windows® 7 Mac OS X v10.6 - v10.11, macOS 10.12, macOS 10.13
---------------------	--

- For details on the operating environment and how to use the SILKYPIX Developer Studio, refer to the “Help” or the Ichikawa Soft Laboratory’s support website.

LoiLoScope 30 day full trial version

(Windows 10 / 8.1 / 8 / 7)

Motion pictures can be edited easily.

Check the website below to download/install the software.

<http://loilo.tv/product/20>

- For more information on how to use LoiLoScope and its operating environment, read the LoiLoScope manual available for download at the website.
- “LoiLoScope” is not compatible with Mac.



Storing recorded still pictures and motion pictures on your PC

Copying still pictures and motion pictures

Preparations

- Install "PHOTOfunSTUDIO" on your computer before starting the copying procedure. (→305)
- Turn on the camera and computer.

1 Connect camera to computer

- To open the socket cover (→24)
- Check the plug direction and insert it straight in. (If the cable is inserted in the wrong direction, the plug could become deformed and cause faulty operation.) Also, do not insert into the wrong socket. Doing so may cause damage to this unit.
- Do not use any other USB connection cables except the supplied one.

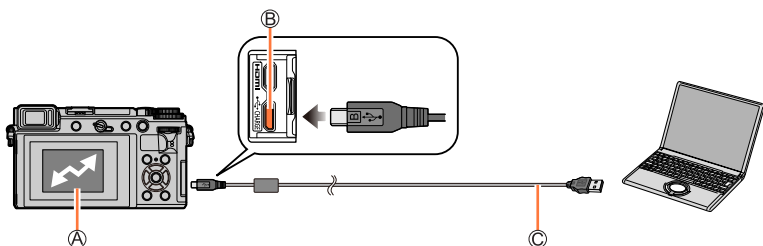

(A) [Access]

- Do not disconnect the USB connection cable (supplied) while [Access] is displayed.

(B) [USB/CHARGE] socket

(C) USB connection cable (supplied)

2 Use ▼ to select [PC(Storage)] and press [MENU/SET]

- If you set the [USB Mode] to [PC(Storage)] in the [Setup] menu in advance, the camera will be automatically connected to the PC without displaying the [USB Mode] selection screen.

3 Use "PHOTOfunSTUDIO" to copy pictures to your computer

- Do not delete or move copied files and folders using Windows Explorer or other browsers. Otherwise, you will not be able to play back or edit the files using "PHOTOfunSTUDIO".

- Before inserting or removing a card, turn the camera off and disconnect the USB connection cable. Otherwise, data may be destroyed.
- Use a battery with sufficient battery power or the AC adaptor (optional) and DC coupler (optional).
- When the battery begins to run out during communication, a warning beep sounds. Remove the USB connection cable safely. Otherwise, data may be destroyed.

Storing recorded still pictures and motion pictures on your PC

■ Copying to your computer without using “PHOTOfunSTUDIO”

You can save pictures to use on your computer by dragging and dropping folders and files into separate folders on your computer.

- The card of this unit contains the following files (folder structure).

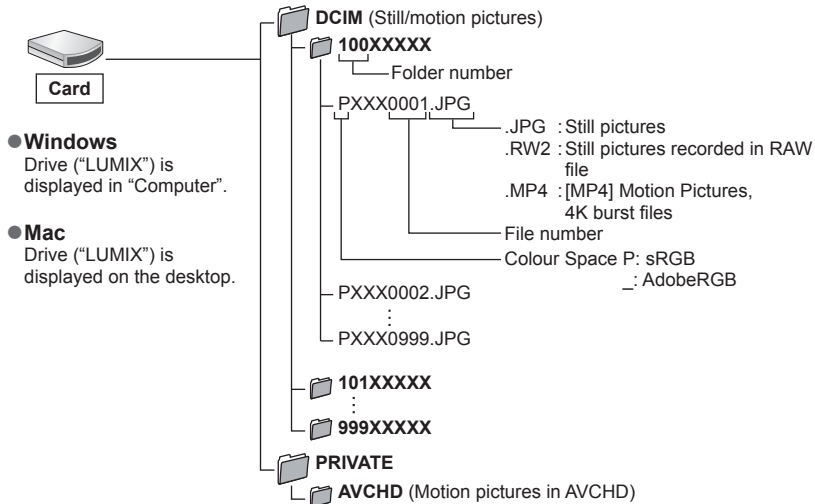

Storing recorded still pictures and motion pictures in the recorder

If you insert a card that has pictures recorded with this camera into a Panasonic recorder, you can dub the content to a Blu-ray Disc or DVD etc.

- The method of importing still pictures and motion pictures recorded in this unit to other devices will vary depending on the file format (JPEG, RAW, AVCHD, or MP4).
- See the instruction manual for the recorder for details for copying and playing back.

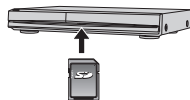

Printing

You can connect a camera directly to a PictBridge-compatible printer for printing.

Preparations

- Adjust the print quality or other settings on your printer, as needed.
- Turn on the camera and printer.

1 Connect camera to printer

- To open the socket cover (→24)
- Check the plug direction and insert it straight in. (If the cable is inserted in the wrong direction, the plug could become deformed and cause faulty operation.) Also, do not insert into the wrong socket. Doing so may cause damage to this unit.
- Do not use any other USB connection cables except the supplied one.

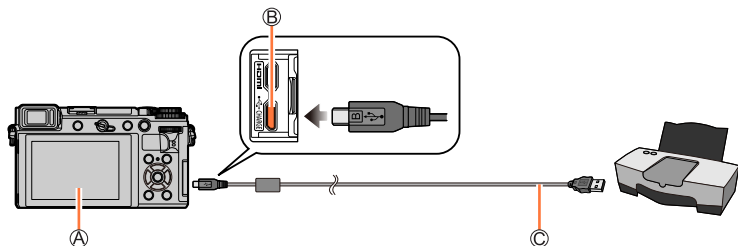

- A [🚫]
- Do not disconnect the USB connection cable (supplied) when the cable disconnection icon [🚫] is displayed (may not be displayed with some printers).
- B [USB/CHARGE] socket
- C USB connection cable (supplied)

2 Use ▲ to select [PictBridge(PTP)] and press [MENU/SET]

3 Use ◀▶ to select a picture and press [MENU/SET]

4 Use ▲ to select [Print start] and press [MENU/SET]



Printing multiple pictures

Multiple pictures are printed at one time.

1 Press **▲** to select **[Multi Print]** in step **3** of “Printing” (→310)

2 Use **▲ ▼** to select the item and press **[MENU/SET]**

[Multi Select]	① Scroll between pictures with ▲ ▼ ◀ ▶ , select pictures to print with [MENU/SET] (Press [MENU/SET] again to release selection.) ② Press [DISP.] button to execute
[Select All]	Print all pictures.
[Rating]	Print pictures selected as [Rating] .

3 Use **▲** to select **[Print start]** and press **[MENU/SET]**

- The group pictures are displayed one by one instead of all pictures at the same time.
- Use a battery with sufficient battery power or the AC adaptor (optional) and DC coupler (optional). When the battery begins to run out during communication, a warning beep sounds. Cancel printing and disconnect USB connection cable (supplied).
- Before inserting or removing a card, turn the camera off and disconnect the USB connection cable.
- Some printers can print directly from the camera's memory card. For details, see the manual for your printer.
- A yellow “●” displayed during printing indicates an error message.
- Print may be divided into several pictures if printing a large amount of pictures. (Remaining sheets display may differ from the number of pictures set for printing.)
- Motion pictures, 4K burst files, and pictures recorded with **[Post Focus]** cannot be printed.
- Still pictures recorded in a RAW file cannot be printed. (The still pictures recorded in JPEG file format at the same time as the RAW file can be printed.)



■ Making print settings on the camera

Setting options include the number of printed pictures and their size. Make settings before selecting [Print start].

[Print with Date]	[ON] / [OFF]
[Num.of prints]	Sets number of pictures (up to 999 pictures).
[Paper Size]	Sets the paper size.
[Page Layout]	Sets whether or not to add borders and how many pictures to be printed on each sheet of paper.

- If the printer does not support date printing, the date cannot be printed on the picture.
- When setting [Print with Date] to [ON], check the date printing settings on the printer (printer settings may be prioritised).
- Items may not be displayed if incompatible with printer.
- To print to paper sizes/layouts not supported by this camera, set to [] and make settings on the printer. (Consult your printer's operating manual.)

■ Printing with date and text

Time and date can be set to be printed on the picture when taking the picture by activating the [Text Stamp] function in the [Playback] menu. (→246)

■ Printing date without [Text Stamp]

Printing in store:

Only recording date can be printed. Request date printing in store.

- The characters entered for [Age] or [Name] of [Profile Setup] or [Face Recog.], [Location] in [Travel Date], and [Title Edit] cannot be printed at a store.

Using printer:

Recording date can be printed by setting [Print with Date] (→312) to [ON] when connecting to a printer compatible with date printing.

Print settings for recording date and text information can be made using "PHOTOfunSTUDIO" software.



Optional accessories

External Flash (optional)

After attaching the flash (DMW-FL200L, DMW-FL360L, DMW-FL580L: optional), the effective range will be increased when compared to the camera's built-in flash.



Preparation

Close the built-in flash and set the Camera [ON/OFF] switch to [OFF].

Removing the hot shoe cover

The hot shoe cover is already attached to the hot shoe at the time of purchase.

Remove the hot shoe cover by pulling it in the direction indicated by arrow ② while pressing it in the direction indicated by arrow ①

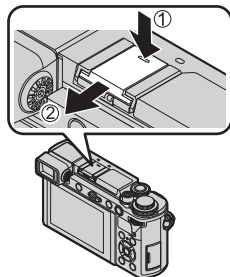

1 Attach the external flash to the hot shoe and then turn on the camera and the external flash

- Refer to (→163) for changing the settings for external flashes on the camera.
- Refer to (→168) about the settings for the wireless flash.



When using other commercially available external flashes that don't offer direct communication with the camera (DC-GX9)

- It is necessary to set the exposure on the external flash when it is used. When you use an external flash in Auto Mode, use an external flash that allows you to set the aperture value and ISO sensitivity to match the same settings on the camera.
- Set the camera to Aperture-Priority AE Mode or Manual Exposure Mode and then set the same aperture value and ISO sensitivity on the external flash. (The proper exposure cannot be achieved because the aperture value changes in Shutter-Priority AE Mode. The light of the external flash cannot be properly adjusted since the aperture value cannot be fixed in Programme AE Mode.)



- When the external flash is attached, the following functions are available even when using the flash.
 - Aperture Bracket
 - Focus Bracket
- You can set the aperture value, shutter speed and ISO sensitivity on the camera even when the external flash is attached.
- Some commercially available external flashes have synchro terminals with high-voltage or reversed polarity. If such flashes are used, they could cause a malfunction or hinder normal operation of the camera.
- Be sure to hold both the camera and the external flash when it is attached to the camera. If you hold only the external flash, it could become detached from the camera.
- If you take pictures close to the subject while taking wide-angle pictures, the light of the flash is obstructed by the lens and the bottom of the screen may be dark.
- Refer to the operating instructions of the external flash for further details.

AC adaptor (optional) / DC coupler (optional)

By using the AC adaptor (optional) and DC coupler (optional), you can record and play back without worrying about the remaining battery charge.

The optional DC coupler can only be used with the designated Panasonic AC adaptor.

- Always use a genuine Panasonic AC adaptor (optional).
- Also read the AC adaptor and DC coupler operating instructions.



List of monitor/viewfinder displays

- The following images are examples of when [Monitor Disp. Set] is set to [] (monitor style) in the monitor.
- The information displayed, such as histograms, magnifications, and numeric values, are only for the purpose of reference.



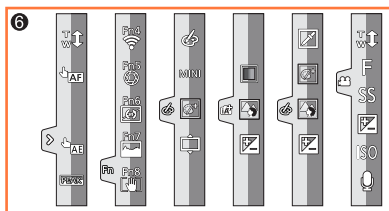
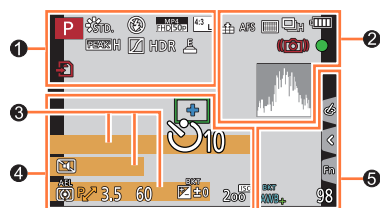























In recording



	Recording mode (→47)
	Custom Set (→93)
	[Photo Style] (→192)
	Flash setting (→163, 164, 166, 169)
	Extra Tele Conversion (when recording motion pictures) (→156)
	[Rec Format]/[Rec Quality] (→173)
	[Snap Movie] (→177)
	[Aspect Ratio] (→189)/ [Picture Size] (→190)
	Extra Tele Conversion (when taking still pictures) (→156)
	Image size (Panorama Shot Mode) (→76)
	Picture effect (Filter) adjustment display (→84, 194)
	Types of picture effects (Filter) (→194)

	[Loop Recording(4K PHOTO)] (→123)
	Card (displayed only during recording) (→33)
	Elapsed recording time*1 (→171)
	Simultaneous recording indicator (→176)
	Automatic switching between viewfinder and monitor (→45)
	[Peaking] (→215)
	[Highlight Shadow] (→197)
	[HDR] (→203)/[iHDR] (→67)
	[Multi Exp.] (→204)
	[Digital Zoom] (→158)
	Electronic shutter (→201)
	Picture-taking during motion picture recording (Photo Priority) (→176)
	Overheat indicator (→326)

List of monitor/viewfinder displays

2	 RAW	[Quality] (→190)
	AFS AFF AFC MF	Focus Mode (→96, 108)
	BKT AFS	Focus Bracket (→144)
		[AF Mode] (→97)
		[Pull Focus] (→179)
		[Face Recog.] (→219)
	AFL	AF Lock (→111)
		Burst (→138)
		[4K PHOTO] (→120)
		[Post Focus] (→132)
		[Self Timer] (→140)
		Remaining battery (→26)
		[Stabilizer] (→151, 152)
		Jitter alert (→151)
	PRE	[4K Pre-Burst] / [Pre-Burst Recording] (→123)
		Focus (Lights green.) (→46) / Recording state (Flashes red.) (→171)
		Focus (Under low illumination) (→95)
		Focus (Starlight AF) (→95)
		Wi-Fi connection status
		Bluetooth connection status (→259)
	GPS	Location Logging (→272)
		Histogram (→216)
3		Name* ² (→222)
		Travel elapsed days* ³ (→224)
		Age in years/months* ² (→222)
		Location* ³ (→224)
		Current date/time* ³
		Travel destination setting* ³ :  (→223)
		Exposure meter (→218)
		Focal distance display (→159)
		Step zoom (→159)
4		AF area (→103)
	+	Spot metering target (→196)
	+	[Center Marker] (→216)
		[Self Timer] (→140)
		Audio recording level display (→205)
		[Silent Mode] (→201)
	AEL	AE Lock (→111)
		[Metering Mode] (→55, 196)
		Programme Shift (→69)
	3.5	Aperture value (→46)
	BKT 3.5	Aperture Bracket (→143)
	60	Shutter speed (→46)
		Exposure compensation (→112)
	BKT 	Exposure Bracket (→142)
		Brightness (exposure) (→68, 88)
		Manual Exposure Assist (→72)
		ISO sensitivity (→114)

List of monitor/viewfinder displays

5	
	[Dial Guide] (→213)
	White Balance (→116)
	White Balance Bracket (→119)
	White Balance Fine Adjustment (→118)
	Colouring (→67)
98	Number of recordable pictures (→34)
r20	Maximum number of pictures that can be taken continuously (→138)
RXXmXXs	Available recording time*1 (→35)

6	
Touch tab (→213)	
	Touch zoom (→160)
	Touch Shutter (→54)
	Touch AF (→54)
	[Touch AE] (→55)
	[Peaking] (→215)
	Function buttons (→61)

	Colouring (→68)
	Defocus control function (→68, 88)
	Brightness (exposure) (→68, 88)
	Type of defocus ([Miniature Effect]) (→86)
	[One Point Color] (→87)
	[Sunshine] (→87)
	Picture effect (Filter) adjustment display (→84, 194)
	Picture effects ON or OFF (→194)
	Picture effects (Filter) (→194)
MINI	
F	Aperture value (→89)
SS	Shutter speed (→89)
ISO	ISO sensitivity (→89)
	Sound Rec Level Adj. (→89)

*1 [h], [m] and [s] indicate "hour", "minute" and "second".

*2 This is displayed for about 5 seconds when the camera is turned on if the [Profile Setup] setting is set.

*3 This is displayed for about 5 seconds when the camera is turned on, after setting the clock and after switching from Playback Mode to Recording mode.



■ On-monitor recording information

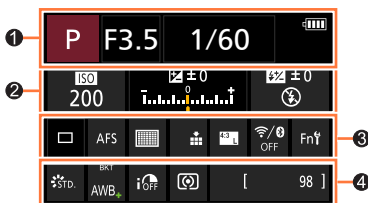

1		Recording mode (→47)
	F3.5	Aperture value (→46)
	1/60	Shutter speed (→46)
		Remaining battery (→26)

2	ISO 200	ISO sensitivity (→114)
		Exposure compensation (→112)
		Exposure Bracket (→142)
		Brightness (exposure) (→68, 88)
		Manual Exposure Assist (→72)
		[Flash] (→163, 164, 166, 169)

3		Single (→137)
		Burst (→138)
		[4K PHOTO] (→120)
		[Post Focus] (→132)
		[Self Timer] (→140)
	AFS AFF AFC MF	Focus Mode (→96, 108)

	[AF Mode] (→97)
	[Quality] (→190)
	[Aspect Ratio] (→189)/ [Picture Size] (→190)
	Wi-Fi/Bluetooth (→253)
	Function button setting (→60)

4		[Photo Style] (→192)
	AWB AWBc	White Balance (→116)
	BKT AWB+	White Balance Bracket (→119) White Balance Fine Adjustment (→118)
		[i.Dynamic] (→198)
		[Metering Mode] (→55, 196)
	98	Number of recordable pictures (→34)
	r20	Maximum number of pictures that can be taken continuously (→138)
	RXXmXXs	Available recording time* (→35)

* [h], [m] and [s] indicate "hour", "minute" and "second".

In playback

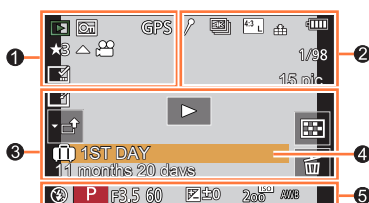

1











	Playback Mode (→237)
	Protected picture (→238)
GPS	With location information (→272)
	[Rating] (→238)
	Cable disconnect prohibit icon (→310)
	Motion picture playback (→181)
	Panorama picture playback (→78)
	Continuous playback of picture group (→185)
	Save pictures from the 4K burst file (→124)
	Save a picture from pictures recorded using [Post Focus] (→134)
	Group pictures recorded using Focus Bracket (→185)
	Text stamped display (→246)
XXhXXmXXs	Elapsed playback time*1

2

	Icon indicating the presence of a marker (→125, 126)
	4K Photo (4K burst file) (→120)
	[Post Focus] (→132)
	[Focus Stacking] (→135)
	[Aspect Ratio] (→189)/ [Picture Size] (→190)
	[Rec Format]/[Rec Quality] (→173)
	[Snap Movie] (→177)
	[Quality] (→190)
	Remaining battery (→26)
1/98	Picture number/Total pictures
	Wi-Fi connection status
15 pic.	Number of group pictures
XXhXXmXXs	Motion picture recording time*1 (→181)
	[Loop Recording(4K PHOTO)] (→123)

List of monitor/viewfinder displays

③

	Clear Retouch completed icon (→245)
	Acquiring information icon
	Playback (Motion Pictures) (→181)
 1ST DAY	Travel elapsed days (→224)
	Upload (Wi-Fi) (→286)
	Picture Group Display (→186)
	Submenu icon (→286)
	[Silent Mode] (→201)
	Multi Playback (→183)
	Delete (→187)

④

Name*2 (→220, 222)
Location*2 (→224)
Title*2 (→239)
Age in years/months (→220, 222)

⑤

Recording information

*1 [h], [m] and [s] indicate “hour”, “minute” and “second”.

*2 It is displayed in order of [Title], [Location], [Name] ([Baby1]/[Baby2], [Pet]), [Name] ([Face Recog.]).



List of monitor/viewfinder displays

Detailed information display

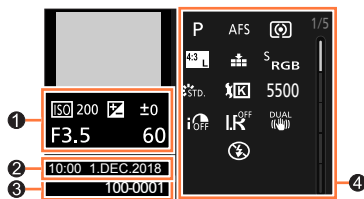

Histogram display

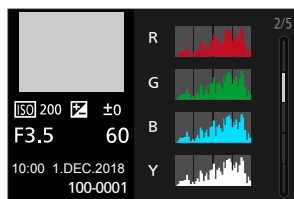
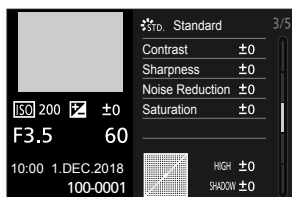
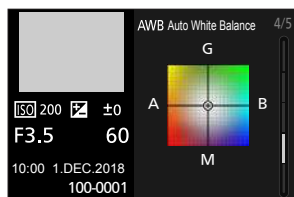

Photo style, Highlight shadow display



White balance display



Lens information display



①

Recording information (Basic)

②

Recording date/time
World time (→223)

③

100-0001 Folder/File number (→308)

④

Recording information (Advanced)

5500 White Balance (colour
temperature) (→116)

i.OFF [i.Dynamic] (→198)

HDR ON [HDR] (→203)/[iHDR] (→67)

i.R OFF [i.Resolution] (→198)



Message displays

The following explains the meaning of major messages displayed on the screen, and how to respond to them.

■ Memory cards

[Memory Card Error] / [Format this card?]

- Save needed data on a computer or other device, and then use [Format] on the camera. (→34)
- Try with a different card.

[Read Error] / [Write Error] / [Please check the card]

- Check whether card has been inserted correctly (→32).
- Turn off the camera and remove the card. Reinsert the card and turn the camera on again.
- Try with a different card.

[Recording was cancelled due to the limitation of the writing speed of the card]

- The speed class of a required card varies depending on [Rec Format] and [Rec Quality] of a motion picture. 4K photo recording requires a card that meets a particular speed class rating. Use a card that meets the rating. Be sure to use a card of the recommended speed class (→33).
- If recording stops even when using a card of the recommended speed class (→33), the data writing speed has dropped. If this happens, we recommend backing up the data on the memory card and formatting it (→34). Depending on the type of the card, recording may stop in the middle.

[Memory Card Error] / [This memory card cannot be used]

- Use a compatible card. (→33)

■ Battery

[This battery cannot be used]

- Use a genuine Panasonic battery. Consult the dealer or your nearest Service Centre if display still remains.
- Wipe any dirt away from the battery terminal.

■ Lens

[The lens is not attached properly. Do not push lens release button while lens is attached.]

- Detach the lens once, and then attach it again without pressing the lens release button. (→36)
- Turn this unit on again, and if it is still displaying, contact the dealer.

[Lens attachment failed. Please make sure the lens is attached correctly.]

- Detach the lens from the camera body and gently wipe the contacts on the lens and the camera body using a dry cotton swab.
Attach the lens, turn this unit on again, and if it is still displaying, contact the dealer.



■ Wi-Fi function

[Failed to connect wireless access point] / [Connection failed] / [No destination found]

- The wireless access point information set on this unit is wrong. Check the authentication type, encryption type, and encryption key. (→292)
- Radio waves from other devices may block the connection to a wireless access point. Check other devices that are connected to the wireless access point and devices that use the 2.4 GHz band.

[Connection failed. Please retry in a few minutes.] / [Network disconnected. Transfer stopped.]

- Radio waves from the wireless access point are getting weak. Perform the connection closer to the wireless access point.
- Depending on the wireless access point, connection may be automatically disconnected after specific time has passed. Reconnect the connection again.

[Connection failed]

- Change the access point to connect to in the smartphone Wi-Fi settings to this camera.

■ Others

[Some pictures cannot be deleted] / [This picture cannot be deleted]

- Non-DCF pictures (→180) cannot be deleted. Save needed data on a computer or other device, and then use [Format] on the camera. (→34)

[Cannot be set on this picture]

- [Title Edit], [Text Stamp], and other functions cannot be used for pictures that are not compliant with the DCF standard (→180).

[A folder cannot be created]

- A folder cannot be created because available folder numbers have been already assigned. Save all necessary pictures to your computer or other devices and format the card (→34). After you format the card, execute [No.Reset] in the [Setup] menu to reset the folder number to 100. (→232)

[Please turn camera off and then on again] / [System Error]

- Turn the camera on again. (Consult the dealer or your nearest Service Centre if display still remains.)



Q&A Troubleshooting

- ① Try checking these items (→324 - 332) first.

If the problem persists,

- ② Performing [Reset] in the [Setup] menu may resolve the issue (→232).
 ③ Also, see the Panasonic support site for the latest support information.
<http://panasonic.jp/support/global/cs/dsc/>
 (This site is available in English only.)

When I shake the camera, I hear a rattling sound from the camera.

- The sound is caused by the In-Body Image Stabiliser. This is not a malfunction.

■ Battery, power

The charging lamp blinks.

- Charging is being performed in a place with extremely high or low temperature.
 → Reconnect the USB connection cable (supplied) and retry charging in a place where ambient temperature is 10 °C to 30 °C (50 °F to 86 °F) (temperature conditions also apply to the battery itself).
- Charging is not possible if the power supply capacity of the computer is low.

Camera does not work even if the camera is turned on. Camera switches off as soon as the camera is turned on.

- Battery needs recharging.
 → Charge the battery. (→22)

This unit is turned off automatically.

- [Economy] is activated. (→226)

The battery runs down quickly.

- [4K PHOTO] is set to [4K Pre-Burst] or [Pre-Burst Recording].
 → When [4K Pre-Burst] or [Pre-Burst Recording] has been selected, the battery drains faster.
 Select [4K Pre-Burst] or [Pre-Burst Recording] only when recording.
- The Wi-Fi connection has been on for a long time.
 → The battery is used up faster with a Wi-Fi connection. Turn off the camera as often as possible using [Economy] (→226) or other methods.



■ Recording

Striping or flicker may appear under lighting such as fluorescent lighting and LED lighting fixture.

- This is characteristic of MOS sensors which serve as the camera's pickup sensors. This is not a malfunction.
- If you are taking still pictures using the electronic shutter, the striping may be reduced by setting a slower shutter speed. (→71)
- When noticeable flicker or striping is seen under lighting such as a fluorescent or LED lighting fixture in the motion picture recording mode, you can reduce the flicker or striping by setting up [Flkr Decrease] (→205) and fixing the shutter speed. It is possible to select a shutter speed from [1/50], [1/60], [1/100], or [1/120]. You can set the shutter speed manually in the Creative Video Mode. (→89)



Cannot record pictures. The shutter will not operate immediately when the shutter button is pressed.

- When [Focus/Release Priority] is set to [FOCUS], the camera will not record until proper focusing is achieved. (→210)

Recorded pictures look white.

- Lens or image sensor is dirty (fingerprints, etc.).
→ If the lens is dirty turn the camera off and then gently wipe the lens surface with a soft, dry cloth.
- When the image sensor gets dirty (→334).

Recorded pictures are too bright/too dark.

- AE Lock (→111) is set inappropriately.

Some pictures are taken when I press the shutter button just once.

- Drive Mode is set to other than [Single]. (→137)
- Bracket recording is set. (→141)

Focus not aligned correctly.

- Subject outside of focus range.
- [Focus/Release Priority] is set to [RELEASE]. (→210)
- [Shutter AF] is set to [OFF]. (→208)
- AF Lock (→111) is set inappropriately.
- If there are fingerprints or dirt on the lens, the focus may be set to the lens and not the subject.

Recorded pictures are blurred. The stabiliser function ineffective.

- Shutter speed is slower in dark locations and the stabiliser function is less effective.
→ Use a tripod and the self-timer (→140) when using a slower shutter speed.



Recorded pictures appear coarse, or there is interference.

- We recommend trying the following methods.
 - Lower ISO sensitivity (→114).
 - Either adjust [Noise Reduction] of [Photo Style] to a higher setting or set each item other than [Noise Reduction] to a lower setting. (→193)
 - Set [Long Shtr NR] to [ON]. (→199)

Subject appears skewed in pictures.

- If you take a picture of a moving subject in the electronic shutter mode, motion picture recording mode, or 4K photo recording mode, the subject in the picture may be skewed in some cases. This is characteristic of MOS sensors which serve as the camera's pickup sensors. This is not a malfunction.

Stripes appear in high ISO sensitivity.

- Stripes may appear in high ISO sensitivity or depending on the lens you use.
 - Decrease the ISO sensitivity. (→114)

Brightness or colouring of recorded picture different from real life.

- When recording under fluorescent or LED lighting fixture etc., increasing the shutter speed may introduce slight changes to brightness and colour. These are a result of the characteristics of the light source and do not indicate a malfunction.
- When recording subjects in extremely bright locations or recording under fluorescent lighting, LED lighting fixture, mercury lamp, sodium lighting etc., the colours and screen brightness may change or horizontal striping may appear on the screen.

Bright spot not in subject is recorded.

- There may be defective pixels in the image sensor.
 - Perform [Pixel Refresh] (→233).

You cannot compensate the exposure.

- Press the rear dial to switch to Exposure Compensation operation when [Exposure Dial] is set to [OFF] in [Dial Set.] in the [Custom] ([Operation]) menu. (→112)

4K photo recording stops before finishing.

- When the ambient temperature is high or recording of the 4K Photo function is performed continuously, the camera may display [] and stop the recording. Wait until the camera cools down.



■ Motion Picture

Cannot record motion pictures.

- When a large capacity card is used, you may not be able to take a picture for a while after you turn on the camera.

Motion picture recording stops midway.

- When the ambient temperature is high or motion picture is recorded continuously, the camera may display [] and stop the recording. Wait until the camera cools down.
- The speed class of a required card varies depending on [Rec Format] and [Rec Quality] of a motion picture. Be sure to use a card of the recommended speed class ([→33](#)).

Sometimes focus adjustment with Auto Focus mode is difficult while recording 4K motion pictures.

- This may occur when taking a picture by reducing the Auto Focus speed in order to adjust the focus at high precision. This is not a malfunction.

A noise, such as a clicking or buzzing noise, is recorded on a motion picture. Audio is recorded at low volumes.

- When recording in a quiet environment, the sound of aperture, focus and other actions may be recorded in motion pictures depending on the lens used. This is not a malfunction. The focus operation during recording of motion pictures can be set to [OFF] in [Continuous AF] ([→175](#)).
- If you block the microphone with your fingers while motion pictures are being recorded, the audio may be recorded at a low volume or may not be recorded at all. In this case, the camera may pick up the lens operating sounds more easily.

Operating sounds are recorded in a motion picture.

- We recommend recording motion pictures in Creative Video Mode if you are concerned about operating noise. ([→89](#))

■ Lens

When the lens is attached to another digital camera, manual focus operation cannot be performed.

- You can use Manual Focus with the interchangeable lens (H-FS12032) only if your model is compatible with the lens.

Refer to the support website below for details:

<http://panasonic.jp/support/global/cs/dsc/>

(This Site is English only.)



■ Flash

No flash emitted.

- The flash becomes unavailable in the following cases.
 - The flash is closed.
 - Flash set to [⚡] (Forced Flash Off). (→161, 165)
- Set [Shutter Type] to [AUTO] or [MSHTR]. (→201)
- Set [Silent Mode] to [OFF]. (→201)

■ Monitor/viewfinder

The monitor/viewfinder is turned off although the camera is turned on.

- If no operations are performed during the set time period [Auto LVF/Monitor Off] (→226) is activated, and the monitor/viewfinder turns off.
- When a hand or an object is close to the eye sensor, the monitor display mode could be switched to viewfinder display mode. (→45)

It may flicker for an instant or the brightness of the screen may change significantly for an instant.

- This occurs due to the aperture of the lens changing when the shutter button is pressed halfway, or when the brightness of the subject changes. This is not a malfunction.

Cannot switch between the monitor and viewfinder when pressing [LVF] button.

- When it is connected to a computer or printer, the camera can display pictures on the monitor only.

The colour tone of the viewfinder differs from the actual tone.

- Being a characteristic of the viewfinder of this unit, this phenomenon is not a problem. Recorded images are not affected.

■ Playback

Cannot view pictures. There are no recorded pictures.

- A card is not inserted in the camera.
- Has the file name of the picture been changed on a computer? If so, it cannot be played back on the camera.
 - It is recommended to use the "PHOTOfunSTUDIO" software (→305) to write pictures from PC to card.
- Set [Playback Mode] to [Normal Play]. (→237)

Red areas in pictures appear blackened.

- When the digital red-eye correction ([⚡], [⚡]) is operating, red areas may be blackened.
 - We recommend closing the built-in flash, setting the flash mode to [⚡], or setting [Red-Eye Removal] to [OFF] before recording. (→198)



■ Wi-Fi function

A Wi-Fi connection cannot be established. Radio waves get disconnected. Wireless access point is not displayed.

General tips for using a Wi-Fi connection

- Use within the communication range of the wireless LAN network.
- Is any device, such as microwave oven, cordless phone, etc., that uses 2.4 GHz frequency operated nearby?
 - Radio waves may get interrupted when used simultaneously. Use them sufficiently away from the device.
- When the battery indicator is flashing red, the connection with other equipment may not start or the connection may be disrupted. (A message such as [Communication error] is displayed.)
- When this unit is placed on a metal table or shelf, the connection may not be established easily. Use the camera away from metal surfaces.

About a wireless access point

- Check if the wireless access point to connect is in operating state.
- Check the radio wave condition of the wireless access point.
 - Perform the connection closer to the wireless access point.
 - Move the location or change the angle of the wireless access point.
- It may not display even if the radio waves exist depending on the setting of the wireless access point.
 - Turn off the wireless access point and then turn it back on.
- Is the network SSID of the wireless access point set not to broadcast?
 - It may not be detected when it is set not to broadcast. Enter and set the network SSID. (→292)
Alternatively, set the network SSID of the wireless access point to broadcast.

This unit is not displayed in the Wi-Fi setting screen of the smartphone.

- Try switching the ON/OFF of the Wi-Fi function in the Wi-Fi settings of the smartphone.

I am having a problem connecting to my Windows 8 PC. The user name and password are not recognised.

- Depending on the OS version, on Windows 8, for example, there are two types of user account (local account/Microsoft account).
 - Be sure to set the local account and use the user name and password for the local account.



The Wi-Fi connection is not recognising my PC.**The camera cannot be connected to Mac computer/Windows PC via Wi-Fi connection.**

- By default, the Wi-Fi connection uses the default workgroup name of "WORKGROUP". If the name of the workgroup has been changed, it will not be recognised.
→ Select [PC Connection] in the [Wi-Fi Setup] to change the workgroup name to match that of your PC. (→297)
- Please confirm login name and password are correctly typed.
- When the system time of a computer connected to a camera differs severely from that of the camera, the camera cannot be connected to the computer in some OSs.
→ Please confirm clock set and world time of the camera matches with time, date and time zone in the computer. When both settings do not match severely, please match them.

Images cannot be transmitted to the WEB service.

- Confirm that the login information (login ID/user name/email address/password) is correct.

It takes time to transmit an image to the WEB service.**Transmission of the image fails midway. There is an image that could not be transmitted.**

- Is the size of the image too large?
→ Transmit after dividing the motion picture with [Video Divide] (→249).
→ Reduce the image size at [Size] (→278), and then send.
- It may take longer time to transmit when distance to the wireless access point is far.
→ Transmit closer to the wireless access point.
- File format of the picture that can be sent differs depending on the destination. (→276)

I have forgotten the password for the Wi-Fi.

- Execute the [Reset Network Settings] in the [Setup] menu. (→232)
However, the information you have set on the [Wi-Fi Setup] or [Bluetooth] will be reset.



■ TV, computer, printer

No image appears on TV. Image blurred or not coloured.

- Not connected correctly (→300).
- The television has not been switched to auxiliary input.

VIERA Link (HDMI) is not working.

- Is the camera's [VIERA Link] setting set to [ON]? (→229)
→ Check the VIERA Link (HDMI) settings on the device you are connecting to.
→ Turn the camera off and on again.

Cannot communicate with the computer.

- Set [USB Mode] to [PC(Storage)] (→228, 307).
- Turn the camera off and then on again.

Computer does not recognise card. (When using an SDXC Memory Card)

- Check whether your computer is compatible with SDXC Memory Cards.
- A message prompting you to format the card may appear when you connect it. Do not format the card.
- If the [Access] indicator on the screen does not go off, turn the camera off before disconnecting the USB connection cable (supplied).

Cannot print when connecting to printer.

- Printer not compatible with PictBridge.
- Set [USB Mode] to [PictBridge(PTP)] (→228, 310).

The edges of pictures are cut off when printing.

- Release any trimming or edgeless printing settings on printer before printing.
- The aspect ratio of pictures is different from that of paper used for printing.
→ If printing in shop, check if 16:9 sizes can be printed.

■ Others

When I shake the camera, I hear a rattling sound from the attached lens.

- Depending on the lens you attach, it may move inside and create a sound. This is not a malfunction.

The camera makes a noise when this unit is turned on.

- This is the noise of the Dust Reduction Function working (→334); it is not a malfunction.

The lens makes a clicking noise.

- When the camera is turned on or off, the lens is moved, or an aperture operation is performed, such a noise may be heard. This is not a malfunction.
- When the brightness changes after a zooming operation or moving the camera, the lens may make a noise while adjusting the aperture. This is not a malfunction.

Red lamp illuminated when pressing shutter button halfway in dark locations.

- [AF Assist Lamp] is set to [ON] (→209).

Camera is hot.

- Camera may become a little warm during use, but this does not affect performance or quality.

Clock is incorrect.

- If you do not use the camera for a long time, the clock may be reset.
→ Reset the clock (→41).



Usage cautions and notes

When in use

- **Keep this unit as far away as possible from electromagnetic equipment (such as microwave ovens, TVs, video games etc.).**
 - If you use this unit on top of or near a TV, the pictures and/or sound on this unit may be disrupted by electromagnetic wave radiation.
 - Do not use this unit near cell phones because doing so may result in noise adversely affecting the pictures and/or sound.
 - Recorded data may be damaged, or pictures may be distorted, by strong magnetic fields created by speakers or large motors.
 - Electromagnetic wave radiation may adversely affect this unit, disturbing the pictures and/or sound.
 - If this unit is adversely affected by electromagnetic equipment and stops functioning properly, turn this unit off and remove the battery or disconnect AC adaptor. Then reinsert the battery or reconnect AC adaptor and turn this unit on.
- **Do not use this unit near radio transmitters or high-voltage lines.**
 - If you record near radio transmitters or high-voltage lines, the recorded pictures and/or sound may be adversely affected.
- Do not extend the supplied cord or cable.
- Do not allow camera to come into contact with pesticides or volatile substances (can cause surface damage or coating to peel).
- Do not keep objects such as credit cards that may be influenced magnetically close to this unit. The data on these objects may become corrupted and unusable.
- Never leave the camera and the battery in a car or on a car hood in the summer. Doing so may cause leakage of the battery electrolyte, overheating, fire or a battery explosion due to the high temperature.



Caring for your camera

To clean your camera, remove the battery, the DC coupler (optional) or a card, or disconnect the power plug from the outlet, and wipe with a soft, dry cloth.

- Use a damp cloth to remove stubborn stains, before wiping with a dry cloth.
- Do not use benzine, thinners, alcohol, or kitchen detergent, as these may damage the outer casing and finish of the camera.
- If using a chemically-treated cloth, read the supplied instructions carefully.

■ About dirt on the image sensor

This camera features an interchangeable lens system so dirt may get inside the camera body when changing lenses. Depending on the recording conditions, dirt on the image sensor may appear on the recorded picture.

To prevent debris or dust adhering to internal parts of the body, avoid changing the lens in a dusty environment and always fit the body cap or a lens when storing the camera. Remove any dirt on the body cap before attaching it.

Dust reduction function

This unit has a dust reduction function that will blow off the debris and dust that have affixed to the front of the imaging device.

This function will function automatically when the camera is turned on, but if you see dust, perform the [Sensor Cleaning] in the [Setup] menu.

Removing dirt on the image sensor

The image sensor is very precise and delicate, so be sure to observe the following when you do have to clean it yourself.

- Blow off the dust on the surface of the image sensor with a commercially available blower brush. Be careful not to blow too strongly.
- Do not put the blower brush further inside than the lens mount.
- Do not let the blower brush touch the image sensor as the image sensor may get scratched.
- Do not use any objects except a blower brush to clean the image sensor.
- If you cannot remove the dirt or dust with the blower, consult the dealer or Panasonic.

■ For care of the viewfinder/Eye cup

- As the eye cup cannot be removed, blow away the dust on the viewfinder surface with a blower (commercially available), gently wipe it with a dry and soft cloth, and be careful not to remove it.
- If you wipe the eye cup too hard and it is removed, consult the dealer or Panasonic.



When not using for a while

- Turn off the camera before removing battery and card.
 - Ensure that battery is removed to prevent damage through over-discharge.
 - Clock settings will be saved for approx. 3 months even after the battery is removed, provided a fully charged battery was installed in the camera for 24 hours beforehand.
- Do not leave in contact with rubber or plastic bags.
- Store together with a drying agent (silica gel) if leaving in drawer, etc. Store batteries in cool (15 °C to 25 °C (59 °F to 77 °F)) places with low humidity (40%RH to 60%RH) and no major temperature changes.
- Charge battery once per year and use completely before storing again.
- Check all the parts before taking pictures when you have not used the camera for a long period of time.

Monitor/viewfinder

- Do not press hard on the monitor. This may cause uneven display and damage the monitor.
- In cold climates or other situations when the camera becomes cold, the monitor or the viewfinder may appear slightly darker than normal immediately after the camera is turned on. Normal brightness will return once the internal components have warmed up.

The monitor and viewfinder are made with extremely high precision technology. However there may be some dark or bright spots (red, blue or green) on the screen. This is not a malfunction. The monitor and viewfinder screens are controlled with extremely high precision, but some pixels may be inactive. The spots will not be recorded on pictures on a card.



Lens

- Do not press the lens with excessive force.
- Do not leave the camera with the lens facing the sun as rays of light from the sun may cause it to malfunction. Also, be careful when placing the camera outside or near a window.
- When there is dirt (water, oil, and fingerprints, etc.) on the surface of the lens, the picture may be affected. Lightly wipe the surface of the lens with a soft, dry cloth before and after taking pictures.
- Do not place the lens mount facing downwards. Do not allow the lens mount contacts (A) to become dirty.
- To improve the dust- and splash-proof performance, the mount of the interchangeable lens (H-FS12060) is embedded with the lens mount rubber. If you change the lens repeatedly, friction with the lens mount rubber may leave scratches on the camera's mount. However, those scratches do not affect the performance of this unit. For the replacement of the lens mount rubber, contact Panasonic.

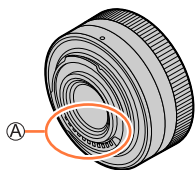

Battery

The battery is a rechargeable lithium ion battery.

This battery is easily affected by temperature and humidity, and is affected more when the temperature is high or low.

- Remove battery from camera after use.
 - Keep the battery in a plastic bag, making sure that it is kept away from metallic objects (such as clips) when carrying or storing it.
- The time required for charging varies depending on conditions of battery usage. Charging takes longer at high or low temperatures and when the battery has not been used in some time.
- Battery will be warm during charging and for some time thereafter.
- Battery will run out if not used for long periods of time, even after being charged.
- Do not leave any metal items (such as clips) near the contact areas of the power plug. Otherwise, a fire and/or electric shocks may be caused by short-circuiting or the resulting heat generated.
- Frequently charging up battery is not recommended.
(Frequently charging battery reduces maximum usage time and can cause battery to expand.)
- If available battery power is significantly reduced, battery is reaching end of lifespan. Please purchase a new battery.
- When charging:
 - Wipe dirt from the battery terminal with a dry cloth.
 - Keep at least 1 m (3.3 feet) away from AM radio (may cause radio interference).
- Do not use a damaged or dented battery (especially connectors), e.g. by dropping (can cause faults).

AC adaptor (supplied)

- Keep at least 1 m (3.3 feet) away from AM radio (may cause radio interference).
- The AC adaptor (supplied) may generate whirring sounds when it is being used. This is not a malfunction.
- After use, be sure to disconnect the power supply device from the electrical outlet. (A very small amount of current is consumed if it is left connected.)



Memory cards

- To prevent damage to cards and data
 - Avoid high temperatures, direct sunlight, electromagnetic waves, and static electricity.
 - Do not bend, drop, or expose to strong impacts.
 - Put the card in the card case or the storage bag after use and when storing or carrying the card.
 - Do not touch terminals on reverse of card or allow them to become dirty or wet.
- Recorded data may be damaged or lost if the camera breaks down due to inappropriate handling. Panasonic will not be liable for any damage caused due to loss of recorded data.
- When disposing of/transferring memory cards
 - If using the “format” or “delete” functions on your camera or computer, this only changes the file management information, and does not completely delete the data from within the memory card. When disposing of or transferring your memory cards, we recommend physically destroying them, or using commercially available computer data erasing software to completely delete the data from the card. Data within memory cards should be managed responsibly.

When using a tripod or unipod

- Do not apply excessive force or tighten screws when they are crooked. (This may damage the camera, screw hole, or label.)
- Ensure that the tripod is stable. (Refer to the tripod instructions.)
- You may not be able to remove the card or the battery when using a tripod or unipod.
- When using this unit with a large-diameter lens, the lens may come into contact with the pedestal depending on the tripod/unipod. Tightening the screw with the lens and pedestal in contact with each other may damage this unit or the lens. Therefore it is recommended to attach the tripod adaptor (DMW-TA1: optional) before mounting on the tripod/unipod.

About the shoulder strap

- If you attach a heavy interchangeable lens (more than about 1 kg/35.3 oz) to the camera body, do not carry the camera by the shoulder strap. Hold the camera and the lens when carrying them.

Personal Information

To protect personal information, we recommend that you set a Wi-Fi password or a Wi-Fi function lock. (→297)

If names or birthdays are set in [Profile Setup] or in the [Face Recog.] function, keep in mind that the camera and recorded pictures will contain personal information.

Be sure to pay special attention to the privacy, likeness rights, etc. of a subject and take your own responsibility when you use the [Silent Mode], or use functions such as writing the location information and changing the shutter noise, etc.

● Disclaimer

- Data containing personal information can be altered or lost due to malfunction, static electricity, accidents, breakdowns, repairs, or other operations.

Panasonic will not be liable for any damage that occurs, direct or indirect, as a result of the alteration or loss of data containing personal information.

● When ordering repairs or transferring/disposing of the camera

- After you make a note of the personal information, perform [Reset Network Settings]/[Delete account] to delete data containing personal information such as wireless LAN connection settings that you registered or set in this unit. (→232, 290)
- To protect your personal information, please reset the settings. (→232)
- Remove the memory card from the camera.
- When ordering repairs, settings may be returned to the initial purchase state.
- If the above operations cannot be performed because of a camera malfunction, consult with the dealer or nearest Service Centre.

● When transferring or disposing of your memory card, see “When disposing of/transferring memory cards” in the previous section. (→338)

● Uploading pictures to WEB services

- Pictures may contain personal information that can be used to identify the user, such as titles, recording dates and times, and location information. Before uploading the pictures to WEB services, check the pictures carefully for information that should not be disclosed.



Wi-Fi function

■ Use the camera as a wireless LAN device

When using equipment or computer systems that require more reliable security than wireless LAN devices, ensure that the appropriate measures are taken for safety designs and defects for the systems used. Panasonic will not take any responsibility for any damage that arises when using the camera for any purpose other than as a wireless LAN device.

■ Use of the Wi-Fi function of this camera is presumed to be in countries where this camera is sold

There is the risk that the camera violates the radio wave regulations if used in countries other than those where this camera is sold, and Panasonic takes no responsibility for any violations.

■ There is the risk that data sent and received via radio waves may be intercepted

Please note that there is the risk that data sent and received via radio waves may be intercepted by a third party. We strongly recommend that you enable encryption in the settings of your wireless access point to ensure information security.

■ Do not use the camera in areas with magnetic fields, static electricity or interference

- Do not use the camera in areas with magnetic fields, static electricity or interference, such as near microwave ovens. Radio waves may not reach the camera.
- Using the camera near devices such as microwave ovens or cordless telephones that use the 2.4 GHz radio wave band may cause a decrease in performance in both devices.

■ Do not connect to the wireless network you are not authorised to use

When the camera utilises its Wi-Fi function, wireless networks will be searched automatically. When this happens, wireless networks that you are not authorised to use (SSID*) may be displayed, however do not attempt to connect to the network as it may be considered as unauthorised access.

* SSID refers to the name that is used to identify a network over a wireless LAN connection. If the SSID matches for both devices, transmission is possible.



Usage cautions and notes

- G MICRO SYSTEM is a lens exchange type digital camera system of LUMIX based on a Micro Four Thirds System standard.
- Micro Four Thirds™ and Micro Four Thirds Logo marks are trademarks or registered trademarks of Olympus Corporation, in Japan, the United States, the European Union and other countries.
- Four Thirds™ and Four Thirds Logo marks are trademarks or registered trademarks of Olympus Corporation, in Japan, the United States, the European Union and other countries.
- SDXC Logo is a trademark of SD-3C, LLC.
- The terms HDMI and HDMI High-Definition Multimedia Interface, and the HDMI Logo are trademarks or registered trademarks of HDMI Licensing Administrator, Inc. in the United States and other countries.
- HDAVI Control™ is a trademark of Panasonic Corporation.
- “AVCHD”, “AVCHD Progressive” and the “AVCHD Progressive” logo are trademarks of Panasonic Corporation and Sony Corporation.
- Dolby, Dolby Audio, and the double-D symbol are trademarks of Dolby Laboratories.
- Adobe is a trademark or registered trademark of Adobe Systems Incorporated in the United States and/or other countries.
- Pentium is a trademark of Intel Corporation in the U.S. and/or other countries.
- Windows is either registered trademark or trademark of Microsoft Corporation in the United States and/or other countries.
- iMovie, Mac, OS X and macOS are trademarks of Apple Inc., registered in the U.S. and other countries.
- iPad, iPhone, iPod, and iPod touch are trademarks of Apple Inc., registered in the U.S. and other countries.
- App Store is a service mark of Apple Inc.
- Android and Google Play are trademarks or registered trademarks of Google Inc.
- The Bluetooth® word mark and logos are registered trademarks owned by the Bluetooth SIG, Inc. and any use of such marks by Panasonic Corporation is under license. Other trademarks and trade names are those of their respective owners.
- The Wi-Fi CERTIFIED™ Logo is a certification mark of Wi-Fi Alliance®.
- The Wi-Fi Protected Setup™ Logo is a certification mark of Wi-Fi Alliance®.
- “Wi-Fi®” is a registered trademark of Wi-Fi Alliance®.
- “Wi-Fi Protected Setup™”, “WPA™”, and “WPA2™” are trademarks of Wi-Fi Alliance®.
- DLNA, the DLNA Logo and DLNA CERTIFIED are trademarks, service marks, or certification marks of the Digital Living Network Alliance.
- QR Code is a registered trademark of DENSO WAVE INCORPORATED.
- This product uses “DynaFont” from DynaComware Corporation. DynaFont is a registered trademark of DynaComware Taiwan Inc.
- Other names, company names, and product names mentioned in these instructions are trademarks or registered trademarks of the companies concerned.





This product is licensed under the AVC Patent Portfolio License for the personal use of a consumer or other uses in which it does not receive remuneration to (i) encode video in compliance with the AVC Standard ("AVC Video") and/or (ii) decode AVC Video that was encoded by a consumer engaged in a personal activity and/or was obtained from a video provider licensed to provide AVC Video. No license is granted or shall be implied for any other use. Additional information may be obtained from MPEG LA, L.L.C.
See <http://www.mpegla.com>

