

AUS/NZ

# Panasonic®

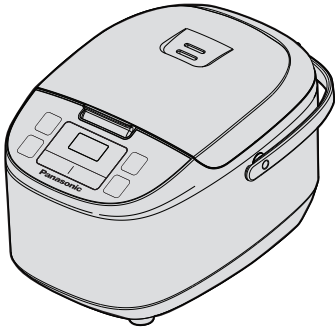

## Operating Instructions Electric Rice Cooker Household Use

Model No. : SR-ZE185 / SR-ZE105

### Table of Content

<b>Safety Precautions</b> .....	2-3	Before use
Parts identification .....	4	
• Display .....	4	
• Parts identification .....	4	
<b>Preparations</b> .....	5-6	Usage
<b>Functions</b> .....	7-11	
• White Rice, Jasmine, Multi Grain, Quick Cook, Brown Rice or Sticky Rice .....	7	
• Claypot .....	8	
• Porridge .....	9	
• Steam .....	10	
• Soup / Slow Cook .....	11	
Using the Timer .....	12	
Cleaning and maintenance .....	13	
How to use adjustable steam basket / When the display shows as follows .....	14	
<b>Troubleshooting</b> .....	15	In trouble
Specifications .....	16	
Panasonic Warranty .....	17-18	
Memo .....	19	

Thank you for purchasing the Panasonic product.

- This product is intended for household use only.
- Please read these instructions carefully and follow safety precautions when using this product.
- Before using this product **please give your special attention to “Safety Precautions” (Page 2-3).**

Reserve it for later use

# Safety Precautions

Must be followed!

In order to prevent accidents or injuries to the users, other people, and damage to property, please follow the instructions below.

■ The following charts indicate the degree of damage caused by wrong operation.

 <b>WARNING:</b> Indicates serious injury or death.	 <b>CAUTION:</b> Indicates risk of injury or property damage.
---	--

■ The symbols are classified and explained as follows.

 These symbols indicate prohibition.	 This symbol indicates requirement that must be followed.
--	--

## WARNING

■ Do not use the appliance if the power cord or power plug is damaged or the power plug is loosely connected to the power outlet.



(It may cause an electric shock or fire caused by short circuit.)

■ Do not insert any objects in the steam vent or gap.



Especially metal objects such as pins or wires. (It may cause an electric shock or malfunction.)

■ This appliance is not intended for use by persons (including children) with reduced physical, sensory or mental capabilities, or lack of experience and knowledge, unless they have been given supervision or instruction concerning use of the appliance by a person responsible for their safety. Children should be supervised to ensure that they do not play with the appliance.



(It may cause burn or injury.)

■ Clean the power plug regularly.



(A soiled power plug may cause insufficient insulation due to the moisture, and may cause a fire.)

- Unplug the power plug, and wipe with a dry cloth.

■ Do not damage the power cord or power plug.



Following actions are strictly prohibited.

Modifying, placing near heating elements, bending, twisting, pulling, putting heavy objects on top, and bundling the cord. (It may cause an electric shock or fire caused by short circuit.)

- If the supply cord is damaged, it must be replaced by a special cord or assembly available from the manufacturer or its service agent.

■ Do not immerse the appliance in water or splash it with water.



(It may cause a fire caused by short circuit or electric shock.)

- Please enquire with an authorised dealer if water gets inside the appliance.

■ Use only a power outlet rated at 10 amperes and alternating electric voltage at 240 volts.



(Plugging other devices into the same outlet may cause electric overheating, which may cause a fire.)

- Use only an extended cord rated at 10 amperes minimum.

■ Discontinue using the appliance immediately and unplug the power cord in cases of abnormal situations and breaking down.



- (It may cause smoking, a fire, or electric shock.)
- The power plug and the power cord become abnormally hot.
  - The power cord is damaged or power failure occurs when touched.
  - The main body is deformed or abnormally hot.
  - The unit gives out smoke or scorching smell.
  - There are cracks, looseness or wobbles of the appliance.
  - The cast heater is warped or the pan is deformed.

→ Please make enquiries at Panasonic authorised service centre for inspection and repair immediately.

■ Do not plug or unplug the power plug with wet hands.



(It may cause an electric shock.)

■ Do not get your face close to the steam vent or touch it with your hand. Keep the steam vent out of reach of small children.



Steam vent

(It may cause a burn.)



■ Do not modify, disassemble, or repair this appliance.



(It may cause a fire, electric shock or injury.)

- Please make enquiries at the store or the repair department of an authorised dealer.

■ Insert the instrument plug and the power plug firmly.



(Otherwise it may cause an electric shock and fire caused by the heat that may generate around the instrument plug or the power plug.)

- Do not use a broken power plug or a loose power outlet.

## CAUTION

### ■ Do not use the appliance on following places.

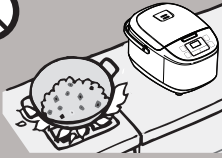

- The place where it may be splashed with water or near a heat source. (It may cause a fire caused by short circuit or electric shock.)
- An unstable surface or carpet, electric carpet, table cloths (ethylene plastic) or other object that cannot resist high temperature. (It may cause an injury, burn or fire.)
- Near a wall or furniture. (It may cause a discolouration or deformation.)

### ■ Do not touch heating elements while the appliance is in use or after cooking.



Especially the cast heater. (It may cause a burn.)

### ■ Do not expose the power plug to steam and do not let water spill on the connector of the power plug.



- Do not expose the power plug to steam when it is plugged in. (It may cause a fire caused by short circuit.) When using a cabinet with sliding table, use the appliance where the power plug cannot be exposed to steam.

### ■ Do not touch the hook button while moving the appliance.



(It may cause the outer lid to open, resulting in a burn.)

### ■ Be sure to hold the instrument plug or the power plug when unplugging.



(Otherwise it may cause an electric shock or fire caused by short circuit.)

### ■ Do not use the cord set (for instrument plug and power plug) that is not specified for use with this appliance. Also do not transfer them.



(It may cause an electric shock, leak, and fire.)

### ■ Be careful when opening the outer lid while cooking.



(It may cause a burn.)

### ■ Unplug the power plug from the power outlet when the appliance is not in use.



(Otherwise it may cause an electric shock and fire caused by short circuit due to the insulation deterioration.)

### ■ Heating element is subjected to residual heat after use. Please allow the appliance to cool down before cleaning it.



(Touching hot elements may cause a burn.)

### ■ Do not use other pans than the one specified.



(It may cause a burn and injury due to overheat or malfunction.)

## Precautions for Use

### Please put in correct amount of rice and water and select functions correctly according to the operating instructions.

(So as to avoid overflow of rice water, half-cooked rice or scorched rice.)

### Do not put ingredients to be cooked directly into the appliance in which no pan is placed. Do not cook without pan.

(So as to prevent any impurities from causing failure.)

### Avoid using the appliance under direct sunlight.

(So as to avoid colour change.)

### Before using the appliance, the anti-tarnish paper between the pan and the cast heater should be removed.

(So as to avoid poor cooking or fire.)

### Do not cover the outer lid with cloth or other objects when the appliance is in use.

(So as to avoid deformation, colour change of the outer lid or failure.)

### Do not serve out rice with any metal object.

(So as to avoid scratching the pan coating and causing peeling of the coating.)

### Please always clean the foreign matters such as rice on the pan, cast heater and temperature sensor.

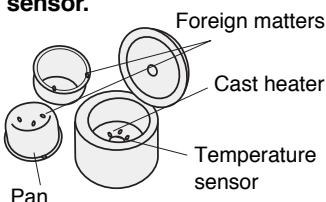

- Do not tilt or overturn the appliance.
- Before cleaning, turn off the power switch and pull out the power plug.

When there is any overflow of rice water from the steam vent, pull out the power plug immediately to disconnect the power supply. Do not resume the use until the rice water on the power plug and the instrument plug is cleaned with a dry cloth.

The appliance is for household use only. Do not use it for any commercial or industrial purposes or any purposes other than cooking.

When power failure occurs during the operation of the appliance, the cooking result may be affected.

# Parts identification

## Display

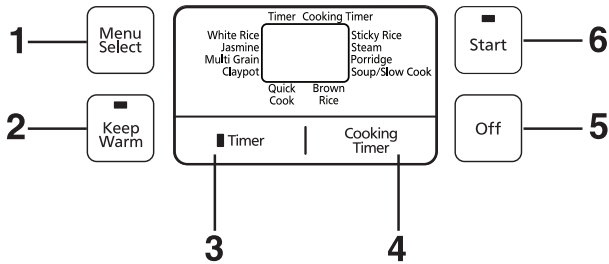

1. Press this button to select a cooking function.
2. Press this button to enter Keep Warm mode.
3. Press this button to preset timer.
4. Press this button to start setting cooking timer.
5. Press this button to cancel the operation.
6. Press this button to start cooking.

## Parts identification

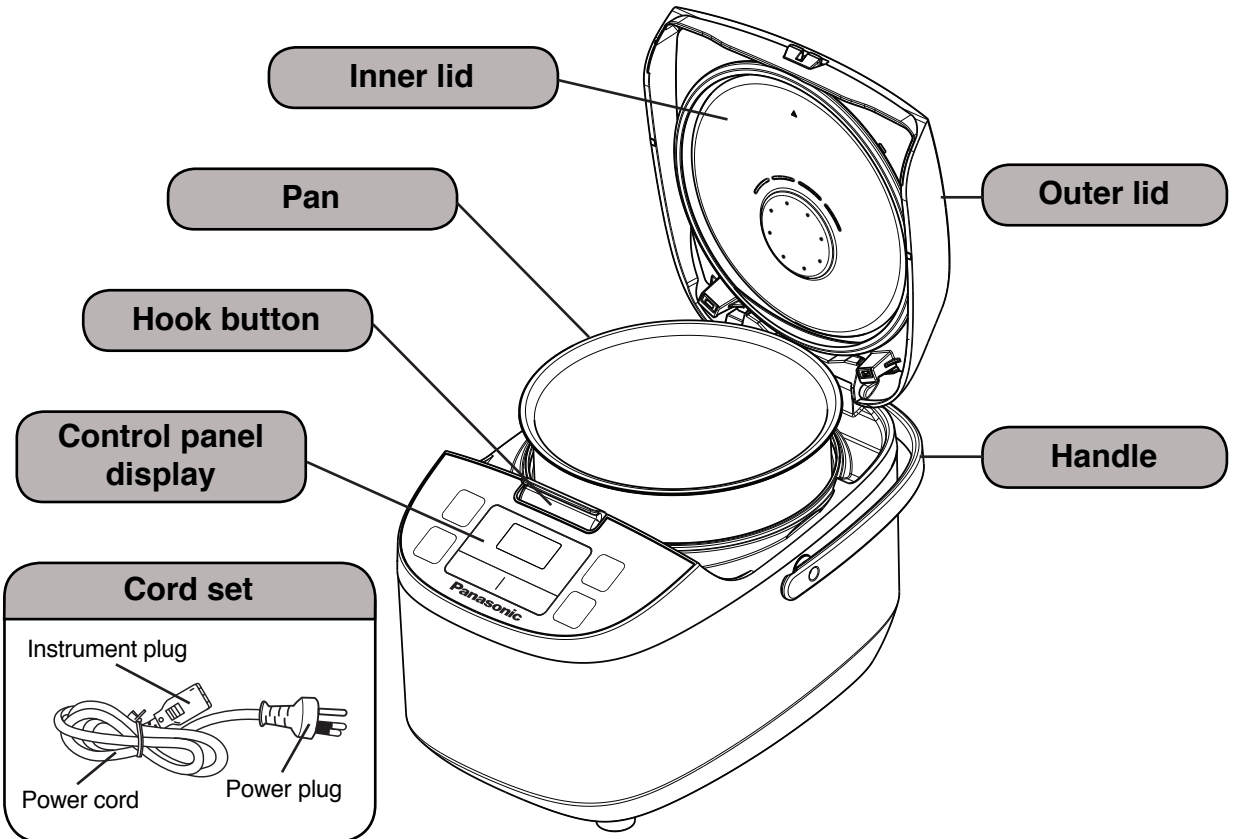

## Accessories



Measuring cup (1)  
(Approx. 180 mL)

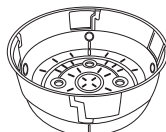

Adjustable steam  
basket (1)

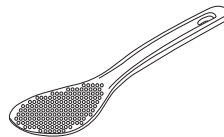

Rice scoop (1)



Porridge scoop (1)

# Preparations

## 1 Measure rice with the measuring cup provided.

- The volume of the measuring cup is about 180 mL.
- For the maximum quantity of the rice to be cooked at once, refer to specifications in P.16.

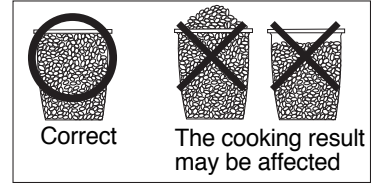

## 2 Wash the rice till the water turns relatively clear.

- ① Wash the rice quickly with plenty of water and stirring the rice lightly to wash it while changing water.
- ② Repeat it for several times (wash the rice → pour out water), till the water turns relatively clear.

### Attention

- In order to avoid scratching the non-stick coating on the pan surface, do not wash rice in the pan.
- Wash the rice thoroughly. Otherwise, rice crust may appear and the residual rice bran may affect the taste of the rice.

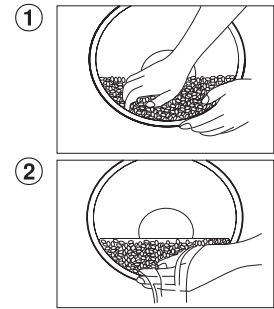

## 3 Add the washed rice or other ingredients into the pan.

- Use water line on the pan to measure water quantity as follow

Function	Water line
White Rice	White Rice
Jasmine	Jasmin Rice
Multi Grain	Multi Grain
Claypot	White Rice
Quick Cook	White Rice
Brown Rice	Brown Rice
Sticky Rice	Sticky Rice
Porridge	Porridge
Soup/Slow Cook	White Rice

<Example>  
When the rice quantity is 5 measuring cups, wash the rice and put into the pan, then add water into the pan till the water surface reaches scale "5" at water line of "White Rice".

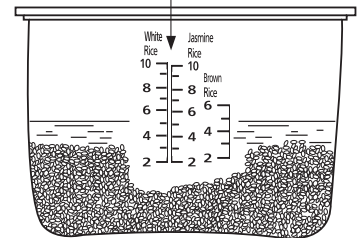

SR-ZE185

- In the Soup/Slow Cook function, the total amount of ingredients and water shall not exceed the maximum water line for "White Rice".
- Dry the outside surface of the pan. If it is wet, it may cause noise while cooking. Any foreign matters between the pan and the cast heater may damage the unit.
- Please make sure that the pan is on leveled surface.
- Please measure water by aligning water line left side and right side.
- If rice is too hard or too soft, please adjust water quantity according to your personal taste.

# Preparations

## 4 Put the pan into the body and close the outer lid.

- In order that the bottom of pan can be closely attached to the cast heater, please rotate the pan along the direction indicated by the arrow for 2 or 3 times.
- Close the outer lid until it clicks.

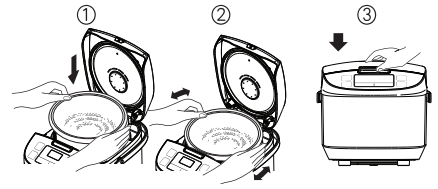

## 5 Connect the plugs.

- Please insert the instrument plug into the body first, and then connect the power plug. Make sure that both plugs are securely connected.

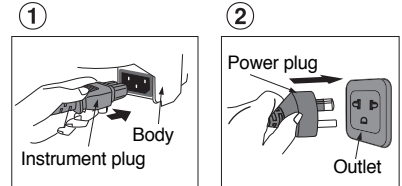

### CAUTION

- \* The right table shows the maximum allowable amount of rice that can be cooked at a same time steaming with the adjustable steam basket.

The maximum amount of rice (in measuring cups)

Height of the adjustable steam basket	Maximum amount of rice	
	SR-ZE185	SR-ZE105
Shallow	5	2
Deep	4	1

# Functions

White Rice, Jasmine, Multi Grain, Quick Cook, Brown Rice or Sticky Rice

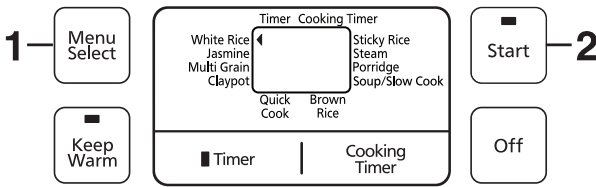

## ■ Important Information

- The amount of rice is specified in specifications. (P.16)
- In the Quick function, the rice may be harder or there may be rice crust.  
\* For brown rice, it takes about 2 hours to complete cooking.

## Operations (Cooking with the White Rice, Jasmine, Multi Grain, Quick Cook, Brown Rice or Sticky Rice function.)

**1** Press button to point to White Rice, Jasmine, Multi Grain, Quick Cook, Brown Rice or Sticky Rice function.

- The indicator blinks.

**2** Press button.

- The indicator lights up and the cooking starts.
- Before cooking is completed, the LCD display will show the remaining time in 1 minute decrement.

- If you want to preset the timer for White Rice, Jasmine, Multi Grain, Brown Rice or Sticky Rice, please refer to “Using the Timer” (on Page 12).

## The cooking is over

### Stir and loosen the rice.

- When cooking is over, the electric rice cooker beeps and automatically switches to the **Keep Warm** function (The indicator turns off and the indicator lights up automatically).

### Keep Warm

- When the cooking is over, all function will turn to **Keep Warm** function automatically (except Steam function). But some functions are not recommended to use with **Keep Warm** function. Please press button to exit **Keep Warm** function.
- You can keep the rice warm for up to 5 hours, so as not to affect the taste or cause strange smell.
- When in **Keep Warm** function, there may be some droplets at the edge of the pan.
- The rice taste may be affected if rice scoop is left in the electric rice cooker during **Keep Warm** function.



Menu	Keep warm	The result after kept warm
White Rice	○	/
Jasmine	○	
Multi Grain	○	
Quick Cook	○	
Claypot	×	Affects the taste or causes a strange smell. Flavour can be adversely affected.
Brown Rice	×	
Sticky Rice	×	It may become too thick.
Porridge	×	
Soup/Slow Cook	×	Affects the taste or causes a strange smell.

○ : Can be used, × : Not recommend for use

# Functions Claypot

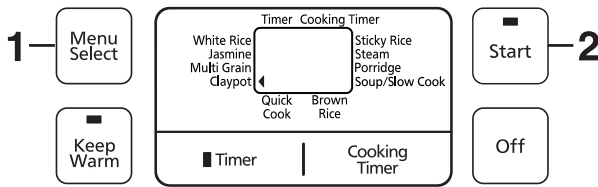

## ■ Important Information

- The amount of rice is specified in specifications. (P.16)
- Ingredients are evenly placed on the surface of the rice, it is not mixed.
- When placing ingredients, they cannot go above the maximum water line for "White Rice".
- Do not open the outer lid while cooking. (Cooking result may not be satisfactory.)

## Operations (Cooking with the Claypot function.)

**1** Press  button to point  to Claypot function.



- The  indicator blinks.

**2** Press  button.

- The  indicator lights up and the cooking starts.
- Before cooking is completed, the LCD display will show the remaining time in 1 minute decrement.

## The cooking is over

Press  button.

- When cooking is over, the electric rice cooker beeps and automatically switches to the **Keep Warm** function (The  indicator turns off and the  indicator lights up automatically). However, we do not recommend using the **Keep Warm** function as it may affect the taste. Press the  button to exit the **Keep Warm** function and unplug the power plug.



# Functions Porridge

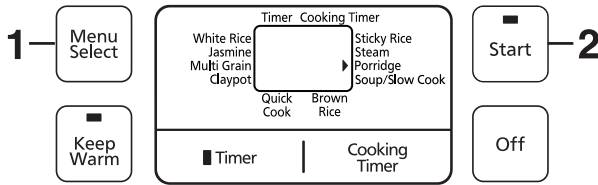

## ■ Important Information

- The amount of rice is specified in specifications. (P.16)
- If using too much water, it may cause water overflow.
- It's not recommended to use Keep Warm function since porridge may become thick.
- When the outer lid is opened during cooking, the amount of moisture condensation may be increased.

## Operations (Cooking with the Porridge function.)

**1** Press  button to point  to Porridge function.

- The  indicator blinks.



**2** Press  button.

- The  indicator lights up and the cooking starts.
- Before cooking is completed, the LCD display will show the remaining time in 1 minute decrement.

- If you want to preset the timer for Porridge, please refer to “Using the Timer” (on  Page 12).

## The cooking is over

Press  button.

- When cooking is over, the electric rice cooker beeps and automatically switches to the **Keep Warm** function (The  indicator turns off and the  indicator lights up automatically). However, we do not recommend using the **Keep Warm** function as it may become too thick. Press the  button to exit the **Keep Warm** function and unplug the power plug.

# Functions Steam

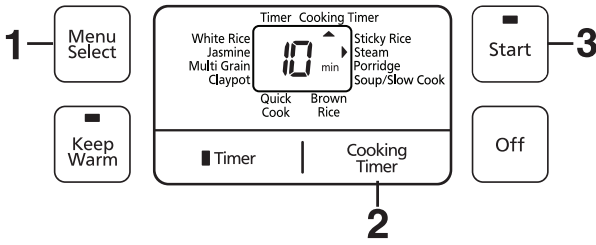

## ■ Important Information

- After boiling and complete evaporation of water, the electric rice cooker automatically switches off.
- If you want to abort steaming during cooking, press  button.
- When steaming while cooking rice at the same time, it's recommended to use Jasmine, Multi Grain or White Rice function with maximum quantity as described in P.5.
- Please do not block the hole of the inner lid with food.

## Preparations

- Add the required amount of water.
- Place the adjustable steam basket into the pan as shown.
- Place foods to be steamed into the adjustable steam basket.
- Close the outer lid.

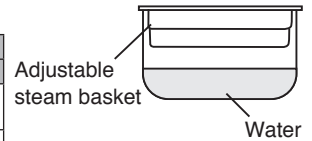

- Correspondence between the amount of water and time of steaming

Cooking time	Amount of water	
	SR-ZE185	SR-ZE105
Less than 10 minutes	1 measuring cup	1 measuring cup
10 ~ 30 minutes	2 measuring cups	2 measuring cups
30 ~ 60 minutes	4 measuring cups	3 measuring cups



## Operations (Cooking with the Steam function.)

**1** Press  button to point  to Steam function.

- The  indicator and  blink (as the default cooking time for Steam function).

**2** Press  button to set the cooking time as your desire.

- You can set the cooking time from 1 to 60 minutes (1 minute increment).
- Keeping the button pressed will make setting faster.

**3** Press  button.

- The  indicator lights up and the cooking starts.
- After water is boiled, the LCD display will show remaining time in 1 minute decrement.



## The cooking is over

- The electric rice cooker beeps and automatically switches off. (The  indicator turns off.)

# Functions Soup/Slow Cook

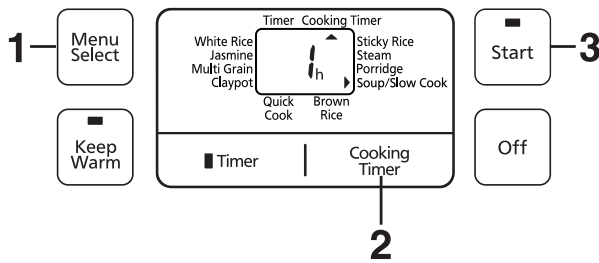





## ■ Important Information

- The maximum amount of ingredients and liquid for Soup/Slow Cook cannot exceed the maximum water line for "White Rice".



## Preparations

- Place all ingredients into the pan.
- Close the outer lid.

## Operations (Cooking with the Soup/Slow Cook function.)

- 1 Press  button to point  to Soup/Slow Cook function.
  - The  indicator and  blink (as the default cooking time for Soup/Slow Cook function).

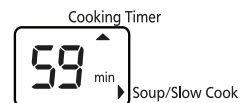

- 2 Press  button to set the cooking time as your desire.
  - You can set the cooking time from 1 to 12 hours (30 minutes increment).
  - Keeping the button pressed will make setting faster.

- 3 Press  button.
  - The  indicator lights up and the cooking starts.
  - The LCD display will show remaining time in 30 minutes decrement and reduce to 1 minute decrement when cooking time is less than 1 hour.



## The cooking is over

Press  button.

- When cooking is over, the electric rice cooker beeps and automatically switches to the **Keep Warm** function (The  indicator turns off and the  indicator lights up automatically). However, we do not recommend using the **Keep Warm** function as it may affect the taste. Press the  button to exit the **Keep Warm** function and unplug the power plug.

# Using the Timer

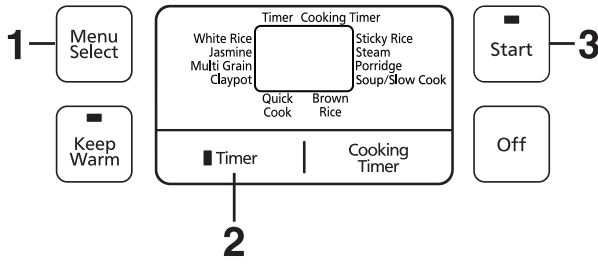

- The presetting time is a countdown timer.
- The electric rice cooker will complete cooking when the number of hours that was set has elapsed.
  - Time can be preset as 24 hours in advance.

### Example

If the timer is set for 2h, cooking will be completed at in 2 hours after button is pressed.

\* When the preset timing is less than the required timing for cooking, the electric rice cooker will start cooking as soon as button is pressed.

## Operations

**1 Press button to select function.**

- Applicable function for timer setting:

Function	Function
White Rice	Brown Rice
Jasmine	Sticky Rice
Multi Grain	Porridge

**2 Press button to set the timer as your desire.**

- The first time button is pressed, the previous timer setting will be displayed. The timer and the indicator blink.
- The timer will advance 10 minutes each time.
- Keeping the button pressed will make setting faster.

**3 Press button.**

- The indicator turns off and the indicator lights up.
- When cooking starts, the indicator turns off and the indicator lights up.
- Timer setting can't be used in the following function.

Function
Claypot
Quick Cook
Steam
Soup / Slow Cook

# Cleaning and maintenance

- Be sure to unplug and carry out these operations when the appliance is cooled down.
- Do not use objects such as benzine, thinners, cleansing powder or metal scrubbers.

## Inner lid

### ■ Remove the inner lid

Get hold of two tabs, then pull it to your direction.

### ■ Attach the inner lid

- ① Insert the protruding part into the locker on the outer lid in a tilted way.
- ② Press the tabs (both sides) inwards the outer lid sides until the click sound is heard.

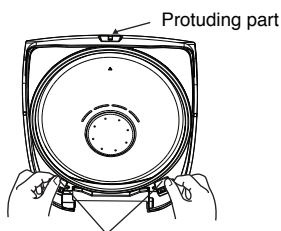

Load and Unload tabs of inner lid

- Wash with a diluted dishwashing detergent and sponge.

## Pan

Wash with a diluted dishwashing detergent and sponge and wipe off the external surface of the inner pan.

## Temperature sensor / Cast heater

If an object has become stuck to the temperature sensor / cast heater, slightly polish it off using fine sandpaper (of about # 600). Then wipe with a well-wrung cloth.

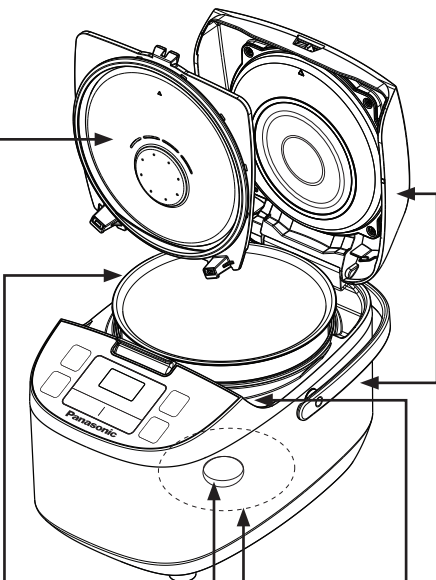

## Body / Outer lid

- Wipe with a well-wrung cloth.
- Do not use a dishwashing detergent.

## Upper frame

Wipe with well-wrung cloth.

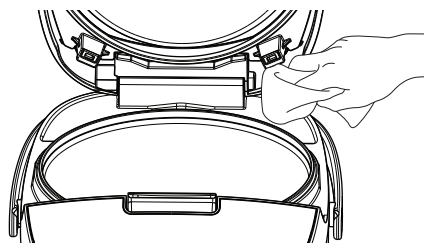

Do not pour water directly on the upper frame.

## Accessories



Measuring cup

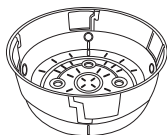

Adjustable steam basket

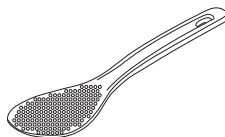

Rice scoop

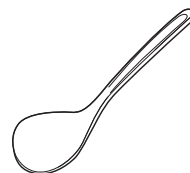

Porridge scoop

- Wash with a diluted dishwashing detergent and sponge.

# How to use adjustable steam basket / When the display shows as follows

## How to use adjustable steam basket

### ■ Height adjustment

Put your thumb on the ring on the inner wall of the rotating part, lift and slightly turn it counterclockwise, and then release your finger. The height of the adjustable steam basket will increase. To restore the previous size, hold the bottom of the rotating part with your palm, slightly turn it clockwise, and lift it up to clap.

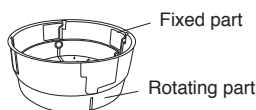

### ■ Disassembly

Firstly, restore the adjustable steam basket to the initial state (shallow), turn it over on the table, and then press down firmly on the rotating part up to clap. Fixed part and rotating part will separate.



### ■ Assembly

Direct the protrusion on the edge of the rotating part towards the trough on the inner wall of the fixed part, and then press with force on the bottom of the rotating part up to clap.

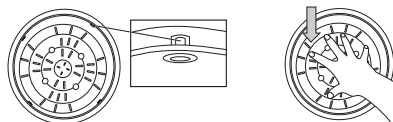

## When the display shows as follows

Display	Problems and troubleshooting
U14	Following continuous 96 hours <b>Keep Warm</b> function, the power supply will automatically cut off. Please press <input type="button" value="off"/> button first.
H01   H02 H05	Contact the authorised service centre for repair.

# Troubleshooting

Please check the following items

## Rice Cooking

Details	Cooking problems					Keep Warm problems			No power	Strange sound occurs
	Too hard	Undercooked	Too soft	Water overflow	Burnt rice at bottom of pan	Colour change	Bad smell	Too dry		
Wrong rice and water proportion.	●	●	●	●	●			●	Pull out plug and check the socket.	Sound occurs because of water that has stuck to pan.
Inadequate washing of the rice.				●	●	●	●			
Foreign matters between pan and cast heater.	●	●	●		●					
Cooking with a lot of oil.	●	●			●	●	●			
The rice has been warmed more than 5 hours.						●	●	●		
The outer lid is not securely closed.	●			●		●	●	●		
The pan is not adequately washed.					●		●			
The power cord is not connected to the socket securely.		●					●			

# Specifications

Model No.		SR-ZE185	SR-ZE105
Power Source		240 V ~ 50 Hz	
Power Consumption	In the Cooking function	750 W	
	In the Keep Warm function	66.6 W	54.5 W
Capacity	White Rice	2 - 10 cups	1 - 5.5 cups
	Jasmine	2 - 10 cups	1 - 5.5 cups
	Multi Grain	2 - 8 cups	1 - 4 cups
	Claypot	2 - 4 cups	1 - 2 cups
	Quick Cook	2 - 10 cups	1 - 5.5 cups
	Brown Rice	2 - 6 cups	1 - 3 cups
	Sticky Rice	3 - 6 cups	1 - 3 cups
	Porridge	0.5 - 2 cups	0.5 - 1 cup
	Soup / Slow Cook	3.2 L	1.8 L
Dimensions (Height x Length x Width) (approx.)		241 x 385 x 261 mm	201 x 385 x 261 mm
Weight (approx.)		3.4 kg	3.1 kg
Keep Warm		5 hours	

- For power cord replacement and product repairing, please contact Panasonic authorised service centre.
- The design and specifications are subjected to change without prior notice.

	Cooking time (approximate)*1
White Rice	40 min.
Jasmine	35 min.
Multi Grain	45 min.
Claypot	35 min.
Quick Cook *2	15 min.
Brown Rice	120 min.
Sticky Rice	40 min.
Porridge	60 min.

\*1 Cooking time may vary depending on supply voltage, room temperature, kind of rice, cooking quantity, water quantity and water temperature.

\*2 Rice cooked (white rice at minimum cooking quantity) within 15 minutes. (Under Panasonic test method)



# Panasonic Warranty

## Home Appliance 12 Month Warranty from Date of Purchase

1. Subject to the conditions of this warranty Panasonic or its Authorised Service Centre will perform necessary service on the product without charge for parts or labour, if in the opinion of Panasonic, the product is found to be faulty within the warranty period. For Line Communications products (i.e. Cordless Phones, etc) the genuine battery(s) has a 3 month warranty.
2. This warranty only applies to Panasonic products purchased in Australia and sold by Panasonic Australia or its Authorised Distributors or Dealers and only where the products are used and serviced within Australia or its territories. Warranty cover only applies to service carried out by a Panasonic Authorised Service Centre and only if valid proof of purchase is presented when warranty service is requested.
3. This warranty only applies if the product has been installed and used in accordance with the manufacturer's recommendations (as noted in the operating instructions) under normal use and reasonable care (in the opinion of Panasonic). The warranty covers normal domestic use only (also Clip & Trim Professional use) and does not cover damage, malfunction or failure resulting from use of incorrect voltages, incorrect installation, accident, misuse, neglect, build-up of dirt or dust, abuse, maladjustment of customer controls, mains supply problems, thunderstorm activity, infestation by insects or vermin, tampering or repair by unauthorised persons (including unauthorised alterations), exposure to abnormally corrosive conditions or any foreign object or matter having entered the product.
4. This warranty does not cover the following items unless the fault or defect existed at the time of purchase:
  - (a) Cabinet Parts
  - (b) Microwave Oven cook plates.
  - (c) User replaceable Batteries
  - (d) Kneader mounting shaft unit and Heads, Cutters, Foils, Blades and other accessories.
  - (e) Noise or vibration that is considered normal
5. To claim warranty service, when required, you should:
  - Telephone Panasonic's Customer Care Centre on 132600 or visit our website referred to below and use the Service Centre Locator for the name/address of the nearest Authorised Service Centre.
  - Send or take the product to a Panasonic Authorised Service Centre together with your proof of purchase receipt as a proof of purchase date. Please note that freight and insurance to and / or from your nearest Authorised Service Centre must be arranged by you.
6. The warranties hereby conferred do not extend to, and exclude, any costs associated with the installation, de-installation or re-installation of a product, including costs related to the mounting, de-mounting or remounting of any screen, (and any other ancillary activities), delivery, handling, freighting, transportation or insurance of the product or any part thereof or replacement of and do not extend to, and exclude, any damage or loss occurring by reason of, during, associated with, or related to such installation, de-installation, re-installation or transit.

Panasonic Authorised Service Centres are located in major metropolitan areas and most regional centres of Australia, however, coverage will vary dependant on product. For advice on exact Authorised Service Centre locations for your product, please telephone our Customer Care Centre on 132600 or visit our website and use the Service Centre Locator.

In addition to your rights under this warranty, Panasonic products come with consumer guarantees that cannot be excluded under the Australian Consumer Law. If there is a major failure with the product, you can reject the product and elect to have a refund or to have the product replaced or if you wish you may elect to keep the goods and be compensated for the drop in value of the goods. You are also entitled to have the product repaired or replaced if the product fails to be of acceptable quality and the failure does not amount to a major failure.

If there is a major failure in regard to the product which cannot be remedied then you must notify us within a reasonable period by contacting the Panasonic Customer Care Centre. If the failure in the product is not a major failure then Panasonic may choose to repair or replace the product and will do so in a reasonable period of time from receiving notice from you.

**THIS WARRANTY CARD AND THE PURCHASE DOCKET (OR SIMILAR PROOF OF PURCHASE)  
SHOULD BE RETAINED BY THE CUSTOMER AT ALL TIMES**

If you require assistance regarding warranty conditions or any other enquiries, please visit the **Panasonic Australia** website **www.panasonic.com.au** or contact by phone on **132 600**  
*If phoning in, please ensure you have your operating instructions available.*

**Panasonic Australia Pty. Limited**

ACN 001 592 187 ABN 83 001 592 187

1 Innovation Road, Macquarie Park NSW 2113  
www.panasonic.com.au

# Panasonic Warranty

## Home Appliance 12 Month Warranty from Date of Purchase

1. Subject to the conditions of this warranty Panasonic or its Authorised Service Centre will perform necessary service on the product without charge for parts or labour, if in the opinion of Panasonic, the product is found to be faulty within the warranty period. For Line Communications products (i.e. Cordless Phones, etc) the genuine battery(s) has a 3 month warranty.
2. This warranty only applies to Panasonic products purchased in New Zealand and sold by Panasonic New Zealand or its Authorised Distributors or Dealers and only where the products are used and serviced within New Zealand or its territories. Warranty cover only applies to service carried out by a Panasonic Authorised Service Centre and only if valid proof of purchase is presented when warranty service is requested.
3. This warranty only applies if the product has been installed and used in accordance with the manufacturer's recommendations (as noted in the operating instructions) under normal use and reasonable care (in the opinion of Panasonic). The warranty covers normal domestic use only (also Clip & Trim Professional use) and does not cover damage, malfunction or failure resulting from use of incorrect voltages, incorrect installation, accident, misuse, neglect, build-up of dirt or dust, abuse, maladjustment of customer controls, mains supply problems, thunderstorm activity, infestation by insects or vermin, tampering or repair by unauthorised persons (including unauthorised alterations), exposure to abnormally corrosive conditions or any foreign object or matter having entered the product.
4. This warranty does not cover the following items unless the fault or defect existed at the time of purchase:
  - (a) Cabinet Parts
  - (b) Microwave Oven cook plates.
  - (c) User replaceable Batteries from wear and tear in normal use
  - (d) Kneader mounting shaft unit and Heads, Cutters, Foils, Blades and other accessories.
  - (e) Noise or vibration that is considered normal
5. To claim warranty service, when required, you should:
  - Telephone Panasonic's Customer Care Centre on 09 2720178 or visit our website referred to below and use the Service Centre Locator for the name/address of the nearest Authorised Service Centre.
  - Send or take the product to a Panasonic Authorised Service Centre together with your proof of purchase receipt as a proof of purchase date. Please note that freight and insurance to and / or from your nearest Authorised Service Centre must be arranged by you.
6. The warranties hereby conferred do not extend to, and exclude, any costs associated with the installation, de-installation or re-installation of a product, including costs related to the mounting, de-mounting or remounting of any screen, (and any other ancillary activities), delivery, handling, freighting, transportation or insurance of the product or any part thereof or replacement of and do not extend to, and exclude, any damage or loss occurring by reason of, during, associated with, or related to such installation, de-installation, re-installation or transit.

Panasonic Authorised Service Centres are located in major metropolitan areas and most regional centres of New Zealand, however, coverage will vary dependant on product. For advice on exact Authorised Service Centre locations for your product, please telephone our Customer Care Centre on 09 2720178 or visit our website and use the Service Centre Locator.

Unless otherwise specified to the consumer the benefits conferred by this express warranty are additional to all other conditions, warranties, guarantees, rights and remedies expressed or implied by the Consumer Guarantees Act of New Zealand and all other obligations and liabilities on the part of the manufacturer or supplier and nothing contained herein shall restrict or modify such rights, remedies, obligations and liabilities.

**THIS WARRANTY CARD AND THE PURCHASE DOCKET (OR SIMILAR PROOF OF PURCHASE) SHOULD BE RETAINED BY THE CUSTOMER AT ALL TIMES**

If you require assistance regarding warranty conditions or any other enquiries, please visit the **Panasonic New Zealand** website [www.panasonic.co.nz](http://www.panasonic.co.nz) or contact by phone on **09 2720178**  
*If phoning in, please ensure you have your operating instructions available.*

### **Panasonic New Zealand Customer Care Centre**

Phone: 09 2720178

Fax: 09 2720129

Email: [customerservice@nz.panasonic.com](mailto:customerservice@nz.panasonic.com)

Website: [www.panasonic.co.nz/support](http://www.panasonic.co.nz/support)



Panasonic Appliances (Thailand) Co., Ltd.  
Website : <http://www.panasonic.com>  
© Panasonic Appliances (Thailand) Co., Ltd. 2015

RZ19ZZ061  
T0615-1075  
Printed in Thailand