

Panasonic[®]

Operating Instructions Digital Wireless Stereo Headphones

Model No. **RB-HF520B**
RB-HF420B

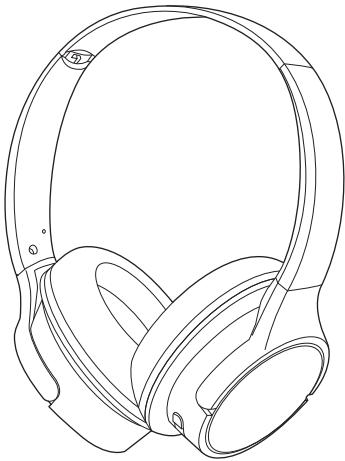

RB-HF520B

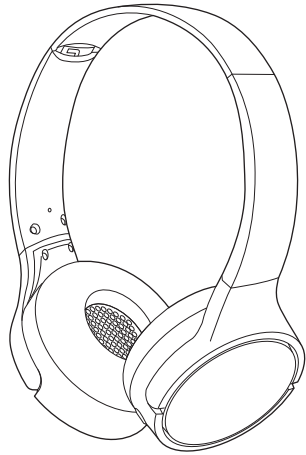

RB-HF420B



Thank you for purchasing this product.
Please read these instructions carefully before using this product, and save this manual for future use.

Safety precautions

■ Unit

WARNING:

To reduce the risk of fire, electric shock or product damage,

- Do not expose this unit to rain, moisture, dripping or splashing.
- Do not place objects filled with liquids, such as vases, on this unit.
- Use the recommended accessories.
- Do not remove covers.
- Do not repair this unit by yourself. Refer servicing to qualified service personnel.

Avoid the use in the following conditions

- High or low extreme temperatures during use, storage or transportation.
- Disposal of a battery into fire or a hot oven, or mechanically crushing or cutting of a battery, that can result in an explosion.
- Extremely high temperature and/or extremely low air pressure that can result in an explosion or the leakage of flammable liquid or gas.

- Avoid using or placing this unit near sources of heat.
- Do not listen with this unit at high volume in places where you need to hear sounds from the surrounding environment for safety, such as at railroad crossings, and construction sites.

■ Allergies

- Discontinue use if you experience discomfort with the ear pads or any other parts that directly contact your skin.
- Continued use may cause rashes or other allergic reactions.

■ Precautions for listening with the Headphones

- Excessive sound pressure from earphones and headphones can cause hearing loss.
- Do not use your headphones at a high volume. Hearing experts advise against continuous extended play.
- If you experience a ringing in your ears, reduce volume or discontinue use.
- Do not use while operating a motorised vehicle. It may create a traffic hazard and is illegal in many areas.
- You should use extreme caution or temporarily discontinue use in potentially hazardous situations.

This unit may receive radio interference caused by mobile telephones during use. If such interference occurs, please increase separation between this unit and the mobile telephone.

Use only the supplied USB charging cord when connecting to a computer.

This unit is intended for use in moderate and tropical climates.

About Bluetooth®

Panasonic bears no responsibility for data and/or information that is compromised during a wireless transmission.

■ Frequency band used

This unit uses the 2.4 GHz frequency band.

■ Certification of this unit

- This unit conforms to frequency restrictions and has received certification based on frequency laws. Thus, a wireless permit is not necessary.
- The actions below are punishable by law in some countries:
 - Taking apart/modifying this unit.
 - Removing specification indications.

■ Restrictions of use

- Wireless transmission and/or usage with all Bluetooth® equipped devices is not guaranteed.
- All devices must conform to standards set by Bluetooth SIG, Inc.
- Depending on the specifications and settings of a device, it can fail to connect or some operations can be different.
- This unit supports Bluetooth® security features. But depending on the operating environment and/or settings, this security may not be sufficient. Transmit data wirelessly to this unit with caution.
- This unit cannot transmit data to a Bluetooth® device.

■ Range of use

Use this unit at a maximum range of 10 m.

The range can decrease depending on the environment, obstacles or interference.

■ Interference from other devices

- This unit may not function properly and troubles such as noise and sound jumps may arise due to radio wave interference if this unit is located too close to other Bluetooth® devices or the devices that use the 2.4 GHz band.
- This unit may not function properly if radio waves from a nearby broadcasting station, etc. is too strong.

■ Intended usage

- This unit is for normal, general use only.
- Do not use this system near an equipment or in an environment that is sensitive to radio frequency interference (example: airports, hospitals, laboratories, etc.).

Table of contents

Safety precautions	2
About Bluetooth®	3
Before use	
<hr/>	
Accessories	5
Maintenance.....	5
• Folding this unit	5
Part names	6
Preparation	
<hr/>	
Charging.....	7
Turning the power on/off	7
Connecting a Bluetooth® device	8
• Pairing (Registration) this unit with the Bluetooth® device for connection	8
• Connecting a paired Bluetooth® device	9
Operation	
<hr/>	
Listening to music	10
• Remote controlling.....	10
Making a phone call	11
Useful functions.....	12
• Activating voice functions	12
• Resetting the unit	12
• Auto power off	12
• Battery level notification.....	12
• Guidance messages.....	12
Other	
<hr/>	
Restoring to the factory settings.....	13
Copyright, etc.	13
Troubleshooting.....	14
• Sound and audio volume.....	14
• Bluetooth® device connection.....	14
• Phone Calls	14
• General.....	15
• Power supply and charging	15
Specifications	16
To remove the battery when disposing of this unit	17

Expressions used in this document

- Pages to be referred to are indicated as “→ ○○”.
- The product illustrations may differ from the actual product.
- Unless otherwise indicated, illustrations in these operating instructions are of RB-HF520B.

Marks denoting model names

Functionality differences between models are indicated with the model marks below.

RB-HF520B: **RB-HF520B** RB-HF420B: **RB-HF420B**

Accessories

Please check and identify the supplied accessories.

1 x USB charging cord

Maintenance

Clean this unit with a dry and soft cloth.

- Do not use solvents including benzene, thinner, alcohol, kitchen detergent, a chemical wiper, etc. This might cause the exterior case to be deformed or the coating to come off.

Keeping the battery performance

- During the long period of disuse, full charge this unit once every 6 months to keep the battery performance.

Folding this unit

Fold the headphones as shown below. Improper folding may result in a malfunction.

- If the USB charging cord (supplied) is connected, disconnect it from the unit.

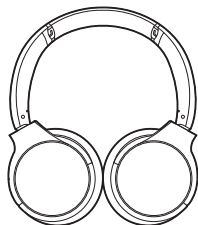

Part names

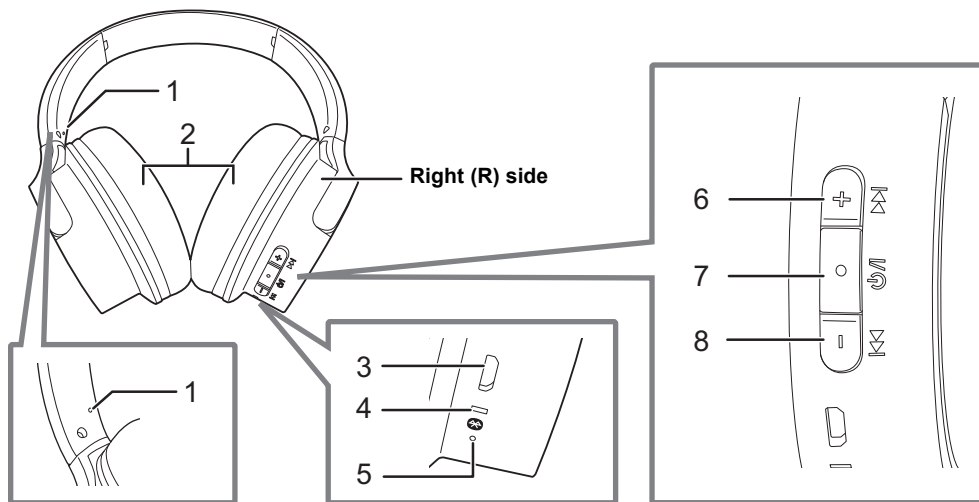

- | | |
|--|--|
| <p>1 Raised dot indicating the left side</p> <p>2 Ear pads</p> <p>3 Charging terminal (DC IN)</p> <ul style="list-style-type: none"> • Connect the USB charging cord (supplied) to this terminal when charging. (→ 7) <p>4 LED indicator light^{*1*2}</p> | <p>5 Microphone</p> <p>6 [+ (▶▶)] button</p> <p>7 [⏻ (⏻/)] button^{*3}</p> <p>8 [- (◀◀)] button</p> |
|--|--|

*1 Hereafter referred to as “LED”

*2 Examples of lighting/blinking patterns

Lighting (red):	Charging is in progress
Lighting alternately in blue and red:	Bluetooth® pairing (registration) standby
Blinking slowly (blue) ^{*4} :	Bluetooth® connection standby
Blinking twice about every 2 seconds (blue) ^{*4} :	A Bluetooth® pairing (registration) has been established or a call is in progress
Blinking (blue) ^{*4} :	A call is being received

*3 ⏻/|: Standby/ON, ⏻, ▶▶/||/⏻

*4 The battery is low when it is blinking in red. (→ 12, “Battery level notification”)

Charging

The rechargeable battery (installed in the unit) is not charged initially. Charge the battery before using the unit.

Connect this unit to a computer using the USB charging cord.

- A:** LED
 - B:** USB charging cord (supplied)
 - Check the direction of the terminals and plug in/out straight holding onto the plug. (It may result in malfunction by the deforming of the terminal if it is plugged in obliquely or in wrong direction.)
 - C:** Computer
 - Turn on the computer in advance.
- The LED lights in red when charging is in progress. When charging is completed, the LED will go out.
 - It takes approx. 4 hours to charge the battery from empty to full.

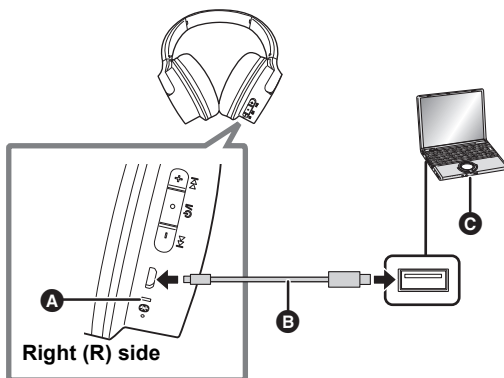

Note

- Charging does not take place when the battery is near full charge. Connecting the USB charging cord may cause the LED to light only for a moment, but this is not a malfunction.
- The Bluetooth® feature cannot be used when this unit is connected to a computer using the USB charging cord.
- Charge in a room temperature between 10 °C and 35 °C. Outside of this temperature range, charging may stop and the LED may go out.
- The power cannot be turned on while charging.
- Do not use any other USB charging cords except the supplied one. Doing so may cause malfunction.
- Charging may not be performed or may stop if the computer is in or switched to standby or sleep mode.

Turning the power on/off

In the power-off state, press and hold [] of this unit for approx. 3 seconds until the LED (blue) blinks.

- A beep will sound, and the LED (blue) will blink slowly.

■ To turn the power off

Press and hold [] for approximately 3 seconds. An English guidance message will be heard, and the power will be turned off.

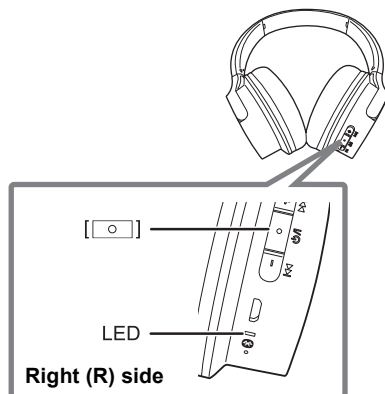

Note

- If the unit is not connected to a Bluetooth® device, an English guidance message will be heard and turn off the unit automatically approximately 5 minutes after you have stopped using it. (→ 12, "Auto power off")

Connecting a Bluetooth® device

Preparation

- Place the Bluetooth® device within approx. 1 m from the unit.
- Check the device operation using its operation instructions as required.

Pairing (Registration) this unit with the Bluetooth® device for connection

1 In the power-off state, press and hold [] of this unit until the LED blinks.

When pairing a device for the first time: approx. 3 seconds

When pairing a second or subsequent devices: approx. 5 seconds

- The unit starts to search for the Bluetooth® device for connection, and the LED will light alternately in blue and red.

2 Turn on the power of the Bluetooth® device, and enable the Bluetooth® function.

3 Select “RB-HF520B” or “RB-HF420B” from the Bluetooth® device’s menu.

- A BD address (Bluetooth® Device address: an alphanumeric character string that is displayed by and unique to the device) may be displayed before “RB-HF520B” or “RB-HF420B” is displayed.
- If prompted for a passkey, input the passkey “0000 (four zeros)” of this unit.

e.g. **RB-HF520B**

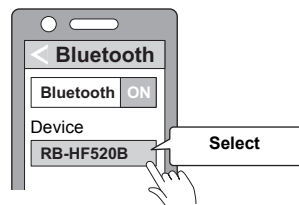

4 Check the connection with the Bluetooth® device on the unit.

- The LED will light alternately in blue and red until the connection with the device is completed. When the LED (blue) blinks twice every approx. 2 seconds, pairing (registration) is completed. (Connection established)

Note

- If connection to a device is not established within approximately 5 minutes, the unit will be turned off. Perform pairing again.
- You can pair up to 8 Bluetooth® devices with this unit. If a 9th device is paired, the device with the oldest connection will be replaced. To use it, perform pairing again.

Connecting a paired Bluetooth® device**1 Turn on this unit.**

- Press and hold [] of this unit for approx. 3 seconds until the LED (blue) blinks.
- A beep will sound, and the LED (blue) will blink slowly.

2 Perform steps 2 and 3 of “Pairing (Registration) this unit with the Bluetooth® device for connection”. (→ 8)

- When the LED (blue) blinks twice every approx. 2 seconds, pairing (registration) is completed. (Connection established)

Note

- This unit remembers the device lastly connected. Connection may be automatically established after step 1 (see above).
- If connection to a device is not established within approximately 5 minutes, the unit will be turned off. Turn on the unit again.

Listening to music

If the Bluetooth® compatible device supports the “A2DP” and “AVRCP” Bluetooth® profiles, music can be played back with remote control operations on the unit.

- A2DP (Advanced Audio Distribution Profile): Transmits audio to the unit.
- AVRCP (Audio/Video Remote Control Profile): Allows remote control of the device using the unit.

1 Connect the Bluetooth® device and the unit. (→ 8, “Connecting a Bluetooth® device”)

2 Select and play the music on the Bluetooth® device.

- The unit's headphones will output the music or the audio of the video being played back.
- Operating time:
The maximum playback time is approximately 50 hours. (It may become shorter depending on the usage conditions.)

■ Attention

- The unit might leak sound depending on the volume level.
- When the volume is increased to near maximum level, music may sound distorted. Decrease the volume until the distortion is cleared.

Remote controlling





You can control the Bluetooth® device using the unit.

- Depending on the Bluetooth® device or the app, even if you press buttons on the unit, some functions may not respond or may operate differently from the descriptions below.

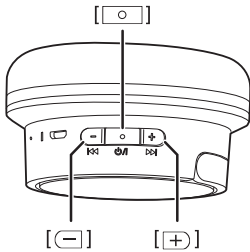
(Operation example)

Right (R) side



Function	Operation
Play / Pause	Press [].
Increase the volume	Press [].
Decrease the volume	Press [].
Forward to the start of next track	Press and hold [] for approximately 2 seconds.
Return to the start of current track	Press and hold [] for approximately 2 seconds.

Note

- The volume can be adjusted in 17 levels. When the maximum or minimum volume is reached, a beep will sound.

Making a phone call

With Bluetooth® enabled phones (cell phones or smartphones) that support the “HFP” Bluetooth® profile, you can use the unit for phone calls.

• HFP (Hands-Free Profile):

This profile has the incoming and outgoing calls function.

(This unit does not have a function that allows you to make phone calls independently of a Bluetooth® enabled phone.)

1 Connect the Bluetooth® device and the unit. (→ 8, “Connecting a Bluetooth® device”)

2 Press [] on the unit and answer the incoming call.

- During an incoming call, ringtone will sound from the unit and the LED will blink.
- (HFP only) To reject the incoming call, press [] twice quickly.

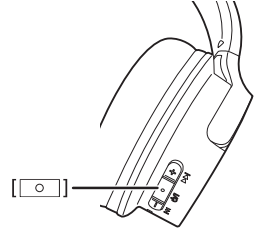

3 Start talking.

- The LED will repeatedly blink 2 times during a call.
- The volume can be adjusted during a phone call. For setting instructions, see page 10.

4 Press [] to end the phone call.

- A beep will sound.

Note

- There may be instances when hands free setting needs to be done on the Bluetooth® enabled phone.
- Depending on the Bluetooth® enabled phone, you may hear incoming and outgoing call ringtones of the phone from the unit.
- (HFP only) It may be difficult to hear phone conversations when the unit is used in locations with loud ambient noise or in outdoor or other locations exposed to powerful winds. In that case, change the calling location or switch the calling device to the Bluetooth® enabled phone to continue the call. (Press [] on the unit twice quickly to switch.)
- You can have the Bluetooth® enabled phone make phone calls by using the microphone of the unit and an app of the Bluetooth® enabled phone. (→ 12, “Activating voice functions”)

Useful functions

Activating voice functions

You can activate Siri or other voice functions with a button on the unit.

- 1 Connect the Bluetooth® device and the unit. (→ 8, “Connecting a Bluetooth® device”)**
- 2 Press [] of this unit twice quickly.**
 - The voice function on the Bluetooth® device will be activated.

Note

- For details about voice function commands, refer to the operating instructions for the Bluetooth® device.
- The voice function may not work depending on the smartphone specifications and the app version.

Resetting the unit

This unit can be reset when all operations are rejected. To reset the unit, connect the unit to a computer using the USB charging cord. (The pairing device information will not be deleted.)

Auto power off

If the unit is not connected to a Bluetooth® device, an English guidance message will be heard and turn off automatically approximately 5 minutes after you have stopped using it.

Battery level notification

- When the unit is turned off, an English guidance message will be heard indicating the battery level.
- When the battery level starts to run low, the blinking LED will turn from blue to red, and as it drops further, you will be notified by one beep every 1 minute. When the battery runs out, an English guidance message will be heard and the power will turn off.



Guidance messages

The unit is equipped with an a function that provides an audio notification when you turn off the unit, connect a Bluetooth® device or change a setting, for example.

- The audio guidance function cannot be disabled.
- The audio guidance volume cannot be adjusted.

Restoring to the factory settings

When you want to delete all pairing device information, etc., you can restore the unit to the factory settings (original settings upon purchase). Charge the battery before restoring the unit.

- 1 While the unit is turned off, press and hold [] for at least 5 seconds until the LED starts lighting alternately in blue and red.**
- 2 While the LED is lighting alternately in blue and red, press and hold [] and [] at the same time for at least 5 seconds.**

- The default settings will be restored after the LED (blue) blinks fast and the unit turns off.

■ Attention

- When pairing a device again, delete the registering information (Device: “RB-HF520B” or “RB-HF420B”) from the Bluetooth® device’s menu, and register this unit with the Bluetooth® device again. (→ 8)

Copyright, etc.

The Bluetooth® word mark and logos are registered trademarks owned by Bluetooth SIG, Inc. and any use of such marks by Panasonic Corporation is under license.

Other trademarks and trade names are those of their respective owners.

Siri is a trademark of Apple Inc., registered in the U.S. and other countries.

Other system names and product names appearing in this document are in general the registered trademarks or trademarks of the respective developer companies.

Note that the ™ mark and ® mark do not appear in this document.

Troubleshooting

Before requesting service, make the following checks. If you are in doubt about some of the check points, or if the remedies indicated do not solve the problem, consult your dealer for instructions.

Sound and audio volume

No sound.

- Make sure that the unit and the Bluetooth® device are connected correctly. (→ 8)
- Check if music is playing on the Bluetooth® device.
- Make sure that the unit is turned on and the volume is not set too low.
- Pair and connect the Bluetooth® device and the unit again. (→ 8)
- Check if the Bluetooth® compatible device supports “A2DP” profile. For details on profiles, see “Listening to music” (→ 10). Also refer to the operating manual for the Bluetooth® compatible device.

Low volume.

- Increase the volume of the unit. (→ 10)
- Increase the volume on the Bluetooth® device.

Sound from the device is cut off. / Too much noise. / Sound quality is bad.

- Sound may be disrupted if signals are blocked. Do not fully cover this unit with the palm of your hand, etc.
- The device may be out of the 10 m communication range. Move the device closer to this unit.
- Remove any obstacle between this unit and the device.
- Switch off any wireless LAN device when not in use.
- A communication problem may arise if the battery is not fully charged. Charge the unit. (→ 7)

Bluetooth® device connection

The device cannot be connected.

- Delete the pairing information for this unit from the Bluetooth® device, then pair them again. (→ 8)

Phone Calls

You cannot hear the other person.

- Make sure that the unit and the Bluetooth® enabled phone are turned on.
- Check if the unit and the Bluetooth® enabled phone are connected. (→ 8)
- Check the audio settings of the Bluetooth® enabled phone. Switch the calling device to the unit if it is set to the Bluetooth® enabled phone. (→ 8)
- If the volume of the other person’s voice is too low, increase the volume of both the unit and the Bluetooth® enabled phone.

Cannot make a phone call.

- Check if the Bluetooth® compatible device supports “HFP” profile. For details on profiles, see “Listening to music” (→ 10) and “Making a phone call” (→ 11). Also refer to the operating manual for the Bluetooth® enabled phone.

General

The unit does not respond.

- This unit can be reset when all operations are rejected. To reset the unit, connect the unit to a computer using the USB charging cord. (The pairing device information will not be deleted.)

Power supply and charging

Cannot charge the unit.

- Make sure the computer is turned on and is not on standby or sleep mode.
- Is the USB port you are currently using working properly? If your computer has other USB ports, unplug the connector from its current port and plug it into one of the other ports.
- If the measures mentioned above are not applicable, unplug the USB charging cord and plug it in again.
- If the charge time and operating time become shortened, the battery may have run down. (Number of charging times of the installed battery: Approximately 300)

LED does not light during charging. / Charging takes longer.

- Is the USB charging cord connected firmly to the USB terminal of the computer? (→ 7)
- Make sure to charge in a room temperature between 10 °C and 35 °C.
- Charging does not take place when the battery is near full charge.
- When the battery is near full charge, connecting the USB charging cord will cause the LED to light only for a moment.

The power does not turn on.

- Is the unit being charged? The power cannot be turned ON during charging. (→ 7)

Specifications

■ General

Power supply	DC 5 V, 400 mA (Internal battery: 3.7 V (Li-polymer))
Operating time *1	Approx. 50 hours
Charging time *2 (25 °C)	Approx. 4 hours
Charging temperature range	10 °C to 35 °C
Operating temperature range	0 °C to 40 °C
Operating humidity range	35 %RH to 80 %RH (no condensation)
Mass	RB-HF520B Approx. 205 g RB-HF420B Approx. 155 g

*1 It may be shorter depending on the operating conditions.

*2 The time required to charge the battery from empty to full.

■ Bluetooth® section

Bluetooth® system specification	Ver. 5.0
Wireless equipment classification	Class 2 (2.5 mW)
Max RF power	4 dBm
Frequency band	2402 MHz to 2480 MHz
Supported profiles	A2DP, AVRCP, HFP
Supported codec	SBC
Operating distance	Up to 10 m

■ Speaker section

Driver units	RB-HF520B 40 mm RB-HF420B 30 mm
---------------------	--

■ Terminal section

DC IN	DC 5 V, 400 mA
--------------	----------------

■ Microphone section

Type	Mono
-------------	------

■ Accessory section

USB Charging Cord (Input Plug: USB A Shape, Output Plug: micro USB Shape)	Approx. 0.5 m
--	---------------

• Specifications are subject to change without notice.

To remove the battery when disposing of this unit

The following instructions are not intended for repairing purposes but for the disposal of this unit. This unit is not restorable once disassembled.

• When disposing of this unit, take out the battery installed in this unit and recycle it.

- Disassemble after the battery runs out.
- Keep disassembled parts out of reach of children.

Regarding the handling of used batteries

- Insulate the terminals with adhesive tape or similar material.
- Do not disassemble.

■ Batteries

- Do not heat or expose to flame.
- Do not leave the battery(ies) in a car exposed to direct sunlight for a long period of time with doors and windows closed.
- Battery mishandling can cause electrolyte leakage which can damage items the leaked fluid comes into contact with. If electrolyte leaks from the battery, consult your dealer. Wash thoroughly with water if electrolyte comes in contact with any part of your body.
- When disposing of the batteries, please contact your local authorities or dealer and ask for the correct method of disposal.

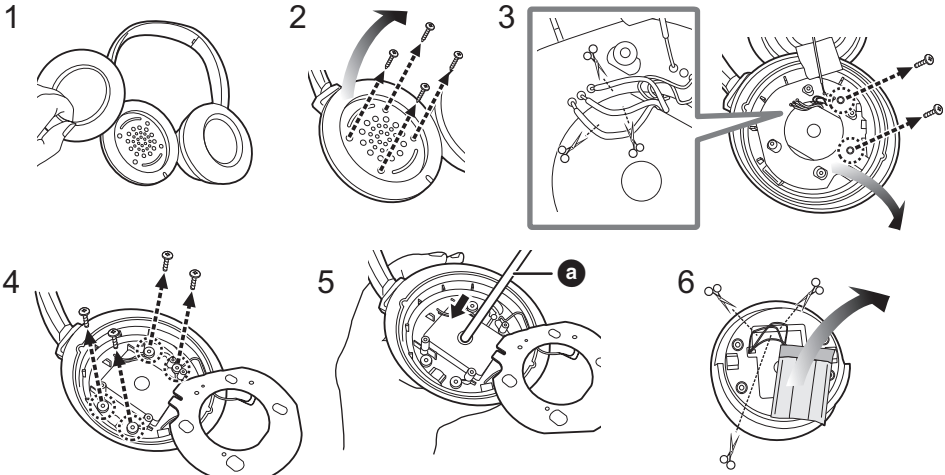

- 1 Remove the right ear pad.**
- 2 Remove the 4 screws and then the plate.**
- 3 Cut the 3 cords (red, blue, black) one by one, and remove the 2 screws and then the board.**
- 4 Remove the 4 screws.**
- 5 Insert a rod-like object that does not have a pointy end (a) into the hole and push the battery out.**
 - Take care not to damage the battery.
- 6 Cut the cords coming out of the battery one by one, and then take out the battery.**

Declaration of Conformity (DoC)

Hereby, "*Panasonic Corporation*" declares that this product is in compliance with the essential requirements and other relevant provisions of Directive 2014/53/EU.

Customers can download a copy of the original DoC to our RE products from our DoC server:

<http://www.ptc.panasonic.eu>

Contact to Authorised Representative:

Panasonic Marketing Europe GmbH,

Panasonic Testing Centre, Winsbergring 15, 22525 Hamburg, Germany

Type of wireless	Frequency band	Maximum power
Bluetooth®	2402 - 2480 MHz	4 dBm

Disposal of Old Equipment and Batteries**Only for European Union and countries with recycling systems**

These symbols on the products, packaging, and/or accompanying documents mean that used electrical and electronic products and batteries must not be mixed with general household waste. For proper treatment, recovery and recycling of old products and used batteries, please take them to applicable collection points in accordance with your national legislation.

By disposing of them correctly, you will help to save valuable resources and prevent any potential negative effects on human health and the environment.

For more information about collection and recycling, please contact your local municipality. Penalties may be applicable for incorrect disposal of this waste, in accordance with national legislation.

**(Note for the battery symbol (bottom symbol)):**

This symbol might be used in combination with a chemical symbol. In this case it complies with the requirement set by the Directive for the chemical involved.

For Thailand only

This telecommunication equipment conforms to NTC/NBTC technical requirement.

For Singapore only

Complies with
IMDA Standards
DB01017

Suomi

■ Varotoimet turvallisuuden takaamiseksi

VAROITUS:

Jotta vähennetään tulipalon, sähköiskun tai tuotteen vahingoittumisen vaaraa,

- Älä anna tämän laitteen altistua sateelle, kosteudelle, pisaroille tai roiskeille.
- Älä laita laitteen päälle mitään nesteitä sisältäviä esineitä kuten maljakot.
- Käytä suositeltuja varusteita.
- Älä poista suojuksia.
- Älä korjaa tätä laitetta itse. Anna huoltopalvelut tehtäväksi pätevälle huoltohenkilöstölle.

Vältä käyttöä seuraavissa olosuhteissa

- Erittäin korkeat tai alaiset lämpötilat käytön, varastoinnin tai kuljetuksen aikana.
- Akkujen heittäminen tuleen tai kuumaan uunin tai niiden mekaaninen murskaaminen tai leikkaaminen voi aiheuttaa räjähdysten.
- Erittäin korkea lämpötila ja/tai erittäin alhainen ilmanpaine voivat aiheuttaa räjähdysten tai syttyvän nesteen tai kaasun vuotamista.

Tämä laite on tarkoitettu käytettäväksi leudoissa ja trooppisissa ilmastoissa.

Vakuutus vaatimustenmukaisuudesta (DoC)

"Panasonic Corporation" vakuuttaa, että tämä tuote on yhdenmukainen direktiiviin 2014/53/EU keskeisten vaatimusten sekä sen muiden merkityksellisten määräysten kanssa.

Asiakkaat voivat ladata alkuperäisen DoC:n kopion RE-tuotteillemme DoC-palvelimelta:

<http://www.ptc.panasonic.eu>

Valtuutetun edustajan yhteystiedot:

Panasonic Marketing Europe GmbH,

Panasonic Testing Centre, Winsbergring 15, 22525 Hamburg, Saksa

Langattoman tyyppi	Taajuuskaista	Enimmäisteho
Bluetooth®	2402 - 2480 MHz	4 dBm

For the United Kingdom and Ireland customers

Sales and Support Information

Customer Communications Centre

- For customers within the UK: 0344 844 3899
- For customers within Ireland: 01 289 8333
- Monday–Friday 9:00 am–5:00 pm (Excluding public holidays).
- For further support on your product, please visit our website:
www.panasonic.co.uk

Direct Sales at Panasonic UK

- Order accessory and consumable items for your product with ease and confidence by phoning our Customer Communications Centre Monday–Friday 9:00 am–5:00 pm (Excluding public holidays).
- Or go on line through our Internet Accessory ordering application at www.pas-europe.com.
- Most major credit and debit cards accepted.
- All enquiries transactions and distribution facilities are provided directly by Panasonic UK.
- It couldn't be simpler!
- Also available through our Internet is direct shopping for a wide range of finished products. Take a browse on our website for further details.

Manufactured by:

Panasonic Corporation
Kadoma, Osaka, Japan

Authorized Representative in Europe:

Panasonic Marketing Europe GmbH
Panasonic Testing Centre
Winsbergring 15, 22525 Hamburg, Germany



Panasonic Corporation

<http://www.panasonic.com>

© Panasonic Corporation 2020

(En)

PNQP1587ZA-2N
F0520MH1060