

Panasonic®

Operating Instructions

Digital Cordless Phone

Model No. **KX-TGK210BX**
KX-TGK210UE

Digital Cordless Answering System

Model No. **KX-TGK220BX**



***Before initial use, see “Getting Started”
on page 8.***

Thank you for purchasing a Panasonic product.

Please read these operating instructions before using the unit and save them for future reference.

Table of Contents

Introduction	
Model composition	3
Accessory information	3
Graphical symbols for use on equipment and their descriptions	4
Important Information	
For your safety	5
Important safety instructions	6
For best performance	6
Other information	7
Specifications	7
Getting Started	
Setting up	8
Controls	10
Display icons	11
Turning the power on/off	12
Language setting	12
Date and time	13
Recording your greeting message	13
Other settings	13
Making/Answering Calls	
Making calls	15
Answering calls	15
Useful features during a call	15
Intercom	17
Key lock	17
Phonebook	
Phonebook	18
Speed dial	19
Programming	
Menu list	21
Alarm	26
Do not disturb mode	26
Nuisance call block	27
Other programming	28
Registering a unit	29
Caller ID Service	
Using Caller ID service	32
Caller list	32
Answering System	
Answering system	34
Turning the answering system on/off	34
Greeting message	34
Listening to messages	35
Remote operation	35
Answering system settings	36
Useful Information	
Voicemail service	38
Character entry	38
Error messages	40
Troubleshooting	40
Index	
Index.....	45

Model composition

Series	Model No.	Base unit	Handset	
		Part No.	Part No.	Quantity
KX-TGK210 series	KX-TGK210	KX-TGK210	KX-TGKA21	1
KX-TGK220 series	KX-TGK220	KX-TGK220	KX-TGKA21	1

Accessory information

Supplied accessories

No.	Accessory item/Part number	Quantity
①	AC adaptor*1	1
②	Telephone line cord	1
③	Rechargeable batteries*2	2
④	Handset cover	1

*1 PNLV226CE: KX-TGK210BX/KX-TGK220BX
PNLV226E: KX-TGK210UE

*2 See page 3 for replacement battery information.



Additional/replacement accessories

Please contact your nearest Panasonic dealer for sales information.

Accessory item	Model number/Specifications
Rechargeable batteries*1	Battery type: – Nickel metal hydride (Ni-MH) – 2 x AAA (R03) size for each handset – 1.2 V – Minimum amperage of 550 mAh
DECT repeater	KX-A405, KX-A406

*1 Replacement batteries may have a different capacity from that of the supplied batteries. We recommend using Panasonic rechargeable batteries.

Introduction













Other information

- Design and specifications are subject to change without notice.
- The illustrations in these instructions may vary slightly from the actual product.

Note:

- You can purchase KX-TGK210 separately and use it as an optional handset.
At first, deregister the handset from the base unit additionally purchased (page 30), then re-register it to the base unit which is currently used (page 30).
Additional base unit is used as charger.
 - You do not have to connect the telephone line cord to additional base unit.
 - **[••]** of additional base unit is not available.

Graphical symbols for use on equipment and their descriptions

Symbol	Explanation	Symbol	Explanation
	Alternating current (A.C.)		Class II equipment (equipment in which protection against electric shock relies on Double Insulation or Reinforced Insulation)
	Direct current (D.C.)		"ON" (power)
	Protective earth		"OFF" (power)
	Protective bonding earth		Stand-by (power)
	Functional earth		"ON"/"OFF" (power; push-push)
	For indoor use only		Caution, risk of electric shock

Important Information

For your safety

To prevent severe injury and loss of life/property, read this section carefully before using the product to ensure proper and safe operation of your product.

WARNING

Power connection

- Use only the power source marked on the product.
- Do not overload power outlets and extension cords. This can result in the risk of fire or electric shock.
- Completely insert the AC adaptor/power plug into the power outlet. Failure to do so may cause electric shock and/or excessive heat resulting in a fire.
- Regularly remove any dust, etc. from the AC adaptor/power plug by pulling it from the power outlet, then wiping with a dry cloth. Accumulated dust may cause an insulation defect from moisture, etc. resulting in a fire.
- Unplug the product from power outlets if it emits smoke, an abnormal smell, or makes an unusual noise. These conditions can cause fire or electric shock. Confirm that smoke has stopped emitting and contact an authorised service centre.
- Unplug from power outlets and never touch the inside of the product if its casing has been broken open.
- Never touch the plug with wet hands. Danger of electric shock exists.

Installation

- To prevent the risk of fire or electrical shock, do not expose the product to rain or any type of moisture.
- Do not place or use this product near automatically controlled devices such as automatic doors and fire alarms. Radio waves emitted from this product may cause such devices to malfunction resulting in an accident.

- Do not allow the AC adaptor or telephone line cord to be excessively pulled, bent or placed under heavy objects.

Operating safeguards

- Unplug the product from power outlets before cleaning. Do not use liquid or aerosol cleaners.
- Do not disassemble the product.
- Do not spill liquids (detergents, cleansers, etc.) onto the telephone line cord plug, or allow it to become wet at all. This may cause a fire. If the telephone line cord plug becomes wet, immediately pull it from the telephone wall jack, and do not use.

Medical

- Consult the manufacturer of any personal medical devices, such as pacemakers or hearing aids, to determine if they are adequately shielded from external RF (radio frequency) energy. (The product operates in the frequency range of 1.88 GHz to 1.90 GHz, and the RF transmission power is 250 mW (max.).)
- Do not use the product in health care facilities if any regulations posted in the area instruct you not to do so. Hospitals or health care facilities may be using equipment that could be sensitive to external RF energy.

CAUTION

Installation and location

- Never install telephone wiring during an electrical storm.
- Never install telephone line jacks in wet locations unless the jack is specifically designed for wet locations.
- Never touch uninsulated telephone wires or terminals unless the telephone line has been disconnected at the network interface.
- Use caution when installing or modifying telephone lines.
- The AC adaptor is used as the main disconnect device. Ensure that the AC outlet is installed near the product and is easily accessible.

Important Information

- This product is unable to make calls when:
 - the handset batteries need recharging or have failed.
 - there is a power failure.
 - the key lock feature is turned on.

Battery

- We recommend using the batteries noted on page 3. **USE ONLY rechargeable Ni-MH batteries AAA (R03) size.**
- Do not mix old and new batteries.
- Do not open or mutilate the batteries. Released electrolyte from the batteries is corrosive and may cause burns or injury to the eyes or skin. The electrolyte is toxic and may be harmful if swallowed.
- Exercise care when handling the batteries. Do not allow conductive materials such as rings, bracelets, or keys to touch the batteries, otherwise a short circuit may cause the batteries and/or the conductive material to overheat and cause burns.
- Charge the batteries provided with or identified for use with this product only, in accordance with the instructions and limitations specified in this manual.
- Only use a compatible base unit (or charger) to charge the batteries. Do not tamper with the base unit (or charger). Failure to follow these instructions may cause the batteries to swell or explode.

Important safety instructions

When using your product, basic safety precautions should always be followed to reduce the risk of fire, electric shock, and injury to persons, including the following:

1. Do not use this product near water for example, near a bathtub, washbowl, kitchen sink, or laundry tub, in a wet basement or near a swimming pool.
2. Avoid using a telephone (other than a cordless type) during an electrical storm. There may be a remote risk of electric shock from lightning.
3. Do not use the telephone to report a gas leak in the vicinity of the leak.

4. Use only the power cord and batteries indicated in this manual. Do not dispose of batteries in a fire. They may explode. Check with local codes for possible special disposal instructions.

SAVE THESE INSTRUCTIONS

For best performance

Base unit location/avoiding noise

The base unit and other compatible Panasonic units use radio waves to communicate with each other.

- For maximum coverage and noise-free communications, place your base unit:
 - at a convenient, high, and central location with no obstructions between the handset and base unit in an indoor environment.
 - away from electronic appliances such as TVs, radios, personal computers, wireless devices, or other phones.
 - facing away from radio frequency transmitters, such as external antennas of mobile phone cell stations. (Avoid putting the base unit on a bay window or near a window.)
- Coverage and voice quality depends on the local environmental conditions.
- If the reception for a base unit location is not satisfactory, move the base unit to another location for better reception.

Environment

- Keep the product away from electrical noise generating devices, such as fluorescent lamps and motors.
- The product should be kept free from excessive smoke, dust, high temperature, and vibration.
- The product should not be exposed to direct sunlight.
- Do not place heavy objects on top of the product.
- When you leave the product unused for a long period of time, unplug the product from the power outlet.
- The product should be kept away from heat sources such as heating devices, cooking

Important Information

appliances, etc. It should not be placed in rooms where the temperature is less than 0 °C or greater than 40 °C. Damp basements should also be avoided.

- The maximum calling distance may be shortened when the product is used in the following places: Near obstacles such as hills, tunnels, underground, near metal objects such as wire fences, etc.
- Operating the product near electrical appliances may cause interference. Move away from the electrical appliances.

Routine care

- **Wipe the outer surface of the product with a soft moist cloth.**
- Do not use benzine, thinner, or any abrasive powder.

Other information

CAUTION: Risk of explosion if battery is replaced by an incorrect type. Dispose of used batteries according to the instructions.

Notice for product disposal, transfer, or return

- This product can store your private/confidential information. To protect your privacy/confidentiality, we recommend that you erase information such as phonebook or caller list entries from the memory before you dispose of, transfer, or return the product.

Information on Disposal in other Countries outside the European Union

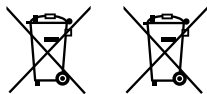

These symbols are only valid in the European Union. If you wish to discard these items,

please contact your local authorities or dealer and ask for the correct method of disposal.

Note for the battery removal procedure

Refer to "Removing the handset cover and battery" on page 9.

Specifications

- **Standard:**
DECT (Digital Enhanced Cordless Telecommunications),
GAP (Generic Access Profile)
- **Frequency range:**
1.88 GHz to 1.90 GHz
- **RF transmission power:**
Approx. 10 mW (average power per channel)
250 mW (max.)
- **Power source:**
100–240 V AC, 50/60 Hz
- **Power consumption:**
Base unit:
Standby: 0.5 W
Maximum: 2.5 W
- **Operating conditions:**
0 °C–40 °C, 20 %–80 % relative air humidity (dry)

Note:

- The range of the handset under maximum conditions is 60 metres indoors and 300 metres outdoors. Please note it will probably be shortened when near concrete barriers, etc.

Getting Started

Setting up

Connections

■ Base unit

- ① Connect the AC adaptor to the unit by pressing the plug firmly.
- ② Connect the AC adaptor to the power outlet.
- ③ Connect the telephone line cord to the unit, then to the telephone line jack until you hear a click.
- ④ Fasten the cord by hooking it.
- ⑤ A DSL/ADSL filter (not supplied) is required if you have a DSL/ADSL service.

Note:

- Use only the supplied Panasonic AC adaptor.*1
- Use only the supplied telephone line cord.

*1 PNLV226CE: KX-TGK210BX/
KX-TGK220BX
PNLV226E: KX-TGK210UE

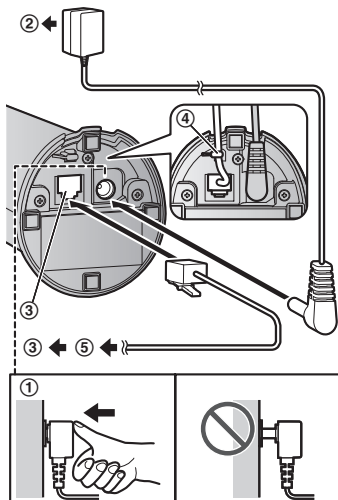

Battery installation/setting the handset cover

- USE ONLY rechargeable Ni-MH batteries AAA (R03) size (A).
- Do NOT use alkaline/manganese/Ni-Cd batteries.
- Confirm correct polarities (+, -).

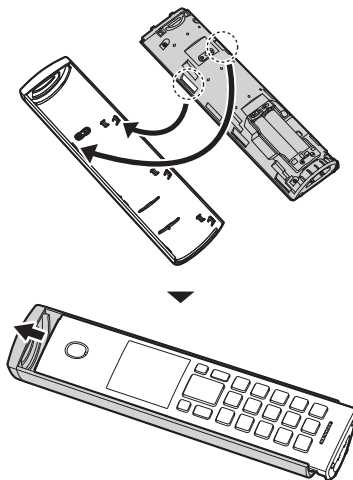
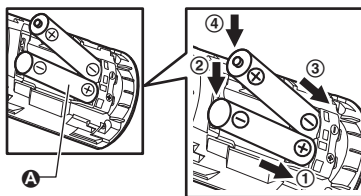

- Follow the directions on the display to set up the unit.

Removing the handset cover and battery

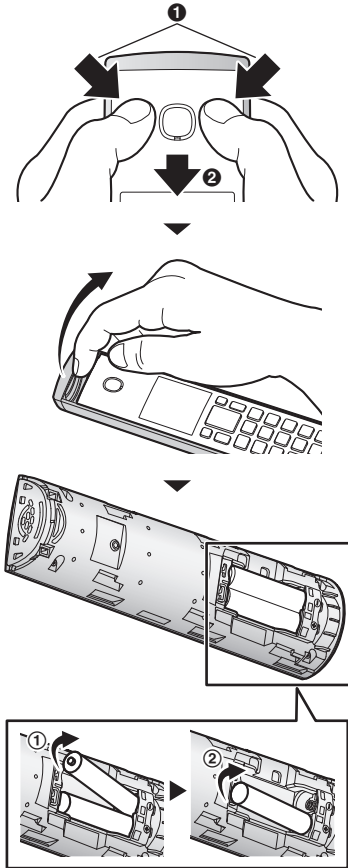

Battery charging

Charge for about 7 hours.

- When the handset is placed on the base unit, a beep is heard and the message indicator lights up about 5 seconds (A).

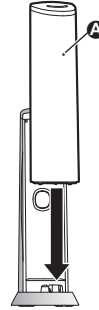

Note when setting up

Note for connections

- The AC adaptor must remain connected at all times. (It is normal for the adaptor to feel warm during use.)
- The AC adaptor should be connected to a vertically oriented or floor-mounted AC outlet. Do not connect the AC adaptor to a horizontally oriented AC outlet that faces the floor, such as an AC outlet installed on a ceiling or under a table, as the weight of the adaptor may cause it to become disconnected.

Power failure

- The unit cannot be used to make or receive calls during a power failure. We recommend connecting a corded-type telephone that does not use an AC adaptor to your telephone line.

Note for battery installation



- Use the supplied rechargeable batteries. For replacement, we recommend using the Panasonic rechargeable batteries noted on page 3, 6.

Getting Started

Note for battery charging

- It is normal for the handset to feel warm during charging.
- Clean the charge contacts of the handset, base unit, and charger with a soft and dry cloth once a month. Before cleaning the unit, disconnect from power outlets and any telephone line cords. Clean more often if the unit is exposed to grease, dust, or high humidity.

Battery level

Icon	Battery level
	Full
	Low
	Needs charging.

Ni-MH battery performance (supplied batteries)

Operation	Operating time
In continuous use	18 hours max.
Not in use (standby)	200 hours max.

Note:

- Actual battery performance depends on usage and ambient environment.

Controls

Base unit

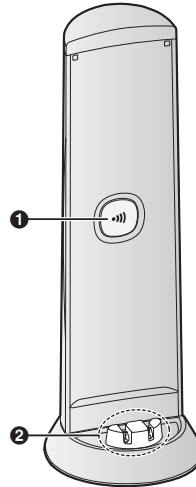

- 1 **[••)] (Locator)**
 - You can locate a misplaced handset by pressing [••)].
- 2 **Charge contacts**

Handset

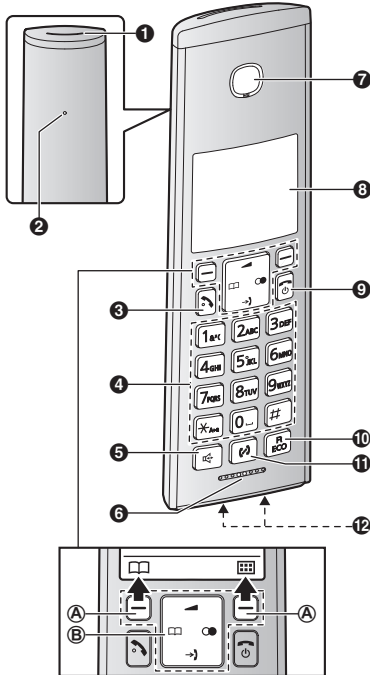

- 1 Speaker
- 2 Message indicator
- 3 (Talk)
- 4 Dial keypad
- 5 (Speakerphone)
- 6 Microphone
- 7 Receiver
- 8 Display
- 9 (Off/Power)
- 10 [R/ECO]
R: Recall/Flash
ECO: Eco mode shortcut key
- 11 [Intercom]
- 12 Charge contacts

Control type

A Soft keys

By pressing a soft key, you can select the feature shown directly above it on the display.

B Navigator key

Navigator keys functions as follows.

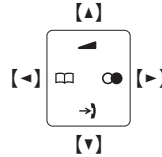











- [▲], [▼], [◀], or [▶]: Scroll through various lists and items.
- [▲] or [▼] (▲): Adjust the receiver or speaker volume while talking.
- [→] (Caller list): View the caller list.
- [☐] (Phonebook): View the phonebook entry.
- [●] (Redial): View the redial list.

Display icons

Handset display items

Item	Meaning
	Range status: The more bars visible, the closer the handset is to the base unit.
	Out of base unit range
	Security for phone calls is set to "Enhanced" ¹ (page 29)
	Paging, intercom mode
	Speakerphone is on. (page 15)
	The line is in use. <ul style="list-style-type: none"> ● When flashing slowly: The call is on hold. ● When flashing rapidly: An incoming call is now being received.
	Missed call ² (page 32)

Getting Started



Item	Meaning
	Eco mode is set to "Eco". (page 13)
	The LCD and key backlight is off. (page 23)
	<ul style="list-style-type: none"> When displayed next to the battery icon: Answering system is on.*¹ (page 34) When displayed with a number: New messages have been recorded.*¹ (page 35)
	"Greeting Only" is selected. Caller messages are not recorded.* ¹ (page 37)
	Battery level
	Alarm is on. (page 26)
	Privacy mode is on. (page 24)
	Ringer volume is off. (page 23)
	Do not disturb mode is on. (page 26)
	Nuisance call blocked.* ² (page 27)
	New voicemail message received.* ³ (page 38)
Line in use	Someone is using the line.
IN USE	Answering system is being used by another handset.* ¹

















*¹ KX-TGK220 series: page 3

*² Caller ID subscribers only

*³ Voicemail subscribers only

Handset soft key icons

Icon	Action
	Returns to the previous screen or outside call.
	Displays the menu.
OK	Accepts the current selection.

Icon	Action
	Makes a call. (page 15)
	Temporarily turns off the ringer for incoming calls. (page 15)
	Places a call on hold.
	Opens the phonebook.
	Allows you to edit phone numbers. (page 28)
	Adds new entry. (page 19)
	Displays the phonebook search menu.
	Turns the key lock feature off. (page 17)
	Stops alarm. (page 26)
	Snooze button on the alarm. (page 26)
	Selects entries or handsets. (page 13, 26)
	Stops recording or playback.* ¹
	Stores phone numbers. (page 18)
	Erases the selected item.
	Allows you to make an intercom call. (page 17)
C	Erases a number/character.
	Puts the call on mute.

*¹ KX-TGK220 series: page 3

Turning the power on/off

Press [] for about 2 seconds.

Language setting

Display language

1 []#1110

- 2 [↕]: Select your desired language. →
[OK] → [🗨️]

Date and time

- 1 [📠]#101
- 2 Enter the current date, month, and year.
→ [OK]
Example: 12 July, 2017
12 07 17
- 3 Enter the current hour and minute.
Example: 9:30
09 30
- You can select 24-hour or 12-hour clock format (“AM” or “PM”) by pressing [🕒].
- 4 [OK] → [🗨️]

Recording your greeting message

Available for:
KX-TGK220 series (page 3)

You can record your own greeting message instead of using a pre-recorded greeting message. See page 34 for details.

- 1 [📠]#302
- 2 [↕]: “Yes” → [OK]
- 3 Record a greeting message. → [■] → [🗨️]

Other settings

Message indicator

The message indicator is located on the back of the handset and informs you of the following status with its flashing.

Indicator	Status
Flashing rapidly	<ul style="list-style-type: none"> Incoming call or intercom call are now being received. (page 15, 17) An alarm sounds. (page 26)
Flashing slowly*1	<ul style="list-style-type: none"> There are new messages.*2 (page 35) There are missed calls. (page 32)

*1 To activate, setting of message indicator must be “On”. (page 13)

*2 KX-TGK220 series: page 3

Setting the message indicator

The message indicator for the following feature must be “On”.

- “New Message” *1 (Default: On)
 - “Missed Call” (Default: Off)
- *1 KX-TGK220 series: page 3

- 1 [📠]#278
- 2 [✓]
- “✓” is displayed next to the selected feature.
 - To cancel a selected feature, press [✓] again. “✓” disappears.
- 3 [OK] → [🗨️]

Note:

- If the message indicator flashes when the handset is not placed on the base unit, battery consumption is faster than usual.

Eco mode setting

You can select the desired eco mode setting by pressing [R/ECO].

The following settings are available for eco mode.

- “Eco”: Reduces the base unit transmission power by up to 90 % in standby mode. When this setting is selected, **ECO** is displayed on the handset display instead of **Y**.
- “Eco Off” (default setting): Turns off eco mode.

Getting Started

When this setting is selected, **ECO** is not displayed in the handset display.

Note:

- When there is another cordless phone in use nearby, the base unit transmission power may not be reduced.
- When eco mode is active, the range of the base unit is reduced in standby mode.
- If you set repeater mode to "on" (page 30):
 - Eco mode is disabled.
 - "Eco Mode" is not displayed in the display menu (page 23).

Dialling mode

If you cannot make calls, change this setting according to your telephone line service. The default setting is "Tone".

"Tone": For tone dial service.

"Pulse": For rotary/pulse dial service.

1 **[☰] # 1 2 0**

2 **[↕]**: Select the desired setting. → **[OK]**
→ **[🔄]**

Making/Answering Calls

Making calls

- 1 Lift the handset and dial the phone number.
 - To correct a digit, press [C].
- 2 Press [📞] to make the call.
 - To make the call using the speakerphone, press [📞].
- 3 When you finish talking, press [📞] or place the handset on the base unit or charger.

Note:

- To switch to the speaker, press [📞].
To switch back to the receiver, press [📞]/[📞].

Adjusting the receiver or speaker volume

Press [▲] or [▼] repeatedly while talking.

Making a call using the redial list

The last 10 phone numbers dialled are stored in the redial list (24 digits max. each).

- 1 [📞]
- 2 [↕]: Select the desired entry.
- 3 [📞]

Erasing a number in the redial list

- 1 [📞]
- 2 [↕]: Select the desired entry. → [X]
- 3 [↕]: "Yes" → [OK] → [📞]

Pause (for PBX/long distance service users)

A pause is sometimes required when making calls using a PBX or long distance service. When storing a calling card access number and/or PIN in the phonebook, a pause is also needed (page 19).

Example: If you need to dial the line access number "0" when making outside calls with a PBX:

- 1 [0] → [▲] (Pause)

- 2 Dial the phone number. → [📞]

Note:

- A 3 second pause is inserted each time [▲] (Pause) is pressed.

Answering calls

- 1 Lift the handset and press [📞] or [📞] when the unit rings.
- 2 When you finish talking, press [📞] or place the handset on the base unit or charger.

Any key answer: You can answer the call by pressing any dial key.

Auto talk: You can answer calls simply by lifting the handset (page 24).

Temporary handset ringer off: You can turn the ringer off temporarily by pressing [📞].

Adjusting the ringer volume

Press [▲] or [▼] repeatedly to select the desired volume while ringing.

Useful features during a call

Hold

- 1 Press [📞] during an outside call.
- 2 [↕]: "Hold" → [OK]
- 3 To release hold, press [📞].

Note:

- After holding for 10 minutes, the call is disconnected.

Mute

- 1 Press [📞] during a call.
- 2 To return to the call, press [📞].

Making/Answering Calls

Recall/flash

[R/ECO] allows you to use the special features of your host PBX such as transferring an extension call, or accessing optional telephone services.

Note:

- To change the recall/flash time, see page 24.

For call waiting or Call Waiting Caller ID service users

To use call waiting or Call Waiting Caller ID, you must first subscribe with your phone service provider.

This feature allows you to receive calls while you are already talking on the phone. If you receive a call while on the phone, you will hear a call waiting tone.

If you subscribe to both **Caller ID and Call Waiting with Caller ID services**, the 2nd caller's information is displayed on the unit that is in use after you hear the call waiting tone.

- 1 Press **[R/ECO]** to answer the 2nd call.
- 2 To switch between calls, press **[R/ECO]**.

Note:

- Please contact your phone service provider for details and availability of this service in your area.

Temporary tone dialling (for rotary/pulse service users)

Press **[X]** before entering access numbers which require tone dialling.

Handset equalizer

This feature clarifies the voice of the person you are talking to, producing a more natural-sounding voice that is easier to hear and understand.

- 1 Press **[EQ]** while talking.
- 2 **[↕]**: "Equalizer" → **[OK]**
- 3 **[↕]**: Select the desired setting.

- 4 Press **[OK]** to exit.

Note:

- Depending on the condition and quality of your telephone line, this feature may emphasise existing line noise. If it becomes difficult to hear, turn this feature off.
- This feature is not available while using the speakerphone.

Call share

You can join an existing outside call. To join the conversation, press **[↵]** when the other handset is on an outside call.

Note:

- To prevent other users from joining your conversations with outside callers, turn the privacy mode on (page 24).

Transferring calls, conference calls

Outside calls can be transferred or a conference call with an outside party can be made between handsets in the same radio cell.

- 1 During an outside call, press **[↵]**.
When 3 or more handsets are registered:
[↕]: Select the desired unit. → **[OK]**
- 2 Wait for the paged party to answer.
 - If the paged party does not answer, press **[↵]** to return to the outside call.
- 3 **To complete the transfer:**
Press **[↵]**.
To establish a conference call:
[EQ] → **[↕]**: "Conference" → **[OK]**
 - To leave the conference, press **[↵]**.
The other 2 parties can continue the conversation.
 - To put the outside call on hold: **[EQ]** → **[↕]**: "Hold" → **[OK]**
To resume the conference: **[EQ]** → **[↕]**: "Conference" → **[OK]**
 - To cancel the conference: **[EQ]** → **[↕]**: "Stop Conference" → **[OK]**
You can continue the conversation with the outside caller.

Intercom

Intercom calls can be made between handsets in the same radio cell.

Note:

- When paging the handset, the paged handset beeps for 1 minute.
- If you receive an outside call while talking on the intercom, the interrupt tone sounds. To finish intercom, press [📞]. To answer the call, press [📞].

Making an intercom call

- 1 [📞]
When 3 or more handsets are registered:
[📞]: Select the desired unit. → [OK]
- 2 When you finish talking, press [📞].

Answering an intercom call

- 1 Press [📞] to answer the page.
- 2 When you finish talking, press [📞].

Key lock

The handset can be locked so that no calls or settings can be made. Incoming calls can be answered, but all other functions are disabled while key lock is on.

To turn key lock on, press [🔒] for about 3 seconds.

- To turn key lock off, press [🔒-O] for about 3 seconds.

Note:

- Calls to emergency numbers cannot be made until key lock is turned off.

Phonebook

Phonebook

■ KX-TGK210 series: page 3

You can add 50 names (16 characters max.) and phone numbers (24 digits max.) to the phonebook.

■ KX-TGK220 series: page 3

You can add 120 names (16 characters max.) and phone numbers (24 digits max.) to the phonebook, and assign each phonebook entry to the desired category (page 18).

Important:

- All entries can be shared by any registered handset.

Adding phonebook entries

- 1 [] → []
- 2 [↕]: "New Entry" → [OK]
- 3 Enter the party's name. → [OK]
 - You can change the character entry mode by pressing [R/ECO] (page 38).
- 4 Enter the party's phone number. → [OK]
 - KX-TGK210 series: Go to step 6
- 5 [↕]: Select the desired category. → [OK]
- 6 [OK] → [📞]

Storing a redial list number to the phonebook

- 1 [📞]
- 2 [↕]: Select the desired entry. → [📞]
- 3 To store the name, continue from step 3, "Editing entries", page 19.

Storing caller information to the phonebook

- 1 [→]
- 2 [↕]: Select the desired entry. → []
- 3 [↕]: "Save Phonebook" → [OK]

- 4 To store the name, continue from step 3, "Editing entries", page 19.

Categories

Available for:

KX-TGK220 series (page 3)

Categories can help you find entries in the phonebook quickly and easily. You can change the names of categories ("Friends", "Family", etc.). By assigning different ringer tones for different categories of callers, you can identify who is calling (category ringer tone), if you have subscribed to Caller ID service.

Changing category names/setting category ringer tone

- 1 [] → []
- 2 [↕]: "Category" → [OK]
- 3 [↕]: Select the desired category. → [OK]
- 4 **To change category names**
[↕]: "Category Name" → [OK] → Edit the name (10 characters max.). → [OK]
To set category ringer tone
[↕]: Select the current setting of the category ringer tone. → [OK] → [↕]: Select the desired ringer tone. → [OK]
- 5 [📞]

Finding and calling from a phonebook entry

- 1 []
- 2 **To scroll through all entries**
[↕]: Select the desired entry.
To search by first character
 - ① Press the dial key ([0] to [9], or [#]) which contains the character you are searching for (page 38).
 - ② [↕]: Scroll through the phonebook if necessary.**To search by category*1**
 - ① [📞] → [↕]: "Category" → [OK]

- ② [↕]: Select the desired category. → [OK]
- ③ [↕]: Scroll through the phonebook if necessary.
- 3 [↶]
- *1 KX-TGK220 series: page 3

Editing entries

- 1 Find the desired entry (page 18). → [⏏]
- 2 [↕]: "Edit" → [OK]
- 3 Edit the name if necessary. → [OK]
- 4 Edit the phone number if necessary. → [OK]
 - KX-TGK210 series: Go to step 6
- 5 [↕]: Select the desired category (page 18). → [OK]
- 6 [OK] → [📞]

Erasing entries

Erasing an entry

- 1 Find the desired entry (page 18). → [⏏]
- 2 [↕]: "Erase" → [OK]
- 3 [↕]: "Yes" → [OK] → [📞]

Erasing all entries

- 1 [⏏] → [⏏]
- 2 [↕]: "Erase All" → [OK]
- 3 [↕]: "Yes" → [OK]
- 4 [↕]: "Yes" → [OK] → [📞]

Chain dial

This feature allows you to dial phone numbers in the phonebook while you are on a call. This feature can be used, for example, to dial a calling card access number or bank account PIN that you have stored in the phonebook, without having to dial manually.

- 1 During an outside call, press [⏏].
- 2 [↕]: Select the desired entry.

- 3 Press [↶] (right soft key) to dial the number.

Note:

- When storing a calling card access number and your PIN in the phonebook as one phonebook entry, press [⏏] (Pause) to add pauses after the number and PIN as necessary (page 15).
- If you have rotary/pulse service, you need to press [⏏] before pressing [⏏] in step 1 to change the dialling mode temporarily to tone. When adding entries to the phonebook, we recommend adding [⏏] to the beginning of phone numbers you wish to chain dial (page 18).

Speed dial

You can assign 1 phone number to each of the dial keys ([1] to [9]) on the handset.

Adding phone numbers to speed dial keys

■ By entering phone numbers:

- 1 Press and hold the desired speed dial key ([1] to [9]). → [⏏↶]
- 2 [↕]: "Manual" → [OK]
- 3 Enter the party's name (16 characters max.). → [OK]
- 4 Enter the party's phone number (24 digits max.). → [OK] 2 times → [📞]

■ From the phonebook:

- 1 Press and hold the desired speed dial key ([1] to [9]). → [⏏↶]
- 2 [↕]: "Phonebook" → [OK]
- 3 [↕]: Select the desired entry. → [OK] → [📞]

Note:

- If you edit a phonebook entry which is assigned to a speed dial key, the edited entry does not transfer to the speed dial key.

Phonebook

Editing an entry

- 1 Press and hold the desired speed dial key (1 to 9). → [☐☐☐]
- 2 [↕]: “Edit” → [OK]
- 3 Edit the name if necessary. → [OK]
- 4 Edit the phone number if necessary. → [OK] 2 times → [📞]

Erasing an entry

- 1 Press and hold the desired speed dial key (1 to 9). → [☐☐☐]
- 2 [↕]: “Erase” → [OK]
- 3 [↕]: “Yes” → [OK] → [📞]

Viewing an entry/Making a call

- 1 Press and hold the desired speed dial key (1 to 9).
- 2 To make a call, press [📞].





Menu list

To access the features, there are 2 methods.

■ Scrolling through the display menus

- 1 
- 2 Press [**▼**], [**▲**], [**▶**], or [**◀**] to select the desired main menu. → [**OK**]
- 3 Press [**▼**] or [**▲**] to select the desired item from the next sub-menus. → [**OK**]
- 4 Press [**▼**] or [**▲**] to select the desired setting. → [**OK**]

■ Using the direct command code

- 1  → Enter the desired code.
Example: Press    .
- 2 Select the desired setting. → [**OK**]

Note:

- To exit the operation, press [**⏻**].
- In the following table, < > indicates the default settings.
- In the following table,  indicates the reference page number.
- Display menu order and sub-menu may vary depending on your model.

Display the menu tree and direct command code table

Main menu:  "Answer System"^{*1}

Sub-menu 1	Sub-menu 2	Settings	Code	
Play New Message	–	–	#323	35
Play All Message	–	–	#324	35
Erase All Message ^{*2}	–	–	#325	35
Greeting	Record Greeting ^{*2}	–	#302	34
	Play Greeting	–	#303	35
	Default ^{*2} (Reset to pre-recorded greeting)	–	#304	34
Settings	Number of Rings ^{*2}	Auto 2-7 Rings <4 Rings>	#211	37
	Recording Time ^{*2}	<3 Minutes> 1 Minute Greeting Only ^{*3}	#305	37
	Remote Code ^{*2}	–	#306	35
	Call Screening	<On> Off	#310	36
Answer On ^{*2}	–	–	#327	34

Programming

Sub-menu 1	Sub-menu 2	Settings	Code	
Answer Off ²	-	-	#328	34

Main menu:  "Time Settings"

Sub-menu 1	Sub-menu 2	Settings	Code	
Set Date/Time ²	-	-	#101	13
Memo Alarm	Alarm1-3	<Off> Once Daily Weekly	#720	26
Time Adjustment ^{2, *4}	-	Caller ID <Manual>	#226	-

Main menu:  "Caller List"

Operation	Code	
Viewing the caller list.	#213	32

Main menu:  "Ringer Setup"

Sub-menu 1	Sub-menu 2	Settings	Code	
Ringer Volume	-	Off-6 <6>	#160	-
Ringtone ⁵	-	<Ringtone 1>	#161	-
Do Not Disturb Mode	On/Off	On <Off>	#238	26
	Start/End	<23:00/06:00>	#237	27
	Ring Delay	30 sec. <60 sec.> 90 sec. 120 sec. No Ringing	#239	27
	Select Category ^{*1}	Category 1-9	#241	27
First Ring ^{2, *6}	-	<On> Off	#173	-

Programming

Main menu:  "Initial Setup"

Sub-menu 1	Sub-menu 2	Settings	Code	
Ringer Setup	Ringer Volume	Off-6 <6>	#160	-
	Ringtone ^{*5}	<Ringtone 1>	#161	-
	Do Not Disturb Mode - On/Off	On <Off>	#238	26
	Do Not Disturb Mode - Start/End	<23:00/06:00>	#237	27
	Do Not Disturb Mode - Ring Delay	30 sec. <60 sec.> 90 sec. 120 sec. No Ringing	#239	27
	Do Not Disturb Mode - Select Category ^{*1}	Category 1-9	#241	27
	First Ring ^{*2, *6}	<On> Off	#173	-
Time Settings	Set Date/Time ^{*2}	-	#101	13
	Memo Alarm - Alarm1-3	<Off> Once Daily Weekly	#720	26
	Time Adjustment ^{*2, *4}	Caller ID <Manual>	#226	-
Nuisance Call Block ^{*2}	Single Number	-	#217	27
	Range of Numbers	-		
	Withheld	On <Off>	#240	28
Speed Dial	-	-	#261	19
Eco Mode ^{*2, *7}	-	<Off> Eco	#725	13
Security ^{*1, *2, *7}	-	<Normal> Enhanced	#729	29
Record Greeting ^{*1, *2}	-	-	#302	34
Display Setup	LCD & Key Backlight	<On> Off	#276	-
	Contrast (Display contrast)	Level 1-4 <2>	#145	-
	Handset Name	-	#104	28
	Display Name	On <Off>	#105	28

Programming

Sub-menu 1	Sub-menu 2	Settings	Code	
Message Indicator	–	–	#278	13
Keytones	–	<On> Off	#165	–
Area Code ^{*2}	–	–	#255	28
Call Restrict ^{*2}	–	–	#256	28
Auto Talk ^{*8}	–	On <Off>	#200	15
Line Setup	Dial Mode ^{*2}	<Tone> Pulse	#120	14
	Recall/Flash ^{*2, *9}	80 msec. 90 msec. 100 msec. 110 msec. 160 msec. 200 msec. 250 msec. 300 msec. 400 msec. <600 msec.> 700 msec. 900 msec.	#121	16
Privacy Mode ^{*2, *10}	–	On <Off>	#194	–
Base Unit PIN ^{*2}	–	<0000>	#132	29
Repeater Mode ^{*2}	–	On <Off>	#138	30
Register	Register Handset	–	#130	30
	Cancel Register ^{*3}	–	#131	30
Select Base	–	<Auto>	#137	30
Cancel Base ^{*3}	–	–	#139	30
Language	Display	<English>	#110	12

Main menu:  "Nuisance Call Block"^{*2}

Sub-menu 1	Sub-menu 2	Settings	Code	
Single Number	–	–	#217	27
Range of Numbers	–	–		
Withheld	–	On <Off>	#240	28

Programming

Main menu: ■■ "Speed Dial"*11

Operation	Code	
Viewing the speed dial entry.	#261	19

- *1 KX-TGK220 series: page 3
- *2 If you program these settings using one of the handsets, you do not need to program the same item using another handset.
- *3 This menu is not displayed when scrolling through the display menus. It is only available in direct command code.
- *4 This feature allows the unit to automatically adjust the date and time each time caller information including date and time is received.
To turn this feature on, select "Caller ID". To turn this feature off, select "Manual". (Caller ID subscribers only)
To use this feature, set the date and time first (page 13).
- *5 The preset melodies in this product ("Ringtone 3" - "Ringtone 40") are used with permission of © 2012 - 2017 Copyrights Vision Inc.
- *6 If you do not want the unit to ring before the caller information is received, set to "OFF". (Caller ID subscribers only)
You can only remove the first ring if the unit rings 2 times or more by default, which depends on your phone service provider.
- *7 This menu is not displayed when repeater mode is set to "on".
- *8 If you subscribe to a Caller ID service and want to view the caller's information after lifting up the handset to answer a call, turn off this feature.
- *9 The recall/flash time depends on your telephone exchange or host PBX. Contact your PBX supplier if necessary.
- *10 To prevent other users from joining your conversations with outside callers, turn this feature on.
- *11 KX-TGK210 series: page 3

Programming

Alarm

An alarm sounds at the set time for 1 minute and is repeated 5 times at 5 minute intervals (snooze function). A text memo can also be displayed for the alarm. A total of 3 separate alarm times can be programmed for each handset. You can set one of 3 different alarm options (once, daily, or weekly) for each alarm time.

Important:

- Make sure the unit's date and time setting is correct (page 13).

- 1 **[☰]#720**
- 2 **[↕]**: Select the desired alarm. → **[OK]**
- 3 **[↕]**: Select the desired alarm option. → **[OK]**

"Off"
Turns alarm off. Go to step 9.
"Once"
An alarm sounds once at the set time.
"Daily"
An alarm sounds daily at the set time. Go to step 5.
"Weekly"
Alarm sounds weekly at the set time(s).

- 4 Proceed with the operation according to your selection in step 3.
 - **Once:**
Enter the desired date and month. → **[OK]**
 - **Weekly:**
[↕]: Select the desired day of the week and press **[✓]**. → **[OK]**
- 5 Set the desired time. → **[OK]**
- 6 Enter a text memo (10 characters max.). → **[OK]**
- 7 **[↕]**: Select the desired alarm tone. → **[OK]**
 - We recommend selecting a different ringer tone from the one used for outside calls.

- 8 **[↕]**: Select the desired snooze setting. → **[OK]**

- 9 **[OK]** → **[🔔]**

Note:

- Press **[🔔]** to stop the alarm completely.
- When the handset is in use, the alarm will not sound until the handset is in standby mode.
- Press any dial key or **[📞]** to stop the sound but keep the snooze function activated.
- If you want to make an outside call when the snooze function is activated, please stop the snooze function before making the call.

Do not disturb mode

Do not disturb mode allows you to select a period of time during which the handset will not ring for outside calls. This feature is useful for time periods when you do not want to be disturbed, for example, while sleeping. Do not disturb mode can be set for each handset. Using the phonebook's category feature (page 18), you can also select categories of callers whose calls override do not disturb mode and ring the handset (Caller ID subscribers only). (KX-TGK220 series: page 3)

Important:

- Make sure the unit's date and time setting is correct (page 13).
- If you have set the alarm, the alarm sounds even if do not disturb mode is turned on.

Turning do not disturb mode on/off

- 1 **[☰]#238**
- 2 **[↕]**: Select the desired setting. → **[OK]**
 - If you select "Off", press **[🔔]** to exit.
- 3 Enter the desired hour and minute you wish to start this feature. → **[OK]**
- 4 Enter the desired hour and minute you wish to end this feature. → **[OK]** → **[🔔]**

Changing the start and end time

- 1 **[☐]#237**
- 2 Continue from step 3, "Turning do not disturb mode on/off", page 26.

Setting the ring delay

This setting allows the handset to ring during do not disturb mode if the caller waits long enough. After the selected amount of time passes, the handset rings. If you select "**No Ringing**", the handset never rings during do not disturb mode.

- 1 **[☐]#239**
- 2 **[↕]**: Select the desired setting. → **[OK]**
→ **[📞]**

Note:

- When the answering system answers the call, this feature does not work.
(KX-TGK220 series: page 3)

Selecting categories to bypass do not disturb mode

Available for:
KX-TGK220 series (page 3)

- 1 **[☐]#241**
- 2 **[↕]**: Select the desired categories. → **[✓]**
 - "✓" is displayed next to the selected category numbers.
 - To cancel the selected category:
[↕]: Select the category. → Press **[✓]** again. "✓" disappears.
- 3 **[OK]** → **[📞]**

Nuisance call block

This feature blocks calls from unwanted callers (Caller ID subscribers only). The following items are available when storing phone numbers in the call block list.

- "**Single Number**": The unit blocks calls from specific phone numbers.

- "**Range of Numbers**": The unit blocks calls that begin with a number stored in the call block list, such as a toll-free phone number prefix or certain area codes.

Single phone numbers and ranges of numbers can be stored in the call block list:

- up to 30 items in total. (KX-TGK210 series: page 3)
- up to 50 items in total. (KX-TGK220 series: page 3)

You can also set the unit to block calls that have no phone number.

When a call is received, the unit does not ring while the caller is being identified. If the caller's phone number matches an entry in the call block list, the unit emits no sound to the caller, and disconnects the call.

Important:

- Blocked calls are logged in the caller list.

Storing unwanted callers

Storing a single phone number

Important:

- You must include the area code when storing phone numbers in the call block list.

■ From the caller list:

- 1 **[→]**
- 2 **[↕]**: Select the entry to be blocked. → **[☐]**
- 3 **[↕]**: "**Save Call Block**" → **[OK]**
- 4 **[↕]**: "**Yes**" → **[OK]** → **[📞]**

■ By entering phone numbers:

- 1 **[☐]#217**
- 2 **[↕]**: "**Single Number**" → **[OK]**
- 3 **[☐]** → **[↕]**: "**Add**" → **[OK]**
- 4 Enter the phone number (24 digits max.).
 - To erase a digit, press **[C]**.
- 5 **[OK]** → **[📞]**

Storing a range of numbers

- 1 **[☐]#217**
- 2 **[↕]**: "**Range of Numbers**" → **[OK]**
- 3 **[☐]** → **[↕]**: "**Add**" → **[OK]**

Programming

- 4 Enter the desired number (2-8 digits).
 - To erase a digit, press [C].
- 5 [OK] → [📞]

Blocking incoming calls that have no phone number

You can block calls when no phone number is provided, such as private callers.

- 1 [📞]#240
- 2 [↕]: Select the desired setting. → [OK]
- 3 [📞]

Viewing/editing/erasing call block numbers

- 1 [📞]#217
- 2 [↕]: "Single Number" or "Range of Numbers" → [OK]
- 3 [↕]: Select the desired entry.
 - To exit, press [📞].
- 4 To edit a number:
[📞] → Edit the number. → [OK] → [📞]
To erase a number:
[X] → [↕]: "Yes" → [OK] → [📞]

Note:

- When editing, press the desired dial key to add digits and press [C] to erase digits.

Erasing all call block numbers

- 1 [📞]#217
- 2 [↕]: "Single Number" or "Range of Numbers" → [OK]
- 3 [📞] → [↕]: "Erase All" → [OK]
- 4 [↕]: "Yes" → [OK]
- 5 [↕]: "Yes" → [OK] → [📞]

Other programming

Changing the handset name

The default handset name is "Handset 1" to "Handset 6". You can customise the name of each handset ("Bob", "Kitchen", etc.). This is useful when you make intercom calls between handsets. To display the handset name in standby mode, turn on the handset name display feature (page 28).

- 1 [📞]#104
- 2 Enter the desired name (10 characters max.). → [OK] → [📞]

Displaying the handset name

You can select whether or not the handset name is displayed in standby mode. The default setting is "off".

- 1 [📞]#105
- 2 [↕]: Select the desired setting. → [OK] → [📞]

Storing an area code to be deleted automatically

In some situations, phone numbers stored automatically in the caller list (page 32) will include area codes. If you do not want to dial the area code when making calls from the caller list, you can store the area code which you want the unit to delete automatically.

Example: You have stored the area code "123". If you make a call from the caller list to the phone number "123-456-7890", the unit dials "456-7890".

- 1 [📞]#255
- 2 Enter an area code (5 digits max.). → [OK] → [📞]

Call restriction

You can restrict selected handsets from dialling certain numbers. You can assign up to 6 phone numbers to be restricted, and select

which handsets are to be restricted. Storing area codes here prevents the restricted handsets from dialling any phone number in that area code.

- 1 **[☰]#256**
- 2 Enter the base unit PIN (default: "0000").
 - If you forget your PIN, contact an authorised service centre.
- 3 **[↕]**: Select the handsets to be restricted. → **[✓]**
 - "✓" is displayed next to the selected handset numbers.
 - To cancel the selected handsets: **[↕]**: Select the handset. → Press **[✓]** again. "✓" disappears.
- 4 **[OK]**
- 5 **[↕]**: Select a memory location. → **[OK]**
- 6 Enter the phone number or area code to be restricted (8 digits max.). → **[OK]** → **[☎]**

Enhancing security for phone calls

Available for:
KX-TGK220 series (page 3)

You can increase the security of phone conversations by setting this feature to "Enhanced". When "Enhanced" is selected, **☒** is displayed. The default setting is "Normal".

- 1 **[☰]#729**
- 2 **[↕]**: Selected the desired setting. → **[OK]**
- 3 **[☎]**

Note:

- If you set repeater mode to "on" (page 30):
 - Security is set to "Normal" and **☒** is displayed.
 - "Security" is not displayed in the display menu (page 23).
- When enhanced security is enabled, sound may cut in and out during conversations.

Changing the base unit PIN

Important:

- If you change the PIN (Personal Identification Number), please make note of your new PIN. The unit will not reveal the PIN to you. If you forget your PIN, contact an authorised service centre.

- 1 **[☰]#132**
- 2 Enter the current 4-digit base unit PIN (default: "0000").
- 3 Enter the new 4-digit base unit PIN. → **[OK]**
- 4 **[↕]**: "yes" → **[OK]** → **[☎]**

Registering a unit

Operating additional units

Additional handsets

Up to 6 handsets can be registered to the base unit.

Important:

- The additional handset model recommended for use with this unit is noted on page 4. If another handset model is used, certain operations may not be available.

Additional base units

Handsets can be registered to up to 4 base units, allowing you to add additional base units and extend the area in which your handset(s) can be used. If a handset moves out of range of its base unit when "Auto" is selected on base unit (page 30), it looks for another base unit to make or receive calls. A base unit and the handsets it communicates with is called a "radio cell".

Note:

- Calls are disconnected when the handset moves from one radio cell to another.

Programming

Registering a handset to a base unit

The supplied handset and base unit are pre-registered. If for some reason the handset is not registered to the base unit (for example, **Y** is displayed even when the handset is near the base unit), re-register the handset.

- 1 Handset:**
[**☎**]#130
- 2 [**↕**]:** Select a base unit number. → [**OK**]
 - This number is used by the handset as a reference only.
- 3 Base unit:**
Press and hold [**📶**] for about 5 seconds.
 - If all registered handsets start ringing, press [**📶**] again to stop, then repeat this step.
- 4 Handset:**
[**OK**] → Wait until “Base PIN” is displayed. → Enter the base unit PIN (default: “0000”). → [**OK**]
 - If you forget your PIN, contact an authorised service centre.

Selecting a base unit

When “Auto” is selected, the handset automatically uses any available base unit it is registered to. When a specific base unit is selected, the handset makes and receives calls using that base unit only. If the handset is out of range of that base unit, no calls can be made.

- 1 [**☎**]#137**
- 2 [**↕**]:** Select the desired base unit number, or “Auto”. → [**OK**]

Important:

- When viewing the phonebook, caller list, etc., only the entries that are stored in the base unit that the handset is currently connected to are displayed.

Deregistering a handset

A handset can cancel its own registration to the base unit, or other handsets registered to the same base unit. This allows the handset to end its wireless connection with the system.

- 1 [**☎**]#131**
 - All handsets registered to the base unit are displayed.
- 2 [**↕**]:** Select the handset you want to cancel. → [**OK**]
- 3 [**↕**]:** “Yes” → [**OK**] → [**📶**]

Cancelling a base unit

A handset can cancel a base unit that it is registered to. This allows the base unit to end its wireless connection with the system.

- 1 [**☎**]#139**
- 2 [**↕**]:** Select the base unit you want to cancel. → [**OK**]
- 3 [**↕**]:** “Yes” → [**OK**] → [**📶**]

Increasing the range of the base unit

You can increase the signal range of the base unit by using a DECT repeater. Please use only the Panasonic DECT repeater noted on page 3. Contact your Panasonic dealer for details.

Important:

- Before registering the repeater to this base unit, you must turn the repeater mode on.
- Do not use more than one repeater at a time.

Setting the repeater mode

- 1 [**☎**]#138**
- 2 [**↕**]:** Select the desired setting. → [**OK**] → [**📶**]

Registering the DECT repeater (KX-A405/KX-A406) to the base unit

Note:

- Please use a repeater that has not yet been registered to another unit. If the repeater is registered to another unit, deregister it first, referring to the Installation Guide for the DECT repeater.



Programming

- 1 Base unit:**
Press and hold **[••••]** for about 5 seconds.
- 2 DECT repeater:**
Connect the AC adaptor, then wait until the **(i)** indicator and **Y** indicator light green.
- 3 Base unit:**
To exit the registration mode, press **[••••]**.

Caller ID Service

Using Caller ID service

Important:

- This unit is Caller ID compatible. To use Caller ID features, you must subscribe to a Caller ID service. Contact your phone service provider for details.

Caller ID features

When an outside call is being received, the caller information is displayed.

Caller information for the last 50 callers is logged in the caller list from the most recent call to the oldest.

- If the unit cannot receive caller information, the following is displayed:
 - “**Out of Area**”: The caller dials from an area which does not provide a Caller ID service.
 - “**Private Caller**”: The caller requests not to send caller information.
- If the unit is connected to a PBX system, caller information may not be properly received. Contact your PBX supplier.

Missed calls

If a call is not answered, the unit treats it as a missed call and **↔** is displayed. This lets you know if you should view the caller list to see who called while you were away.

Even if only one missed call in the caller list is viewed (page 32), **↔** disappears from the display. When you receive another new call, **↔** is displayed again.

Note:

- Even when there are unviewed missed calls, **↔** disappears from the standby display if the following operation is performed by one of the registered handsets:
 - Being replaced on the base unit or charger.
 - Pressing [**⏏**].

Phonebook name display

When caller information is received and it matches a phone number stored in the

phonebook, the stored name in the phonebook is displayed and logged in the caller list.

Caller list

Important:

- Make sure the unit's date and time setting is correct (page 13).

Viewing the caller list and calling back

- 1 [**↔**]
- 2 Press [**▼**] to search for the most recent call, or press [**▲**] to search from the oldest call.
- 3 To call back, press [**↶**].
To exit, press [**⏏**].

Note:

- If **▶** is displayed in step 2, not all of the information is shown. To see the remaining information, press [**▶**]. To return to the previous screen, press [**◀**].
- If the entry has already been viewed or answered, “**✓**” is displayed.
- If you do not want to dial the area code when making calls from the caller list, you can store the area code which you want the unit to delete automatically (page 28).

Editing a caller's phone number

- 1 [**↔**]
- 2 [**↕**]: Select the desired entry. → [**⏏**]
- 3 [**↕**]: “**Edit & Call**” → [**OK**]
- 4 Edit the number.
- 5 [**↶**]

Erasing selected caller information

- 1 [**↔**]
- 2 [**↕**]: Select the desired entry.

Caller ID Service

3 [X] → [↕]: “Yes” → [OK] → [📞]

Erasing all caller information

1 [→]

2 [X] → [↕]: “Yes” → [OK] → [📞]

Answering System

Answering system

Available for:
KX-TGK220 series (page 3)

The answering system can answer and record calls for you when you are unavailable to answer the phone.

You can also set the unit to play a greeting message but not to record caller messages by selecting "**Greeting Only**" as the recording time setting (page 37).

Important:

- Make sure the unit's date and time setting is correct (page 13).

Memory capacity (including your greeting message)

The total recording capacity is about 18 minutes. A maximum of 64 messages can be recorded.

Note:

- When message memory becomes full:
 - "**Messages Full**" is shown on the handset display.
 -  and the total number of new messages are not displayed on the handset even if the answering system is turned on.
 - If you use the pre-recorded greeting message, the unit automatically switches to another pre-recorded greeting message asking callers to call again later.
 - If you recorded your own greeting message, the same message is still announced to callers even though their messages are not recorded.

Turning the answering system on/off

The answering system is preset to on.

- 1 **To turn on:**
    

To turn off:

- 2     

Note:

- When the answering system is turned on,  is displayed on the handset.









Greeting message

When the unit answers a call, a greeting message is played to callers.

You can use either:

- your own greeting message
- a pre-recorded greeting message

Recording your greeting message

- 1     
- 2 : "Yes" → 
- 3 After a beep sounds, hold the handset about 20 cm away and speak clearly into the microphone (2 minutes max.).
- 4 Press  to stop recording. → 





Using a pre-recorded greeting message

The unit provides 2 pre-recorded greeting messages:

- If you erase or do not record your own greeting message, the unit plays a pre-recorded greeting asking callers to leave a message.
- If the message recording time (page 37) is set to "**Greeting Only**", callers' messages are not recorded and the unit plays a different pre-recorded greeting message asking callers to call again.

Resetting to a pre-recorded greeting message

Use this procedure to erase your greeting message and use a pre-recorded one.

- 1     
- 2  → 

Playing back the greeting message

- 1 **[*][#][3][0][3]**
- 2 **[📞]**

Listening to messages

When new messages have been recorded, **[📞]** is displayed on the handset with the total number of new messages.

- 1 **To listen to new messages:**
[*][#][3][2][3]
To listen to all messages:
[*][#][3][2][4]
- 2 When finished, press **[📞]**.

Note:

- To switch to the receiver, press **[📞]**.

Operating the answering system

[*][#] → [📞] → [OK]

Key	Operation
[▲] or [▼]	Adjust the receiver or speaker volume (during playback)
[1] or [◀]	Repeat message (during playback)*1
[2] or [▶]	Skip message (during playback)
[3]	Enter the "Settings" menu
[4]	Play new messages
[5]	Play all messages
[6]	Play greeting message
[7][6]	Record greeting message
[8]	Turn answering system on
[*][#]	Pause message*2
[9] or [■]	Stop recording Stop playback
[0]	Turn answering system off
[*][4] *3	Erase currently playing message

Key	Operation
[*][5]	Erase all messages
[*][6]	Reset to a pre-recorded greeting message

- *1 If pressed within the first 5 seconds of a message, the previous message is played.
- *2 To resume playback:
[▶]: "Play" → **[OK]**
- *3 You can also erase as follows:
[*][#] → **[▶]**: "Erase" → **[OK]** → **[▶]**: "Yes" → **[OK]**

Calling back (Caller ID subscribers only)

- 1 Press **[*][#]** during playback.
- 2 **[▶]**: "Call Back" → **[OK]**
- **Editing the number before calling back**
 - 1 Press **[*][#]** during playback.
 - 2 **[▶]**: "Edit & Call" → **[OK]**
 - 3 Edit the number. → **[📞]**

Erasing all messages

- 1 **[*][#][3][2][5]**
- 2 **[▶]**: "Yes" → **[OK]** → **[📞]**

Remote operation

Using a touch-tone phone, you can call your phone number from outside and access the unit to listen to messages or change answering system settings. The unit's voice guidance prompts you to press certain dial keys to perform different operations.

Remote access code

A 3-digit remote access code must be entered when operating the answering system remotely. This code prevents unauthorised parties from listening to your messages remotely.

Answering System

Important:

- In order to operate the answering system remotely, you must first set a remote access code.
- 1 **[*][*][*][#][3][0][6]**
 - 2 To turn on remote operation, enter the desired 3-digit remote access code.
 - 3 **[OK] → [📞]**

Deactivating remote operation

Press **[*]** in step 2 on “Remote access code”, page 35.

- The entered remote access code is deleted.

Using the answering system remotely

- 1 Dial your phone number from a touch-tone phone.
- 2 After the greeting message starts, enter your remote access code.
- 3 Follow the voice guidance prompts as necessary or control the unit using remote commands (page 36).
- 4 When finished, hang up.

Voice guidance

During remote operation, the unit's voice guidance starts and prompts you to press **[1]** to perform a specific operation, or press **[2]** to listen to more available operations.

Note:

- If you do not press any dial keys within 10 seconds after a voice guidance prompt, the unit disconnects your call.

Remote commands

You can press dial keys to access certain answering system functions without waiting for the voice guidance to prompt you.

Key	Operation
[1]	Repeat message (during playback)*1

Key	Operation
[2]	Skip message (during playback)
[4]	Play new messages
[5]	Play all messages
[6]	Play greeting message
[7]	Record greeting message
[9]	Stop recording Stop playback
[0]	Turn answering system off
[*][4]	Erase currently playing message
[*][5]	Erase all messages
[*][6]	Reset to a pre-recorded greeting message (during greeting message playback)
[*][#]	End remote operation (or hang up)

*1 If pressed within the first 5 seconds of a message, the previous message is played.

Turning on the answering system remotely

- 1 Dial your phone number from a touch-tone phone.
- 2 Let the phone ring 15 times.
 - A long beep is heard.
- 3 Enter your remote access code within 10 seconds after the long beep.
 - The greeting message is played back.
 - You can either hang up, or enter your remote access code again and begin remote operation (page 35).

Answering system settings

Call screening

While a caller is leaving a message, you can listen to the call through the handset's speaker. To adjust the speaker volume, press **[▲]** or **[▼]** repeatedly. You can answer the call

Answering System

by pressing [📞] on the handset. Call screening can be set for each handset. The default setting is “on”.

- 1 [📞]#310
- 2 [↕]: Select the desired setting. → [OK]
→ [📞]

Number of rings before the unit answers a call

You can change the number of times the phone rings “**Number of Rings**” before the unit answers a call. You can select 2 to 7 rings, or “**Auto**”.

The default setting is “**4 Rings**”.

“**Auto**”: The unit’s answering system answers at the end of the 2nd ring when new messages have been recorded, or at the end of the 5th ring when there are no new messages. If you call your phone from outside to listen to new messages (page 36), you know that there are no new messages when the phone rings for the 3rd time. You can then hang up without being charged for the call.

- 1 [📞]#211
- 2 [↕]: Select the desired setting. → [OK]
→ [📞]

Caller’s recording time

You can change the maximum message recording time allowed for each caller. The default setting is “**3 Minutes**”.

- 1 [📞]#305
- 2 [↕]: Select the desired setting. → [OK]
→ [📞]

Selecting “Greeting Only”

You can select “**Greeting Only**” which sets the unit to announce a greeting message to callers but not record messages.

Select “**Greeting Only**” in step 2 on “**Caller’s recording time**”, page 37.

Note:

- When you select “**Greeting Only**”:

- If you do not record your own message, the unit will play the pre-recorded greeting-only message asking callers to call again later.
- If you use your own message, record the greeting-only message asking callers to call again later (page 34).

Useful Information

Voicemail service

In addition to your unit's answering system you may also have voicemail service from your phone service provider. Voicemail is an answering service that may be offered by your phone service provider. This service can also record calls when you are unavailable to answer the phone or when your line is busy. Messages are recorded on the phone company system and not on the unit's answering system.

- To use the voicemail service rather than the unit's answering system, turn off the answering system (page 34).



If you have unit's answering system set to on and also the voicemail enabled, the system with least amount of rings will record the message first.

Example:

If the unit's answering system is set to 4 rings (page 37) and the voicemail answering system provided by your phone company is set to 6 rings (call your service provider), the unit's answering system will record the incoming call first.







When you have new messages,  is displayed on the handset if message indication service is available. Please contact your phone service provider for details of this service.

Important:

- If  still remains on the display even after you have listened to new messages, turn it off by pressing and holding  for 2 seconds.

Character entry



The dial keys are used to enter characters and numbers. Each dial key has multiple characters assigned to it. The characters that can be entered depend on the character entry mode (page 38).

- Press  or  to move the cursor left or right.
- Press dial keys to enter characters and numbers.
- Press  to erase the character or number highlighted by the cursor. Press and hold  to erase all characters or numbers.
- Press  (A→a) to switch between uppercase and lowercase.
- To enter another character located on the same dial key, press  to move the cursor to the next space, then press the appropriate dial key.
- If you do not press any dial key within 2 seconds after entering a character, the character is fixed and the cursor moves to the next space.

Character entry modes

The available character entry modes are Alphabet (ABC), Numeric (0-9), Greek (ΑΒΓ), Extended 1 (ĂĂĂ), Extended 2 (ŠŠŠ), and Cyrillic (АБВ). When in these entry modes except Numeric, you can select which character is entered by pressing a dial key repeatedly.

When the unit displays the character entry screen:

 → : Select a character entry mode. → 

Note:

-  in the following tables represents a single space.

Useful Information

Alphabet character table (ABC)

0	1	2	3	4	5	6	7	8	9	#
~ 0	& ' () * , - . / 1	A B C	D E F	G H I	J K L	M N O	P Q R	T U V	W X Y	#
		2	3	4	5	6	S 7	8	Z 9	
		a b c	d e f	g h i	j k l	m n o	p q r s	t u v	w x y	
		2	3	4	5	6	7	8	z 9	

Numeric entry table (0-9)

0	1	2	3	4	5	6	7	8	9	#
0	1	2	3	4	5	6	7	8	9	#

Greek character table (ΑΒΓ)

0	1	2	3	4	5	6	7	8	9	#
~ 0	& ' () * , - . / 1	A B Γ	Δ E Z	H Θ I	K Λ M	N Ξ O	Π P Σ	T Υ Φ	Χ Ψ Ω	#
		2	3	4	5	6	7	8	9	

Extended 1 character table (AĂÄ)

0	1	2	3	4	5	6	7	8	9	#
~ 0	& ' () * , - . / 1	A À Á	D E È	G Ğ H	J K L	M N Ñ	P Q R	T U Û	W Ŷ X	#
		Â Ã Ä	É Ê Ë	Ì Í Î	5	O Ò Ó	S Ş ß	Ú Û Ü	Ý Þ Z	
		Å Æ B	Ë Ì Í	Ĵ Ķ Ŀ		Ô Õ Ö	7	Û Ü V	8	
		C Ç 2	4			ø 6				
		a à á	d e è	g ğ h	j k l 5	m n ñ	p q r s	t u ù	w ŷ x	
		â ã ä	é ê ë	ì í î		o ò ó	ş ß 7	ú û ü	ý þ z	
		å æ b	ë ì í	ĵ ħ ĩ		ô õ ö		û v 8	9	
		c ç 2	4			ø 6				

- The following are used for both uppercase and lowercase: ø Ŷ ŷ

Extended 2 character table (ŠŚŠ)

0	1	2	3	4	5	6	7	8	9	#
~ 0	& ' () * , - . / 1	A Á Ä	D Ę E	G Ħ I	J K L	M N Ń	P Q R	T Ŧ U	W X Y	#
		Å B C	É Ę Ě	Í 4	Ł Ł Ł	Ń Ó Ő	Ŕ Ŗ S	Ũ Ü Ů	Ÿ Ý Z	
		Č Ć 2	F 3		5	Ő Ő 6	Š Ś Š	7	ú v 8	
		a á ä	d ě e	g ħ í	j k l 4	m n ń	p q r	t ŧ u	w x y	
		Å b c	é ě ě	4	ł ł 5	ń ó ő	ŕ ŗ s	ú ů ů	ŷ ý z	
		č ě 2	f 3			ő ő 6	š ś š	7	ú v 8	ž ž ž
									9	

Useful Information

- The following are used for both uppercase and lowercase:

À Á Ć Ć Ę Ł Ł Ł Ń Ŕ Ś Ś ŝ ũ ŷ Ž Ž Ž

Cyrillic character table (АБВ)

0	1	2	3	4	5	6	7	8	9	#
Л О Г Є І І ÿ	& ' () * , - . / 1	А Б В Г 2	Д Е Ж З 3	И Й К Л 4	М Н О П 5	Р С Т У 6	Ф Х Ц Ч 7	Ш Щ Ъ Ы 8	Ь Э Ю Я 9	#

Error messages



Display message	Cause/solution
Base no power or No link. Reconnect AC adaptor.	<ul style="list-style-type: none"> Confirm the base unit's AC adaptor is connected to the unit and the power outlet correctly. The handset has lost communication with the base unit. Move closer to the base unit and try again. Unplug the base unit's AC adaptor to reset the unit. Reconnect the adaptor and try again. The handset's registration may have been cancelled. Re-register the handset (page 30).
Check Phone Line	<ul style="list-style-type: none"> The supplied telephone line cord has not been connected yet or not connected properly. Check the connections (page 8).
Error	<ul style="list-style-type: none"> Recording was too short. Try again.
Memory Full	<ul style="list-style-type: none"> The phonebook memory is full. Erase unwanted entries (page 19). The call block list memory is full. Erase unwanted entries (page 28). The maximum number of base units (4) is already registered to the handset. Cancel unused base unit registrations from the handset (page 30).
Use rechargeable battery.	<ul style="list-style-type: none"> A wrong type of battery such as alkaline or manganese was inserted. Use only the rechargeable Ni-MH batteries noted on page 3, 6.
You must first subscribe to Caller ID.	<ul style="list-style-type: none"> You must subscribe to a Caller ID service. Once you receive caller information after subscribing to a Caller ID service, this message will not be displayed.

Troubleshooting

If you still have difficulties after following the instructions in this section, disconnect the base unit's AC adaptor and turn off the handset, then reconnect the base unit's AC adaptor and turn on the handset.

Useful Information

General use



Problem	Cause/solution
The handset does not turn on even after installing charged batteries.	<ul style="list-style-type: none"> Place the handset on the base unit or charger to turn on the handset.
The unit does not work.	<ul style="list-style-type: none"> Make sure the batteries are installed correctly (page 8). Fully charge the batteries (page 9). Check the connections (page 8). Unplug the base unit's AC adaptor to reset the unit and turn off the handset. Reconnect the adaptor, turn on the handset and try again. The handset has not been registered to the base unit. Register the handset (page 30).
The handset display is blank.	<ul style="list-style-type: none"> The handset is not turned on. Turn the power on (page 12).
I cannot hear a dial tone.	<ul style="list-style-type: none"> Make sure that you are using the supplied telephone line cord. Your old telephone line cord may have a different wiring configuration. The base unit's AC adaptor or telephone line cord is not connected. Check the connections. Disconnect the base unit from the telephone line and connect the line to a known working telephone. If the working telephone operates properly, contact our service personnel to have the unit repaired. If the working telephone does not operate properly, contact your phone service provider.
The message indicator is flashing slowly and the handset display "Demo Mode".	<ul style="list-style-type: none"> Demonstration mode is activated. To turn off demonstration mode:  →  # 8 9 9

Menu list

Problem	Cause/solution
The display is in a language I cannot read.	<ul style="list-style-type: none"> Change the display language (page 12).
I cannot activate the eco mode.	<ul style="list-style-type: none"> You cannot set eco mode when you set the repeater mode "On". If required, set the repeater mode to "Off" (page 30).
I cannot register a handset to a base unit.	<ul style="list-style-type: none"> The maximum number of base units (4) is already registered to the handset. Cancel unused base unit registrations from the handset (page 30). The maximum number of handsets (6) is already registered to the base unit. Cancel unused handset registrations from the base unit (page 30). You entered the wrong PIN. If you forget your PIN, contact an authorised service centre.

Useful Information

Battery recharge

Problem	Cause/solution
The handset beeps and/or  flashes.	<ul style="list-style-type: none">● Battery charge is low. Fully charge the batteries (page 9).
I fully charged the batteries, but <ul style="list-style-type: none">–  still flashes or– the operating time seems to be shorter.	<ul style="list-style-type: none">● Clean the battery ends (\oplus, \ominus) and the charge contacts with a dry cloth and charge again.● It is time to replace the batteries (page 8).

Making/answering calls, intercom

Problem	Cause/solution
 is displayed.	<ul style="list-style-type: none">● The handset is too far from the base unit. Move closer.● The base unit's AC adaptor is not properly connected. Reconnect AC adaptor to the base unit.● The handset is not registered to the base unit. Register it (page 30).● Activating eco mode reduces the range of the base unit in standby mode. If required, turn eco mode off (page 13).
Noise is heard, sound cuts in and out.	<ul style="list-style-type: none">● You are using the handset or base unit in an area with high electrical interference. Re-position the base unit and use the handset away from sources of interference.● Move closer to the base unit.● If you use a DSL/ADSL service, we recommend connecting a DSL/ADSL filter between the base unit and the telephone line jack. Contact your DSL/ADSL provider for details.
Sound quality seems to be getting worse.	<ul style="list-style-type: none">● You have registered a handset that is not recommended (page 4). The clearest sound quality is only possible by registering the recommended handset.
The handset does not ring.	<ul style="list-style-type: none">● The ringer volume is turned off. Adjust ringer volume (page 15, 23).● Do not disturb mode is turned on. Turn it off (page 26).
I cannot make a call.	<ul style="list-style-type: none">● The dialling mode may be set incorrectly. Change the setting (page 14).● You dialled a call restricted number (page 28).● The key lock feature is turned on. Turn it off (page 17).

Useful Information

Caller ID

Problem	Cause/solution
Caller information is not displayed.	<ul style="list-style-type: none">• You must subscribe to a Caller ID service. Contact your phone service provider for details.• If your unit is connected to any additional telephone equipment, remove and plug the unit directly into the wall jack.• If you use a DSL/ADSL service, we recommend connecting a DSL/ADSL filter between the base unit and the telephone line jack. Contact your DSL/ADSL provider for details.• Other telephone equipment may be interfering with this unit. Disconnect the other equipment and try again.
Caller information is slow to display.	<ul style="list-style-type: none">• Depending on your phone service provider, the unit may display the caller's information at the 2nd ring or later. Set the first ring to "Off" (page 23).• Move closer to the base unit.
Time on the unit has shifted.	<ul style="list-style-type: none">• Incorrect time information from incoming Caller ID changes the time. Set the time adjustment to "Manual" (off) (page 23).
The name stored in the phonebook is not fully displayed while an outside call is being received.	<ul style="list-style-type: none">• Edit the phonebook entry name to fit in 1 line of text (page 19).

Answering system

Problem	Cause/solution
The unit does not record new messages.	<ul style="list-style-type: none">• The answering system is turned off. Turn it on (page 34).• The message memory is full. Erase unwanted messages (page 35).• The recording time is set to "Greeting Only". Change the setting (page 37).• Your phone service provider's voicemail service may be answering your calls before the unit's answering system can answer your calls. Change the unit's number of rings setting (page 37) to a lower value, or contact your phone service provider.• The answering system will not answer incoming calls while the other devices such as handsets are engaged in a call.
I cannot operate the answering system remotely.	<ul style="list-style-type: none">• The remote access code is not set. Set the remote access code (page 35).• You are entering the wrong remote access code. If you have forgotten your remote access code, enter the remote access code setting to check your current code (page 35).• The answering system is turned off. Turn it on (page 36).
The unit does not emit the specified number of rings.	<ul style="list-style-type: none">• If the first ring is turned off (page 23), the number of rings decreases by 1 from the specified number of rings.

Useful Information

Liquid damage

Problem	Cause/solution
Liquid or other form of moisture has entered the handset/base unit.	<ul style="list-style-type: none">● Disconnect the AC adaptor and telephone line cord from the base unit. Remove the batteries from the handset and leave to dry for at least 3 days. After the handset/base unit are completely dry, reconnect the AC adaptor and telephone line cord. Insert the batteries and charge fully before use. If the unit does not work properly, contact an authorised service centre.

Caution:

- To avoid permanent damage, do not use a microwave oven to speed up the drying process.

Index

- A** Additional base units: 29
Additional handsets: 29
Alarm: 26
Answering calls: 15
Answering system: 34
 Call screening: 36
 Erasing messages: 35, 36
 Greeting message: 34
 Greeting only: 37
 Listening to messages: 35, 36
 Number of rings: 37
 Recording time: 37
 Remote access code: 35
 Remote operation: 35
 Turning on/off: 34
Area code: 28
Auto talk: 15, 24
- B** Base unit
 Cancelling: 30
 Selecting: 30
Battery: 8, 9
- C** Call restriction: 28
Call share: 16
Call waiting: 16
Call Waiting Caller ID: 16
Caller ID service: 32
Caller list: 32
Caller list edit: 32
Category: 18
Chain dial: 19
Character entry: 38
Conference calls: 16
Control type: 11
- D** Date and time: 13
Dialling mode: 14
Direct command code: 21
Display
 Contrast: 23
 Language: 12
Do not disturb mode: 26
- E** Eco mode: 13
Equalizer: 16
Error messages: 40
- F** First ring: 23
- H** Handset
 Deregistration: 30
 Locator: 10
 Name: 28
 Registration: 30
 Hold: 15
- I** Intercom: 17
- K** Key lock: 17
Keytones: 24
- M** Making calls: 15
Message indicator: 13
Missed calls: 32
Mute: 15
- N** Nuisance call block: 27
- P** Pause: 15
Phonebook: 18
PIN: 29
Power failure: 9
Power on/off: 12
Privacy mode: 24
- R** Recall/flash: 16
Redialling: 15
Repeater: 30
Ringer tone: 23
- S** Security for phone calls: 29
Speakerphone: 15
Speed dial: 19
- T** Temporary tone dialling: 16
Time adjustment: 23
Transferring calls: 16
Troubleshooting: 40
- V** Voicemail: 38
Volume
 Receiver: 15
 Ringer (Handset): 15, 23
 Speaker: 15

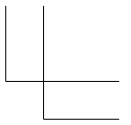
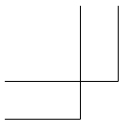

Notes

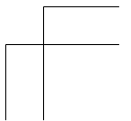
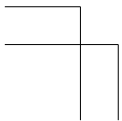
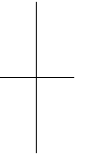
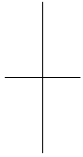

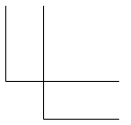
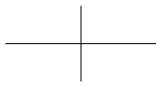
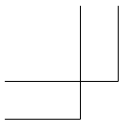

Notes

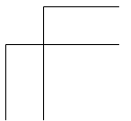
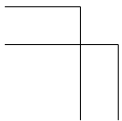
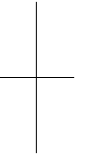
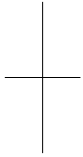

For your future reference

We recommend keeping a record of the following information to assist with any repair under warranty.

Serial No.	Date of purchase
(found on the bottom of the base unit)	
Name and address of dealer	

Attach your purchase receipt here.

Panasonic Corporation
1006, Oaza Kadoma, Kadoma-shi, Osaka 571-8501, Japan
<http://www.panasonic.com>

© Panasonic Corporation 2017



PNQX8523YA

PNQX8523YA PP0517AN0907