

Panasonic[®]

Operating Instructions Washer and Dryer

Model no: NA-S128M2*

Thank you very much for purchasing Panasonic Washing Machine

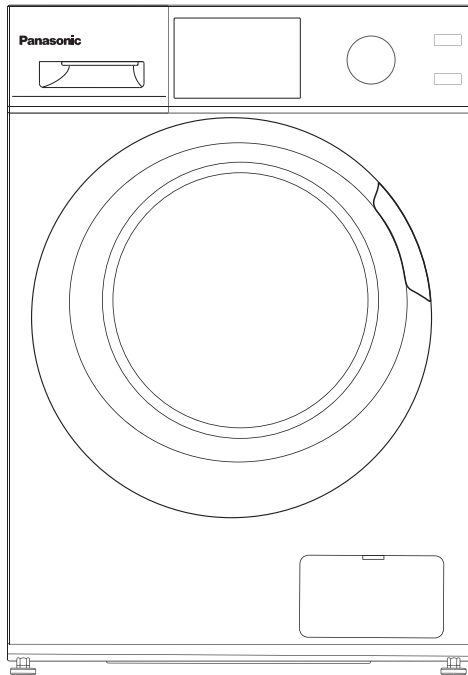

*Picture is only for illustration

*WAE:White

*LAE:Silver

Before operating this unit, please completely read these instructions especially the **Safety Precautions and Important Instructions.**

CONTENTS

SAFETY INSTRUCTIONS

■ Safety Instructions	2
-----------------------------	---

INSTALLATION

■ Product Description	8
■ Installation	9

OPERATIONS

■ Quick Start	12
■ Before Each Washing	13
■ Detergent Dispenser	14
■ Control Panel	16
■ Option.....	17
■ Other Functions	19
■ Programmes.....	22
■ Washing Programmes Table	23

MAINTENANCES

■ Cleaning And Care	24
■ Trouble Shooting	27
■ Technical Specifications	28

SAFETY INSTRUCTIONS

■ Safety Instructions

For your safety, the information in this manual must be followed to minimize the risk of fire or explosion, electric shock, or to prevent property damage, personal injury or loss of life.

Explanation of the symbols:

Warning!

This combination of symbol and signal word indicates a potentially dangerous situation which may result in death or serious injuries unless it's avoided.

Caution!

This combination of symbol and signal word indicates a potentially dangerous situation which may result in slight or minor injuries or damage to property and the environment.

Note!

This combination of symbol and signal word indicates a potentially dangerous situation which may result in slight or minor injuries.

Warning!

The electric shock!

- If the supply cord is damaged, it must be replaced by the manufacturer, its service agent or similarly qualified persons in order to avoid a hazard.
- The new hose-sets supplied with the appliance are to be used and that old hose-sets should not be reused.
- Before any maintenance the device, unplug the appliance from the mains.

SAFETY INSTRUCTIONS

- Always unplug the machine and turn off the water supply after use. The max. inlet water pressure, in pascals. The min. inlet water pressure, in pascals.
- To ensure your safety, power plug must be inserted into an earthed three-pole socket. Check carefully and make sure that your socket is properly and reliably earthed.
- Make sure that the water and electrical devices must be connected by a qualified technician in accordance with the manufacturer's instructions and local safety regulations.
- Pull out its plug from the power socket before cleaning or maintenance.
- Do not use any socket with rated current less than that of appliance. Never pull out power plug with wet hand.
- Please remember to disconnect water and power supply immediately after the clothes are washed.

Risk to children!

- EN countries: the appliance can be used by children aged from 8 years and above and persons with reduced physical, sensory or mental capabilities or lack of experience and knowledge if they have been given supervision or instruction concerning use of the appliance in a safe way and understand the hazards involved. Children shall not play with the appliance. Cleaning and user maintenance shall not be made by children without supervision.
- Children of less than 3 years should be supervised to ensure that they do not play with appliance.
- Animals and children may climb into the machine. Check the machine before every operation.
- Kids should be supervised that they do not play with the appliance.

SAFETY INSTRUCTIONS

- Glass door may be very hot during the operation. Keep kids and pets far away from the machine during the operation very wet rooms as well as in the rooms with explosive or caustic gas.
- Remove all packages and transport bolts before using the appliance. Otherwise, serious damage may result.

Risk of explosion!

- Do not wash or dry articles that have been cleaned in, washed in, soaked in, or dabbed with combustible or explosive substances(such as wax, oil, paint, gasoline, degreasers, dry-cleaning solvents, kerosene, etc.) This may result in fire or explosion.
- The washer dryer is not to be used if industrial chemicals have been used for cleaning.
- The exhaust air must not be discharged into a flue which is for exhausting fumes from appliances burning gas or other fuels.
- Before hand thoroughly rinse items of washing by hand.

⚠ Caution!

Installing the product!

- This appliance is for indoor use only.
- It isn't intended to be built-in using.
- The openings must not be obstructed by a carpet.
- The appliance shall not be installed in bath room or very wet rooms as well as in the rooms with explosive or caustic gases.
- The appliance with single inlet valve only can be connected to the cold water supply. The appliance with double inlet valves should be correctly connected to the

SAFETY INSTRUCTIONS

hot water and cold water supply.

- Plug must be accessible after installation.
- The appliance must not be installed behind a lockable door, a sliding door or a door with a hinge on the opposite side to that of the washer dryer.
- The appliance shall not be installed at a humid place.
- The household appliance isn't intended to be built-in.
- Remove all packages and transport bolts before using the appliance. Otherwise, serious damage may result.

Risk of damaging appliance!

- The product is only for home use and is only designed for the textiles suitable for machine washing and drying.
- Do not climb up and sit on top cover of the machine.
- Do not lean against machine door.
- Cautions during Handling Machine:
 1. Transport bolts shall be reinstalled to the machine by a specialized person.
 2. The accumulated water shall be drained out of the machine.
 3. Handle the machine carefully. Never hold each protruded part on the machine while lifting. Machine door can not be used as the handle during the conveyance.
 4. This appliance is heavy. Transport with care.
 5. That the hands shall not be inserted into running water extracting tub.
- Please do not close the door with excessive forces. If it is found difficult to close the door, please check if the clothes are put in or distributed well.
- It is forbidden to wash carpets.

Operating the appliance!

SAFETY INSTRUCTIONS

- Before washing the clothes at first time, the product shall be operated in one round of the whole procedures without the clothes inside.
- Flammable and explosive or toxic solvents are forbidden. Gasoline and alcohol etc. Shall not be used as detergents. Please only select the detergents suitable for machine washing, especially for drum.
- Make sure that all pockets are emptied. Sharp and rigid items such as coin, brooch, nail, screw or stone etc. may cause serious damages to this machine.
- Please check whether the water inside the drum has been drained before opening its door. Please do not open the door if there is any water visible.
- Be careful of burning when the product drains hot washing water.
- After the program is completed, Please wait for two minutes to open the door (Some model).
- Never refill the water by hand during washing.
- If it is unavoidable that fabrics that contain vegetable or cooking oil or have been contaminated by hair care products. it be placed in a tumble dryer they should first be washed in hot water with extra detergent, this will reduce, but not eliminate, the hazard.
- Adequate ventilation has to be provided to avoid the back flow of gases into the room from appliances burning other fuels, including open fires.
- Do not dry unwashed items in the appliance.
- Items that have been soiled with substances such as cooking oil, acetone, alcohol, petrol, kerosene, spot removers, turpentine, waxes and wax removers should be washed in hot with an extra amount of detergent before being dried in the appliance.

SAFETY INSTRUCTIONS

- Items such as foam rubber (latex foam), shower caps, water proof textiles, rubber backed articles and clothes or pillows fitted with foam rubber pads should not be dried in the machine.
- Fabric softeners, or similar products, should be used as specified by the fabric softener instructions.
- The machine whose lid can be opened during water extraction, that it takes 15s or more for complete stop of water extracting chamber tub.
- The final part of a washer dryer cycle occurs without heat (cool down cycle) to ensure that the items are left at a temperature that ensures that the items will not be damaged.
- Remove all objects from pockets such as lighters and matches before use the appliance.
- **WARNING:** Never stop a washer dryer before the end of the drying cycle unless all items are quickly removed and spread out so that the heat is dissipated.

Packaging/Old appliance



This marking indicates that this product should not be disposed with other household wastes throughout the EU. To prevent possible harm to the environment or human health from uncontrolled waste disposal, recycle it responsibly to promote the sustainable reuse of material resources. To return your used device, please use the collection systems or contact the retailer where the product was purchased. They return and can take this product for environmental safe recycling.

INSTALLATION

■ Product Description

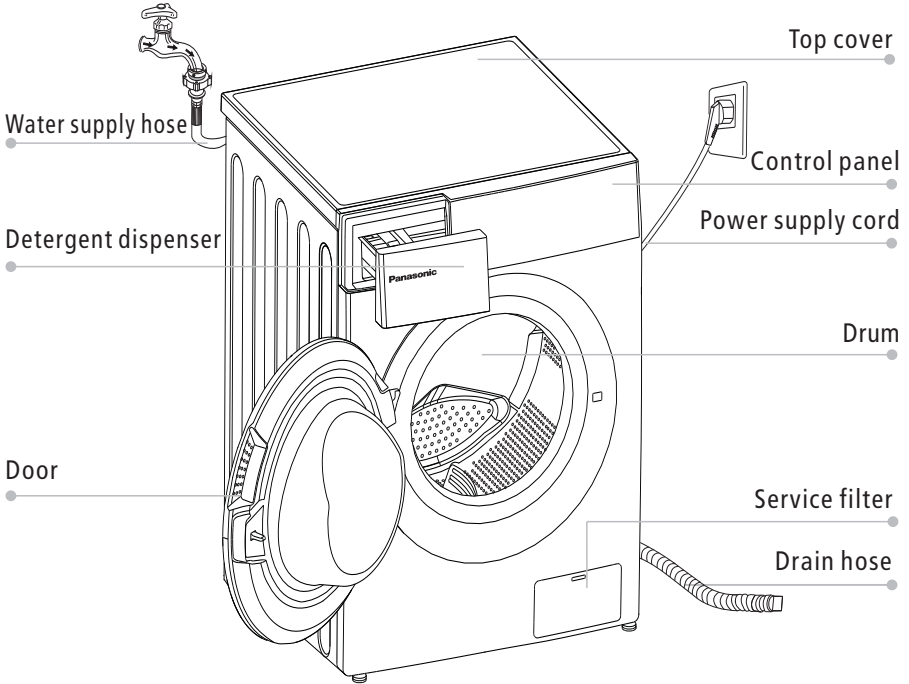

📌 Note!

- The product line chart is for reference only, please refer to real product as standard.

Accessories

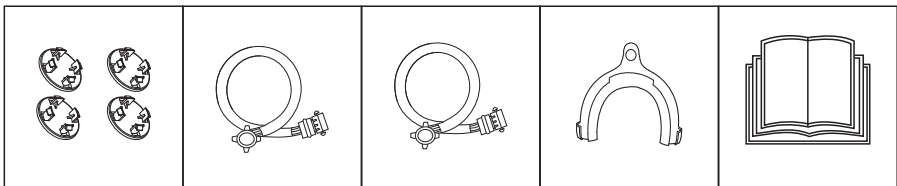

Transport hole plug

Supply hose cold water

Supply hose hot water (optional)

Drain hose support (optional)

Owner's manual

INSTALLATION

■ Installation

Installation area

⚠ Warning!

- Stability is important to prevent the product from wandering!
- Make sure that the product should not stand on the power cord.

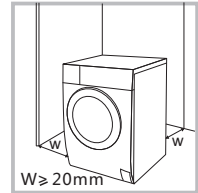

Before installing the machine, the location characterized as follows shall be selected:

1. Rigid, dry, and level surface
2. Avoid direct sunlight
3. Sufficient ventilation
4. Room temperature is above 0°C
5. Keep far away from the heat resources such as coal or gas.

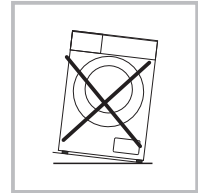

Unpacking the washing machine

⚠ Warning!

- Packaging material (e.g. Films, Styrofoam) can be dangerous for children.
- There is a risk of suffocation ! Keep all packaging well away from children.

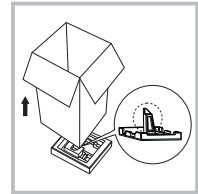

1. Remove the cardboard box and styrofoam packing.
2. Lift the washer dryer and remove the base packing. Make sure the small triangle foam is removed with the bottom one together. If not, lay the unit down with side surface, then remove the small foam from the unit bottom manually.
3. Remove the tape securing the power supply cord and drain hose.
4. Remove the inlet hose from the drum.

Remove transport bolts

⚠ Warning!

- You must remove the transport bolts from the backside before using the product.
- You'll need the transport bolts again if you move the product, so make sure you keep them in a safe place.

Please take the following steps to remove the bolts:

1. Loosen 4 bolts with spanner and then remove them.
2. Stop the holes with transport hole plugs.
3. Keep the transport bolts properly for future use.

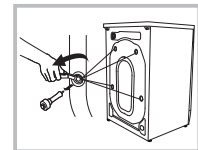

INSTALLATION

Levelling the washer dryer

⚠ Warning!

- The lock nuts on all four feet must be screwed tightly against the housing.

1. Check if the legs are closely attached to the cabinet. If not, please turn them to their original positions tighten the nuts.
2. Loosen the lock nut turn the feet until it closely contacts with the floor.
3. Adjust the legs and lock them with a spanner, make sure the machine is steady.

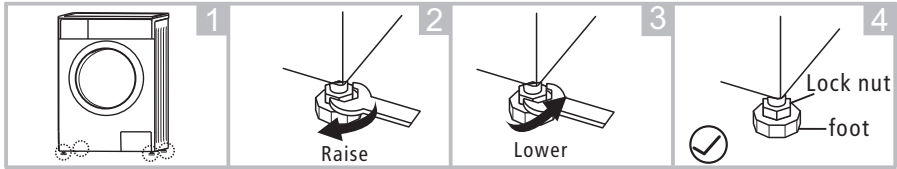

Connect Water Supply Hose

⚠ Warning!

- To prevent leakage or water damage, follow the instructions in this chapter!
- Do not kink, crush, modify or sever water inlet hose.
- For the model equips hot valve, connect it to hot water tap with hot water supply hose. Energy consumption will decrease automatically for some program.

Connect the inlet pipe as indicated, There are two ways to connect the inlet pipe.

1. Connection between ordinary tap and inlet hose.

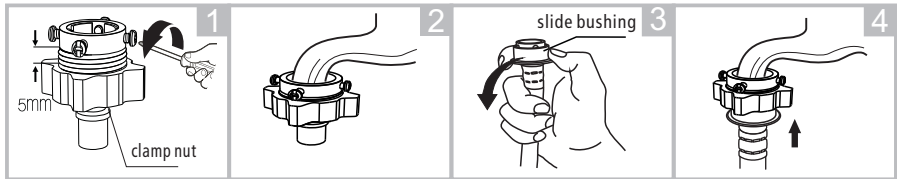

Loosen clamp nut and four bolts

Tighten clamp nut

Press slide bushing, insert inlet hose into connecting base

Connection finished

2. Connection between screw tap and inlet hose.

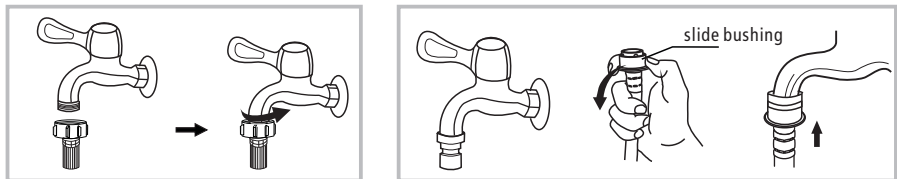

Tap with threads and inlet hose

Special tap for washer dryer

INSTALLATION

Connect the other end of inlet pipe to the inlet valve at the backside of product and fasten the pipe tightly clockwise.

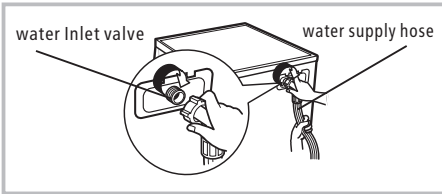

Drain Hose

⚠ Warning!

- Do not kink or protract the drain hose.
- Position drain hose properly ,otherwise damage might result of water leakage.

There are two ways to place the end of drain hose:

1.Put it into the water trough.

2.Connect it to the branch drain pipe of the trough.

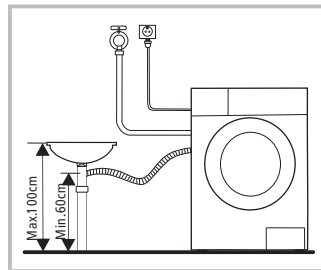
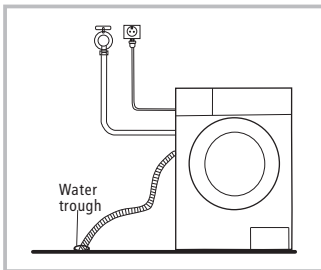

📌 Note!

- If the machine has drain hose support, please install it like the following .

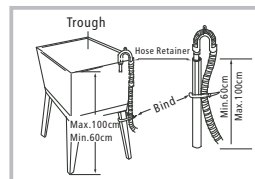
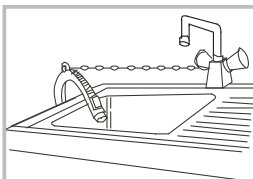

⚠ Warning!

- When installing drain hose, fix it properly with a rope.
- If drain hose is too long, do not force it into washing machine as it will cause abnormal noises.

OPERATIONS

■ Quick Start

⚠ Caution!

- Before washing, please make sure it's installed properly.
- Before washing at first time, the washing machine shall be operated in one round of the whole procedures without clothes in as follows.

1. Before Washing

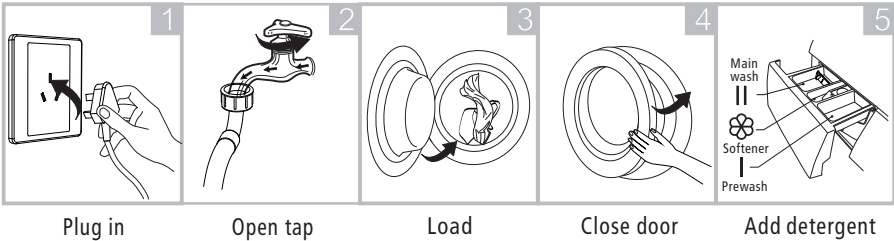

📌 Note!

- Detergent only need to be added in "case I" after selecting pre-washing for machines with this function.

2. Washing

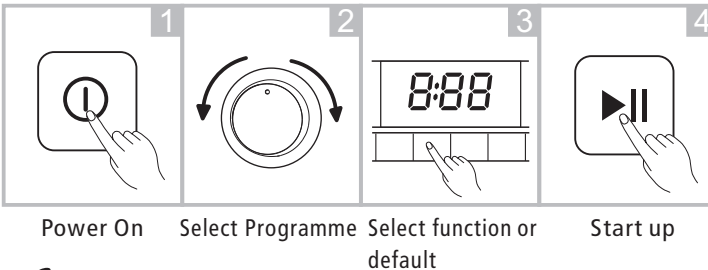

📌 Note!

- 1.If default is selected, step 3 can be skipped.
- 2.The function button line chart is for reference only, please refer to real product as standard.

3. After Washing

Buzzer beep or "End" on display.

OPERATIONS

■ Before Each Washing

- The working condition of the washer should be (0-40)°C. If used under 0°C, the inlet valve and draining system may be damaged. If the machine is placed under condition of 0°C or less, then it should be transferred to normal ambient temperature to ensure the water supply hose and drain hose are not frozen before use.
- Please check the labels and the explanation of using detergent before wash. Use non-foaming or less-foaming detergent suitable for machine washing properly.

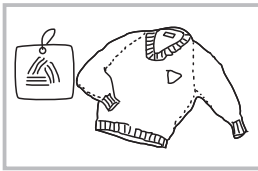

Check the label

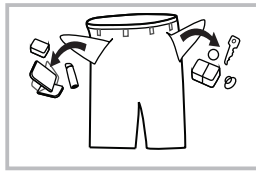

Take out the items out of the pockets

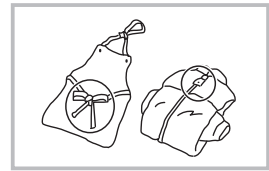

Knot the long strips, zip or button

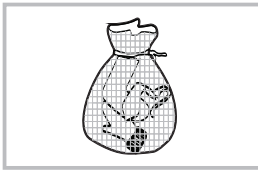

Put small clothes into the pillow slip

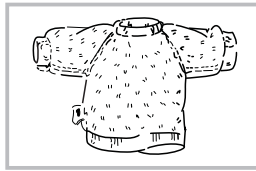

Turn easy-pilling and long-pile fabric inside out

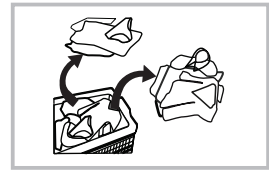

Separate clothes with different textures

⚠ Warning!

- When washing a single clothes, it may easily cause great eccentricity and give alarm due to great unbalance. Therefore it is suggested to add one or two more clothes to be washed together so that draining can be done smoothly.
- Don't washing the clothes touching with kerosene, gasoline, alcohol and other flammable materials.

OPERATIONS

■ Detergent Dispenser

- I Pre wash detergent
- II Main wash detergent
- ☼ Softener

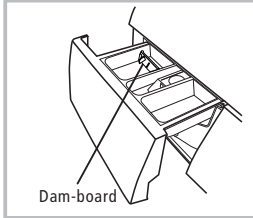

Dam-board

Liquid detergent

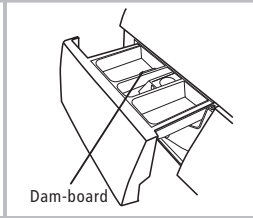

Dam-board

Powder detergent

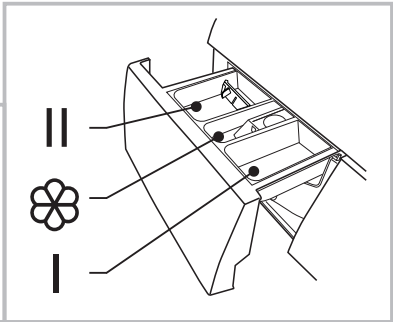

Pull out the dispenser

⚠ Caution!

- Detergent only need to be added in "case I" after selecting pre-washing for machines with this function.

Programme	I	II	☼	Programme	I	II	☼
Cotton ECO		●	○	Rinse&Spin			○
Sport Wear		●	○	Dry Only			
Rapid 15'		●	○	Mix	○	●	○
Delicate		●	○	Baby Care	○	●	○
Wool		●	○	Synthetic	○	●	○
Colors		●	○	Cotton	○	●	○
Jeans	○	●	○	1Hour W/D		●	○
Spin Only			○				

● Means must ○ Means optional

OPERATIONS

Programme			☼	Programme			☼
Cotton ECO		●	○	Rinse&Spin			○
Sport Wear	○	●	○	Dry Only			
Rapid 15'	○	●	○	Mix	○	●	○
Delicate		●	○	Baby Care	○	●	○
Wool		●	○	Synthetic	○	●	○
Colors		●	○	Cotton	○	●	○
Jeans	○	●	○	1Hour W/D		●	○
Spin Only							

● Means must ○ Means optional

Note!

- As for the agglomerated or ropy detergent or additive, before they are poured into the detergent box, it is suggested to use some water for dilution to prevent the inlet of detergent box from being blocked and overflowing while filling water.
- Please choose suitable type of detergent for the various washing temperature to get the best washing performance with less water and energy consumption.

OPERATIONS

Control Panel

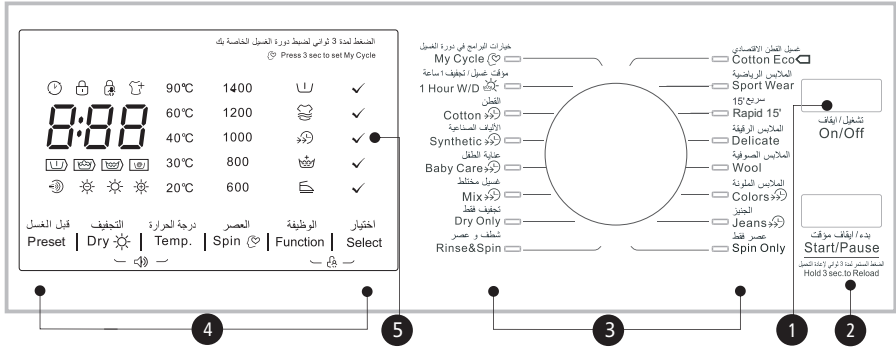

Note!

- The chart is for reference only, Please refer to real product as standard.
- The programme with can be choose speed wash function.

1 On/Off
Product is switched on or off.

2 Start/Pause
Press the button to start or pause the washing cycle.

3 Option
This allows you to select an additional function and will light when selected.

4 Programmes
Available according to the laundry type.

5 Display
The display shows the settings, estimated time remaining, options, and status messages for your washer. The display will remain on through the cycle.

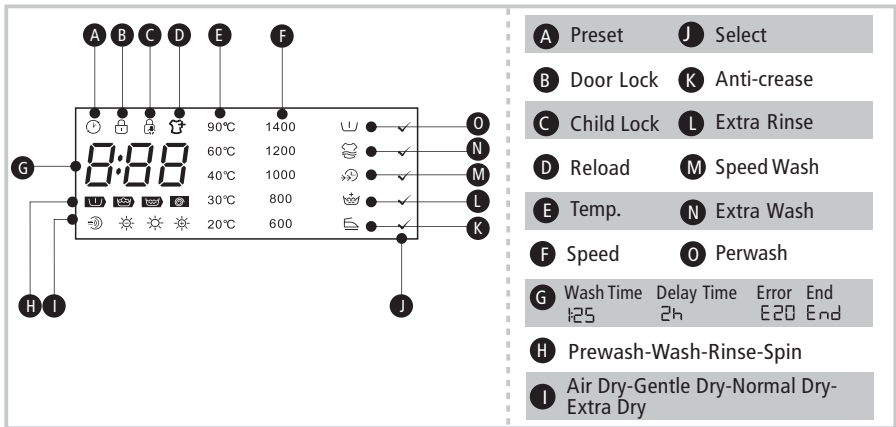

OPERATIONS

■ Option



Pre Wash

The Prewash function can get an extra wash before main wash, it is suitable for washing the dust rises to surface of the clothes; You need to put detergent into the Case (I) when select it.



Extra Rinse

The laundry will undergo extra rinse once after you select it.



Speed Wash

The function can decrease the washing time.



Preset

Set the Preset function:

1. Select a programme
2. Press the Preset button to choose the time (the delaying time is 0-24 H.)
3. Press [Start/Pause] to commence the preset operation



On/Off

Choose the Programme

Setting time

Start

Cancel the Preset function:

Press the [Preset] button until the display be 0H. It should be pressed before starting the programme. If the programme already started, should press the [On/Off] button to reset the programme.

! Caution!

- If there is any break in the power supply while the machine is operating, a special memory stores the selected programme and when the power is restarted, press the [On/Off] button the program will continue.
-



Extra Wash

Very dirty clothes can choose it, select it can increase the washing time and intensity to increase the washing effect.



Anti-crease

Anti-crease function can be used to reduce the wrinkles of clothes.

OPERATIONS

Programme	Option					
	Preset	Speed Wash	Extra Rinse	Perwash	Extra Wash	Anti-crease
Cotton ECO	<input type="radio"/>					
Sport Wear	<input type="radio"/>		<input type="radio"/>	<input type="radio"/>	<input type="radio"/>	<input type="radio"/>
Rapid 15'	<input type="radio"/>					
Delicate	<input type="radio"/>		<input type="radio"/>			<input type="radio"/>
Wool	<input type="radio"/>		<input type="radio"/>			<input type="radio"/>
Colors	<input type="radio"/>	<input type="radio"/>	<input type="radio"/>			<input type="radio"/>
Jeans	<input type="radio"/>	<input type="radio"/>	<input type="radio"/>	<input type="radio"/>		<input type="radio"/>
Spin Only	<input type="radio"/>					<input type="radio"/>
Rinse&Spin	<input type="radio"/>		<input type="radio"/>			<input type="radio"/>
Dry Only	<input type="radio"/>					
Mix	<input type="radio"/>	<input type="radio"/>	<input type="radio"/>	<input type="radio"/>	<input type="radio"/>	<input type="radio"/>
Baby Care	<input type="radio"/>	<input type="radio"/>	<input type="radio"/>	<input type="radio"/>	<input type="radio"/>	<input type="radio"/>
Synthetic	<input type="radio"/>	<input type="radio"/>	<input type="radio"/>	<input type="radio"/>	<input type="radio"/>	<input type="radio"/>
Cotton	<input type="radio"/>	<input type="radio"/>	<input type="radio"/>	<input type="radio"/>	<input type="radio"/>	<input type="radio"/>
1 Hour W/D	<input type="radio"/>					

OPERATIONS

■ Other functions



Reload

This operation can be executed during the washing progress. When the drum is still rolling and there is large amount of water with high temperature in the drum. The state is unsafe and the door cannot be opened forcefully. To press [Start/Pause] for 3 sec. to reload, and start the clothes adding in the midway function. Please follow the steps as bellow:

- 1.Wait until the drum stops rotation.
- 2.The door lock is unlocked.
- 3.Close the door when the clothes are reloaded and press the [Start/Pause] button.



Press [Start/Pause] 3sec.

Reload the clothes

Start

⚠ Caution!

- Don't use the Reload function when the water level over the edge of the inner tub or the temperature is higher.



My Cycle

Memory the frequently used programmes

Press [♥] 3sec. to memory the running programme. The default is cotton.



Child Lock

To avoid mis operation by children.



On/Off

Start/Pause

Press [Function] and [Select]
3 sec. till buzzer beep.

⚠ Caution!

- Press the two button 3sec. also to be released the function.
- The "Child Lock" will lock all buttons except [On/Off].
- Cut off the power supply , the kid's protection is to be released.
- The child lock will remain effective when the power is resumed for some models.

OPERATIONS

Temp.

Temp.

Press the button to regulate the temperature(Cold,20°C,30°C, 40°C,60°C,90°C)

Speed

Speed

Press the button to change the spin speed.

Programme	Default Speed(rpm)		Programme	Default Speed(rpm)	
	1400	1600		1400	1600
Cotton ECO	800	1400	Spin Only	1200	1200
Sport Wear	1600	800	Rinse&Spin	1200	1200
Cotton	800	800	Dry Only	1400	1600
Rapid 15'	800	800	Mix	800	800
Delicate	800	800	Baby Care	800	800
Wool	800	800	Synthetic	800	800
Colors	1200	1200	Cotton	800	800
Jeans	800	800	1Hour W/D	1400	1400

⚠ Caution!

- When the lights of speed are off means the spin speed is 0.

OPERATIONS



Mute the buzzer



On/Off Start/Pause Press the [Dry]&[Temp.]button
for 3sec.the buzzer is mute.

To act the buzzer function, press the two buttons again for 3 seconds. The setting will be kept until the next reset.

⚠ Caution!

- After Muting the buzzer function, the sounds will not be activated any more.



Dry

Press the Dry button continuously to choose the dry level: Extra Dry/Normal Dry/Gentle Dry/Air Dry.

☀ Extra Dry:Need to wear clothes immediately ,we can choose this function

☀ Normal Dry: The normal dry procedure

☀ Gentle Dry:Only to dry slightly and then is just ok .

🌀 Air Dry: Clothes is roated to remove peculiar smell without water in high temperature.

📌 Note!

- Drying hints
 - Clothes could be dried after spinning
 - To ensure quality dry the textiles, please classify them according to their kinds and the drying temperature.
 - Synthetic should be set the proper drying time .
 - If you want to iron the clothes after drying, please put them for a while.
- Clothes not suitable for drying
 - Particularly delicate items such as synthetic curtains,woolen and silk, clothes with metal inserts,nylon stockings,bulky clothes,such as anoraks,bedcovers,quilts,sleeping bags and duvets must not be dried.
 - Clothes padded with foam-rubber or materials similar to foam-rubber must not be machine dried.
 - Fabrics containing residues of setting lotions or hair sprays, nail solvents or similar solutions must not be machine dried in order to avoid the formation of harmful vapours.



Option Confirm

Confirm the selection of the Pre Wash,Extra Rinse,Extra Wash,Night Wash or Anti-crease function.

OPERATIONS

■ Programmes

Programmes are available according to the laundry type.

Programmes	
Cotton	Hard-wearing textiles, heat-resistant textiles made of cotton or linen.
Cotton ECO	To increase the washing effects, washing time is increased.
Synthetic	Wash synthetic articles, for example: shirts, coats, blending. While washing the knitting textiles, detergent quantity shall be reduced due to its loose string construction and easily forming bubbles.
Baby Care	Washing the baby's clothes, it can make the baby's wear cleaner. and make the rinse performance better to protect the baby skin.
Jeans	Specially for jeans.
Mix	Mixed load consisting of textiles made of cotton and synthetics.
Colors	Washing brightly colored clothes, it can protect the colors better .
Sport Wear	Washing the activewear.
Rapid 15'	Extra short programme approx, suitable for lightly soiled washing as a small amounts of laundry.
Delicate	For delicate, washable textiles, e.g. made of silk, satin, synthetic fibres or blended fabrics.
Wool	Hand or machine-washable wool or richwool textiles. Especially gentle wash programme to prevent shrinkage, longer programme pauses (textiles rest in wash liquor).
Spin Only	Extra spin with selectable spin speed.
Rinse&Spin	Extra rinse with spin.
Dry Only	Select it to dry clothes, the temperature is different .The drying time according to the load .
1 Hour W/D	For small synthetic clothes or shirts, load limitation is 1 kg (about 4 shirts). When you have an urgent appointment but no more clean shirt left in your cupboard, this program will help you. Time duration is only 1 hour including wash and dry. Remark: Big towels or jeans is not suitable for this program, they will enlarge the time duration and affect the moisture content.

Note!

- Reference to your product to select the programmes.

OPERATIONS

■ Washing Programmes Table

Programme	Washing/Drying Load (kg)	Temp.(°C)	Default Time(H)
	12.0	Default	12.0
Cotton Eco	12.0	60	4:44
Sport Wear	6.0	40	0:45
Rapid 15'	10.0	Cold	0:15
Delicate	2.5	30	0:50
Wool	2.0	40	1:07
Colors	12.0	Cold	1:10
Jeans	12.0	60	1:45
Spin Only	12.0	—	0:12
Rinse&Spin	12.0	—	0:20
☼ Dry Only	-/8.0	—	5:39
☼ Mix	12.0/8.0	40	1:13
☼ Baby Care	12.0/6.0	30	1:20
☼ Synthetic	6.0/6.0	40	1:40
☼ Cotton	12.0/5.0	40	2:40
☼ 1Hour /WD	1.0/1.0	Cold	0:59

- The UAE energy efficiency class is: ★★☆☆(12kg)
Energy test program: Cotton 60°C, Speed: the highest speed; Temp.:60°C;Other as the default.
The SNAS Energy Efficiency class is:B(12kg)
Energy test program: Cotton Eco , Temp.: 60°C; Speed: the highest speed;Other as the default.
Half load for 12.0Kg machine:6.0Kg.
- "Cotton 40°C" is the standard washing program and "Dry only " is the standard drying programs to which the information in the label and the fiche relates, and they are suitable to clean normally soiled cotton laundry and that they are the most efficient programmes in terms of combined energy and water consumptions for washing that type of cotton laundry,that the actual water temperature may differ from the declared cycle temperature.

Note!

- The parameters in this table are only for user's reference. The actual parameters maybe different with the parameters in above mentioned table.
- The programme with ☼ can be choose dry function.

MAINTENANCES

■ Cleaning And Care

Warning!

- Before your maintenance starts, please unplug the machine and close the tap.

Cleaning The Cabinet

Proper maintenance on the washing machine can extend its working life. The surface can be cleaned with diluted non-abrasive neutral detergents when necessary. If there is any water overflow, use the wet cloth to wipe it off immediately. No sharp items are allowed.

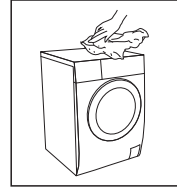

Note!

- Formic acid and its diluted solvents or equivalent are forbidden, such as alcohol, solvents or chemical products, etc.

Cleaning The Drum

The rusts left inside the drum by the metal articles shall be removed immediately with chlorine-free detergents. Never use steel wool.

Note!

- Don't put laundry in the washing machine during the drum cleaning.

Cleaning The Door Seal And Glass

Wipe the glass and seal after each wash to remove lint and stains. If lint builds up it can cause leaks. Remove any coins, buttons and other objects from the seal after each wash.

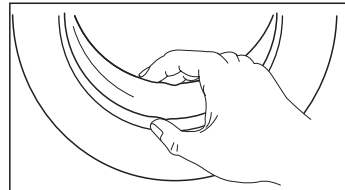

MAINTENANCES

Cleaning The Inlet Filter

Note!

- Inlet filter must be cleaned if there is less water.

Washing the filter in the tap

1. Close the tap.
2. Remove the water supply hose from the tap.
3. Clean the filter.
4. Reconnect the water supply hose.

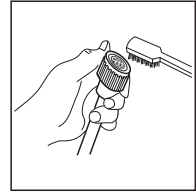
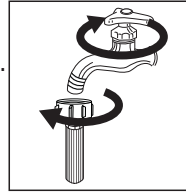

Washing the filter in washer dryer:

1. Screw off the inlet pipe from the backside of the machine.
2. Pull out the filter with long nose pliers and reinstall it back after being washed.
3. Use the brush to clean the filter.
4. Reconnect the inlet pipe.

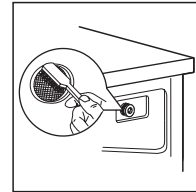
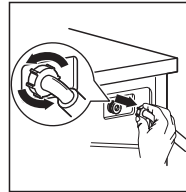

Note!

- If the brush is not clean, you can pull out the filter washed separately;
- Reconnect, turn on the tap.

Clean Detergent Dispenser

1. Press down the arrow location on softener cover inside the dispenser drawer.
2. Lift the clip up and take out softener cover and wash all grooves with water.
3. Restore the softener cover and push the drawer into position.

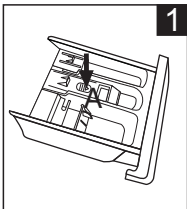

1 Pull out the dispenser drawer with press the A

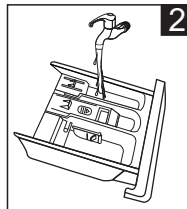

2 Clean the dispenser drawer under water

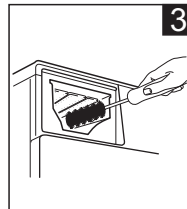

3 Clean inside the recess with an old toothbrush

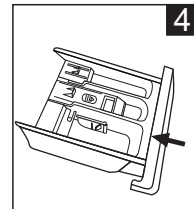

4 Insert the dispenser drawer

Note!

- Do not use alcohol, solvents or chemical products to clean the machine.

MAINTENANCES

Cleaning Drain Pump Filter

⚠ Warning!

- Be careful of the hot water!
- Allow detergent solution to cool down.
- Unplug the machine to avoid electrical shock before washing.
- Drain pump filter can filter the yarns and small foreign matters from the washing.
- Clean the filter periodically to ensure the normal operation of washing machine.

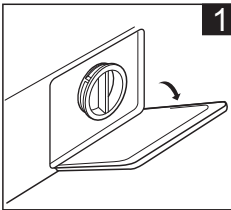

Open the lower cover cap

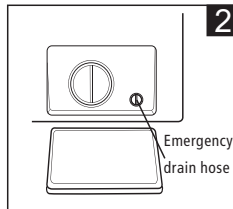

Rotate 90°C and pull out the emergency drain hose, and take off the hose cap

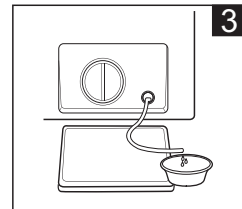

After water runs out, reset the drain hose

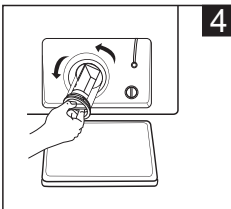

Open the filter by turning to the counter clockwise

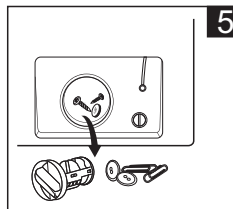

Remove extraneous matter

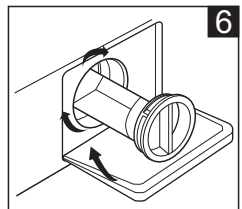

Close the lower cover cap

⚠ Caution!

- Make sure that valve cap and emergency drain hose are reinstalled properly, cap plates should be inserted aligning to hole plates otherwise water may leak;
- Some machines don't have emergency drain hose, so step 2 and step 3 can be skipped. Rotate lower cover cap directly to make water run into basin.
- When the appliance is in use and depending on the programme selected there can be hot water in the pump. Never remove the pump cover during a wash cycle, always wait until the appliance has finished the cycle, and is empty. When replacing the cover, ensure it is securely re-tightened.

MAINTENANCES

■ Trouble Shooting

The start of the appliance does not work or it stops during operation. First try to find a solution to the problem, If not, contact the service centre.

Description	Reason	Solution
Washer dryer cannot start up	Door is not closed properly	Restart after the door is closed Check if the clothes is stuck
Door can't be opened	Washer's safety protection design is working	Disconnect the power, restart the product
Water leakage	The connection between inlet pipe or outlet hose is not tight	Check and fasten water pipes Clean up outlet hose
Detergent residues in the box	Detergent is dampened or agglomerated	Clean and wipe the detergent box
Indicator or display does not light	Disconnect the power PC board or harness has connection problem	Check if the power is shut down and the power plug is connected correctly
Abnormal noise		Check if the fixing (bolts) have been removed Check it's installed on a solid and level floor

Description	Reason	Solution
E30	Door is not closed properly	Restart after the door is closed Check if the clothes is stuck
E10	Water injecting problem while washing	Check if the water pressure is too low Straighten the water pipe Check if the inlet valve filter is blocked
E21	Overtime water draining	Check if the drain hose is blocked
E12	Water overflow	Restart the washer
EXX	Others	Please try again first, call up service line if there are still troubles

Note!

- After the check, activate the appliance. If the problem occurs or the display shows other alarm codes again, contact the service.

MAINTENANCES

■ Technical Specifications

MAX.Current 10A

Standard Water Pressure 0.05MPa~1MPa

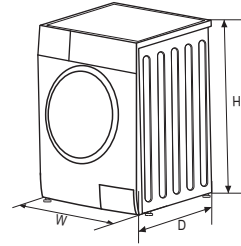

Model NA-S128M2*

Power Supply 220-240V~,50Hz

Washing Capacity 12.0kg

Drying Capacity 8.0kg

Dimension(W*D*H) 595*585*850

Weight 78kg

Rated Power 2000W

Drying Power 1300W

*WSA:White

*LSA:Silver



Panasonic Marketing Middle East & Africa FZE
P.O. Box 17985, Jebel Ali, Dubai, UAE
Website : www.panasonic.com

M0118-00
Printed in China