

## Owner's Manual <Operations> DVD Home Theater Sound System

Model No. SC-XH166  
SC-XH105



Unless otherwise indicated, illustrations in these operating instructions are of SC-XH166.



### **Firmware updates**

Panasonic is constantly improving the unit's firmware to ensure that our customers are enjoying the latest technology.

Panasonic recommends updating your firmware as soon as you are notified.

For details, refer to "Firmware updates" (⇒ 7) or

<http://panasonic.jp/support/global/cs/> (This site is in English only.)

Thank you for purchasing this product.

Please read these instructions carefully before using this product, and save this manual for future use.

Please also read through the "Owner's Manual <Setup>".

# Precautions

## WARNING

### Unit

To reduce the risk of fire, electric shock or product damage,

- Do not expose this unit to rain, moisture, dripping or splashing.
- Do not place objects filled with liquids, such as vases, on this unit.
- Use only the recommended accessories.
- Do not remove covers.
- Do not repair this unit by yourself. Refer servicing to qualified service personnel.
- Do not let metal objects fall inside this unit.
- Do not place heavy items on this unit.

### AC mains lead

To reduce the risk of fire, electric shock or product damage,

- Ensure that the power supply voltage corresponds to the voltage printed on this unit.
- Insert the mains plug fully into the socket outlet.
- Do not pull, bend, or place heavy items on the lead.
- Do not handle the plug with wet hands.
- Hold onto the mains plug body when disconnecting the plug.
- Do not use a damaged mains plug or socket outlet.

The mains plug is the disconnecting device.

Install this unit so that the mains plug can be unplugged from the socket outlet immediately.

### Speaker

To prevent injury, this apparatus must be securely attached to the wall in accordance with the installation instructions.

### Small object

- Keep the batteries out of reach of children to prevent swallowing.
- Keep the screws out of reach of children to prevent swallowing.

## CAUTION

### Unit

- This unit utilizes a laser. Use of controls or adjustments or performance of procedures other than those specified herein may result in hazardous radiation exposure.
- Do not place sources of naked flames, such as lighted candles, on this unit.
- This unit may receive radio interference caused by mobile telephones during use. If such interference occurs, please increase separation between this unit and the mobile telephone.
- This unit is intended for use in tropical climates.

### Placement

Place this unit on an even surface.

To reduce the risk of fire, electric shock or product damage,

- Do not install or place this unit in a bookcase, built-in cabinet or in another confined space. Ensure this unit is well ventilated.
- Do not obstruct this unit's ventilation openings with newspapers, tablecloths, curtains, and similar items.
- Do not expose this unit to direct sunlight, high temperatures, high humidity, and excessive vibration.

### Speaker

- **Use only supplied speakers**

The main unit and supplied speakers are to be used only as indicated in these operating instructions. Failure to do so may lead to damage to the amplifier and/or the speakers, and may result in the risk of fire. Consult a qualified service person if damage has occurred or if you experience a sudden change in performance.

- **XH166** Be careful not to cross (short-circuit) or reverse the polarity of the speaker wires as doing so may damage the speakers.
- Hold the speaker firmly to avoid injury by dropping the speaker when carrying.
- You can damage your speakers and shorten their useful life if you play sound at high levels over extended periods.
- Do not touch the front area of the speakers. Hold by the sides.
- Place speakers on flat, secure surfaces.
- To avoid injury by falling or dropping the speaker, place the speaker cables with care not to stumble or hook.
- Do not stand on the speaker. Be cautious when children are near.

### Batteries

Mishandling of batteries can cause electrolyte leakage and may cause a fire.

- Danger of explosion if battery is incorrectly replaced. Replace only with the type recommended by the manufacturer.
- When disposing of the batteries, please contact your local authorities or dealer and ask for the correct method of disposal.
- Do not mix old and new batteries or different types at the same time.
- Do not heat or expose to flame.
- Do not leave the battery(ies) in a car exposed to direct sunlight for a long period of time with doors and windows closed.
- Do not take apart or short circuit.
- Do not recharge alkaline or manganese batteries.
- Do not use batteries if the covering has been peeled off.

Remove batteries if you do not intend to use the remote control for a long period of time. Store in a cool, dark place.

## To dispose or transfer this unit

The unit may keep the user settings information in the unit. If you discard this unit either by disposal or transfer, then follow the procedure to return all the settings to the factory presets to delete the user settings. (→ 17, "To return all settings to the factory preset.")

- The operation history may be recorded in the memory of this unit.

### Information on Disposal in other Countries outside the European Union



This symbol is only valid in the European Union. If you wish to discard this product, please contact your local authorities or dealer and ask for the correct method of disposal.

## AC Mains Lead

### (For the AC mains plug of three pins)

#### How to replace the fuse

The location of the fuse differ according to the type of AC mains plug (figures A and B). Confirm the AC mains plug fitted and follow the instructions below.

Illustrations may differ from actual AC mains plug.

- 1 Open the fuse cover with a screwdriver.

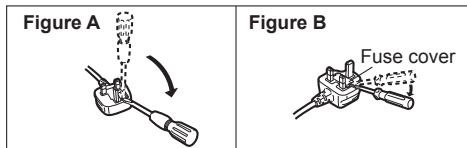

- 2 Replace the fuse and close or attach the fuse cover.

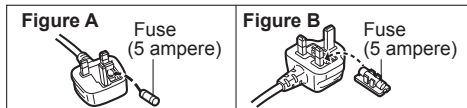

## Unit and media care

### Clean this unit with a soft, dry cloth

- Never use alcohol, paint thinner or benzene to clean this unit.
- Before using chemically treated cloth, carefully read the instructions that came with the cloth.

### Do not use commercially available lens cleaners as they may cause malfunction.

Cleaning of the lens is generally not necessary although this depends on the operating environment.

### Clean discs

DO

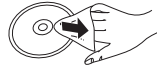

DO NOT



Wipe with a damp cloth and then wipe dry with a dry cloth.

## Disc handling precautions

- Handle discs by the edges to avoid inadvertent scratches or fingerprints on the disc.
- Do not attach labels or stickers to discs.
- Do not use disc cleaning sprays, benzene, thinner, static electricity prevention liquids or any other solvent.
- Do not use the following discs:
  - Discs with exposed adhesive from removed stickers or labels (rented discs, etc.).
  - Discs that are badly warped or cracked.
  - Irregularly shaped discs, such as heart shapes.

# Table of contents

Precautions . . . . . 2

## Getting started

Accessories . . . . . 4  
Package contents . . . . . 5  
Media information . . . . . 6  
Setting up the system . . . . . 7  
Firmware updates . . . . . 7  
Control reference guide . . . . . 8

## Basic operations

Enjoying TV with the speakers of the system . . . . . 10  
Playback . . . . . 10  
"HDMI CEC" . . . . . 11  
Listening to the Radio . . . . . 11  
Changing the sound settings . . . . . 12

## Advanced operations

Option menu . . . . . 13  
Setup menu . . . . . 13  
Speaker installation option . . . . . 16

## Reference

Troubleshooting guide . . . . . 17  
Specifications . . . . . 19

# Accessories

Check the supplied accessories before using this unit.

- 1 Remote control**  
(N2QAYB000974)

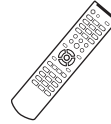

- 2 Batteries for remote control**



- 2 AC mains leads**



See page 7 for more information.

- 1 HDMI cable**



- 1 FM indoor antenna**



- XH166 1 Sheet of speaker cable sticker**



- Product numbers provided in these operating instructions are correct as of January 2014. These may be subject to change.
- Do not use AC mains lead with other equipment.

### ■ Using the remote control

Insert the batteries to the terminal so that it (+ and -) matches those in the remote control.

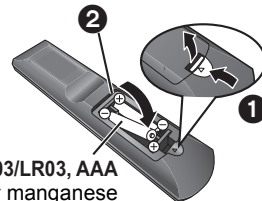

**R03/LR03, AAA**  
(Alkaline or manganese batteries)

# Package contents

Check the package contents before using this unit.

**XH166**

Main unit  
(SA-XH166)



FRONT  
(SB-HFS4810)



(Speakers)

SURROUND  
(SB-HFS4010)



CENTER  
(SB-HC4010)



(Speaker cables)

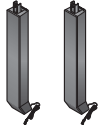

(Stands)

SUBWOOFER  
(SB-HW3010)



(Bases)



(Screws)

**XH105**

Main unit  
(SA-XH105)



FRONT  
(SB-HF3010)



SURROUND  
(SB-HS3010)



CENTER  
(SB-HC3010)



SUBWOOFER  
(SB-HW3010)



# Media information

## ■ Playable media

DVD-Video	Video
DVD-R	Video, Xvid, MOV, JPEG, MP3
DVD-R DL	JPEG, MP3
DVD-RW	Video
+R/+RW/+R DL	
Music CD	Music [CD-DA], VCD, SVCD
CD-R	Xvid, JPEG, MP3, VCD, SVCD
CD-RW	Music [CD-DA], VCD, SVCD
USB devices	Xvid, FLV, MOV, JPEG, MP3

## ■ Types of discs that cannot be played by this unit

Any other disc that is not specifically supported or previously described.

- Blu-ray Discs
- DVD-RAM
- Super Audio CD
- Photo CD
- DVD-Audio
- See page 19 for more information on the types of content that can be played.
- HD DVD
- WMA discs
- DivX discs
- AVCHD discs

## ■ Region management information

The unit can playback DVD-Video discs of the following regions codes, including "ALL":

Example:

**For South East Asia**



**For the Middle East and South Africa**



## ■ Finalize

Any DVD-R/RW/R DL, +R/+RW/+R DL and CD-R/RW that are recorded by a recorder need to be finalized by the recorder to play on this unit. Please refer to the recorder's instructions.

## ■ Music CD

Operation and sound quality of CDs that do not comply with CD-DA specifications (copy control CDs, etc.) cannot be guaranteed to work.

## ■ USB device

- This unit does not guarantee connection with all USB devices.
- This unit does not support USB device charging.
- FAT16, FAT32, and NTFS file systems are supported.
- This unit supports USB2.0 High Speed.
- This unit supports an HDD formatted in FAT32 and NTFS. If the HDD is not recognized, the power to the HDD may not be supplied. Supply power from an external source.



- It may not be possible to play the above media in some cases due to the type of media, the condition of the recording, the recording method, and how the files were created.
- The producers of the disc can control how discs are played, so you may not always be able to control play as described in these operating instructions. Read the disc's instructions carefully.

## Setting up the system

Follow the "Owner's Manual <Setup>" to set up the system first.

### Precautions

#### Speakers

- Keep your speakers at least 10 mm away from the system to avoid noise generated by resonance.
- For optional wall mount, refer to page 16.
- When you place all the speakers in a row at the front, set "5.1ch Front Layout" to "On". (⇒ 14)

#### Centre speaker

- Put it on a rack or shelf not to interfere with the TV's various sensors (ambient light, etc.).  
Vibration caused by the speaker can disrupt the picture if it is placed directly on the TV.

#### Surround speakers

- Place the speakers at the same height or higher than ear level.

#### HDMI

- If you use an optional HDMI cable, use the ARC\* compatible High Speed HDMI cables. Non-HDMI-compliant cables cannot be utilized. It is recommended that you use Panasonic's HDMI cable. When outputting 1080p signal, please use HDMI cables 5.0 meters or less.

---

\* ARC is an abbreviation of Audio Return Channel, also known as HDMI ARC. This feature allows a home theatre system to receive and play audio from the TV through a single HDMI cable without additional wiring.

#### VIDEO OUT

- **Do not make the video connections through the VCR.**

Due to copy guard protection, the picture may not display properly.

#### AC mains lead

2 AC mains leads are supplied.  
Use the AC mains lead that matches the socket for the area you live in.

- Saudi Arabia: 3-pin AC mains lead
- This unit consumes a small amount of AC power (⇒ 19) even when turned off in standby mode. For the purpose of energy conservation, the unit should be disconnected if you will not be using it for extended period of time.

## Firmware updates

Occasionally, Panasonic may release updated firmware for this unit that may add or improve the way a feature operates. These updates are available free of charge.

You can download the latest firmware from the following website and burn it to a CD-R to update the firmware.

<http://panasonic.jp/support/global/cs/>  
(This site is in English only.)

DO NOT DISCONNECT the unit from the AC power or perform any operation while the update is in process.

After the firmware is installed, "donE" will be displayed on the unit's display.

# Control reference guide

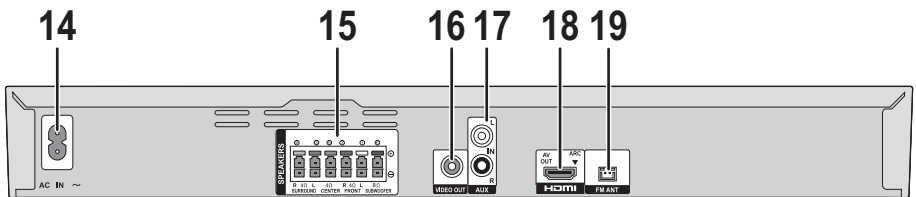
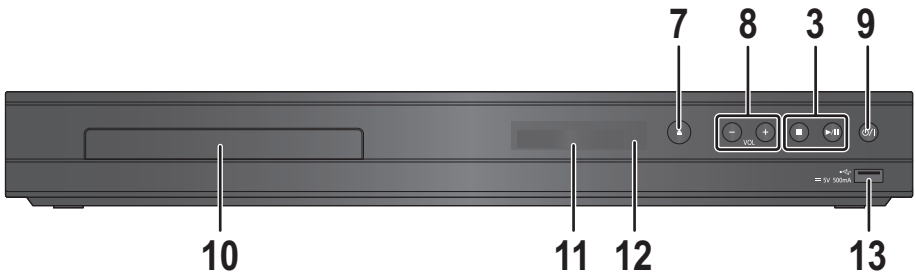
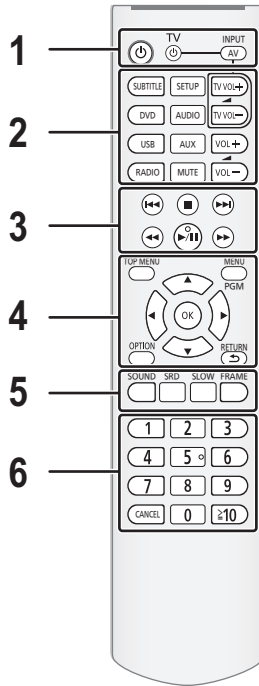



- 1 **[⏻]**  
Turn the unit on and off  
**[⏻ TV]**  
Turn the TV on and off  
**[AV, INPUT]**  
Switch the input select of TV
- 2 **[SUBTITLE]**  
Change the subtitle settings.  
**[DVD], [USB], [RADIO], [AUX]**  
Select an audio or video source  
**[SETUP]**  
Show Setup menu (⇒ 13)  
**[AUDIO]**  
Change the audio channel number or soundtrack language, etc.  
**[MUTE]**  
Mute the sound
  - “MUTE” flashes on the unit’s display, while the function is on.
  - To cancel, press the button again or adjust the volume.
  - Muting is cancelled if the unit is turned off.**[TV VOL + – ]**  
Adjust the volume of TV  
**[VOL + – ]**  
Adjust the volume of the main unit
- 3 **[▶/⏸] (Play/Pause)**  
Start or pause playback.  
**[■] (Stop)**  
Stops playback and remembers the resume point. (⇒ 10)  
**[◀◀] / [▶▶] (Skip)**  
Skip to the title, chapter or track.  
**[◀◀] / [▶▶] (Search)**  
Start fast reverse or fast forward.
- 4 **[TOP MENU]**  
Show Top Menu  
**[MENU]/[PGM]**  
Show Menu /  
Register radio broadcasts (⇒ 11) /  
Set the playback order of music tracks
  - ① Press **[▲, ▼, ◀, ▶]** to select the item.
  - ② Press [0] to [9] to specify the order.  
To cancel: Press [CANCEL].
  - ③ Press **[▲, ▼, ◀, ▶]** to select “PLAY”.  
To clear the whole program:  
Press **[▲, ▼, ◀, ▶]** to select “CLEAR”.
  - ④ Press [OK].
- [▲, ▼, ◀, ▶]**  
Move the highlight for selection  
**[OK]**  
Confirm the selection  
**[OPTION]**  
Show Option menu (⇒ 13)  
**[RETURN ↵]**  
Return to previous screen
- 5 **[SOUND]**  
Set the sound effects (⇒ 12)  
**[SRD]**  
Set the surround effects (⇒ 12)  
**[SLOW]**  
Start slow motion playback  
**[FRAME]**  
Play video frame-by-frame
- 6 Select title numbers, etc./Enter numbers  
**[CANCEL]:** Cancel
- 7 Open or close the disc tray (⇒ 10)
- 8 Adjust the volume of the main unit
- 9 **Standby/on switch (⏻/|)**  
Press to switch the unit from on to standby mode or vice versa. In standby mode, the unit is still consuming a small amount of power.
- 10 Disc tray
- 11 Display  
Unit’s display list (⇒ 18)
- 12 Remote control signal sensor  
Distance: Within approx. 7 m.  
Angle: Approx. 20° up and down, 30° left and right
- 13 USB port (⇒ 10)
- 14 AC IN terminal
- 15 Speaker terminals
- 16 VIDEO OUT terminal
- 17 AUX terminal
- 18 HDMI AV OUT (ARC) terminal
- 19 FM radio antenna terminal

# Enjoying TV with the speakers of the system

When the system is connected to the HDMI terminal of an ARC-compatible TV, the speakers of the system output the sound of the TV. If you are using other connection methods, such as one that uses an audio cable, follow the steps below.

## Press [AUX].



- Reduce the volume on the TV to its minimum, and then adjust the volume of the main unit.

# Playback

- 1 Turn on the TV and select the appropriate video input.
- 2 Press [⏪].
- 3 Insert the media.

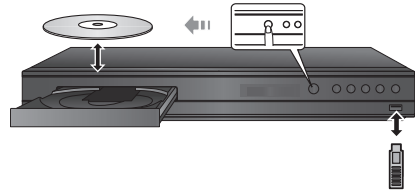

- When inserting a media item, ensure that it is facing the correct way, which is the right side facing up.

- 4 Press [DVD] or [USB].

Playback starts depending on the media.

- 5 Select the item to play and press [OK].

Repeat this step if necessary.

(JPEG only)

- If you press [▶/||] during picture playback, a slideshow will start.
- If the media contains a music file, the music will also be played back during picture playback.



- It is not possible to play back MPEG2 videos which have been dragged and dropped or copied and pasted to the media.
- To save on electricity, this unit is turned off automatically if there is no button operation for about 20 minutes when not playing back (such as when paused or displaying the menu, displaying still pictures, etc.).(⇒ 14, "Auto Standby")

## Stop

Press [■].

The stopping point is memorized.

### Resume play function

Press [▶/||] to restart from this point.

- The point is cleared if the media is removed.

## “HDMI CEC”

This unit supports “HDMI CEC” (Consumer Electronics Control) function.

See the operating instructions for connected equipment for operational details.

### Preparation

Set “HDMI CEC” to “On” (⇒ 13).  
(The default setting is “On”).

### Power on link

When the unit starts playback, the TV will automatically turn on and the screen of the unit will be displayed.

### Power Off Link

All connected “HDMI CEC” equipment automatically turns off when you switch the TV off.

### Playing music continuously even after turning off the TV

Select “Video” in “Power Off Link” (⇒ 14)



- The operation cannot be guaranteed on all HDMI CEC equipment.

## Listening to the Radio

You can preset up to 30 channels.

### Tuning and presetting

- 1 Press [RADIO].



Select a radio broadcast

- 2 Press [▲] or [▼] to select the frequency.
  - [▲]: Next frequency / [▼]: Previous frequency
  - Press [◀], [▶] to start automatic tuning. Tuning stops when a station is found.

To preset the channel

- 3 Press [PGM].



- 4 Press [◀◀] or [▶▶] to select a channel number.
- 5 Press [OK].

### Listening to a preset channel

- 1 Press [RADIO].
- 2 Press the number buttons to select the channel.
  - e.g., 01: [0] ⇒ [1].
  - 12: [1] ⇒ [2].Alternatively, press [◀◀] or [▶▶].

### To erase all the preset channels

- 1 Press [RADIO].
- 2 Press and hold [PGM].
  - “ErASE” is flashing on the unit’s display.
- 3 Press [OK].

# Changing the sound settings

## Sound Mode/Subwoofer Level

### ■ Sound Mode

Press [SOUND] to select the sound effect.

Each time you press [SOUND], the sound effect changes.

– Flat / Heavy / Clear / Soft

- You can also change the setting by pressing [▲, ▼] while a sound effect is displayed.

e.g.,



### ■ Subwoofer Level

1 Press [SOUND].

2 Press [◀, ▶] to select the settings.

You can adjust the amount of bass.

– “SUB 1” to “SUB 4”

- Levels can be set by source.



- The sound effects may not be available or have no effect with some sources.

## Surround Mode

Press [SRD] to select the surround effect.

Each time you press [SRD], the surround effect changes.

e.g.,



### “StAndArd” (Standard)

Sound is output as it was recorded/encoded.

Speaker output varies depending on the source.

### “MULTI CHAnnEL” (Multi Channel Out)

You can enjoy sound from the front speakers, as well as the surround speakers even when playing stereo sources.

### “MOVIE” (Dolby® Pro Logic II Movie)

Suitable for movie software, or the one recorded in Dolby® Surround.

### “MUSIC” (Dolby® Pro Logic II Music)

Add 5.1-channel effects to stereo sources.

### “StErEO” (Stereo)

You can play any source in stereo. Sound will be output to the front speakers and the subwoofer only.

# Option menu

A variety of playback operations and settings can be performed through this menu.

Available options differ depending on the playing contents and the condition of the unit.

## 1 Press [OPTION].

e.g.,

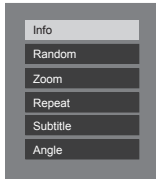

## 2 Select an item and change the settings.

### To exit the screen

Press [OPTION].

#### ■ Info

The status messages give you information about what is currently being played.

- Depending on the media, if you press [OPTION] while the screen is displayed, more information will be displayed.
- Depending on media and contents, the display may change or not appear.

e.g., DVD-Video



**A** Elapsed time in the title

#### ■ Random

Select whether or not to play randomly.

#### ■ Zoom

Videos and pictures are magnified.

#### ■ Repeat

Select the item that you want to repeat.

#### ■ Subtitle

Change the subtitle settings.

#### ■ Angle

Select the number of the angle.

# Setup menu

Change the unit's settings if necessary. The settings remain intact even if you switch the unit to standby.

## 1 Press [SETUP].

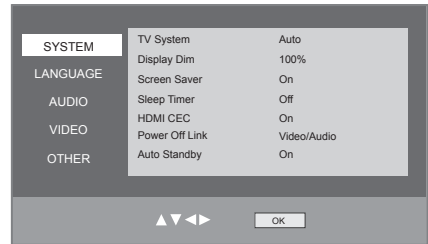

## 2 Select an item and change the settings.

### To exit the screen

Press [SETUP].

## SYSTEM

#### ■ TV System

Perform the setup so it matches the TV System of the connected TV.

#### ■ Display Dim

Changes the brightness of the unit's display.

#### ■ Screen Saver

This is to prevent image retention on the screen.

- When this is set to "On":

If a list of playback content is displayed and there is no operation for 10 minutes or more, the screen switches to Screen saver automatically.

- While playing and pausing, etc., this function is not available.

#### ■ Sleep Timer

Set the sleep timer.

#### ■ HDMI CEC

Set to use "HDMI CEC" function when connected to a device that supports "HDMI CEC".

## ■ Power Off Link

Select the desired power off link setting of this unit for HDMI CEC operation.

### Video/Audio

When the TV is turned off, this unit will turn off automatically.

### Video

When playing back audio only content, the unit will not turn off automatically.

## ■ Auto Standby

Switch the home theater to standby mode after 20 minutes of no activity when in disc or USB mode.

## LANGUAGE

### ■ OSD

Choose the language for menus and on-screen messages.

### ■ Audio

Choose the language for audio.

### ■ Subtitle

Choose the language for the subtitle.

### ■ Menu

Choose the language for the disc menus.

## AUDIO

### ■ HDMI Audio Out

This setting selects whether or not to output audio from HDMI.

### ■ Digital Audio Out

Select the audio signal to output.

- Select "PCM", when the connected equipment cannot decode the respective audio format.

This unit decodes the audio format and transmits to the connected equipment.

- If you do not make proper settings the audio may be static or noisy.

## ■ 5.1ch Front Layout

When you place all the speakers in a row at the front, adjust the settings to achieve optimum effects.

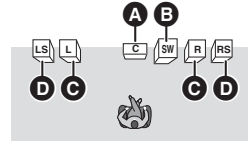

- A Centre speaker
- B Subwoofer
- C Front speakers
- D Surround speakers

## ■ Surround Mode

Set the surround effects. (⇒ 12)

## ■ Sound Mode

Set the sound effects. (⇒ 12)

## ■ Subwoofer Level

You can adjust the amount of bass. (⇒ 12)

## ■ Speaker

Press [OK] to show the following settings:

### > Speaker Level

Set the volume of each speaker.

### > Speaker Delay

For optimum listening with 5.1-channel sound, all the speakers, except for the subwoofer, should be the same distance from the seating position.

If either distance ① or ② is less than ③, measure the distance and adjust the time to make up for the difference (see the table below).

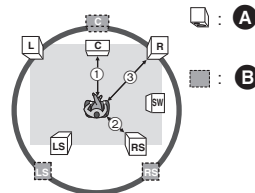

① ② ③: Primary listening distance

- A Actual speaker position
- B Ideal speaker position

### Delay time for the Centre speaker

Subtract the distance ① from ③

Distance (Approx.)	Setting
34 cm	1.0 ms
68 cm	2.0 ms
102 cm	3.0 ms
136 cm	4.0 ms
170 cm	5.0 ms

### Delay time for the Surround speakers

Subtract the distance ② from ③

Distance (Approx.)	Setting
170 cm	5.0 ms
340 cm	10.0 ms
510 cm	15.0 ms

### ➤ Test Tone

Each speaker will output a test signal sound in sequence.

### ■ Delay Time

Synchronization between picture and sound is corrected by adjusting the delay time of the audio output.

### ■ Dynamic Range

You can listen at low volumes but still hear dialogue clearly.

### ■ Whisper Mode

You can enhance the surround effect for low volume sound. (Convenient for late night viewing.)

## VIDEO

### ■ Resolution

Select suitable picture quality with your TV. (Video recordings will be converted to, and output as, high-definition video.)

- This works only when the HDMI connection is being used.

### ■ TV Type

Set to match the type of TV connected.

### ■ Picture Settings

Adjust the picture settings, such as the brightness and contrast.

- If you select "Personal", you can adjust the brightness, contrast and other items separately.

## OTHER

### ■ Rating

Set a rating level to limit DVD-Video play.

### ■ Password

Change the password for "Rating". You can enter the 4-digit password with the number buttons.

- The default password is "0000".

### ■ Default

This returns all values in the Setup menu and the Option menu to the default settings, except for some settings of ratings, on-screen language, etc.

# Speaker installation option

Consult a qualified building contractor when attaching the speakers to a wall. Improper attachment may result in damage to the wall and speakers and personal injury.

## Attaching to a wall

You can attach all of the speakers (except subwoofer) to a wall.

- The wall or pillar on which the speakers are to be attached should be capable of supporting 10 kg per screw.

### 1 Drive a screw (not supplied) into the wall.

- A** At least 30 mm
- B**  $\varnothing$  4.0 mm
- C**  $\varnothing$  7.0 mm to  $\varnothing$  9.4 mm
- D** Wall or pillar
- E** 5.5 mm to 7.5 mm

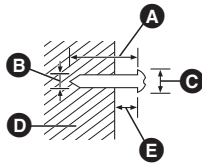

### 2 Fit the speaker securely onto the screw(s) with the hole(s).

e.g., XH166 Surround speaker	
DO NOT	DO
<ul style="list-style-type: none"> <li>• In this position, the speaker will likely fall if moved to the left or right.</li> </ul>	<ul style="list-style-type: none"> <li>• Move the speaker so that the screw is in this position.</li> </ul>

## Screwing positions on the wall

Use the measurements indicated below.

- Leave at least 20 mm of space above the speaker and 10 mm on each side to allow enough space for fitting the speaker.

**XH105**

### CENTER, FRONT, SURROUND

- A** 41 mm
- B** 28 mm

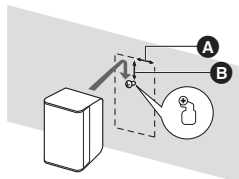

**XH166**

### CENTER

- A** 14 mm
- B** 65 mm
- C** 175 mm

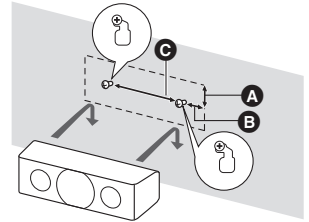

### FRONT

Attach to a wall without the base and the stand.

- Before using the speaker cable, remove it from the stand by pulling it out.

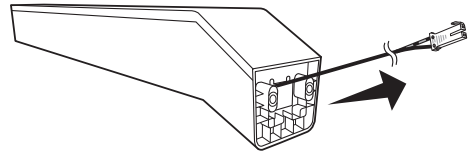

- D** 45 mm
- E** 53 mm
- F** 266 mm

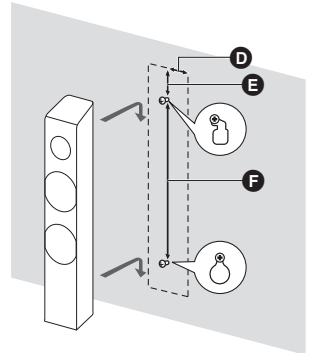

- Reattaching the speaker cable to the stand  
Straighten the cable and run through the stand. Pull out the cable through the hole.

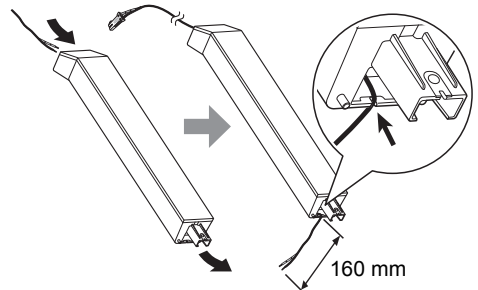



## SURROUND

- G 42 mm
- H 45 mm

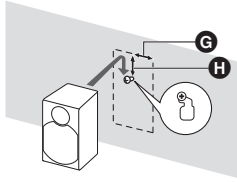

### To prevent tipping/falling of the speakers

#### Secure the speaker.

Using the tie down area on the rear of the speaker and a cord (not supplied), secure the speaker to a wall anchor (not supplied) permanently attached to the wall.

#### 1 Thread a cord to the speaker.

- Use a cord of less than  $\varnothing 2.0$  mm, which is capable of supporting over 10 kg.

e.g., **XH166** Front speaker

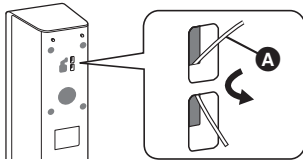

- A Cord (not supplied)

#### 2 Thread a cord from the wall to the speaker and tie tightly.

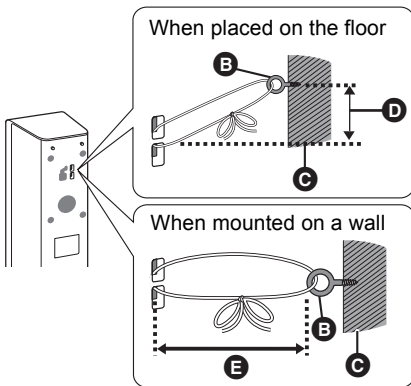

- B Wall anchor (not supplied)
- C Wall or pillar
- D Approx. 150 mm
- E Approx. 100 mm

## Troubleshooting guide

Before requesting service, please perform the following checks.

If the problem remains unresolved, consult your dealer for instructions.

### ■ Unit does not respond to remote control or unit's buttons.

Disconnect the AC mains lead, wait 1 minute, then reconnect the AC mains lead.

#### Do you have the latest firmware installed?

Panasonic is constantly improving the unit's firmware to ensure that our customers are enjoying the latest technology. (⇒ 7)

### The following do not indicate a problem with this unit:

- Regular disc rotating sounds.
- Image disturbance during search.

## General operation

### To return to the factory defaults.

- Select "Restore" in "Default" in the Setup menu. (⇒ 15)

### To return all settings to the factory preset.

- Reset the unit as follows:
  - ① Turn the unit on.
  - ② Press **[▲]** to open the disc tray.
  - ③ Press and hold **[■]** and **[▶/■]** on the main unit at the same time for more than 5 seconds.

### You have forgotten your ratings password. You want to cancel the ratings level.

- The ratings level returns to the factory defaults.
  - Restore the default settings following the steps described in "To return all settings to the factory preset." (⇒ above)

### This unit does not recognize the USB connection correctly.

- Disconnect and re-connect the USB cable. If it still does not recognize the connection, turn this unit off and on again.
- USB devices may not be recognized by this unit when connected using the following :
  - a USB hub
  - a USB extension cable
- If you connect USB HDD to this unit, use the USB cable that is supplied with the HDD.

## Picture

**The images from this unit do not appear on the TV.**

**Picture is distorted.**

**Jittering occurs.**

- The “Resolution” setting is incorrect or the “TV System” setting of the unit and that of the TV do not match.
  - Restore the default settings following the steps described in “To return all settings to the factory preset.” (⇒ 17)
- PAL discs cannot be correctly viewed on an NTSC TV.
- If irregular colouring occurs on your TV, turn the TV off for about 30 minutes. If it persists, move the speakers further away from the TV.

## Sound

**No sound.**

**Low volume.**

**Distorted sound.**

**Cannot hear the desired audio type.**

- Depending on the connected equipment, the sound may be distorted if this unit is connected with an HDMI cable.

## Playback

**Disc cannot be played.**

- The disc is dirty. (⇒ 3)

**Alternative subtitles cannot be selected.**

- You may not be able to use the Option menu to change the subtitles on some discs. Use the disc’s menus to make changes.

## Radio

**Distorted sound or noise is heard.**

- Adjust the position of the antenna.

**A beat sound is heard.**

- Try to keep a certain amount of distance between the antenna and the TV.

## Messages on the screen

**Error Disc**

- You inserted an incompatible disc.
- The disc may be upside down.

⊘ **This operation is not available.**

- Some operations are unsupported by the unit.

## Unit's display list

This list only contains displays that are difficult to read.

Display	Reading	Display	Reading
OFF	OFF	OPEN	OPEN
LOAD	LOAD	MUTE	MUTE
STOP	STOP	SETUP	SETUP
DISC	DISC	USB	USB
AUX	AUX	ERASE	ERASE
UPD	UPD (Update)	DONE	DONE
ERR	ERR (Error)	-----	No DISC, No PLAY, No READ, UNSUPPORT

# Specifications

## GENERAL

<b>Power consumption</b>	Approx. 41 W
<b>Power consumption in standby mode</b>	Approx. 0.5 W
<b>Power supply</b>	AC 220 V to 240 V, 50 Hz/60 Hz
<b>Dimensions (W×H×D)</b>	430 mm × 55 mm × 322 mm
<b>Mass</b>	Approx. 2.3 kg
<b>Operating temperature range</b>	0 °C to 40 °C
<b>Operating humidity range</b>	35 % to 80 % RH (no condensation)
<b>LASER Specification</b>	<b>Class 1 LASER Product</b> <b>Wave length:</b> 785 nm (CDs)/ 655 nm (DVDs) <b>Laser power:</b> No hazardous radiation is emitted with the safety protection

## AMPLIFIER SECTION

<b>RMS TTL POWER OUTPUT</b>	300 W
	1 kHz, 30 % total harmonic distortion
	FRONT: 50 W per ch (4 Ω)
	CENTRE: 50 W (4 Ω)
	SURROUND: 50 W per ch (4 Ω)
<b>Audio Input</b>	70 Hz, 30 % total harmonic distortion
	SUBWOOFER: 50 W (8 Ω)
	AUX × 1

## TERMINAL SECTION

<b>USB slot</b>	USB2.0 1 system
-----------------	--------------------

## FM TUNER SECTION

<b>Frequency range</b>	87.50 MHz to 108.00 MHz (50 kHz step)
<b>Antenna terminals</b>	1 with Antenna Cable (1.2 m)

## VIDEO SECTION

<b>Signal system</b>	PAL/NTSC
<b>Video output</b>	<b>Output level:</b> 1.0 V <sub>p-p</sub> (75 Ω) <b>Output connector:</b> Pin jack (1 system)
<b>HDMI AV output*</b>	<b>Output connector:</b> Type A (19 pin) 1 system

\* This unit supports "HDMI CEC" function.

## SPEAKER SECTION

	Woofer CONE TYPE (cm)	Full range CONE TYPE (cm)	Super tweeter Piezo type
<b>[XH166]</b>			
<b>Front</b>	—	6.5	×1
<b>Centre</b>	—	6.5	×2
<b>Surround</b>	—	6.5	×1
<b>Subwoofer</b>	16	—	—
<b>[XH105]</b>			
<b>Front</b>	—	6.5	—
<b>Centre</b>	—	6.5	—
<b>Surround</b>	—	6.5	—
<b>Subwoofer</b>	16	—	—

	Dimensions (W (mm)×H (mm)×D (mm))	Mass (Approx. kg)
<b>[XH166]</b>		
<b>Front</b>	270 × 1181 × 270	2.7
<b>Centre</b>	304 × 87 × 77	0.7
<b>Surround</b>	83 × 141 × 75	0.5
<b>Subwoofer</b>	156 × 290 × 263	3.1
<b>[XH105]</b>		
<b>Front</b>	81 × 126 × 74	0.43
<b>Centre</b>	81 × 126 × 74	0.43
<b>Surround</b>	81 × 126 × 74	0.43
<b>Subwoofer</b>	156 × 290 × 263	3.1

- The impedance of speakers:
  - Front speakers, Centre speaker, Surround speakers: 4 Ω.
  - Subwoofer: 8 Ω.

Specifications are subject to change without notice.

## File format

File format	Extension	Reference
<b>Xvid</b>	“.AVI”, “.avi”	<ul style="list-style-type: none"> <li>• The video file and subtitles text file are inside the same folder, and the file names are the same except for the file extensions.</li> <li>• Some Xvid files may not be played back correctly, depending on the video resolution, frame rate condition, subtitle format and so on.</li> </ul>
	Except South East Asia <b>Subtitles text file</b> “.SRT”, “.srt”, “.SUB”, “.sub”, “.TXT”, “.txt”	
<b>FLV</b>	“.FLV”, “.flv”	Some FLV/MOV files may not be played back correctly, depending on the video resolution, frame rate condition and so on.
<b>MOV</b>	“.MOV”, “.mov”	
<b>JPEG</b>	“.JPG”, “.jpg”, “.jpeg”	<ul style="list-style-type: none"> <li>• MOTION JPEG and Progressive JPEG are not supported.</li> <li>• You may not be able to play back the file if you have edited the folder structure or the file name on a PC or other device.</li> </ul>
<b>MP3</b>	“.MP3”, “.mp3”	This unit supports ID3 tags, but only titles, artist names and album names can be displayed.

- With certain recording states and folder structures, the play order may differ or playback may not be possible.

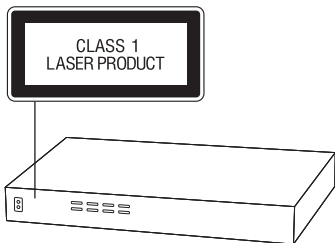

Manufactured under license from Dolby Laboratories. Dolby, Pro Logic, and the double-D symbol are trademarks of Dolby Laboratories.

---

For DTS patents, see <http://patents.dts.com>. Manufactured under license from DTS Licensing Limited. DTS, the Symbol, & DTS and the Symbol together are registered trademarks, and DTS 2.0+Digital Out is a trademark of DTS, Inc. © DTS, Inc. All Rights Reserved.

---

This item incorporates copy protection technology that is protected by U.S. patents and other intellectual property rights of Rovi Corporation. Reverse engineering and disassembly are prohibited.

---

HDMI, the HDMI Logo, and High-Definition Multimedia Interface are trademarks or registered trademarks of HDMI Licensing LLC in the United States and other countries.

---

MPEG Layer-3 audio coding technology licensed from Fraunhofer IIS and Thomson.

---

"DVD Logo" is a trademark of DVD Format/Logo Licensing Corporation.

---



---

Panasonic Corporation  
Web Site: <http://panasonic.net>

En

